

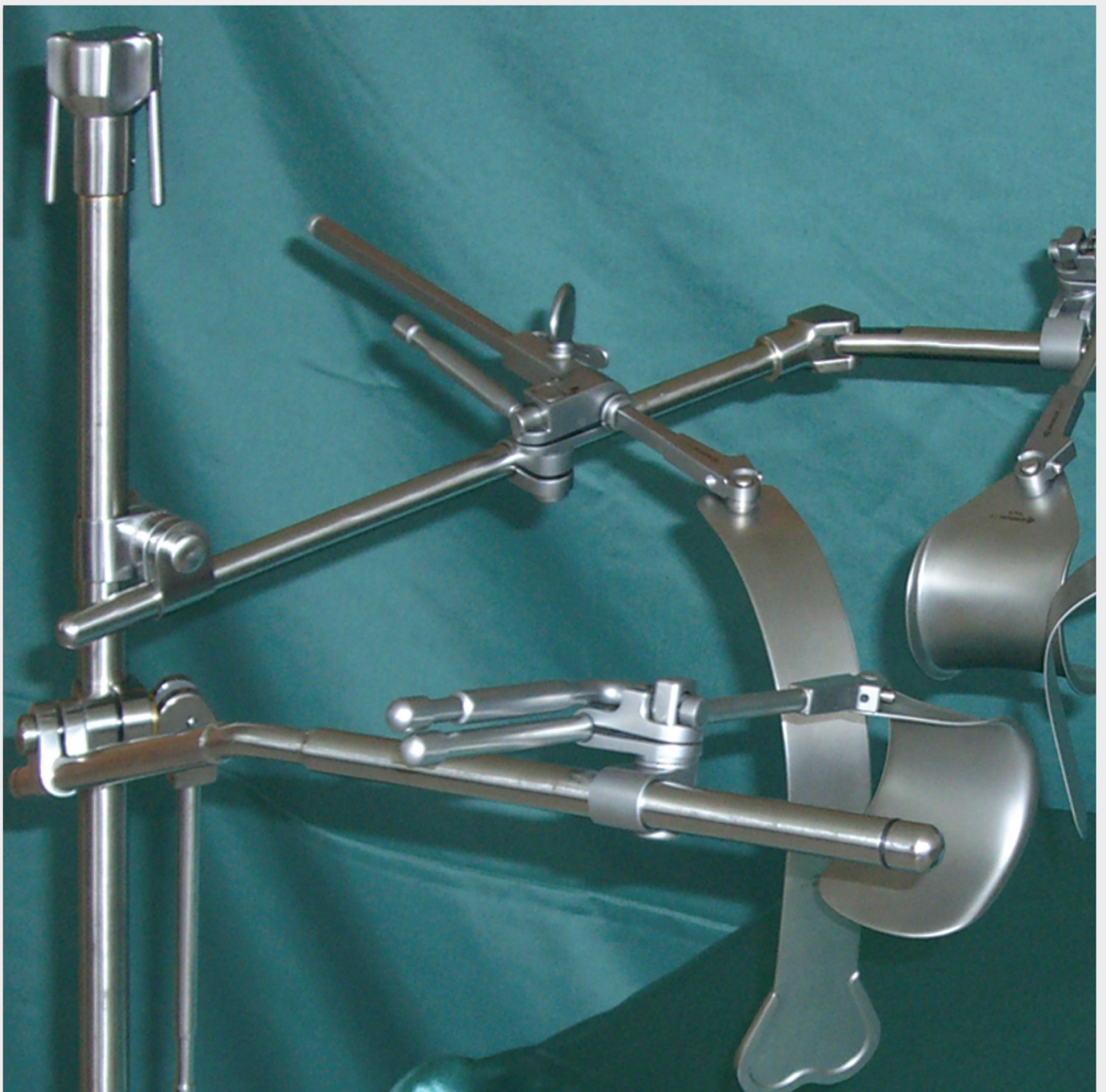

UNIVERSAL EKARTOR SETI
UNIVERSAL RETRACTOR SETS

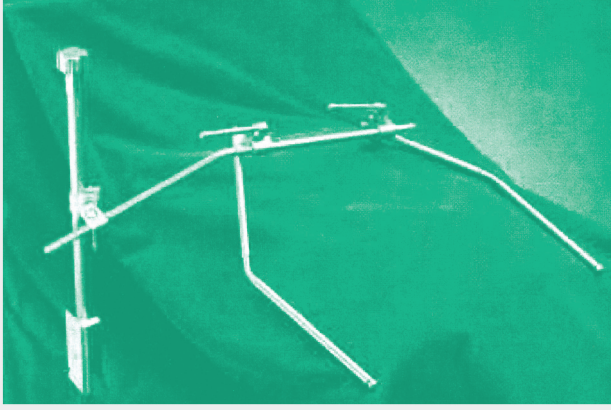



Universal Ekartör Seti

Universal Retractor System

Tek taraflı masa bağlantılı çatı kurulumu
Unilateral frame set up

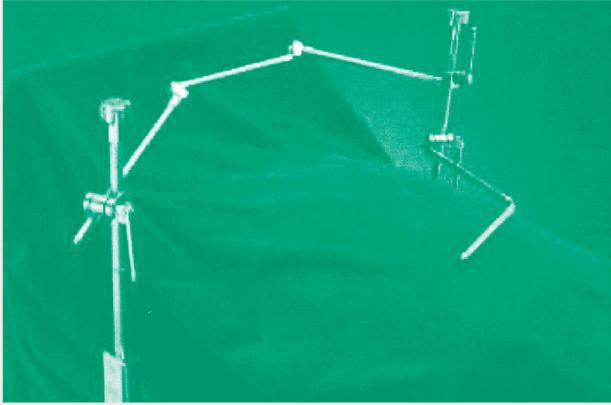

Universal Ekartör Seti

Universal Retractor System

İki taraflı masa bağlantılı çatı kurulumu
Bilateral frame set up

Universal Ekartör Seti

Kolay kurulur.

Operasyon sahasında rahat çalışma imkanı verir.

Birçok operasyonda kullanılır.

Geniş alet kullanım seçeneği sunar.

Pozisyona göre kurulabilme avantajı sağlar.

Asiste eleman sayısını azaltır.

Universal Retractor System

Easy to install.

Allows convenient working regard to operation field.

Can be used in various operations.

It provides wide range of instrument usage.

Provides use advantage depending on position.

Reduces the number of staff-assisted.



L 655.20
Çift bağlantılı çatı mili 60 cm
Cross bar with 2 cam joints 60 cm
(L 655.40 2 adet dahildir/Including 2 pieces of L 655.40)



L 655.21
Tek bağlantılı çatı mili 50 cm
Cross bar with single cam joint 50 cm
(L 655.40 1 adet dahildir/Including 1 pieces of L 655.40)



L 655.25 15 x 15 cm
L 655.26 30 x 30 cm
L 655.27 20 x 40 cm
L 655.28 20 x 30 cm
L 655.29 15 x 50 cm
Açılı çatı mili/Angled cross bar



L 655.10 45 cm
L 655.12 50 cm
Masa bağlantı ayağı
tek bağlantılı
Rail clamp with cam joint

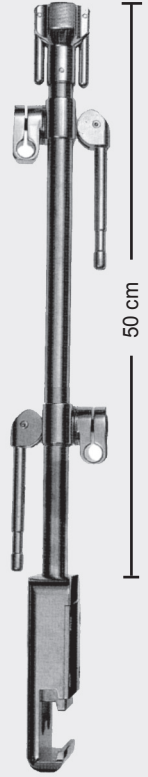

L 655.15 45 cm
L 655.17 50 cm
Masa bağlantı ayağı
çift bağlantılı
Rail clamp with two cam joints



L 655.30 30 cm
L 655.31 50 cm
Düz çatı mili/Straight arm



L 655.32 30 x 30 cm
Katlanabilir tek eklemler çatı mili
Hinged extension arm



L 655.33 28 x 21 x 28 cm
L 655.34 35 x 25 x 35 cm
Katlanabilir çift eklemler çatı mili
Bilateral crossbar.

L 655.40
Çatı bağlantı elemanı
Cam frame joint



L 655.42
Ekartör bağlantı elemanı
Retractor cam joint

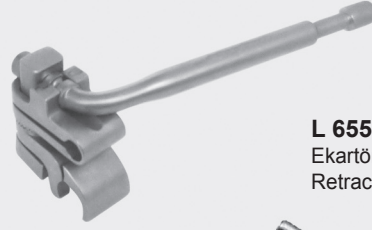

L 655.50
Işık taşıyıcı
Light carrier



L 655.55
Ekartör tutucu, bükülebilir
Flexible blade holder

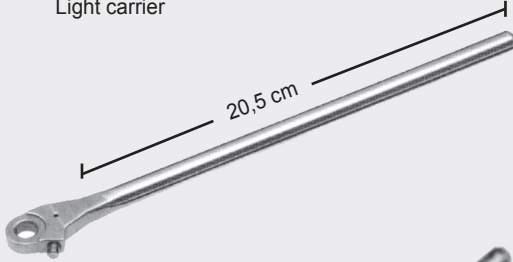
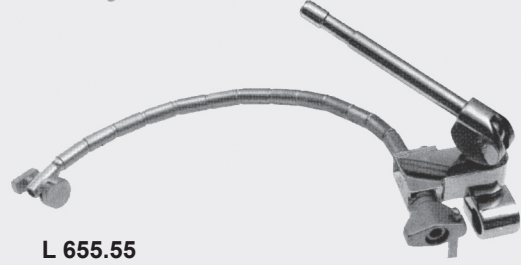

L 655.60
Ekartör kolu sabit
Retractor arm, straight

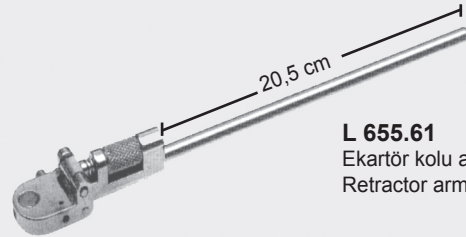

L 655.61
Ekartör kolu açısı ayarlanabilir
Retractor arm, adjustable angle

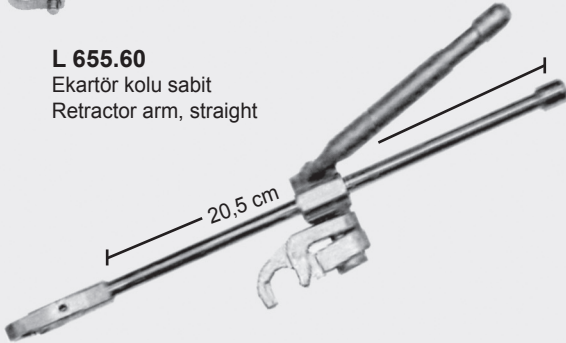

L 655.64
Ekartör kolu açısı ayarlanabilir,
bağlantı elemanı
Retractor arm, with cam joint,
adjustable angle

L 655.63
Ekartör kolu sabit bağlantı elemanı
Retractor arm, straight

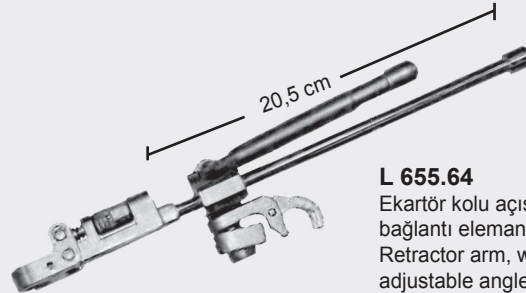
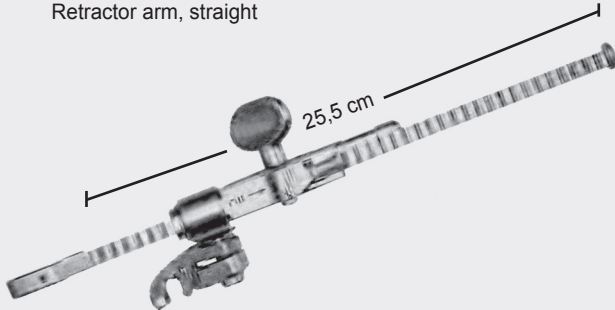

L 655.67
Ekartör kolu açısı ayarlanabilir,
bağlantı elemanı
Retractor arm, with cam joint,
adjustable angle

L 655.66
Ekartör kolu sabit bağlantı elemanı
Retractor arm with cam joint



Açısı ayarlanabilir ekartör kolu
Retractor arm with adjustable angle

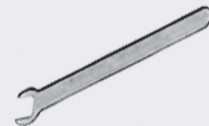

L 655.68
L 655.61-L 655.64-L 655.67
için açı değiştirme anahtarı
Angle adjusting wrench



L 656.00 65 x 13 mm
L 656.01 90 x 13 mm
L 656.02 150 x 13 mm
L 656.03 200 x 13 mm
L 656.04 100 x 25 mm
L 656.05 110 x 25 mm
L 656.06 130 x 25 mm
L 656.07 200 x 25 mm
L 656.08 250 x 25 mm
L 656.09 200 x 40 mm
L 656.10 250 x 40 mm
L 656.11 100 x 50 mm
L 656.12 200 x 50 mm
L 656.13 250 x 50 mm
L 656.14 250 x 65 mm
L 656.15 250 x 75 mm
L 656.16 250 x 100 mm
Bükülebilir, bleydler
Malleable, blades

**DEAVER**

L 656.20 125 x 25 mm
L 656.21 125 x 40 mm
L 656.22 125 x 50 mm
L 656.23 125 x 60 mm
L 656.24 125 x 80 mm
Bleydler/Blades



L 656.25 140 x 25 mm
L 656.26 200 x 25 mm
Damar bleydleri, bükülebilir
Vein blades, malleable



L 656.28 140 x 25 mm
L 656.29 200 x 25 mm
Damar bleydleri, bükülebilir
Vein blades, malleable

**HARRINGTON**

L 656.40 125 x 40 mm
L 656.41 100 x 65 mm
L 656.42 150 x 65 mm
L 656.43 200 x 65 mm
L 656.44 250 x 65 mm
Bleydler/Blades



L 656.45 150 mm
Bükülebilir parmak bleyd
Malleable finger blade

ST.MARKS

L **656.80** 140 x 65 mm
 L **656.81** 180 x 65 mm
 Pelvis bleyder/Pelvic blades

HEANY

L **656.83** 100 x 25 mm
 L **656.84** 130 x 25 mm
 Bleydler/Blades

FENCE

L **656.50** 110 x 50 mm
 L **656.51** 150 x 50 mm
 L **656.52** 100 x 100 mm
 L **656.53** 125 x 100 mm
 L **656.54** 150 x 100 mm
 L **656.55** 200 x 100 mm
 Bleydler/Blades

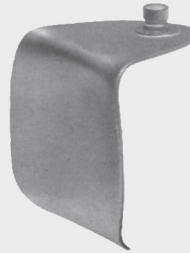
KELLY

L **656.60** 50 x 40 mm
 L **656.61** 60 x 50 mm
 L **656.62** 70 x 60 mm
 L **656.63** 90 x 80 mm
 Bleydler/Blades

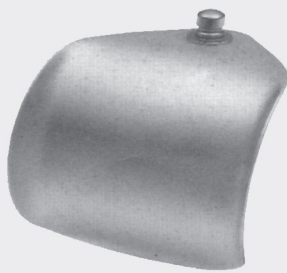
BALFOUR

L **656.30** 30 x 30 mm
 L **656.31** 30 x 50 mm
 L **656.32** 60 x 50 mm
 L **656.33** 50 x 70 mm
 L **656.34** 75 x 70 mm
 L **656.35** 60 x 80 mm
 L **656.36** 75 x 80 mm
 L **656.37** 125 x 80 mm
 L **656.38** 150 x 90 mm
 L **656.39** 60 x 100 mm
 Orta bleydler/Center blades

BALFOUR

L **656.67** 90 mm
 L **656.68** 130 mm
 Bleydler/Blades

RICHARDSON

L **656.70** 25 x 20 mm
 L **656.71** 50 x 20 mm
 L **656.72** 30 x 25 mm
 L **656.73** 50 x 45 mm
 Mini bleydler/Mini blades

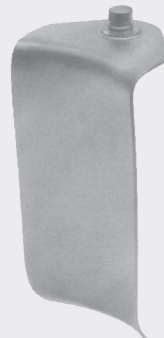
RICHARDSON

L **656.75** 75 x 50 mm
 L **656.76** 100 x 50 mm
 L **656.77** 125 x 50 mm
 L **656.78** 150 x 50 mm
 L **656.79** 170 x 50 mm
 Bleydler/Blades

**MURPHY**

Tırmık bleydler/Rake blades

L 657.10 13 x 19 mm

Sivri/Sharp

L 657.11 13 x 19 mm

Künt/Blunt

L 657.12 13 x 25mm

Sivri/Sharp

L 657.13 13 x 25 mm

Künt/Blunt

**VOLKMAN**

Bleydler/Blades

L 657.00 13 x 16 mm

Sivri/Sharp

L 657.01 13 x 16 mm

Künt/Blunt

L 657.02 13 x 25 mm

Sivri/Sharp

L 657.03 13 x 25 mm

Künt/Blunt

**HILL-FERGUSON****L 656.90** 65 x 25 mm**L 656.91** 75 x 30 mm

Rektal bleydler/Rectal blades

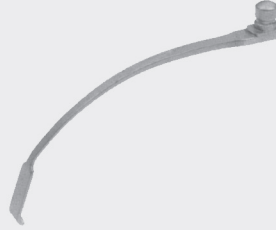
**HARRIS****L 656.49**

Prostat bleyd/Prostate blades

**L 656.98** 65 x 25 mm

Çift taraflı açılı oyuk bleyd

Double angled pocket blades

**L 656.94** 70 x 13 mm**L 656.95** 75 x 13 mm**L 656.96** 65 x 25 mm**L 656.97** 75 x 25 mm

Çift taraflı açılı bleydler

Double angled blades

**L 656.46** 130 x 80 mm

'Y' şeklinde mesane bleyd

'Y' bladder blade

**HOLTGREWE****L 656.47** 150 x 60 mm

Bleyd/Blade

MEYERDING

- L 657.20 50 x 16 mm
- L 657.21 75 x 16 mm
- L 657.22 100 x 16 mm
- L 657.23 50 x 25 mm
- L 657.24 75 x 25 mm
- L 657.25 100 x 25 mm

Bleyd/Blade

MEYERDING

- L 657.30 50 x 16 mm
- L 657.31 75 x 16 mm
- L 657.32 100 x 16 mm
- L 657.33 50 x 25 mm
- L 657.34 75 x 25 mm
- L 657.35 100 x 25 mm

Bleyd/Blade



- L 657.40 80 x 20 mm
 - L 657.41 80 x 45 mm
 - L 657.42 80 x 60 mm
 - L 657.43 100 x 20 mm
 - L 657.44 100 x 45 mm
 - L 657.45 100 x 60 mm
 - L 657.46 120 x 20 mm
 - L 657.47 120 x 45 mm
 - L 657.48 120 x 60 mm
- İçe bükümlü posterior lumbar bleyd
Concave posterior lumbar blades



- L 657.80 75 mm
 - L 657.81 100 mm
- Sivri uçlu bleydler
Prong blades

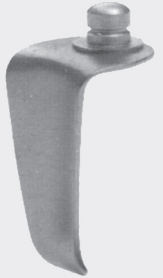

- L 657.50 40 x 16 mm
 - L 657.51 45 x 16 mm
 - L 657.52 50 x 16 mm
 - L 657.53 55 x 16 mm
 - L 657.54 60 x 16 mm
- Bleyd/Blade



- L 657.55 40 x 16 mm
 - L 657.56 45 x 16 mm
 - L 657.57 50 x 16 mm
 - L 657.58 55 x 16 mm
 - L 657.59 60 x 16 mm
- Bleyd/Blade

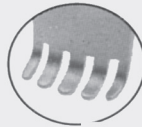

- L 657.70 55 x 20 mm
 - L 657.71 30 x 25 mm
 - L 657.72 40 x 25 mm
 - L 657.73 50 x 25 mm
 - L 657.74 60 x 25 mm
 - L 657.75 70 x 25 mm
 - L 657.76 80 x 25 mm
- Lumbar ekartör eğri uclu
Lumbar retractor curved point



- L 657.60 50 x 13 mm
 - L 657.61 75 x 13 mm
 - L 657.62 100 x 13 mm
 - L 657.63 50 x 19 mm
 - L 657.64 75 x 19 mm
 - L 657.65 100 x 19 mm
 - L 657.66 50 x 25 mm
 - L 657.67 75 x 25 mm
 - L 657.68 100 x 25 mm
- Lumbar ekartör düz uclu
Lumbar retractor staright point



- L 657.85
- Sinir kökü ekartörü
Nerve root retractor



- L 657.86
- Sinir kökü ekartörü
Nerve root retractor

- L 657.90 100 x 25 mm
 - L 657.91 150 x 25 mm
 - L 657.92 200 x 25 mm
 - L 657.93 250 x 25 mm
 - L 657.94 100 x 30 mm
 - L 657.95 150 x 30 mm
 - L 657.96 200 x 30 mm
 - L 657.97 250 x 30 mm
- Anterior lumbar bleydler
Anterior lumbar blades

L 659.00 Genel Çatı Seti Komple/General Blade Kit Complete
Tüm setlerde ortak kullanılır/Commonly Used in All Sets

001 L 655.10	MASA BAĞLANTI AYAĞI TEK BAĞLANTILI 45 CM	1 ADET
002 L 655.20	ÇİFT BAĞLANTILI ÇATI MİLİ 60 CM	1 ADET
003 L 655.63	EKARTÖR KOLU BAĞLANTI ELEMANI 25 CM	2 ADET
004 L 655.64	EKARTÖR KOLU AÇI AYARLANALIR BAĞLANTI ELEMANI 25 CM	2 ADET
005 L 655.66	EKARTÖR KOLU BAĞLANTI ELEMANI 25 CM	2 ADET
006 L 655.67	EKARTÖR KOLU AÇI AYARLANALIR BAĞLANTI ELEMANI 25 CM	2 ADET
007 L 655.68	L 655.61-64-67 İÇİN AÇI DEĞİŞTİRME ANAHTARI	1 ADET
008 L 655.26	AÇILI ÇATI MİLİ 30 x 30 CM	2 ADET
009 L 655.28	AÇILI ÇATI MİLİ 20 x 30 CM	2 ADET
010 L 655.27	AÇILI ÇATI MİLİ 20 x 40 CM	2 ADET
011 L 655.50	IŞIK TAŞIYICI	1 ADET
012 Y 885.00	TAŞIMA KONTEYNER 670X260X102 MM	1 ADET

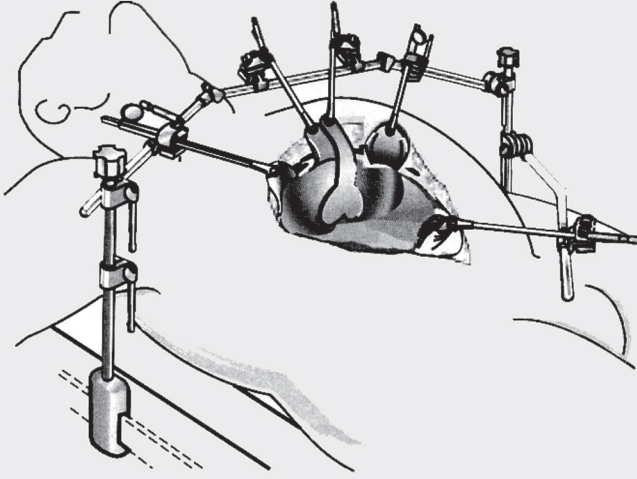
L 659.01 Karaciğer Transplantasyon Seti Komple
Liver Transplant Sytem Complete

001 L 655.33	KATLANIR ÇİFT EKLEM ÇATI MİLİ 28X21X28 CM	1 ADET
002 L 655.15	MASA BAĞLANTI AYAGI ÇİFT BAĞLANTILI 45 CM	1 ADET
003 L 656.01	BÜKÜLEBİLİR EKARTÖR 90X13 MM	2 ADET
004 L 656.02	BÜKÜLEBİLİR EKARTÖR 150X13 MM	2 ADET
005 L 656.03	BÜKÜLEBİLİR EKARTÖR 200X13 MM	2 ADET
006 L 656.04	BÜKÜLEBİLİR EKARTÖR 100X25 MM	2 ADET
007 L 656.05	BÜKÜLEBİLİR EKARTÖR 110X25 MM	2 ADET
008 L 656.11	BÜKÜLEBİLİR EKARTÖR 100X50 MM	2 ADET
009 L 656.14	BÜKÜLEBİLİR EKARTÖR 250X65 MM	2 ADET
010 L 656.15	BÜKÜLEBİLİR EKARTÖR 250X75 MM	2 ADET
011 L 656.16	BÜKÜLEBİLİR EKARTÖR 250X100 MM	2 ADET
012 L 656.62	KELLY EKARTÖR 70X60 MM	1 ADET
013 L 656.63	KELLY EKARTÖR 90X80 MM	2 ADET
014 L 656.34	BALFOUR EKARTÖR 75X70 MM	2 ADET
015 L 656.36	BALFOUR EKARTÖR 75X80 MM	2 ADET
016 L 656.30	BALFOUR EKARTÖR 30X30 MM	4 ADET
017 L 656.79	RICHARDSON EKARTÖR 170X50 MM	1 ADET
018 L 656.42	HARRINGTON EKARTÖR 150X65 MM	1 ADET
019 L 656.81	ST.MARKS PELVİS EKARTÖRÜ 180X65 MM	1 ADET
020 L 656.45	PARMAK EKARTÖR 150 MM	2 ADET
021 L 656.35	BALFOUR EKARTÖR 60X80 MM	1 ADET
022 L 656.39	BALFOUR EKARTÖR 60X100 MM	1 ADET
023 L 656.37	BALFOUR EKARTÖR 125X80 MM	1 ADET
024 L 655.10	MASA BAĞLANTI AYAĞI TEK BAĞLANTILI 45 CM	1 ADET
025 L 655.20	ÇİFT BAĞLANTI ÇATI MİLİ 60 CM	1 ADET
026 L 655.42	EKARTÖR BAĞLANTI ELEMANI	6 ADET
027 L 655.60	EKARTÖR KOLU SABİT 25 CM	5 ADET
028 Y 885.00	TAŞIMA KONTEYNER 670X260X102 MM	1 ADET

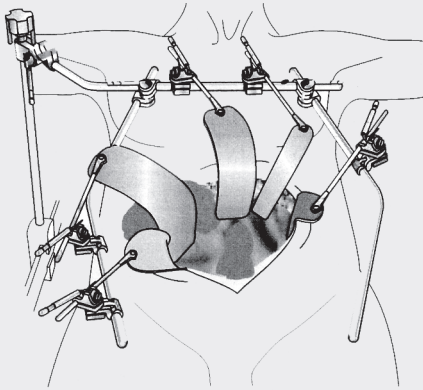
L 659.02 Genel Cerrahi Ekartör Seti Komple
General Surgery Retractor System Complete

001	L 656.07	BÜKÜLEBİLİR EKARTÖR 200X25 MM	1 ADET
002	L 656.28	DAMAR EKARTÖRÜ BÜKÜLEBİLİR 140X25 MM	1 ADET
003	L 656.12	BÜKÜLEBİLİR EKARTÖR 200X50 MM	2 ADET
004	L 656.14	BUKULEBİLİR EKARTÖR 250X65 MM	1 ADET
005	L 656.15	BUKULEBİLİR EKARTÖR 250X75 MM	1 ADET
006	L 656.70	RICHARDSON EKARTÖR 25X20 MM	1 ADET
007	L 656.62	KELLY EKARTÖR 70x60 MM	1 ADET
008	L 656.52	FENCE EKARTÖR 100X100 MM	1 ADET
009	L 656.53	FENCE EKARTÖR 125X100 MM	1 ADET
010	L 656.54	FENCE EKARTÖR 150X100 MM	1 ADET
011	L 656.33	BALFOUR EKARTÖR 50X70 MM	1 ADET
012	L 656.34	BALFOUR EKARTÖR 75X70 MM	1 ADET
013	L 656.67	BALFOUR EKARTÖR 90 MM	2 ADET
014	L 656.77	RICHARDSON EKARTÖR 125X90 MM	2 ADET
015	L 656.42	HARRINGTON EKARTÖR 150X65 MM	1 ADET
016	L 656.22	DEAVER EKARTÖR 125X50 MM	1 ADET
017	L 656.81	ST. MARKS PELVİS EKARTÖRÜ 180X65 MM	1 ADET
018	L 656.45	PARMAK EKARTÖR 150 MM	1 ADET
019	L 656.34	BALFOUR EKARTÖR 75X70 MM	1 ADET
020	L 656.38	BALFOUR EKARTÖR 150X90 MM	1 ADET
021	L 655.10	MASA BAĞLANTI AYAĞI TEK BAĞLANTILI 45 CM	1 ADET
022	L 655.20	ÇİFT BAĞLANTI ÇATI MİLİ 60 CM	1 ADET
023	L 655.26	AÇILI ÇATI MİLİ 30X30 CM	2 ADET
024	L 655.42	EKARTÖR TUTUCU BAĞLANTI ELEMANI	5 ADET
025	L 655.60	EKARTÖR KOLU SABİT 25 CM	5 ADET
026	Y 885.00	TAŞIMA KONTEYNER 670X260X102 MM	1 ADET

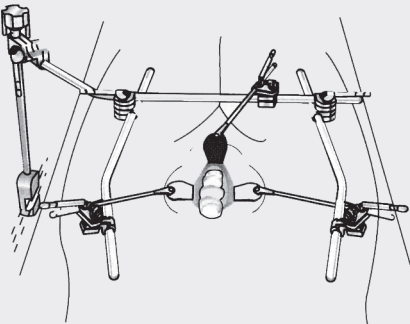
L 659.03 Kolon /Rektal Ekartör Seti Komple
Clon/Rectal Retractor System Complete

001	L 656.67	BALFOUR EKARTÖR 90 MM	2 ADET
002	L 656.20	DEAVER EKARTÖR 125X25 MM	2 ADET
003	L 656.91	HILL-FERGUSON REKTUM EKARTÖRÜ 75X30 MM	1 ADET
004	L 656.90	HILL-FERGUSON REKTUM EKARTÖRÜ 65X25 MM	1 ADET
005	L 656.81	ST. MARKS PELVİS EKARTÖRÜ 180X65 MM	1 ADET
006	L 655.10	MASA BAĞLANTI AYAĞI TEK BAĞLANTILI 45 CM	1 ADET
007	L 655.20	ÇİFT BAĞLANTI ÇATI MİLİ 60 CM	1 ADET
008	L 655.28	AÇILI ÇATI MİLİ 20X30 CM	2 ADET
009	L 655.42	EKARTÖR TUTUCU BAĞLANTI ELEMANI	3 ADET
010	L 655.60	EKARTÖR KOLU SABİT 25 CM	3 ADET
011	Y 885.00	TAŞIMA KONTEYNER 670X260X102 MM	1 ADET

L 659.04 Pediatric Ekartör Seti Komple
Pediatric Retractor System Complate

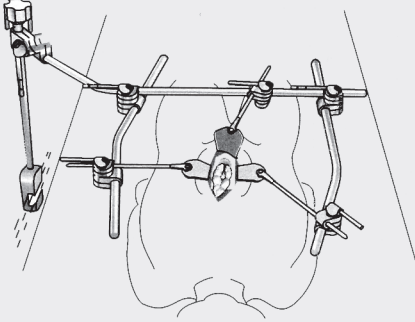

001	L 656.00	BÜKÜLEBİLİR EKARTÖR 65X13 MM	2 ADET
002	L 656.02	BÜKÜLEBİLİR EKARTÖR 150X13 MM	2 ADET
003	L 656.03	BÜKÜLEBİLİR EKARTÖR 200X13 MM	2 ADET
004	L 656.04	BÜKÜLEBİLİR EKARTÖR 100X25 MM	2 ADET
005	L 656.11	BÜKÜLEBİLİR EKARTÖR 100X50 MM	2 ADET
006	L 656.70	RICHARDSON EKARTÖR 25X20 MM	1 ADET
007	L 656.71	RICHARDSON EKARTÖR 50X20 MM	1 ADET
008	L 656.72	RICHARDSON EKARTÖR 30X25 MM	1 ADET
009	L 656.60	KELLY EKARTÖR 50X40 MM	1 ADET
010	L 656.61	KELLY EKARTÖR 60X50 MM	1 ADET
011	L 656.32	BALFOUR EKARTÖR 60X50 MM	1 ADET
012	L 656.30	BALFOUR EKARTÖR 30X30 MM	2 ADET
013	L 656.31	BALFOUR EKARTÖR 30X50 MM	1 ADET
014	L 656.76	RICHARDSON EKARTÖR 100X50 MM	1 ADET
015	L 656.42	HARRINGTON EKARTÖR 150X65 MM	1 ADET
016	L 656.20	DEAVER EKARTÖR 125X25 MM	1 ADET
017	L 655.10	MASA BAĞLANTI AYAĞI TEK BAĞLANTILI 45 CM	1 ADET
018	L 655.20	ÇİFT BAĞLANTI ÇATI MİLİ 60 CM	1 ADET
019	L 655.25	AÇILI ÇATI MİLİ 15X15 CM	2 ADET
020	L 655.42	EKARTÖR TUTUCU BAĞLANTI ELEMANI	3 ADET
021	L 655.60	EKARTÖR KOLU SABİT 25 CM	3 ADET
022	Y 885.00	TAŞIMA KONTEYNER 670X260X102 MM	1 ADET

L 659.05 Genel /Vasküler Cerr.Ekartör Seti Komple
General/Vascular Surgery Retractor System Complate

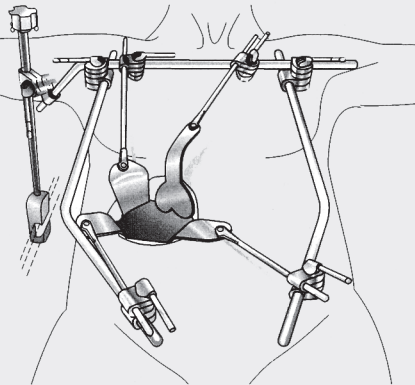

001	L 656.12	BÜKÜLEBİLİR EKARTÖR 200X50 MM	1 ADET
002	L 656.14	BÜKÜLEBİLİR EKARTÖR 250X65 MM	1 ADET
003	L 656.62	KELLY EKARTÖR 70X60 MM	1 ADET
004	L 656.63	KELLY EKARTÖR 90X80 MM	1 ADET
005	L 656.54	FENCE EKARTÖR 150X100 MM	1 ADET
006	L 656.33	BALFOUR EKARTÖR 50X70 MM	2 ADET
007	L 656.77	RICHARDSON EKARTÖR 125X50 MM	1 ADET
008	L 656.42	HARRINGTON EKARTÖR 150X65 MM	1 ADET
009	L 656.22	DEAVER EKARTÖR 125X50 MM	1 ADET
010	L 655.10	MASA BAĞLANTI AYAĞI TEK BAĞLANTILI 45 CM	1 ADET
011	L 655.20	ÇİFT BAĞLANTI ÇATI MİLİ 60 CM	1 ADET
012	L 655.27	AÇILI ÇATI MİLİ 20X40 CM	2 ADET
013	L 655.42	EKARTÖR TUTUCU BAĞLANTI ELEMANI	4 ADET
014	L 655.60	EKARTÖR KOLU SABİT 25 CM	4 ADET
015	Y 885.00	TAŞIMA KONTEYNER 670X260X102 MM	1 ADET

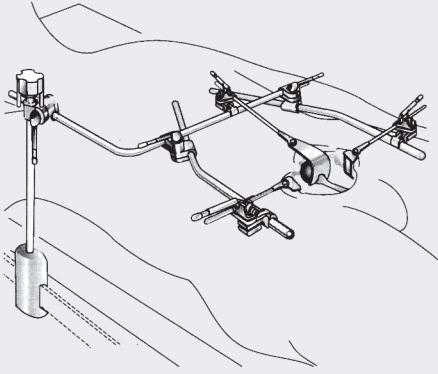
L 659.06 Abdominal Uroloji Ekartör Seti Komple
Abdominal Urology Retractor System
Complate

001	L 656.12	BÜKÜLEBİLİR EKARTÖR 200X50 MM	1 ADET
002	L 656.14	BÜKÜLEBİLİR EKARTÖR 250X65 MM	1 ADET
003	L 656.62	KELLY EKARTÖR 70X60 MM	2 ADET
004	L 656.54	FENCE EKARTÖR 150X100 MM	1 ADET
005	L 656.47	HOLTGREWE EKARTÖR 150X60 MM	1 ADET
006	L 656.32	BALFOUR EKARTÖR 60X50 MM	2 ADET
007	L 656.31	BALFOUR EKARTÖR 50X30 MM	2 ADET
008	L 656.67	BALFOUR EKARTÖR 90 MM	2 ADET
009	L 656.77	RICHARDSON EKARTÖR 125X50 MM	1 ADET
010	L 656.42	HARRINGTON EKARTÖR 150X65 MM	1 ADET
011	L 656.43	HARRINGTON EKARTÖR 200X65 MM	1 ADET
012	L 656.20	DEAVER EKARTÖR 125X25 MM	1 ADET
013	L 655.10	MASA BAĞLANTI AYAĞI TEK BAĞLANTILI 45 CM	1 ADET
014	L 655.20	ÇİFT BAĞLANTI ÇATI MİLİ 60 CM	1 ADET
015	L 655.26	AÇILI ÇATI MİLİ 30X30 CM	2 ADET
016	L 655.42	EKARTÖR TUTUCU BAĞLANTI ELEMANI	4 ADET
017	L 655.60	EKARTÖR KOLU SABİT 25 CM	4 ADET
018	Y 885.00	TAŞIMA KONTEYNER 670X260X102 MM	1 ADET

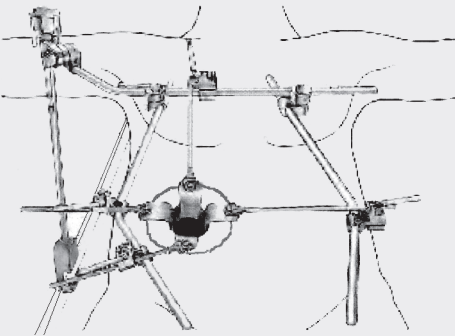
L 659.07 Böbrek Transplantasyon Ek.Seti Komple
Kidney Transplantation Retractor System
Complate

001	L 656.07	BÜKÜLEBİLİR EKARTÖR 200X25 MM	2 ADET
001	L 656.12	BÜKÜLEBİLİR EKARTÖR 200X50 MM	2 ADET
002	L 656.14	BÜKÜLEBİLİR EKARTÖR 250X65 MM	2 ADET
003	L 656.15	BÜKÜLEBİLİR EKARTÖR 250X75 MM	2 ADET
004	L 656.70	RICHARDSON EKARTÖR 25X20 MM	1 ADET
005	L 656.71	RICHARDSON EKARTÖR 50X20 MM	1 ADET
006	L 656.72	RICHARDSON EKARTÖR 30X25 MM	1 ADET
007	L 656.60	KELLY EKARTÖR 50X40 MM	1 ADET
008	L 656.61	KELLY EKARTÖR 60X50 MM	1 ADET
009	L 656.62	KELLY EKARTÖR 70X60 MM	1 ADET
010	L 656.32	BALFOUR EKARTÖR 60X50 MM	2 ADET
011	L 656.31	BALFOUR EKARTÖR 30X50 MM	2 ADET
012	L 656.76	RICHARDSON EKARTÖR 100X50 MM	1 ADET
013	L 656.77	RICHARDSON EKARTÖR 125X50 MM	1 ADET
014	L 656.42	HARRINGTON EKARTÖR 150X65 MM	1 ADET
015	L 655.10	MASA BAĞLANTI AYAĞI TEK BAĞLANTILI 45 CM	1 ADET
016	L 655.20	ÇİFT BAĞLANTI ÇATI MİLİ 60 CM	1 ADET
017	L 655.27	AÇILI ÇATI MİLİ 20X40 CM	2 ADET
019	L 655.42	EKARTÖR TUTUCU BAĞLANTI ELEMANI	4 ADET
020	L 655.60	EKARTÖR KOLU SABİT 25 CM	4 ADET
021	Y 885.00	TAŞIMA KONTEYNER 670X260X102 MM	1 ADET

L 659.08 Harris Perineal Ekartör Seti Komple
Harris Perineal Retractor System Complete

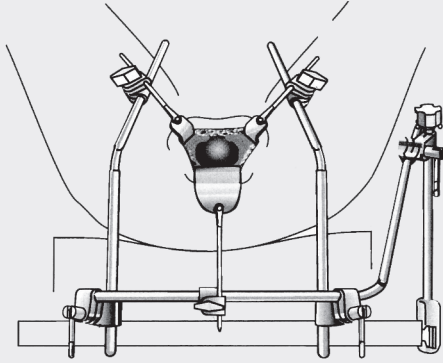

001	L 656.49	HARRİS PROSTAT EKARTÖRÜ	1 ADET
002	L 656.97	MESANE EKARTÖRÜ 75X25 MM	2 ADET
003	L 656.96	MESANE EKARTÖRÜ 65X25 MM	2 ADET
004	L 656.95	MESANE EKARTÖRÜ 75X13 MM	2 ADET
005	L 656.94	MESANE EKARTÖRÜ 70X13 MM	2 ADET
006	L 656.98	MESANE EKARTÖRÜ 65X25 MM	1 ADET
008	L 657.13	MURPHY ÇİLT EKARTÖRÜ KUNT 13X25 MM	1 ADET
009	L 656.02	BUKULEBİLİR EKARTÖR 150X13 MM	1 ADET
010	L 656.12	BUKULEBİLİR EKARTÖR 200X50 MM	1 ADET
011	L 656.09	BUKULEBİLİR EKARTÖR 200X40 MM	1 ADET
012	L 655.10	MASA BAĞLANTI AYAGI TEK BAĞLANTILI 45 CM	1 ADET
013	L 655.27	AÇILI ÇATI MİLİ 20X40 CM	3 ADET
014	L 655.40	ÇATI BAĞLANTI ELEMANI	2 ADET
015	L 655.42	EKARTÖR BAĞLANTI ELEMANI	3 ADET
016	L 655.60	EKARTÖR KOLU SABİT 25 CM	3 ADET
017	Y 885.00	TAŞIMA KONTEYNER 670X260X102 MM	1 ADET

L 659.09 Posterior Lumbar Ekartör Seti Komple
Posterior Lumbar Retractor System Complete

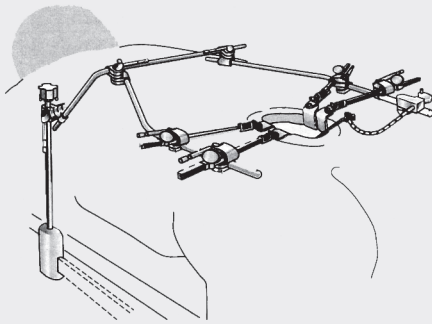

001	L 657.40	ÇİFT AÇILI LAMİNEKTOMİ EKARTÖR 80X20 MM	2 ADET
002	L 657.41	ÇİFT AÇILI LAMİNEKTOMİ EKARTÖR 80X45 MM	2 ADET
003	L 657.42	ÇİFT AÇILI LAMİNEKTOMİ EKARTÖR 80X60 MM	2 ADET
004	L 657.43	ÇİFT AÇILI LAMİNEKTOMİ EKARTÖR 100X20 MM	2 ADET
005	L 657.44	ÇİFT AÇILI LAMİNEKTOMİ EKARTÖR 100X45 MM	2 ADET
006	L 657.45	ÇİFT AÇILI LAMİNEKTOMİ EKARTÖR 100X60 MM	2 ADET
007	L 657.46	ÇİFT AÇILI LAMİNEKTOMİ EKARTÖR 120X20 MM	2 ADET
008	L 657.47	ÇİFT AÇILI LAMİNEKTOMİ EKARTÖR 120X45 MM	2 ADET
009	L 657.48	ÇİFT AÇILI LAMİNEKTOMİ EKARTÖR 120X60 MM	2 ADET
010	L 657.22	MEYERDİNG LAMİNE EKARTÖR DIŞSİZ 100X16 MM	2 ADET
011	L 657.24	MEYERDİNG LAMİNE EKARTÖR DIŞSİZ 75X25 MM	2 ADET
012	L 657.25	MEYERDİNG LAMİNE EKARTÖR DIŞSİZ 100X25 MM	2 ADET
013	L 657.32	MEYERDİNG LAMİNE EKARTÖR DIŞSİZ 100X16 MM	2 ADET
014	L 657.34	MEYERDİNG LAMİNE EKARTÖR DIŞSİZ 75X25 MM	2 ADET
015	L 657.35	MEYERDİNG LAMİNE EKARTÖR DIŞSİZ 100X25 MM	2 ADET
016	L 657.85	ROOT EKARTÖRÜ 90°	1 ADET
017	L 657.86	ROOT EKARTÖRÜ 45°	1 ADET
018	L 655.10	MASA BAĞLANTI AYAGI TEK BAĞLANTILI 45 CM	1 ADET
019	L 655.20	ÇİFT BAĞLANTI ÇATI MİLİ 60 CM	1 ADET
020	L 655.27	AÇILI ÇATI MİLİ 20X40 CM	2 ADET
021	L 655.42	EKARTÖR TUTUCU BAĞLANTI ELEMANI	4 ADET
022	L 655.61	EKARTÖR KOLU AÇISI AYARLANABİLİR 25 CM	4 ADET
023	L 655.68	L 655-61-L 655.64-L 655.67 İCİN AÇI DEGİST.ANAHT.	1 ADET
024	Y 885.00	TAŞIMA KONTEYNER 670X260X102 MM	1 ADET

L 659.10 Spinal Cerrahi Ekartör Seti Komple Spinal Surgery Retarctor System Complete

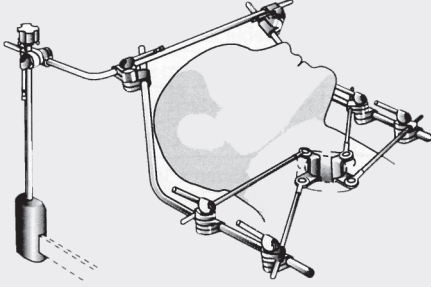

001	L 657.50	SPİNAL EKARTÖR DIŞSİZ 40X16 MM	1 ADET
002	L 657.51	SPİNAL EKARTÖR DIŞSİZ 45X16 MM	1 ADET
003	L 657.52	SPİNAL EKARTÖR DIŞSİZ 50X16 MM	1 ADET
004	L 657.53	SPİNAL EKARTÖR DIŞSİZ 55X16 MM	1 ADET
005	L 657.54	SPİNAL EKARTÖR DIŞSİZ 60X16 MM	1 ADET
006	L 657.55	SPİNAL EKARTÖR DIŞLİ 40X16 MM	1 ADET
007	L 657.56	SPİNAL EKARTÖR DIŞLİ 45X16 MM	1 ADET
008	L 657.57	SPİNAL EKARTÖR DIŞLİ 50X16 MM	2 ADET
009	L 657.58	SPİNAL EKARTÖR DIŞLİ 55X16 MM	2 ADET
010	L 657.59	SPİNAL EKARTÖR DIŞLİ 60X16 MM	2 ADET
011	L 657.70	EKARTÖR EĞRİ UÇLU 55X20 MM	2 ADET
012	L 657.71	EKARTÖR EĞRİ UÇLU 30X25 MM	2 ADET
013	L 657.72	EKARTÖR EĞRİ UÇLU 40X25 MM	2 ADET
014	L 657.74	EKARTÖR EĞRİ UÇLU 60X25 MM	2 ADET
015	L 657.76	EKARTÖR EĞRİ UÇLU 80X25 MM	2 ADET
016	L 655.10	MASA BAĞLANTI AYAĞI TEK BAĞLANTILI 45 CM	1 ADET
017	L 655.20	ÇİFT BAĞLANTI ÇATI MİLİ 60 CM	1 ADET
018	L 655.28	AÇILI ÇATI MİLİ 20X30 CM	2 ADET
019	L 655.42	EKARTÖR TUTUCU BAĞLANTI ELEMANI	4 ADET
020	L 655.60	EKARTÖR KOLU SABİT 25 CM	4 ADET
021	Y 885.00	TAŞIMA KONTEYNER 670X260X102 MM	1 ADET

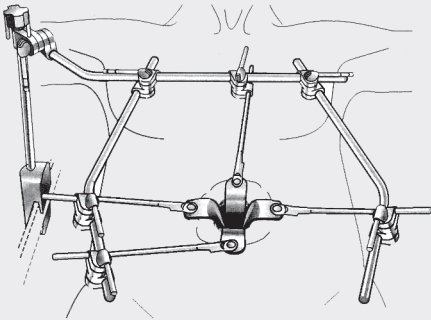

L 659.11 Anterior Lumbar Ekartör Seti Komple Anterior Lumbar Retractor System Complete

001	L 656.28	DAMAR EKARTÖRÜ BÜKÜLEBİLİR 140X25 MM	2 ADET
002	L 656.29	DAMAR EKARTÖRÜ BÜKÜLEBİLİR 200X25 MM	2 ADET
003	L 656.25	DAMAR EKARTÖRÜ BÜKÜLEBİLİR 140X25 MM	2 ADET
004	L 656.26	DAMAR EKARTÖRÜ BÜKÜLEBİLİR 200X25 MM	2 ADET
005	L 657.90	ANTERIOR LUMBAR EKARTÖR TIRNAKLI 100X25 MM	2 ADET
006	L 657.91	ANTERIOR LUMBAR EKARTÖR TIRNAKLI 150X25 MM	2 ADET
007	L 657.92	ANTERIOR LUMBAR EKARTÖR TIRNAKLI 200X25 MM	2 ADET
008	L 657.94	ANTERIOR LUMBAR EKARTÖR TIRNAKLI 100X30 MM	2 ADET
009	L 657.95	ANTERIOR LUMBAR EKARTÖR TIRNAKLI 150X30 MM	2 ADET
010	L 657.96	ANTERIOR LUMBAR EKARTÖR TIRNAKLI 200X30 MM	2 ADET
011	L 657.97	ANTERIOR LUMBAR EKARTÖR TIRNAKLI 250X30 MM	2 ADET
012	L 657.93	ANTERIOR LUMBAR EKARTÖR TIRNAKLI 250X25 MM	2 ADET
013	L 655.10	MASA BAĞLANTI AYAĞI TEK BAĞLANTILI 45 CM	1 ADET
014	L 655.20	ÇİFT BAĞLANTI ÇATI MİLİ 60 CM	1 ADET
015	L 655.27	AÇILI ÇATI MİLİ 20X40 CM	2 ADET
016	L 655.42	EKARTÖR TUTUCU BAĞLANTI ELEMANI	4 ADET
017	L 655.60	EKARTÖR KOLU SABİT 25 CM T	4 ADET
018	Y 885.00	TAŞIMA KONTEYNER 670X260X102 MM	1 ADET

Urun Kodu	Sayfa	Urun Kodu	Sayfa	Urun Kodu	Sayfa	Urun Kodu	Sayfa
L 655.10	2	L 656.23	4	L 656.81	5	L 657.58	7
L 655.12	2	L 656.24	4	L 656.83	5	L 657.59	7
L 655.15	2	L 656.25	4	L 656.84	5	L 657.60	7
L 655.17	2	L 656.26	4	L 656.90	6	L 657.61	7
L 655.20	2	L 656.28	4	L 656.91	6	L 657.62	7
L 655.21	2	L 656.29	4	L 656.94	6	L 657.63	7
L 655.25	2	L 656.30	5	L 656.95	6	L 657.64	7
L 655.26	2	L 656.31	5	L 656.96	6	L 657.65	7
L 655.27	2	L 656.32	5	L 656.97	6	L 657.66	7
L 655.28	2	L 656.33	5	L 656.98	6	L 657.67	7
L 655.29	2	L 656.34	5	L 657.00	6	L 657.68	7
L 655.30	2	L 656.35	5	L 657.01	6	L 657.70	7
L 655.31	2	L 656.36	5	L 657.02	6	L 657.71	7
L 655.32	2	L 656.37	5	L 657.03	6	L 657.72	7
L 655.33	2	L 656.38	5	L 657.10	6	L 657.73	7
L 655.34	2	L 656.39	5	L 657.11	6	L 657.74	7
L 655.40	3	L 656.40	4	L 657.12	6	L 657.75	7
L 655.42	3	L 656.41	4	L 657.13	6	L 657.76	7
L 655.50	3	L 656.42	4	L 657.20	7	L 657.80	7
L 655.55	3	L 656.43	4	L 657.21	7	L 657.81	7
L 655.60	3	L 656.44	4	L 657.22	7	L 657.85	7
L 655.61	3	L 656.45	4	L 657.23	7	L 657.86	7
L 655.63	3	L 656.46	6	L 657.24	7	L 657.90	7
L 655.64	3	L 656.47	6	L 657.25	7	L 657.91	7
L 655.66	3	L 656.49	6	L 657.30	7	L 657.92	7
L 655.67	3	L 656.50	5	L 657.31	7	L 657.93	7
L 655.68	3	L 656.51	5	L 657.32	7	L 657.94	7
L 656.00	4	L 656.52	5	L 657.33	7	L 657.95	7
L 656.01	4	L 656.53	5	L 657.34	7	L 657.96	7
L 656.02	4	L 656.54	5	L 657.35	7	L 659.00	8
L 656.03	4	L 656.55	5	L 657.40	7	L 659.01	8
L 656.04	4	L 656.60	5	L 657.41	7	L 659.02	9
L 656.05	4	L 656.61	5	L 657.42	7	L 659.03	9
L 656.06	4	L 656.62	5	L 657.43	7	L 659.04	10
L 656.07	4	L 656.63	5	L 657.44	7	L 659.05	10
L 656.08	4	L 656.67	5	L 657.45	7	L 659.06	11
L 656.09	4	L 656.68	5	L 657.46	7	L 659.07	11
L 656.10	4	L 656.70	5	L 657.47	7	L 659.08	12
L 656.11	4	L 656.71	5	L 657.48	7	L 659.09	12
L 656.12	4	L 656.72	5	L 657.50	7	L 659.10	13
L 656.13	4	L 656.73	5	L 657.51	7	L 659.11	13
L 656.14	4	L 656.75	5	L 657.52	7	Y 885.00	8-9-10-11
L 656.15	4	L 656.76	5	L 657.53	7		12-13
L 656.16	4	L 656.77	5	L 657.54	7		
L 656.20	4	L 656.78	5	L 657.55	7		
L 656.21	4	L 656.79	5	L 657.56	7		
L 656.22	4	L 656.80	5	L 657.57	7		



BAHADIR A.Ş.
Organize Sanayi Bölgesi
55300 SAMSUN
Tel: +90 362 266 70 00
Fax: +90 362 266 70 05

www.bahadir.com.tr
info@bahadir.com.tr
Location 41.2389, 36.4277



UNIVERSAL EKARTOR/03/04/0612