

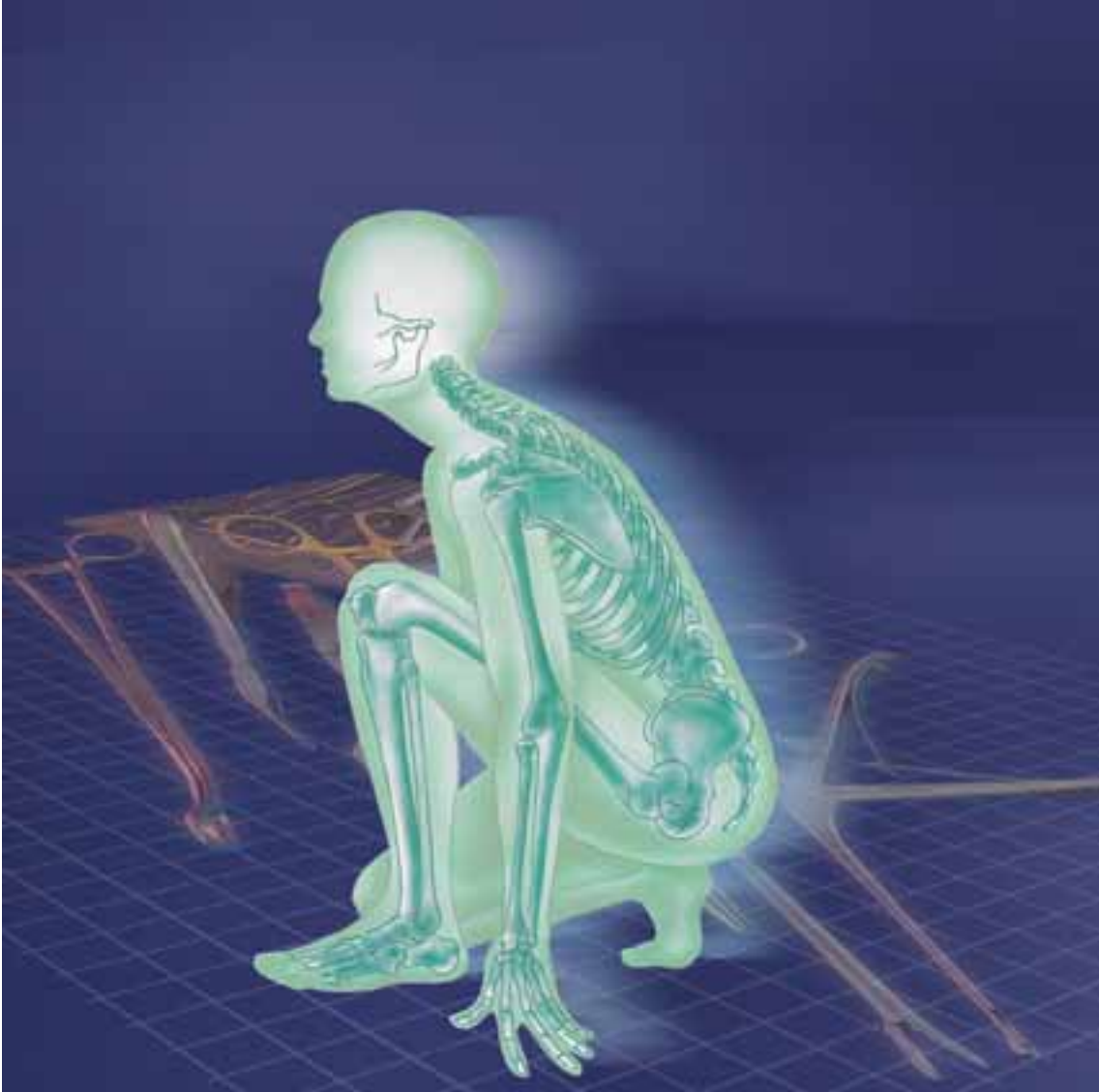

**ORTOPEDİ, KEMİK CERRAHİ,
EL CERRAHİ, ATROSKOPİK CERRAHİ**

**ORTHOPEDIC INSTRUMENTS, BONE SURGERY,
HAND SURGERY, ARTHROSCOPIC INSTRUMENTS**





**ORTOPEDİ, KEMİK CERRAHİ,
EL CERRAHİ, ATROSKOPİK CERRAHİ**

**ORTHOPEDIC INSTRUMENTS, BONE SURGERY,
HAND SURGERY, ARTHROSCOPIC INSTRUMENTS**

**BAHADIR TIBBİ ALETLER SANAYİ VE TİCARET A.Ş.
BAHADIR MEDICAL EQUIPMENT INDUSTRY AND TRADE CO.**
Organize Sanayi 55 300 / KUTLUKENT / SAMSUN / TURKEY
Tel : 90 (362) 266 70 01 (Pbx) Fax : 90 (362) 266 70 05
www.bahadir.com.tr E-mail : info@bahadir.com.tr



BAHADIR Tıbbi Aletler 1983 yılında Samsun 'da kurulmuştur. Üretim kalitesinin yüksekliği, satış ve servis organizasyonu ile bu alanda lider olarak tanınmaktadır.

Kataloğumuzda yer alan ürünlerimiz, ham malzemeden son ürün haline gelinceye kadar bilgi, beceri, deneyimlerimiz ve yüksek teknolojiyle desteklenerek titiz bir kalite denetim sistemi içerisinde üretilmiştir. Aksi belirtilmedikçe kataloğumuzda yer alan ürünlerimiz, uygun spesifikteki paslanmaz çelikten üretilmiş, çizimler ve resimler gerçek boyutlarında verilmiştir.

Geçtiğimiz yıllar boyunca tıp camiasından gördüğümüz yakın ilgi, güven ve destek sayesinde bugün cerrahi branşların hemen hepsi için alet üretiyoruz. Ürünlerimiz uluslararası pazarlarda haklı bir üne kavuşmuştur.

Ortopedi cerrahi üretim programımızı içeren bu kataloğumuz ile birlikte K.B.B. ve Plastik Cerrahi, Endoskopi, Steril Konteyner Sistemleri kataloglarımız ve cerrahi branşlara göre hazırlanmış kataloglarımız mevcuttur. Kataloglarımız gelişen tıbbi teknikler ve yaklaşımlar ile ortaya çıkan yeni dizayn alet ve setleri de kapsayacak şekilde titiz bir çalışma ile hazırlanmıştır.

Sizlere sunacaklarımız bu kataloglarla sınırlı değildir. Alet ve setlerinizin bakım ve onarımı, mevcut dizaynlar üzerinde değişiklik istekleriniz, yeni cerrahi teknikler için geliştireceğiniz aletlerin üretimi ve bu katalogta yer almayan diğer ürünler için teknik olanaklarımız, bilgi ve deneyimlerimiz daima emrinizde olacaktır.

Tıp camiasına ve bu katalogun hazırlanmasında emeği geçenlere öneri ve eleştirileri ile bizleri yönlendirenlere teşekkür ederiz.



Being established in 1983 in Samsun / Turkey, BAHADIR Medical Equipment has been recognized as a leader in the production of Surgical Instruments for its exceptional quality products, sales and wide range of service organization.

All instruments pictured in this catalog are the products of consistent craftsmanship combined with advanced production techniques and traditional skills acquired over the years. Forging to crafting-utmost care has been taken to ensure accuracy in every stage of production and our strive continues to achieve highest standards and top quality products. Instruments displayed here are stainless steel and they are shown in full scale unless otherwise indicated.

BAHADIR enjoys a significant reputation of manufacturing instruments for all surgical branches, thanks to close cooperation and support from our medical society which made them competitive international markets.

In addition to this catalog, we also have supplemental catalogues for ENT, Edoscopy and Steril Container System available on request. We are, however, conscious of the fact that this catalog remains insufficient to cover all the facilities and novelties we can offer. It is our endeavor to develop new products as new technology and demands for new procedures become known.

We will always be at your disposal with our technical facilities knowledge and vast experience for your specific needs including refurbishment of your instruments and sets, modification of present patterns, custom-made production on entirely new designs developed to your surgical techniques as well as any other product which is not displayed here.

BAHADIR would like to thank all those co-operated in the compilation of this catalog.





GARANTİ / GUARANTEE

BAHADIR tescilli markasını ve logosunu taşıyan ürünler malzeme ve işçilik açısından beş yıl garantilidir. Bu süre içinde normal kullanım koşullarında arızalanan aletler ücretsiz olarak onarılacak yada yenisi ile değiştirilecektir.

All products carrying the registered trademark and logo of BAHADIR are guaranteed for five years in respect of material and workmanship in normal use. We will replace or repair any damaged instrument free of charge during this period.

Her hakkı saklıdır.

Bu kataloğun hiçbir bölümü BAHADIR'ın yazılı izni olmadan kopya edilemez, yayınlanamaz.

All rights reserved.

No part of this catalog may be reproduced in any form without written permission from BAHADIR.

**Aletler
Instruments**

**Sayfa
Page**

1-242



**Steril Konteyner Sistemleri
Steril Container Systems**

**Sayfa
Page**

243-266



**Setler
Sets**

**Sayfa
Page**

267-284



**Numerical İndeks
Numerical Index**

**Sayfa
Page**

285-300





INSTRUMENTS





3 No



B 030.00
13.5 cm



B 030.01
13.5 cm



B 030.02
21.5 cm



B 034.00
22.5 cm



B 034.01
22.5 cm

4 No



1/1

B 040.00
13.5 cm



1/1

B 040.01
13.5 cm



1/1

B 045.00
15 cm



1/1

B 040.02
21.5 cm



1/1

B 043.00
22.5 cm



1/1

B 043.01
22.5 cm



1/2
REHN
B 180.00
23.5 cm



1/2
SCHINIC
B 182.00
30 cm



B 188.00

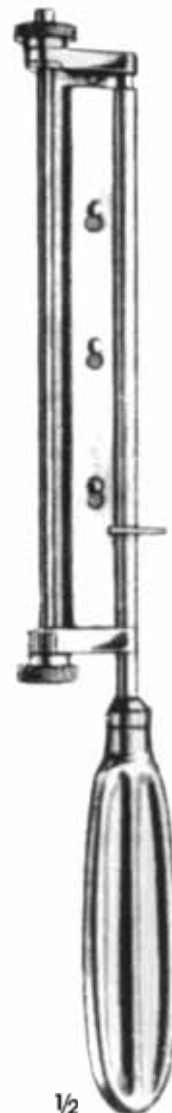

1/2
WATSON
B 184.00
30 cm



1/2
SILVER
B 186.00
19 cm



C 102.00

C 103.00

C 102.00 - C 103.00
12 cm

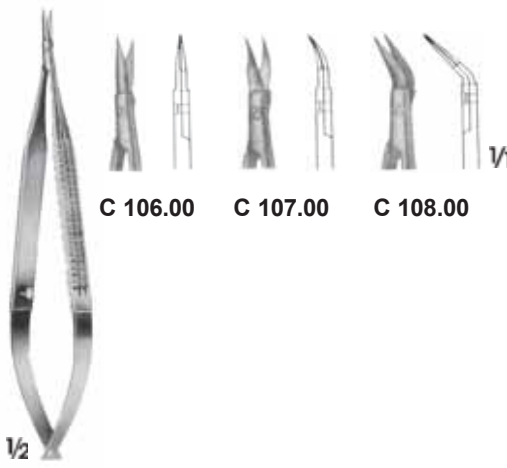

C 106.00

C 107.00

C 108.00

VANNAS
C 106.00 - C 108.00
12 cm

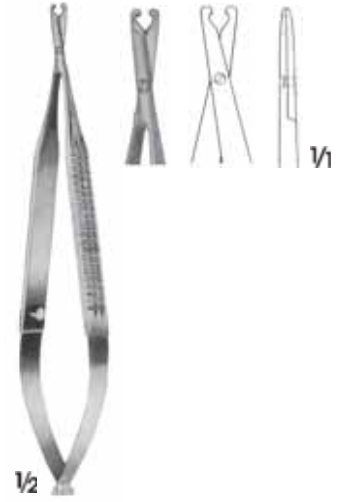

1/2

BIEMER
C 110.00
13 cm

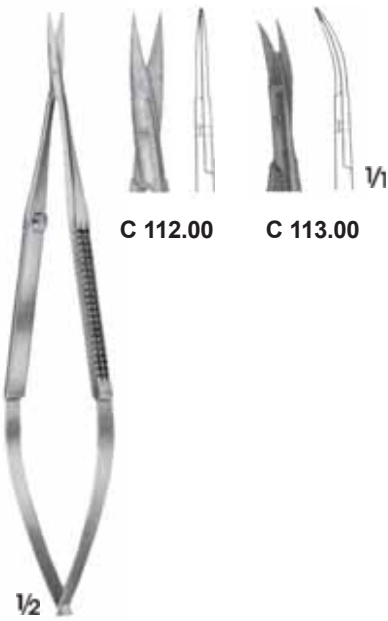

C 112.00

C 113.00

C 112.00 - C 113.00
16cm

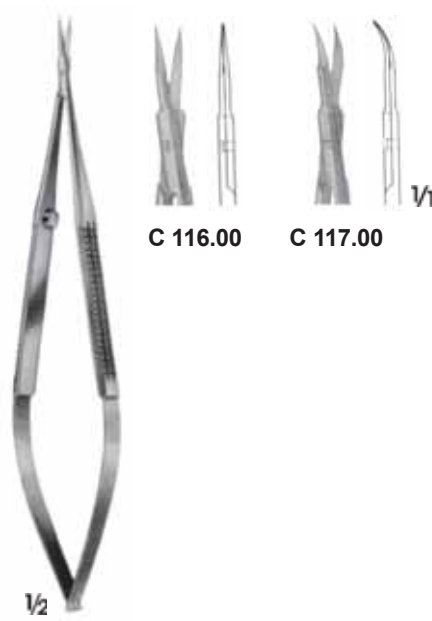

C 116.00

C 117.00

VANNAS
C 116.00 - C 117.00
16cm

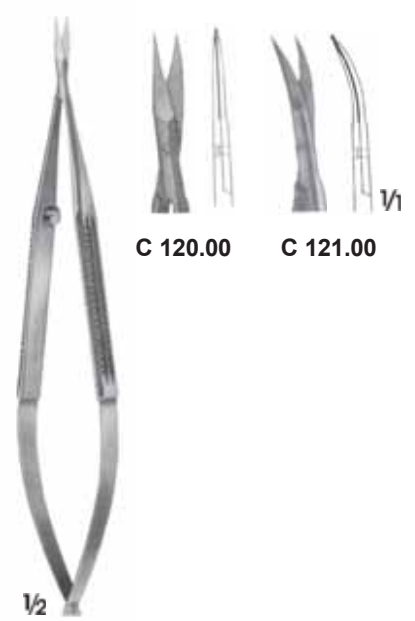

C 120.00

C 121.00

VANNAS
C 120.00 - C 121.00
Çift ağızlı tırtıllı
Both jaws serrated
16 cm

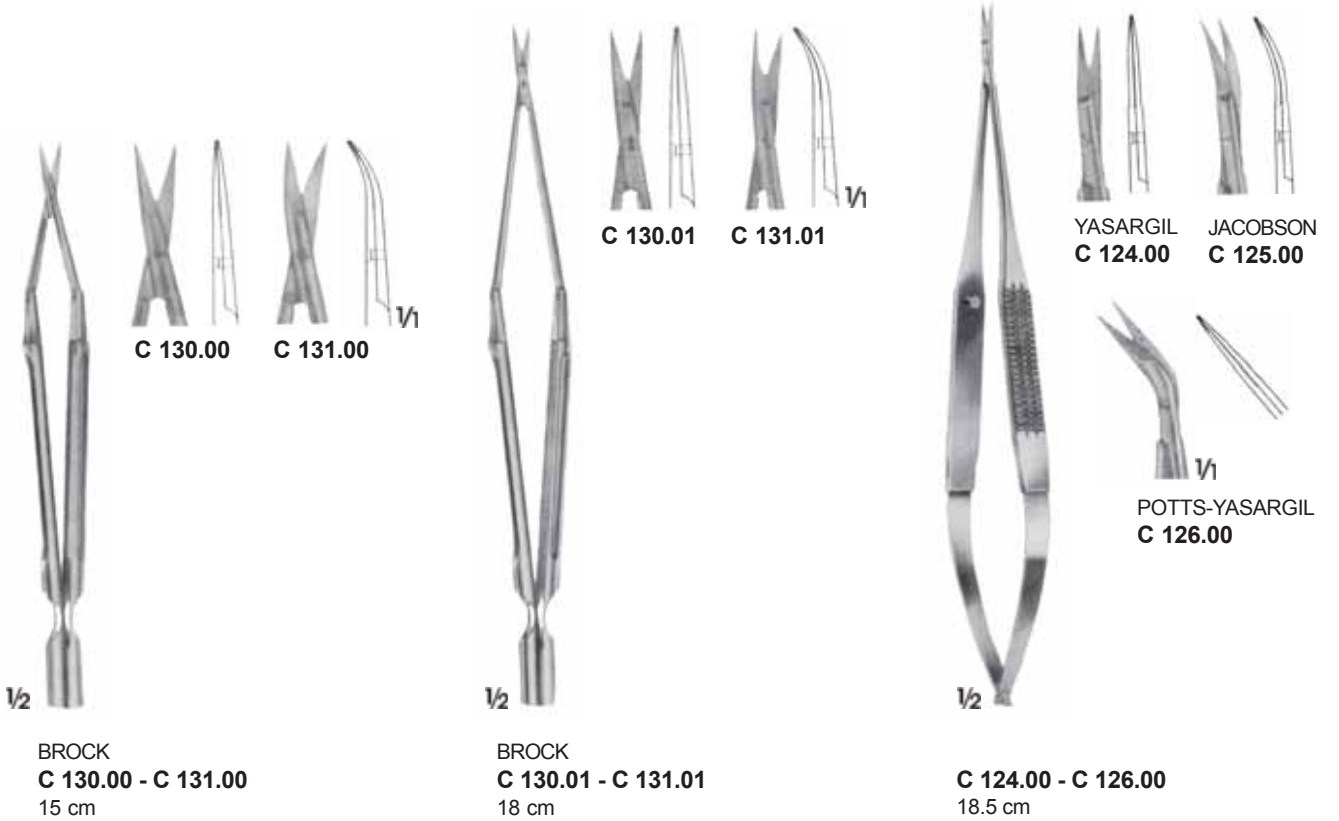
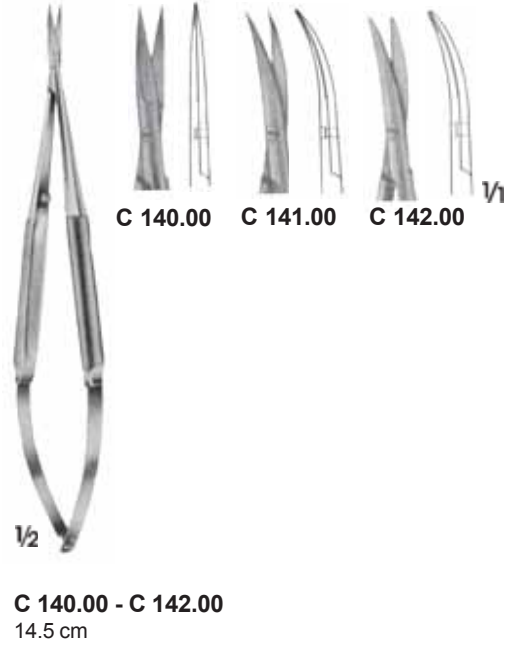
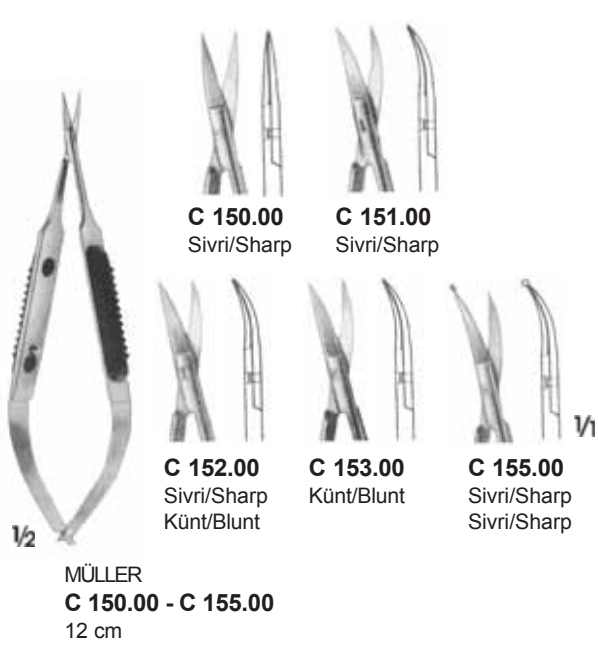



C 220.00
Düz / Straight



C 221.00
Eğri / Curved



C 222.00
Düz / Straight



C 223.00
Eğri / Curved

C 220.00 - C 221.00
9 cm

C 222.00 - C 223.00
9.5 cm



C 230.00
Sivri/Sharp



C 231.00
Sivri/Sharp



C 232.00
Sivri/Sharp
Künt/Blunt



C 233.00
Sivri/Sharp
Künt/Blunt



C 234.00
Sivri/Sharp
Künt/Blunt

C 230.00 - C 234.00
11 cm





C 310.00 10.5 cm **C 310.01** 11.5 cm **C 310.02** 13 cm **C 310.03** 14.5 cm **C 310.04** 15 cm **C 310.05** 16.5 cm **C 310.06** 17.5 cm **C 310.07** 18.5 cm **C 310.08** 20 cm

C 310.00-C 310.08



C 311.01 11.5 cm **C 311.02** 13 cm **C 311.03** 14.5 cm **C 311.04** 15 cm **C 311.05** 16.5 cm **C 311.06** 17.5 cm **C 311.07** 18.5 cm

C 311.01-C 311.07

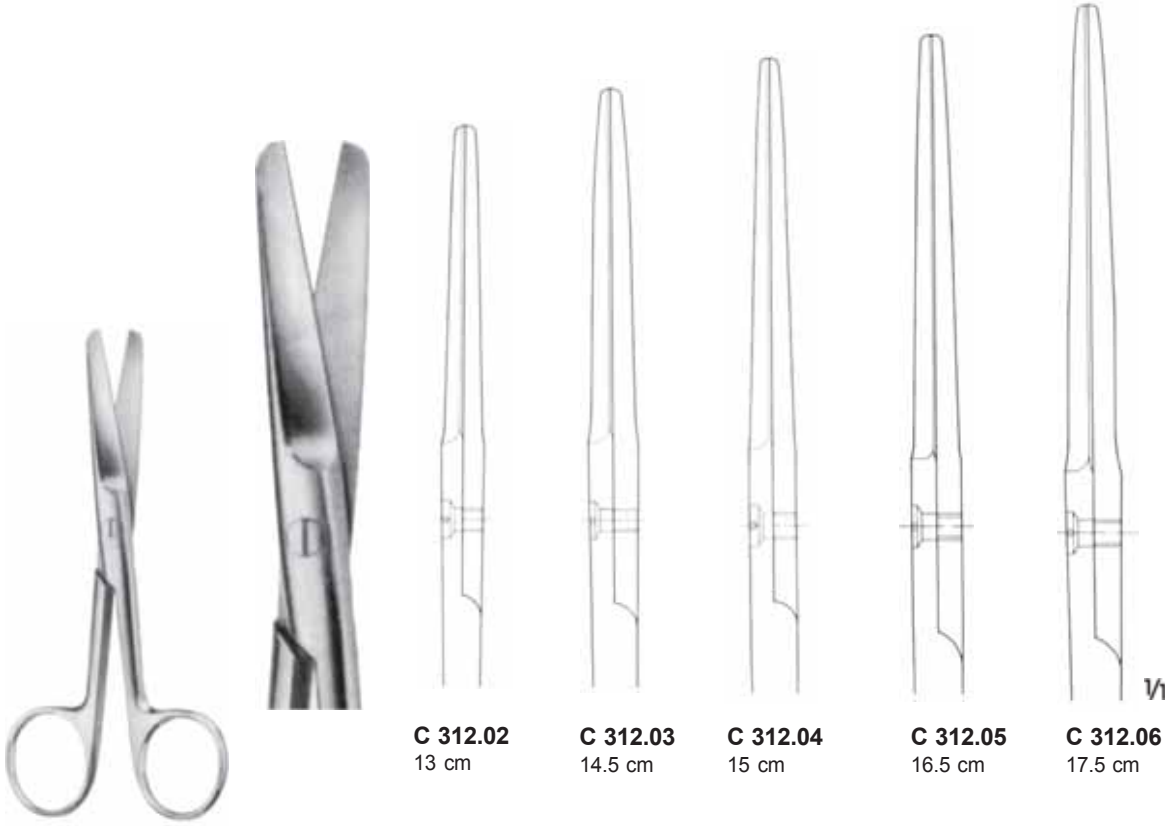

C 312.02 - C 312.06
Künt/Blunt
Düz/ Straight

C 312.02
13 cm

C 312.03
14.5 cm

C 312.04
15 cm

C 312.05
16.5 cm

C 312.06
17.5 cm

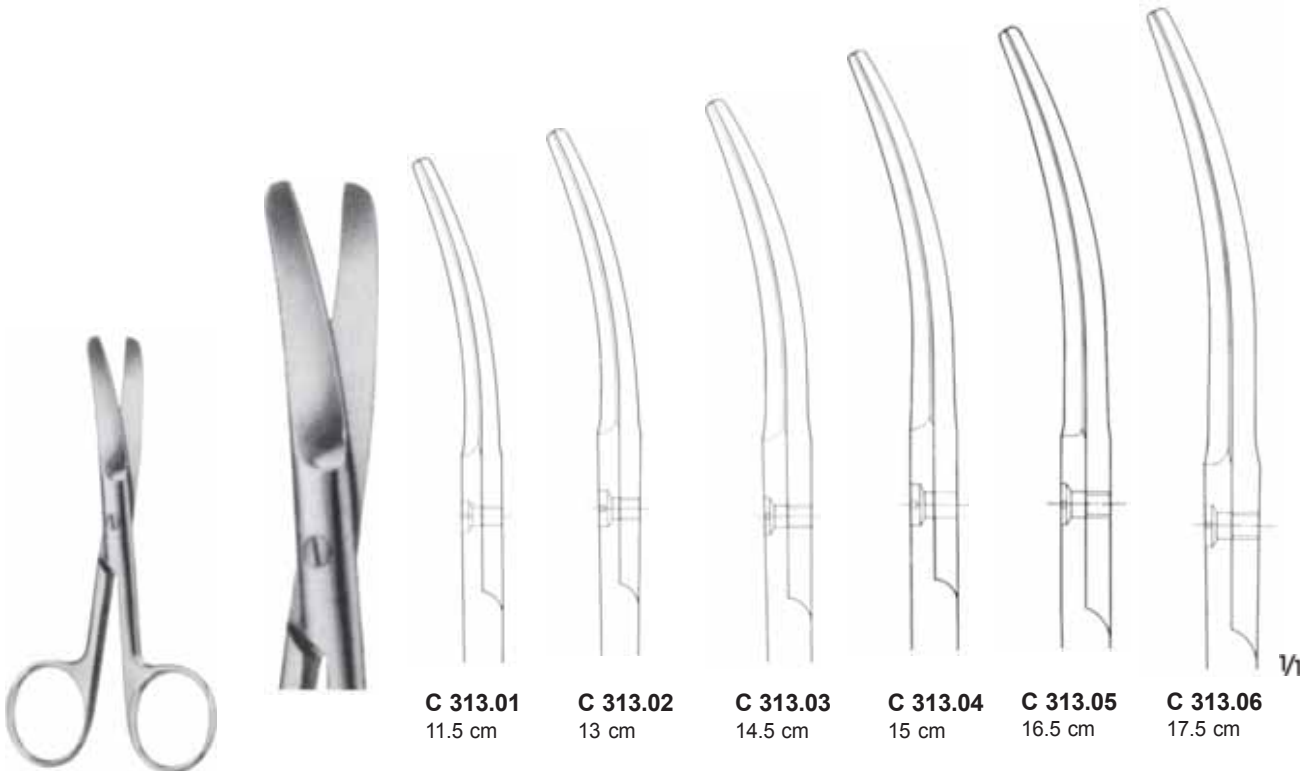

C 313.01 - C 313.06
Künt/Blunt
Eğri/ Curvet

C 313.01
11.5 cm

C 313.02
13 cm

C 313.03
14.5 cm

C 313.04
15 cm

C 313.05
16.5 cm

C 313.06
17.5 cm



C 314.01 - C 314.05
Sivri/Sharp
Düz/Straight



C 314.01
11.5 cm



C 314.02
13 cm



C 314.03
14.5 cm



C 314.04
15 cm



C 314.05
16,5 cm

1/1



C 315.01- C 315.04
Sivri/Sharp
Eğri/Curved



C 315.01
11.5 cm



C 315.02
13 cm



C 315.03
14.5 cm



C 315.04
15 cm

1/1





1/1

C 420.00
 Düz/Straight
 14.5 cm

C 420.01
 Düz/Straight
 18 cm

C 420.02
 Düz/Straight
 20 cm

C 421.00
 Eğri/Curved
 14.5 cm

C 421.01
 Eğri/Curved
 18 cm

C 421.02
 Eğri/Curved
 20 cm

 METZENBAUM
C 420.00 - C 421.02

1/1

C 440.00
 Düz/Straight
 14 cm

C 440.01
 Düz/Straight
 15.5 cm

C 440.02
 Düz/Straight
 17 cm

C 441.00
 Eğri/Curved
 14 cm

C 441.01
 Eğri/Curved
 15.5 cm

C 441.02
 Eğri/Curved
 17 cm

 MAYO
C 440.00- C 441.02

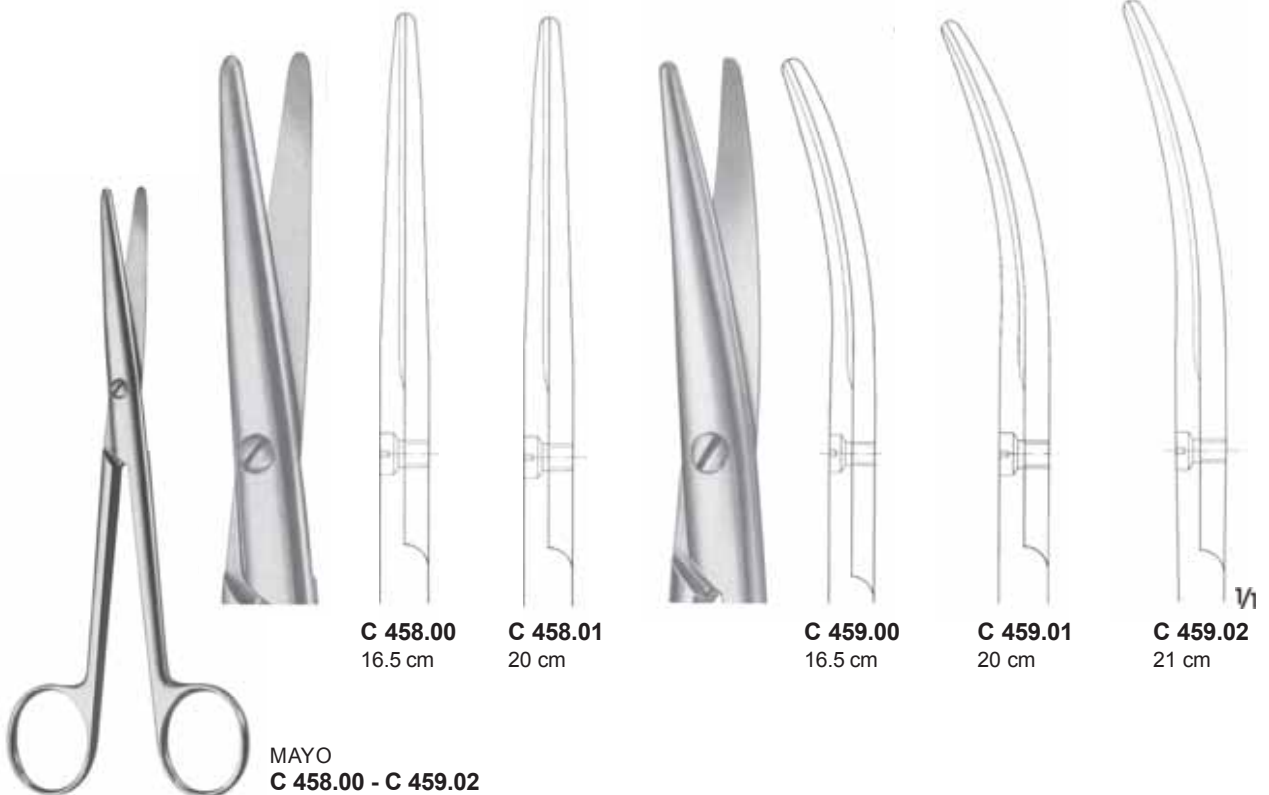
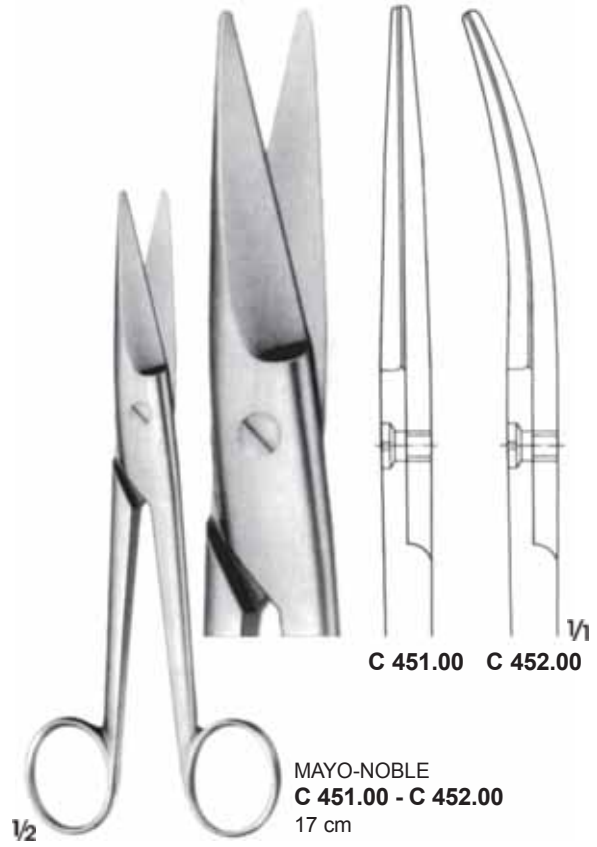



C 630.00
Tek ağız tırtıllı
One jaw serrated
16 cm

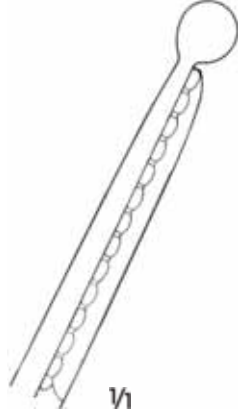

C 631.00
Tek ağız tırtıllı
One jaw serrated
20.5 cm



BRAUN-STADLER
C 632.00
22.5 cm



SEUTIN
C 633.00
Tek ağız tırtıllı
One jaw serrated
23 cm



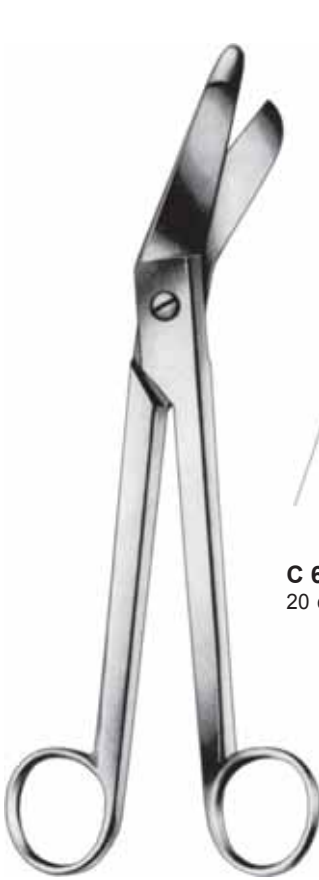

C 653.00
20 cm

ESMARCH
C 653.00 - C 653.01
Tek ağız tırtıllı
One jaw serrated



C 653.01
23 cm



BERGMANN
C 654.00
Tek ağız tırtıllı
One jaw serrated
23 cm



BRUNS
C 656.00
23.5 cm



C 658.00
Tek ağız tırtıllı
One jaw serrated
23.5 cm

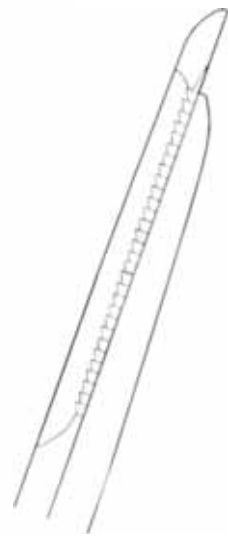



D 103.00
11 cm



D 103.01
11 cm



D 104.00
11 cm



D 105.00
11.5 cm



D 106.00
1 X 2 Diş
1 x 2 Teeth
11.5 cm



D 108.00
13.5 cm

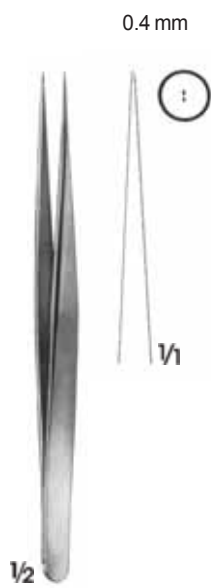

D 109.00
1 x 2 diş/1 x 2 Teeth
13.5 cm



WISE
D 110.00
13.5 cm



WISE
D 113.00
13.5 cm

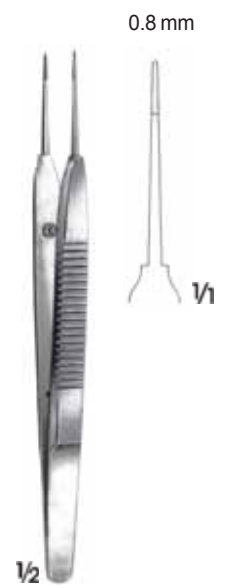

AUSTIN
D 125.00
14 cm

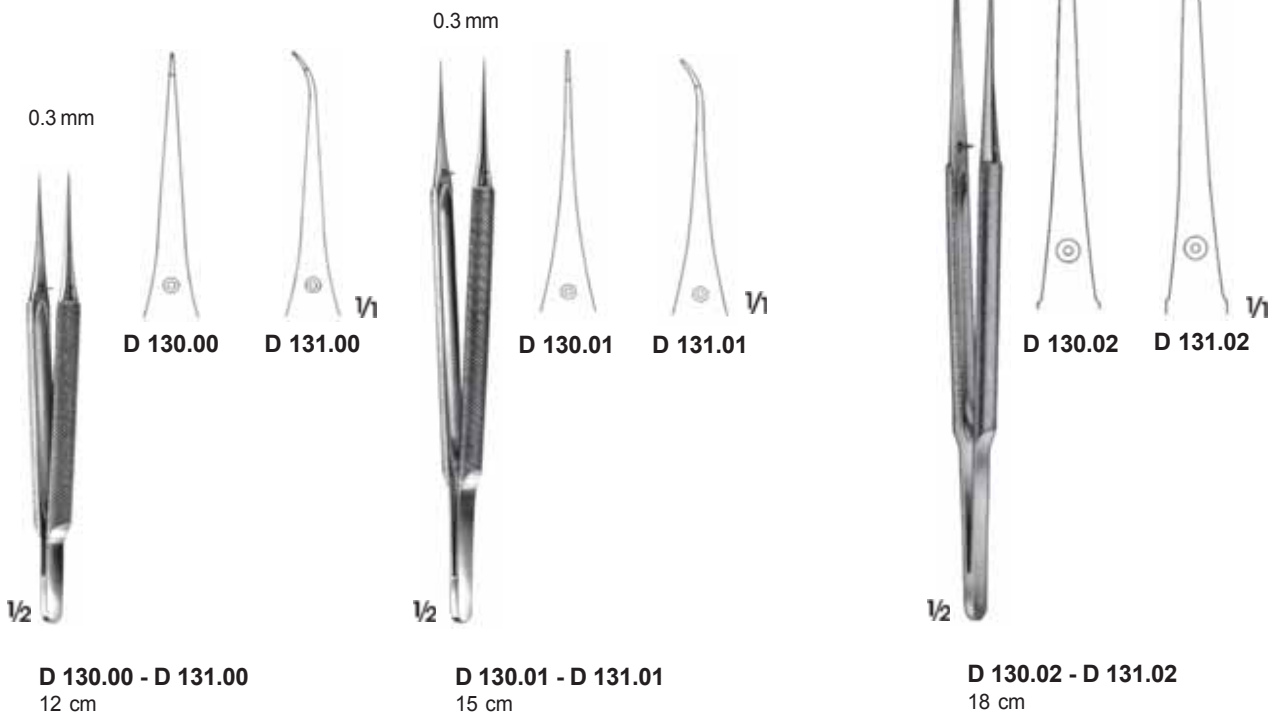
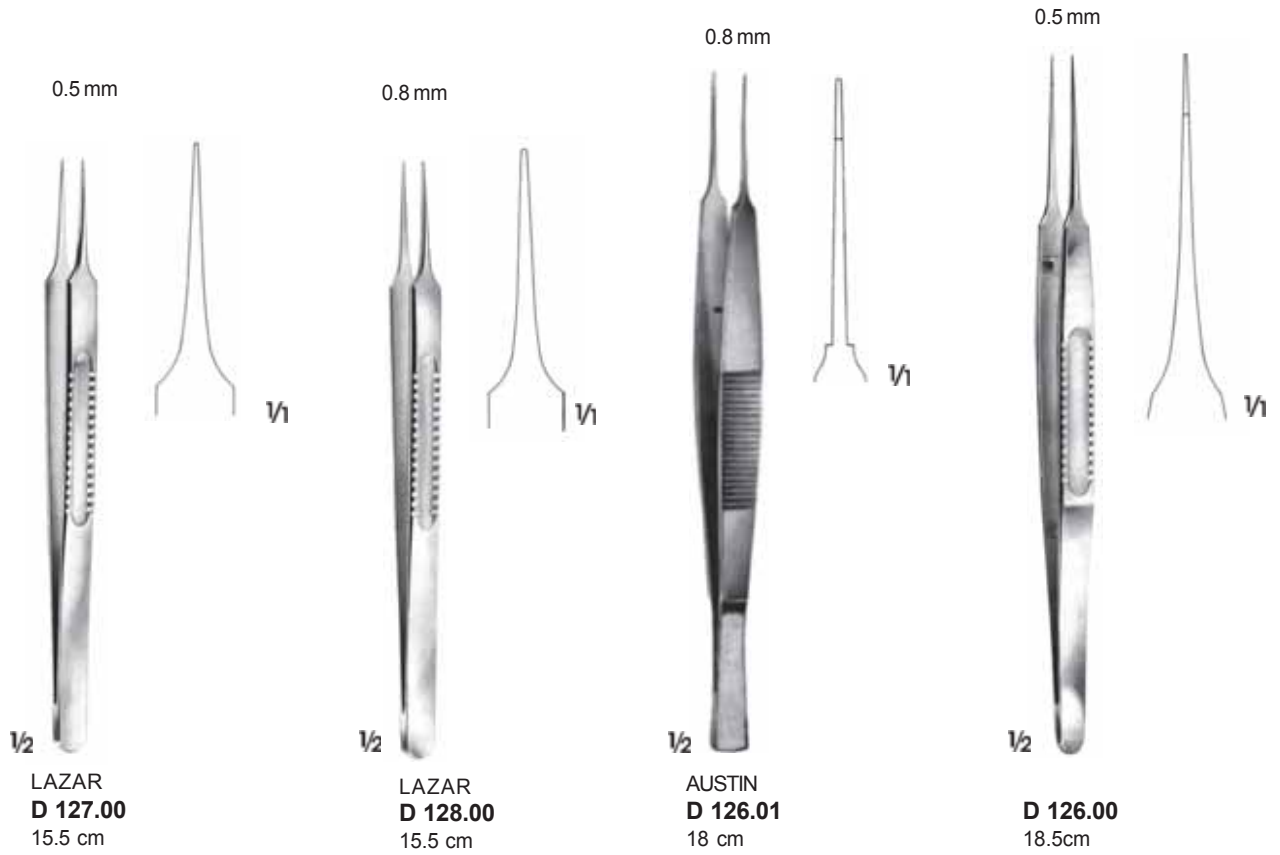



MICRO-ADSON
D 204.00
 12 cm



ADSON
D 205.00
 12 cm

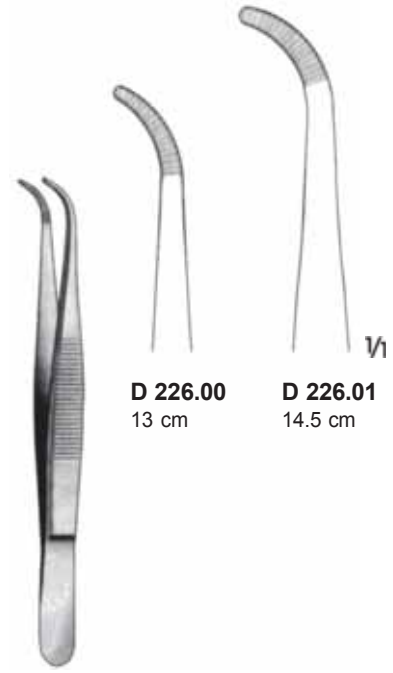

D 226.00
 13 cm

D 226.01
 14.5 cm

D 226.00-D 226.01

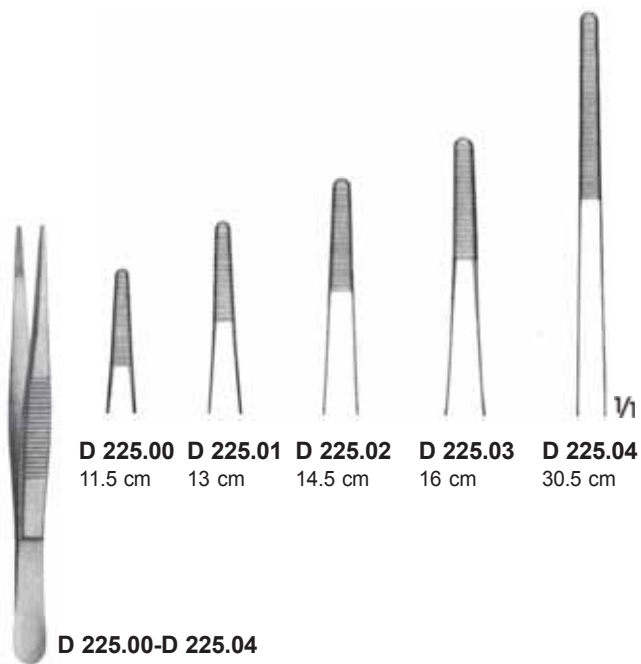

D 225.00
 11.5 cm

D 225.01
 13 cm

D 225.02
 14.5 cm

D 225.03
 16 cm

D 225.04
 30.5 cm

D 225.00-D 225.04

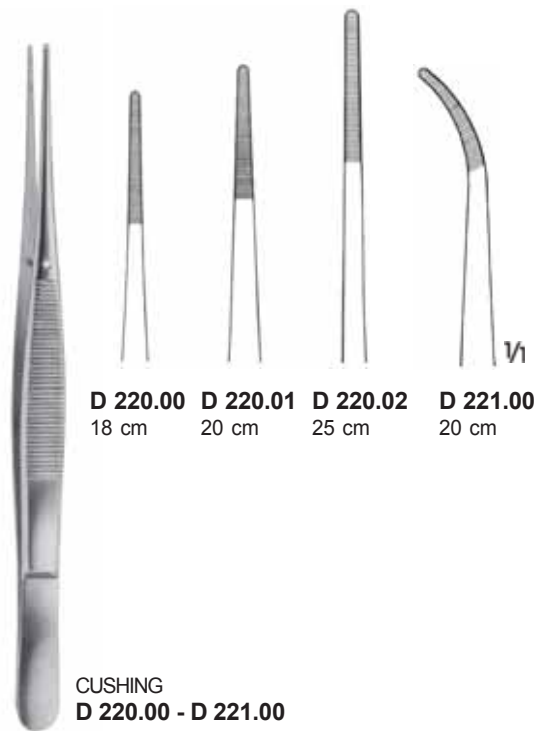

D 220.00
 18 cm

D 220.01
 20 cm

D 220.02
 25 cm

D 221.00
 20 cm

CUSHING
D 220.00 - D 221.00

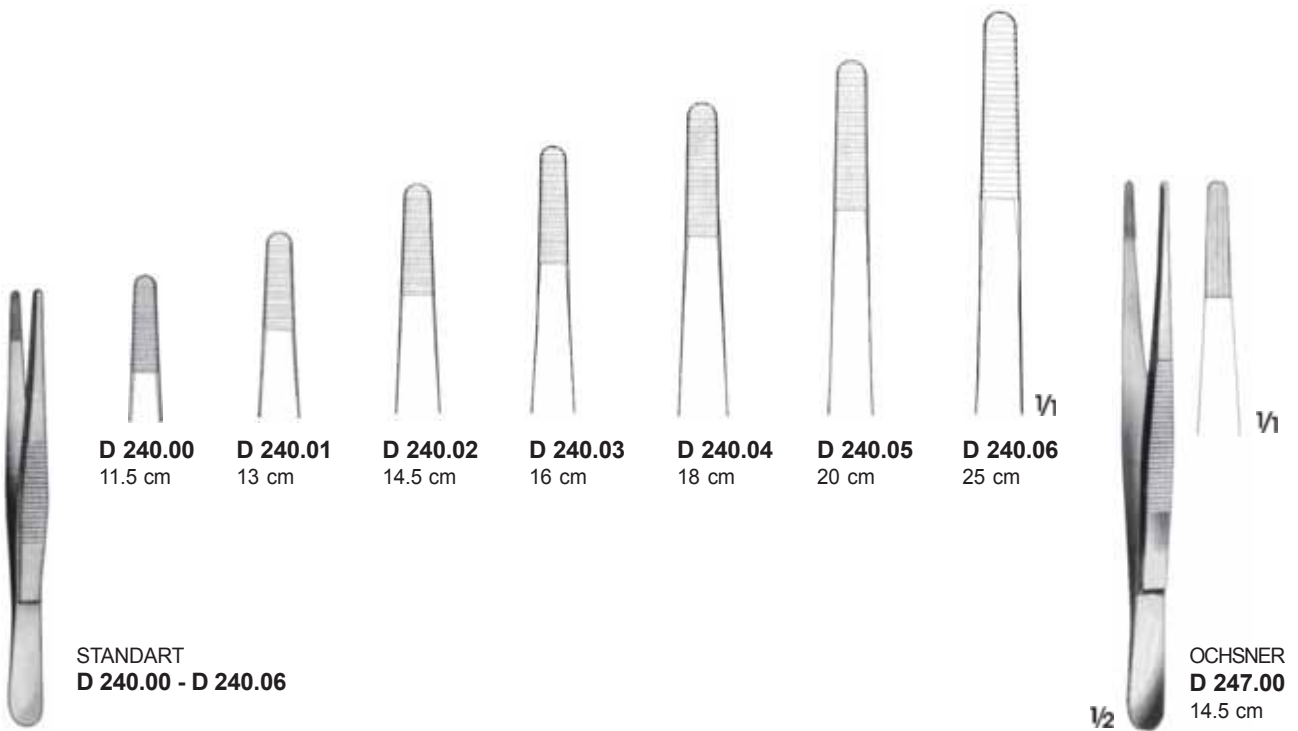
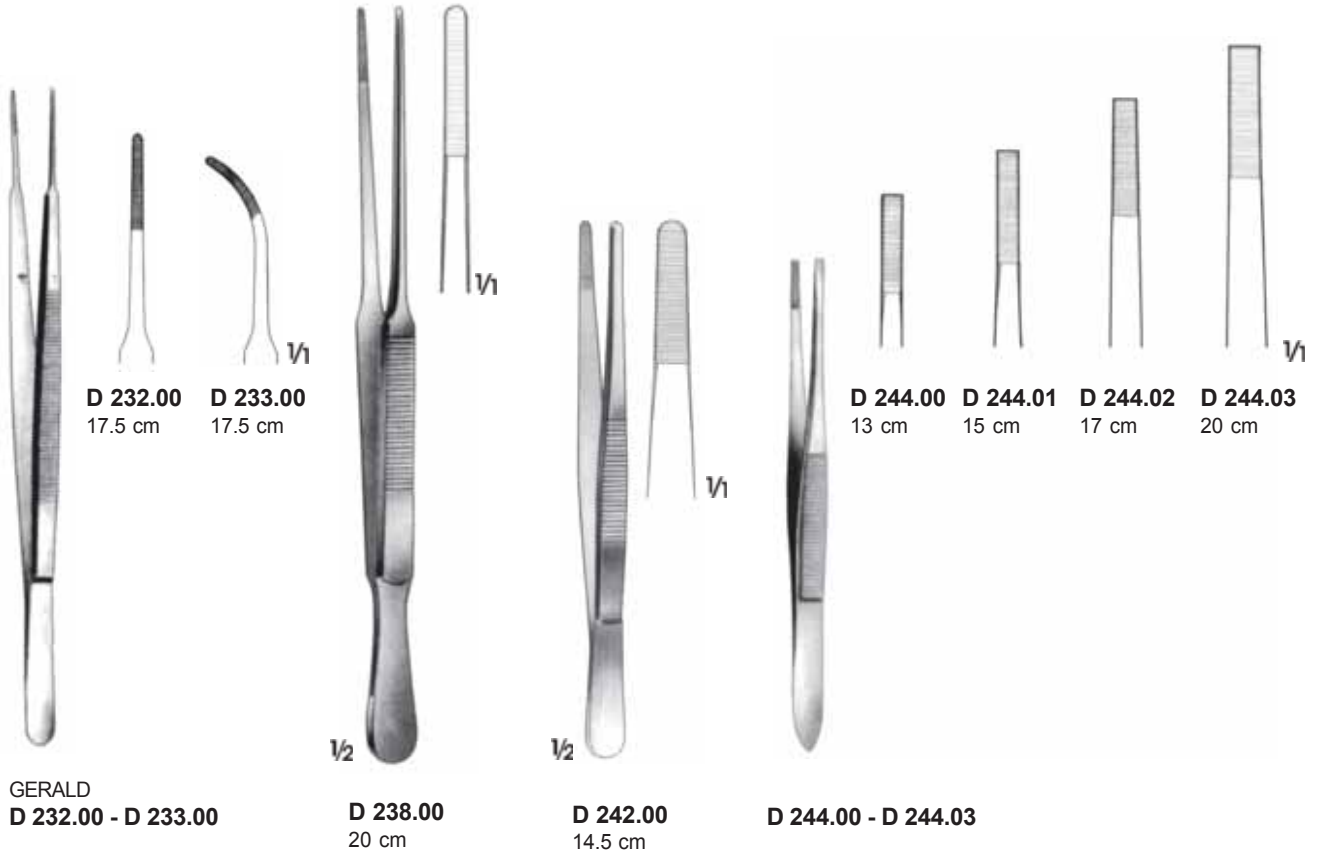

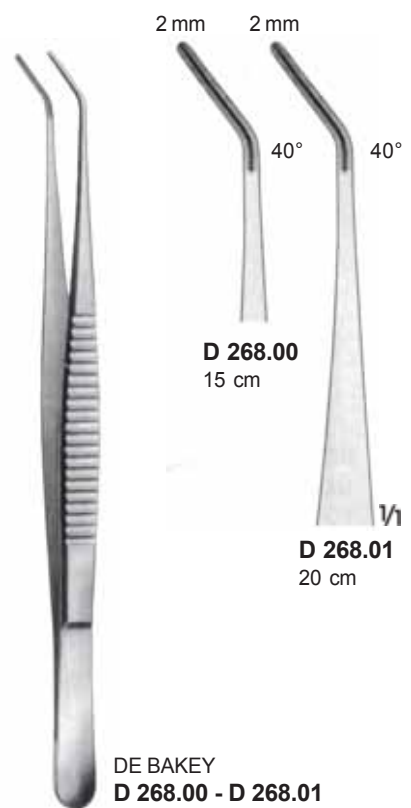
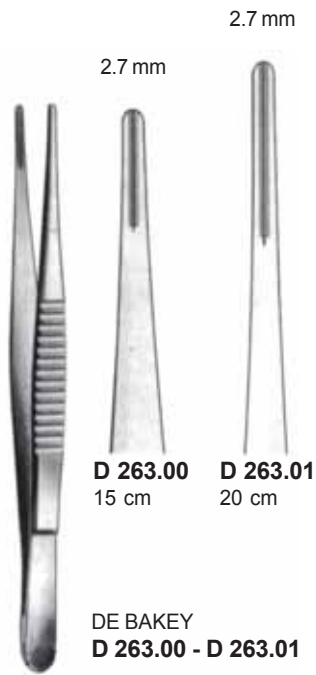
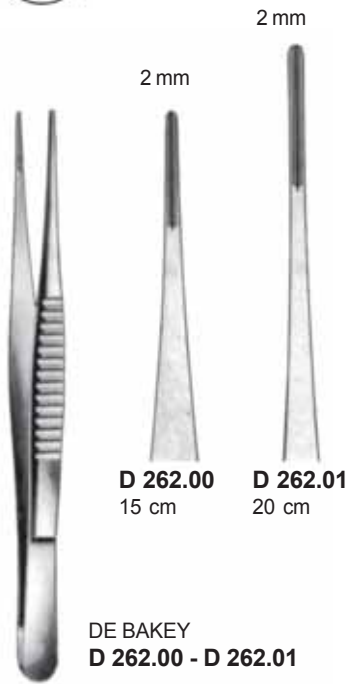



MICRO-ADSON-BIEMER
D 320.00
 12 cm



MICRO-ADSON
D 322.00
 12 cm



ADSON
D 323.00
 12 cm



ADSON
D 324.00
 12 cm



ADSON
D 325.01
 12 cm



MICRO-ADSON
D 327.00
 15 cm



ADSON
D 329.00
 15 cm



ADSON-BROWN
D 340.00
 12 cm



BROWN
D 341.00 15 cm
D 341.01 20 cm
D 341.02 25 cm

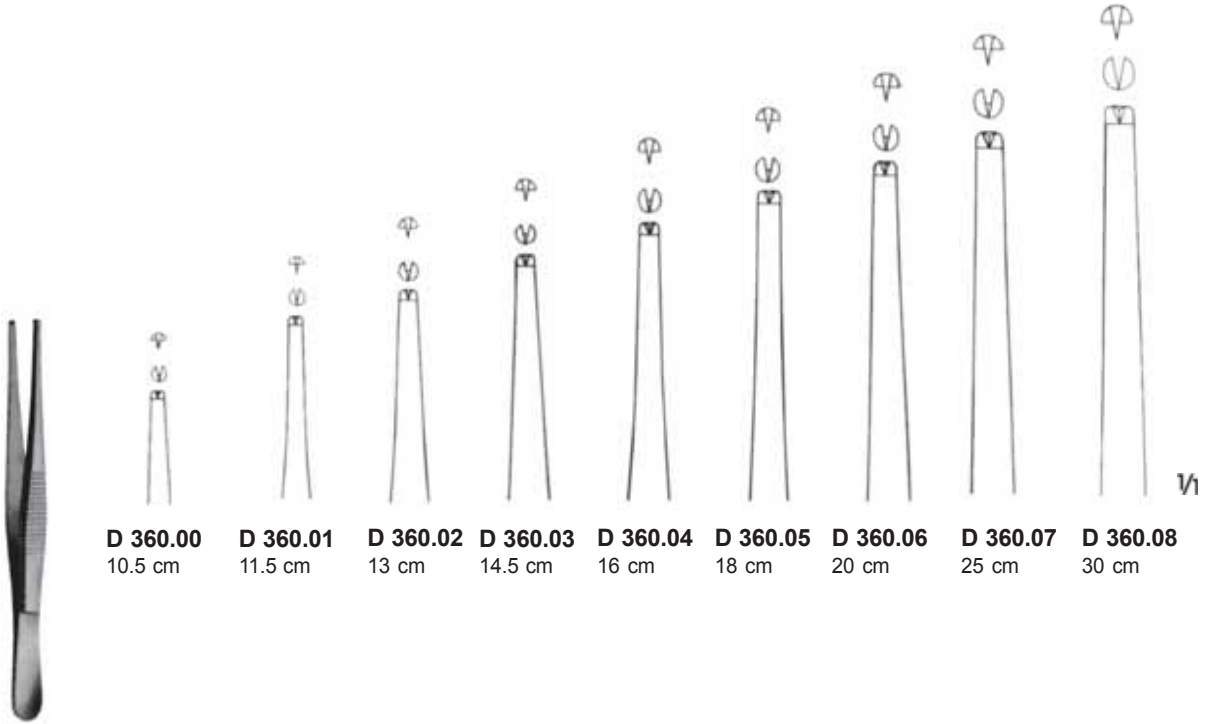

D 360.00 10.5 cm **D 360.01** 11.5 cm **D 360.02** 13 cm **D 360.03** 14.5 cm **D 360.04** 16 cm **D 360.05** 18 cm **D 360.06** 20 cm **D 360.07** 25 cm **D 360.08** 30 cm

STANDART
D 360.00- D 360.08

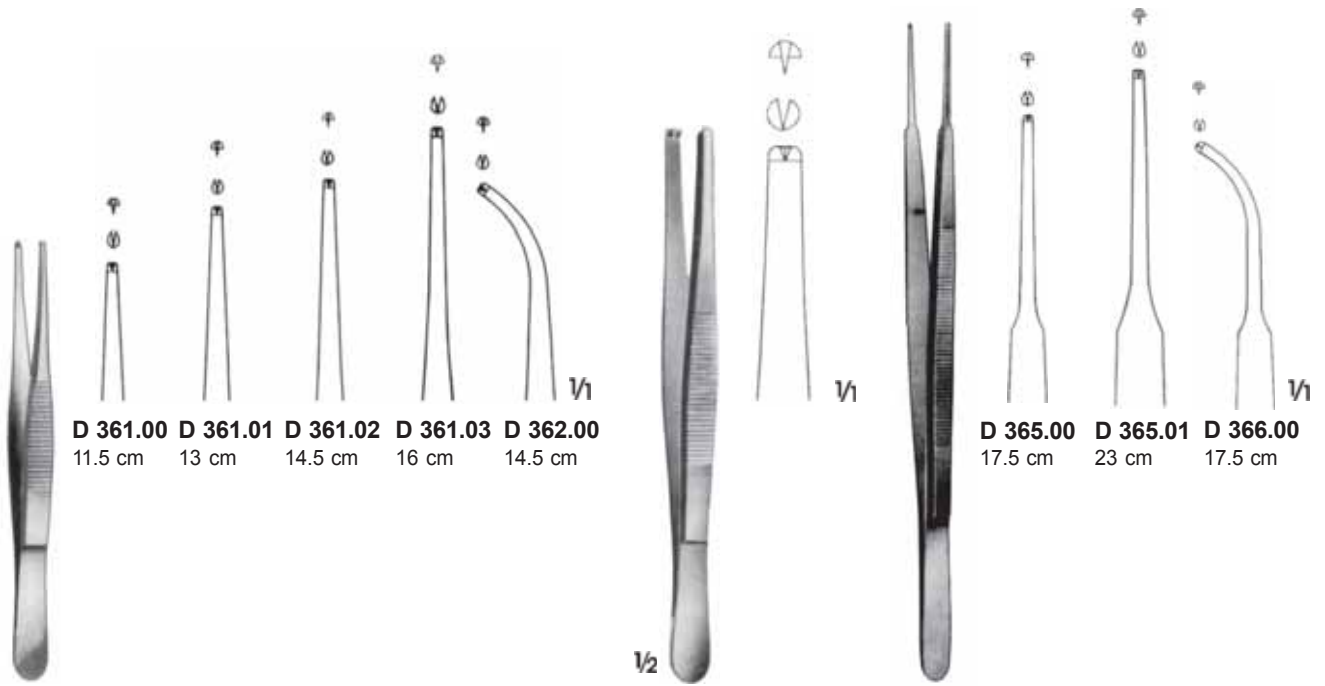

D 361.00 11.5 cm **D 361.01** 13 cm **D 361.02** 14.5 cm **D 361.03** 16 cm **D 362.00** 14.5 cm

D 361.00 - D 362.00

D 364.00
14.5 cm

GERALD
D 365.00 - D 366.00

D 365.00 17.5 cm **D 365.01** 23 cm **D 366.00** 17.5 cm



D 368.00
20 cm

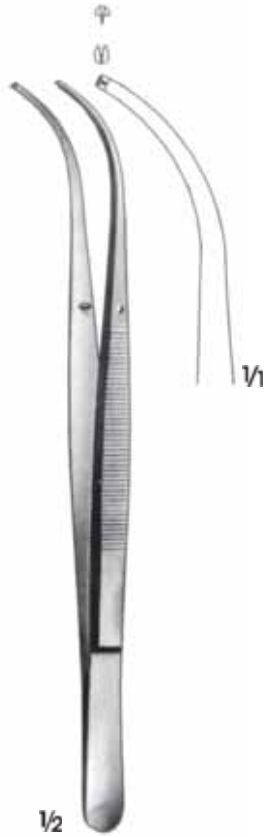

**BROPHY
D 369.00**
20 cm



D 370.00 - D 370.04
2 X 3 Diş/2 x 3 Teeth

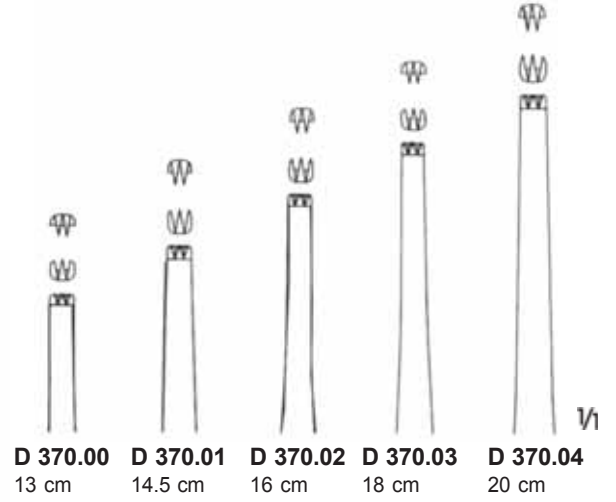

D 370.00 13 cm
D 370.01 14.5 cm
D 370.02 16 cm
D 370.03 18 cm
D 370.04 20 cm

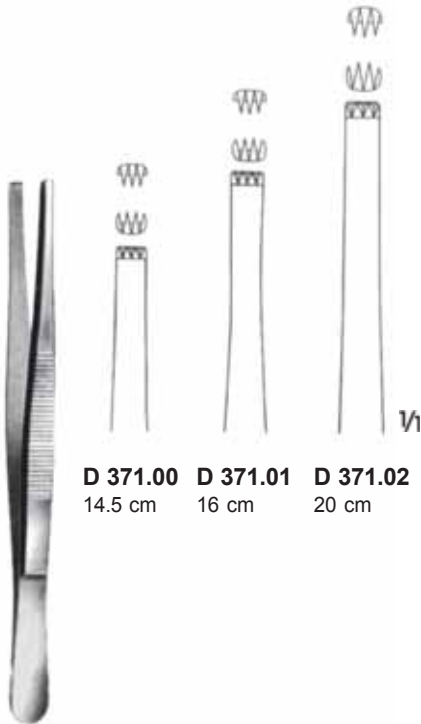

D 371.00 14.5 cm
D 371.01 16 cm
D 371.02 20 cm

**STANDART
D 371.00 - D 371.02**
3 X 4 Diş/3 x 4 Teeth



D 373.00
4 X 5 Diş/3 x 4 Teeth
14.5 cm



D 387.00 15 cm
D 387.01 20 cm

**STRASSBURGER MODEL
D 387.00-D 387.01**

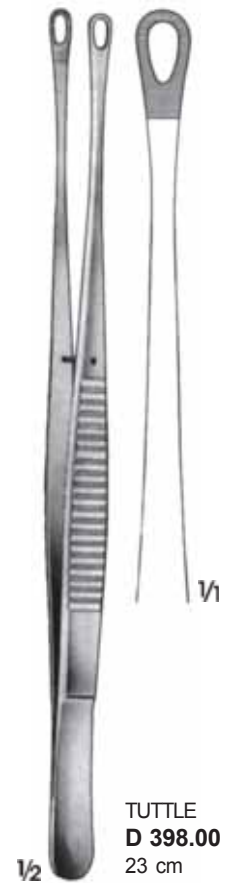
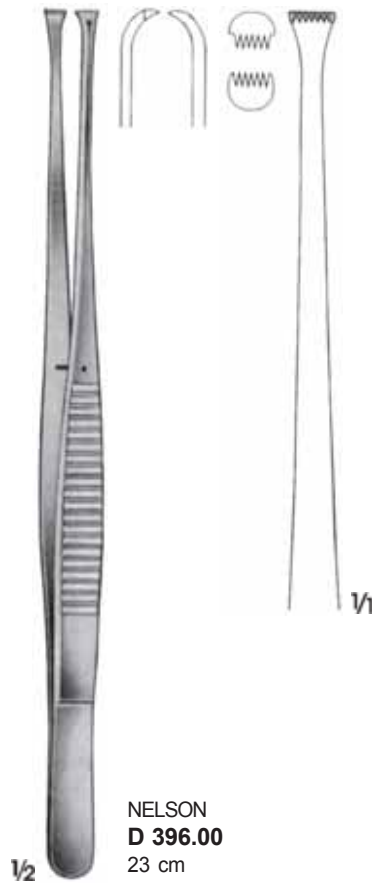
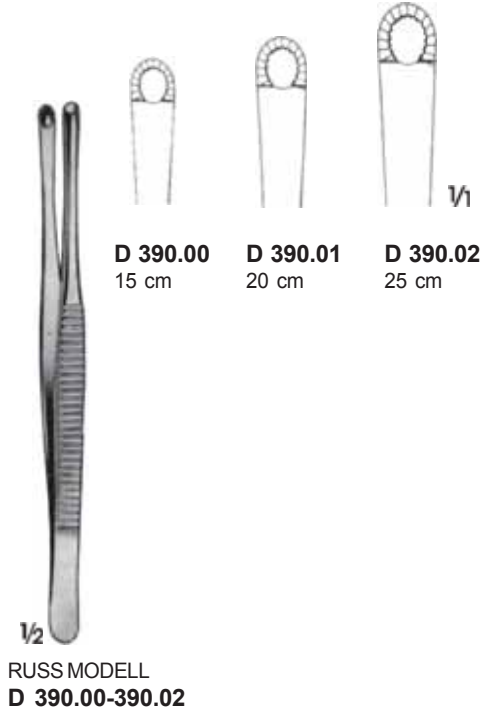
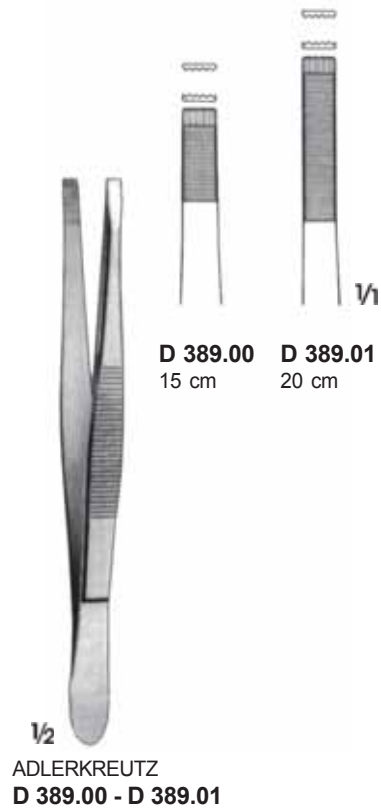

Sert Metal Ağızlı/Hard Metal Edged

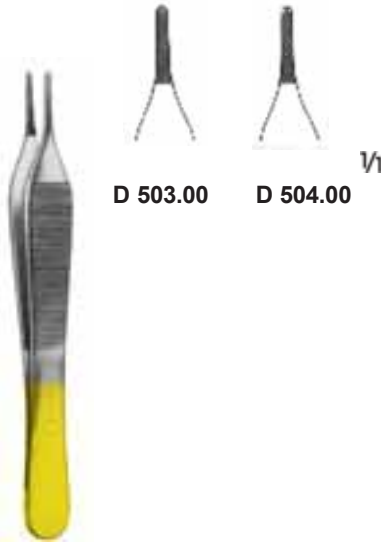

ADSON
D 503.00 - D 504.00
12 cm

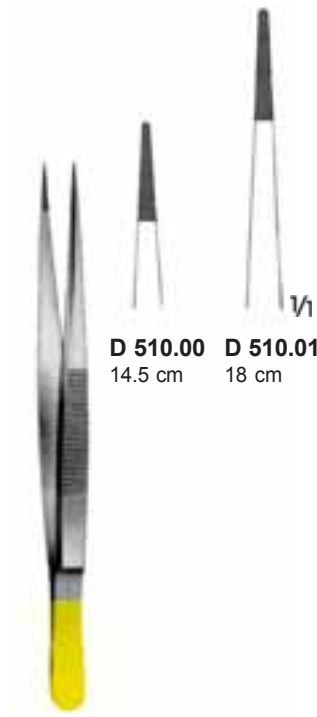

D 510.00 - D 510.01

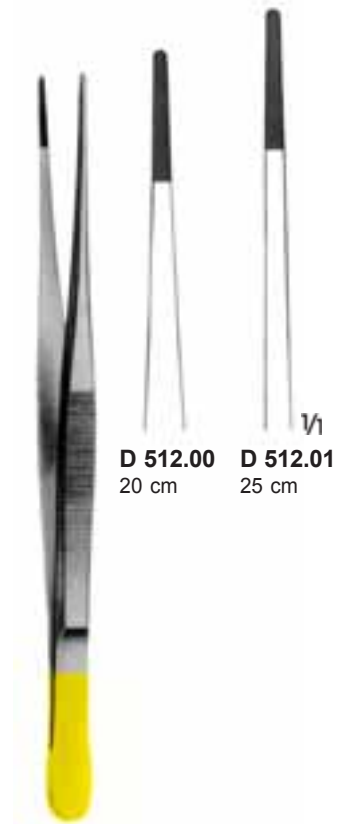

D 512.00 - D 512.01

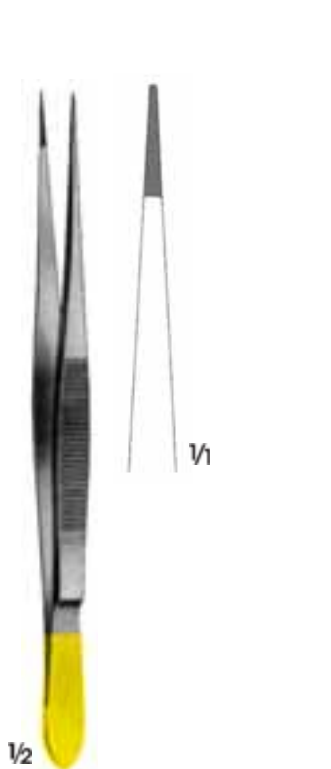

CUSHING
D 513.00
18 cm

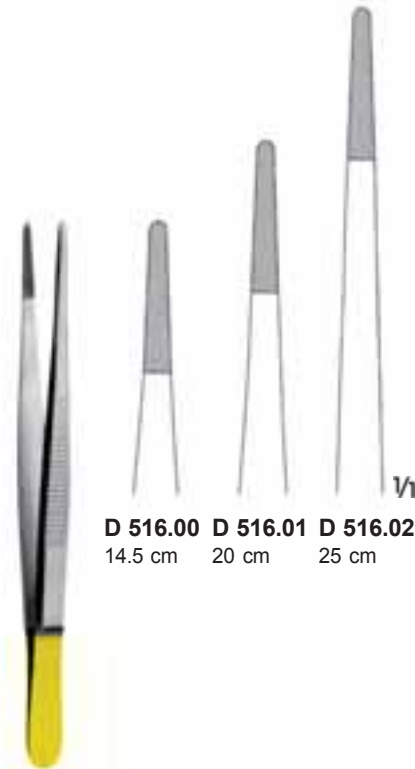

STANDARD
D 516.00-D 516.02

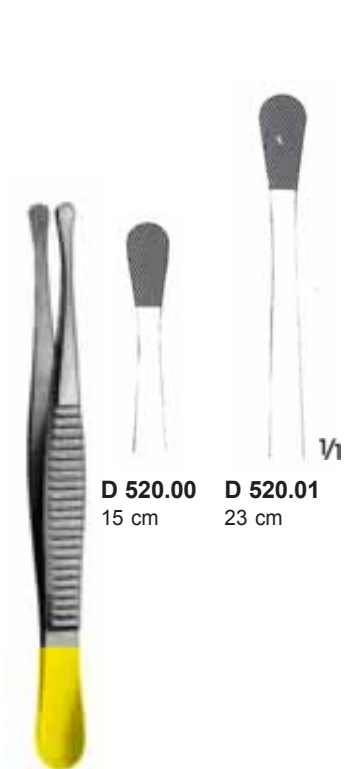

WANGENSTEEN
D 520.00-D 520.01

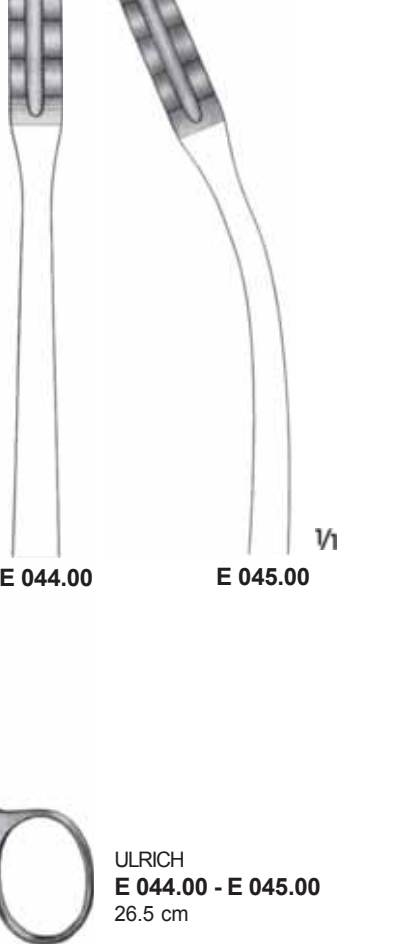
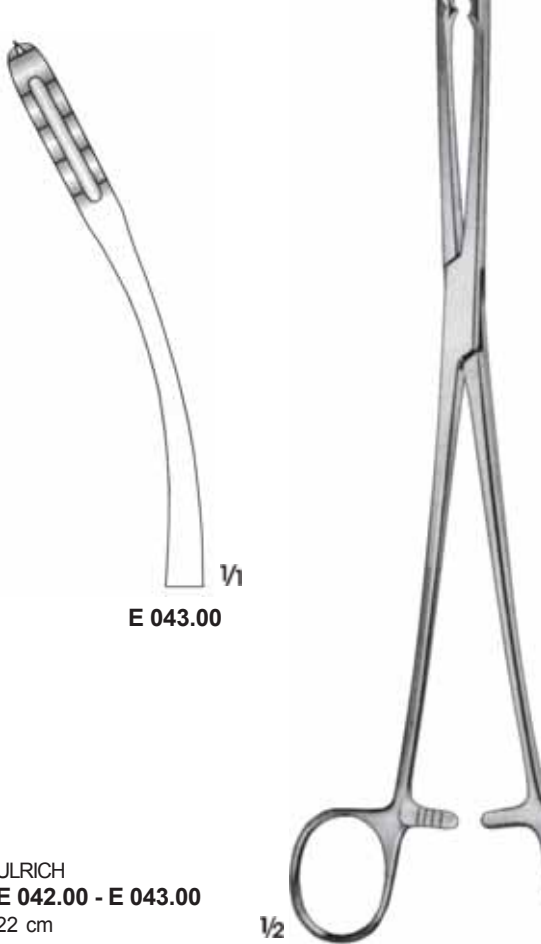
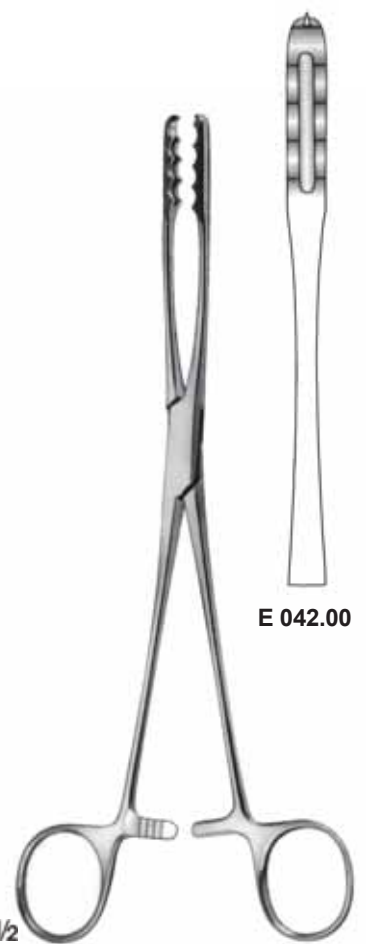
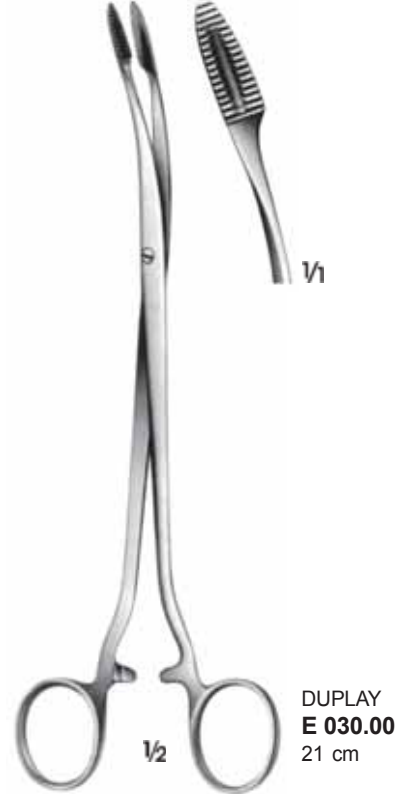

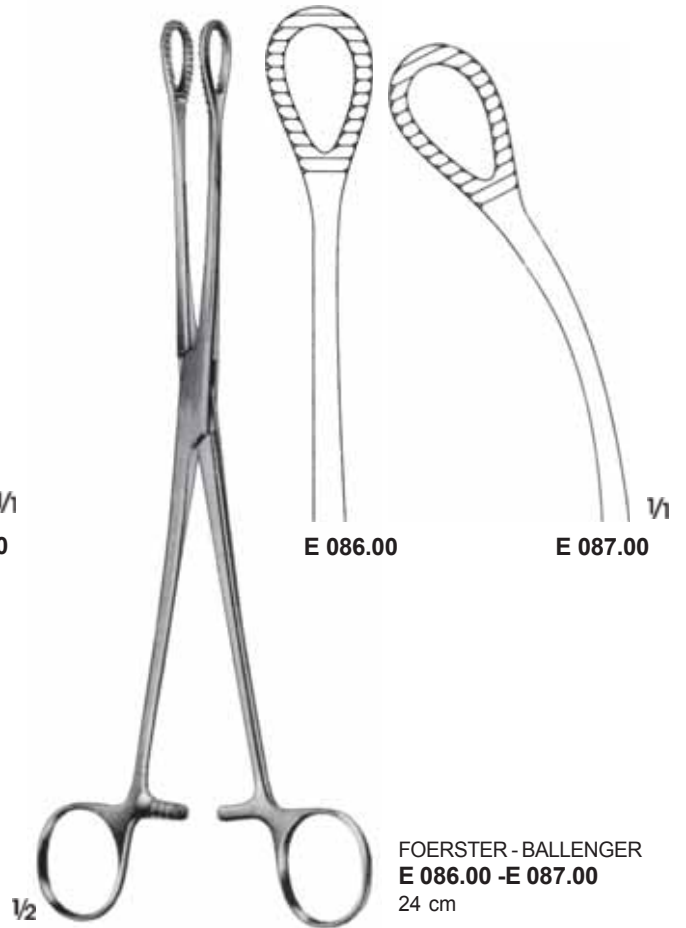
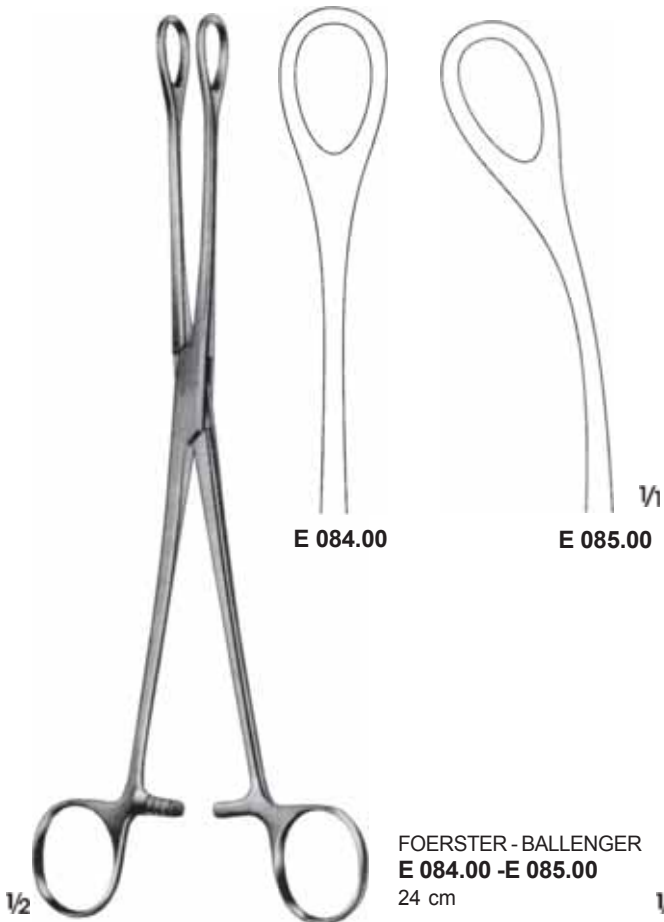
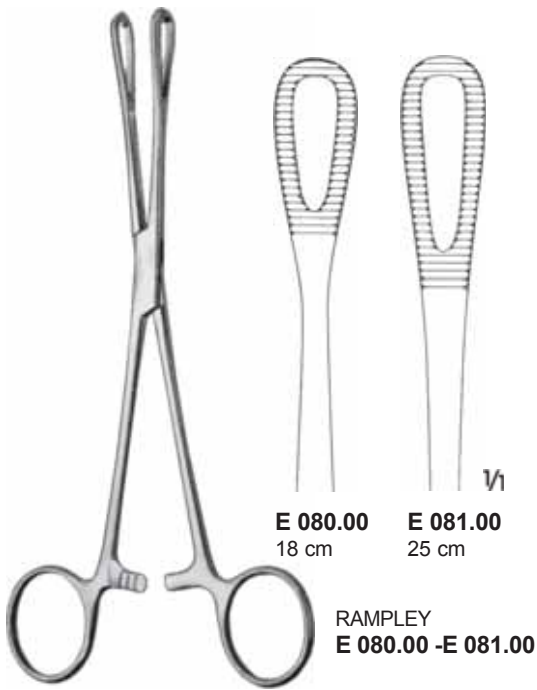



BOYS-ALLIS
E 143.00
 5 X 6 Diş/5 X 6 Teeth
 15.5 cm

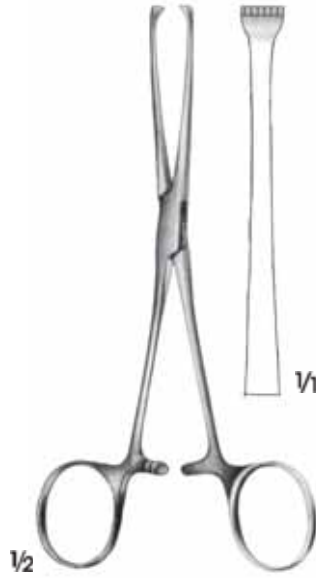

ALLIS
E 144.00
 5 X 6 Diş/5 X 6 Teeth
 15.5 cm



ALLIS
E 145.00
 4 X 5 Diş/4 X 5 Teeth
 15.5 cm



ALLIS
E 150.00-E 150.08



ALLIS
E 147.01
 5 x 6 Diş/5 x 6 Teeth
 19 cm



BABCOCK
E 170.00
15.5 cm



ALLIS -THOMS
E 158.00
6 X 7 Diş/6 X 7 Teeth
20 cm

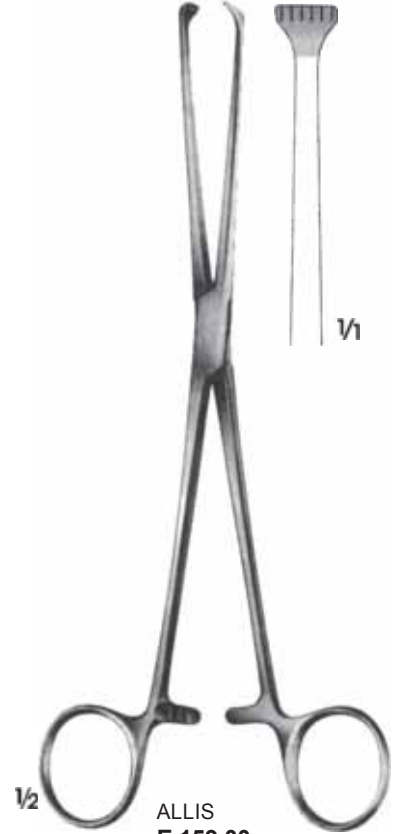

ALLIS
E 159.00
22 cm

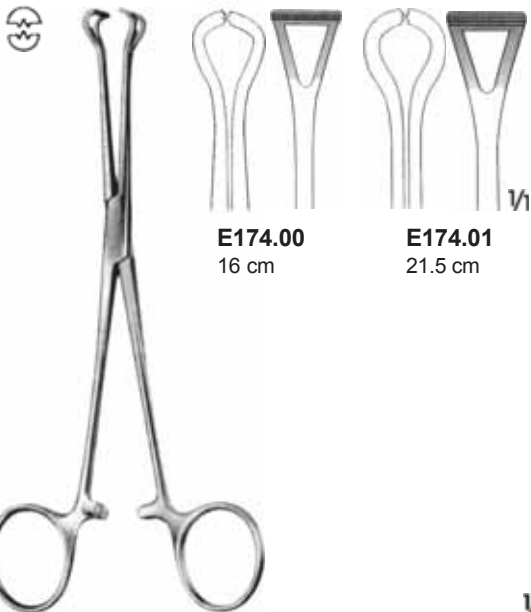

E174.00
16 cm

E174.01
21.5 cm

BABCOCK
E174.00 - E 174.01



BABCOCK
E171.00
17 cm



BABCOCK
E171.01
21.5 cm

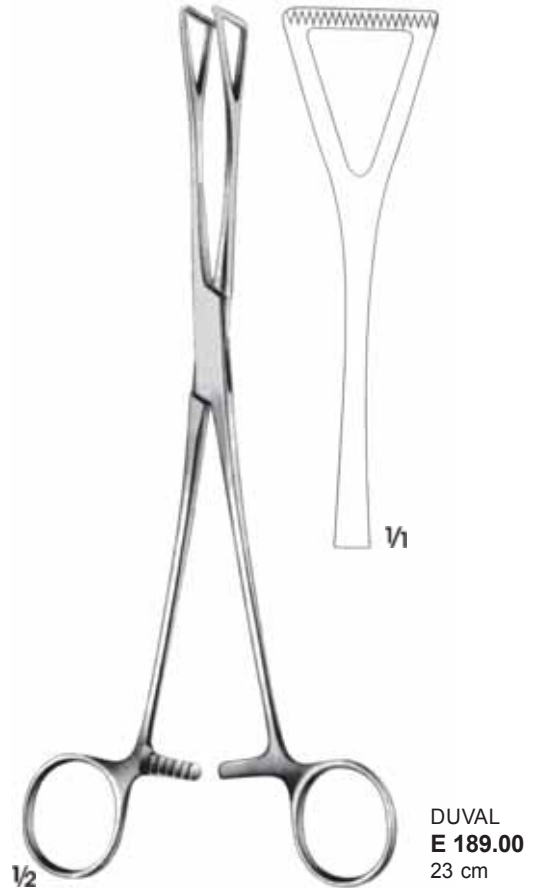
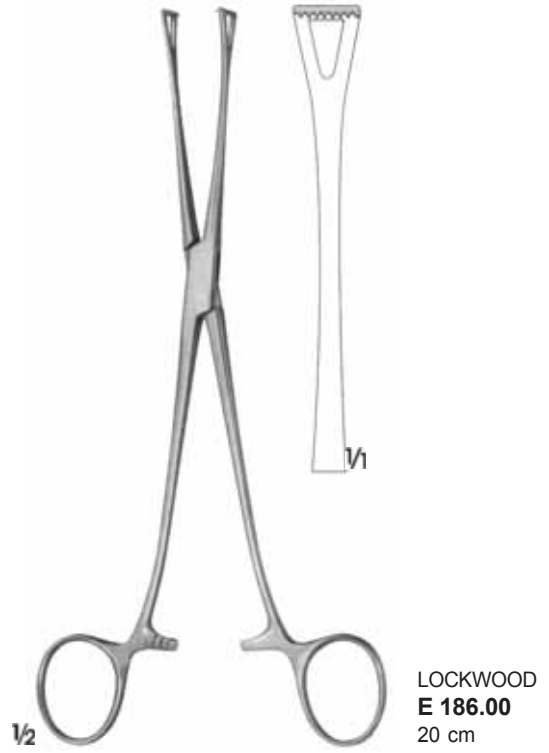
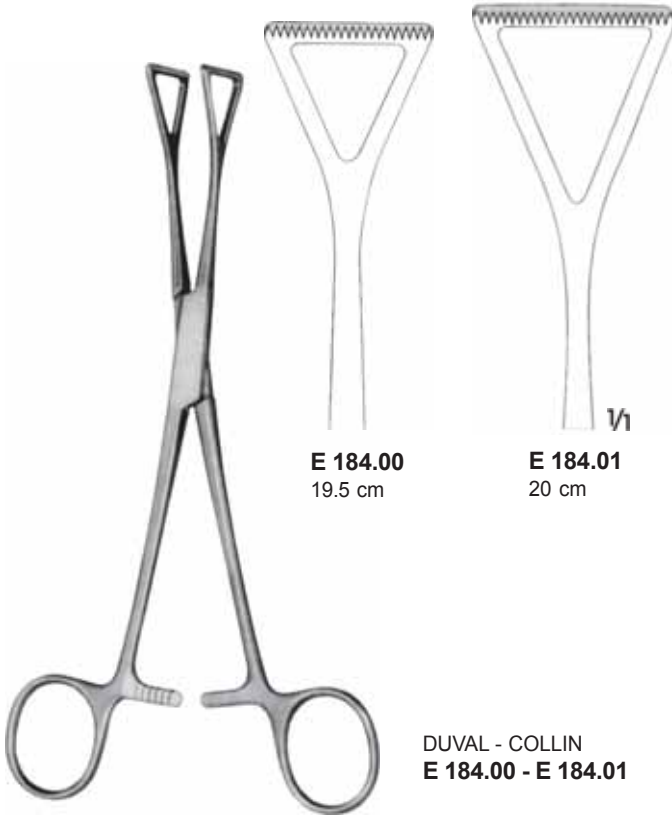



JAGER
E 330.00
Esnek şaft/Flexible shaft
27.5 cm

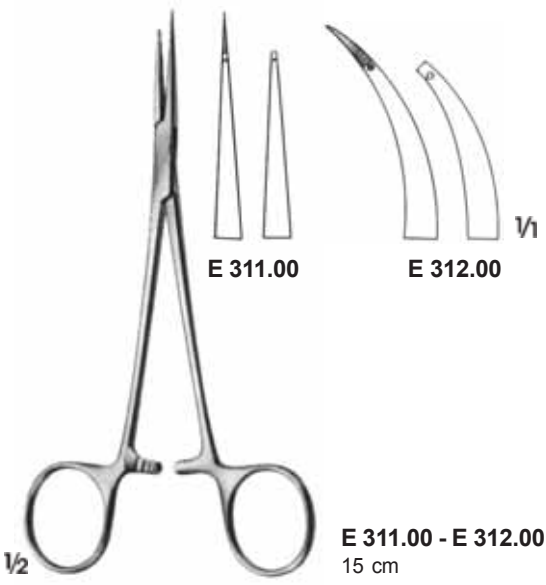

E 311.00

E 312.00

E 311.00 - E 312.00
15 cm

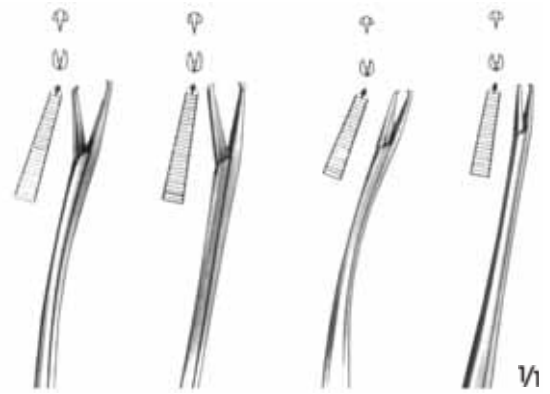

E 331.00
18.5 cm

E 331.01
18.5 cm

E 332.00
15 cm

E 332.01
15 cm



E 302.00

E 302.01

HERZ
E 302.00 - E 302.01
15.5 cm



BRAND
E 331.00 - E 332.01

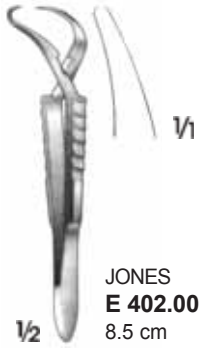

JONES
E 402.00
8.5 cm



SCHAEDEL
E 403.00 - E404.00
8.5 cm

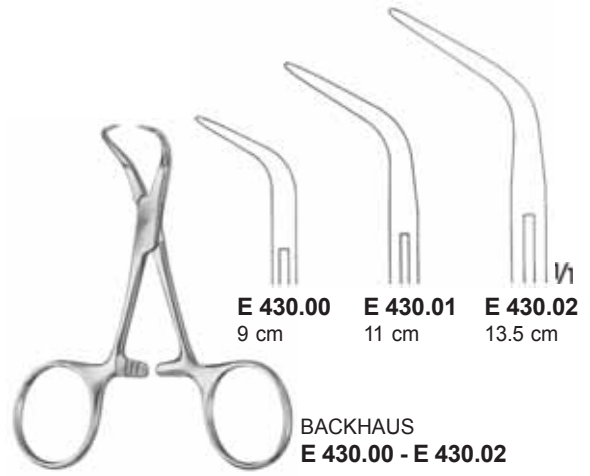

BACKHAUS
E 430.00 - E 430.02
9 cm 11 cm 13.5 cm

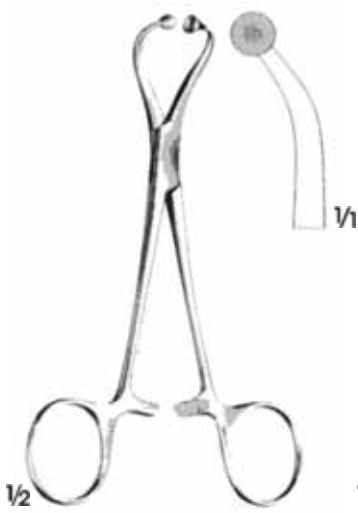

E 440.00
14 cm

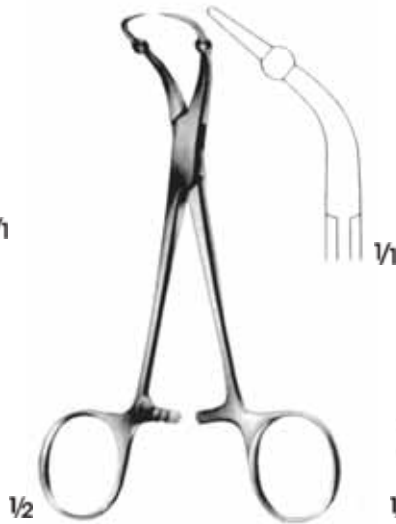

ROEDER
E 442.00
13.5 cm

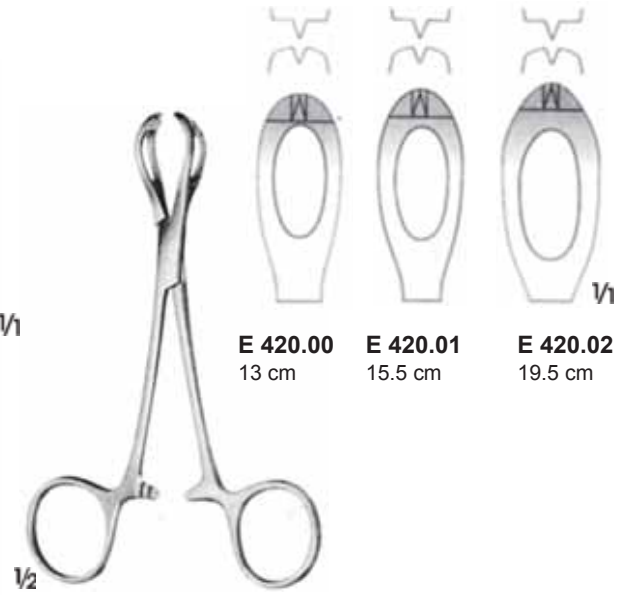

LANE
E 420.00 - E 420.02
13 cm 15.5 cm 19.5 cm



E 450.00
11 cm



ROBIN
E 451.01
13.5 cm



ROBIN
E 451.00
13.5 cm



BUNT
E 480.00
10.5 cm

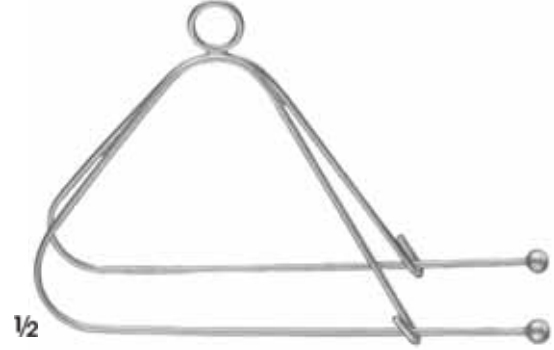

MAYO
E 482.00
12.5 cm



MAYO
E 481.00
14 cm

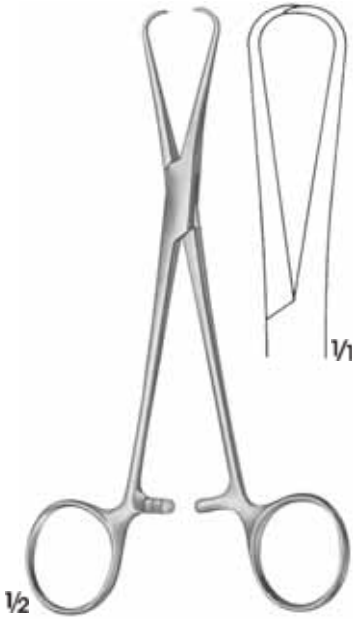

BERNHARD
E 444.00
16 cm



G 883.00
tüp klempi, Düz Ağız
tubing clamp forceps, Smooth Jaws
16.5 cm



G 884.00 - G 884.02
Tüp klempi, Ağızları tırtıllı
Tubing clamp forceps, Serrated jaws

G 884.00
15 cm

G 884.01
18 cm

G 884.02
20 cm



BIEMER-MULLER
S 010.00
Çene uzunluğu / Length of jaws 6 mm
Açıklık / Opening 4 mm
Kapanma kuvveti / closing force 30-40 gr.



BIEMER-MULLER
S 011.00
Çene uzunluğu / Length of jaws 4,5 mm
Açıklık / Opening 3 mm
Kapanma kuvveti / closing force 25-30 gr.



BIEMER-MULLER
S 012.00
Çene uzunluğu / Length of jaws 9 mm
Açıklık / Opening 5 mm
Kapanma kuvveti / closing force 25-30 gr.



BIEMER-MULLER
S 013.00
Çene uzunluğu / Length of jaws 9 mm
Açıklık / Opening 5 mm
Kapanma kuvveti / closing force 25-30 gr.



BIEMER-MULLER
S 014.00
Çene uzunluğu / Length of jaws 9 mm
Açıklık / Opening 5 mm
Kapanma kuvveti / closing force 25-30 gr.



BIEMER-MULLER
S 015.00
Çene uzunluğu / Length of jaws 9 mm
Açıklık / Opening 5 mm
Kapanma kuvveti / closing force 25-30 gr.

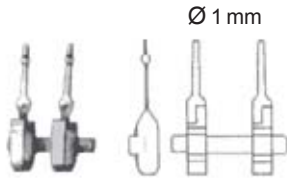

MULLER
S 020.00
Kapanma kuvveti / closing force 25-30 gr.

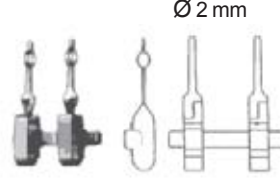

MULLER
S 021.00
Kapanma kuvveti / closing force 25-30 gr.



S 030.00
Approximator

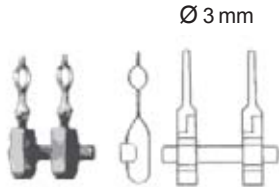

MULLER
S 022.00
Kapanma kuvveti / closing force 25-30 gr.

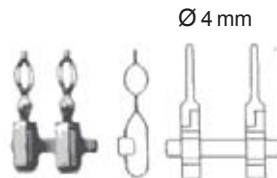

MULLER
S 023.00
Kapanma kuvveti / closing force 25-30 gr.



BIEMER
S 024.00
Approximator
14.5 cm



S 025.00
Komple Aproksimatör,
anahtarı ile
S 029.00
Approximator, complete, with key
S 029.00



BIEMER
S 026.00
Komple Aproksimatör,
anahtarı ile
S 029.00
Approximator, complete, with key
S 029.00

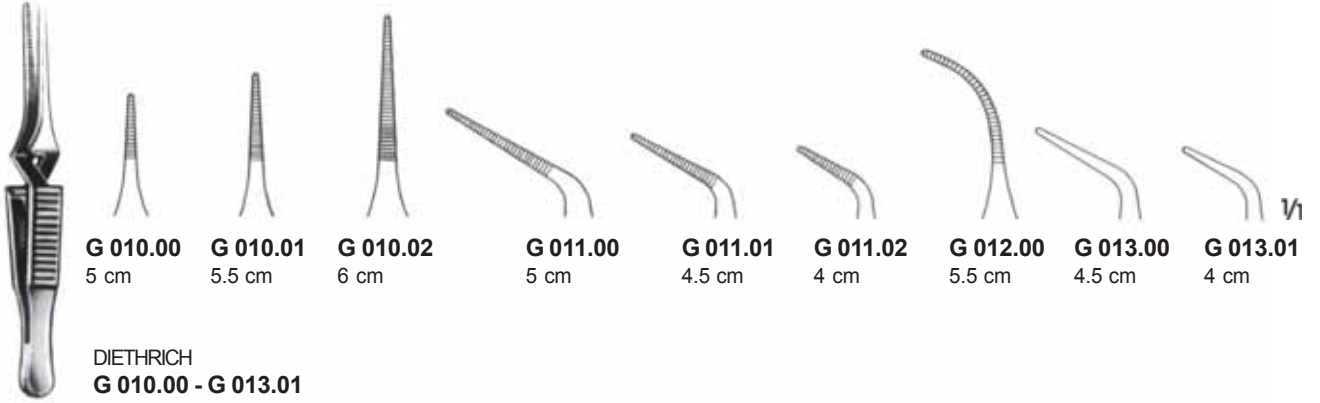

G 010.00 5 cm **G 010.01** 5.5 cm **G 010.02** 6 cm **G 011.00** 5 cm **G 011.01** 4.5 cm **G 011.02** 4 cm **G 012.00** 5.5 cm **G 013.00** 4.5 cm **G 013.01** 4 cm

DIETHRICH
G 010.00 - G 013.01



DIEFFENBACH
G 020.00 4 cm
G 020.01 5 cm



DIEFFENBACH
G 021.00 4 cm
G 021.01 5 cm



$\frac{1}{2}$
DIEFFENBACH
G 022.00 6 cm



$\frac{1}{2}$
DIEFFENBACH
G 023.00 6 cm



JOHNS-HOPKINS
G 024.00 38 mm
G 024.01 48 mm
G 024.02 56 mm
G 024.03 63 mm
G 024.04 70 mm
G 024.05 80 mm
G 024.06 91 mm



$\frac{1}{2}$
DE BAKEY-HESS
G 030.00
Uc Uzunluğu: 2cm
Length of Jaws : 2 cm



$\frac{1}{2}$
DE BAKEY-HESS
G 030.01
Uc Uzunluğu : 3 cm
Length of Jaws : 3 cm



$\frac{1}{2}$
JOHNS-HOPKINS
G 026.00
24 cm

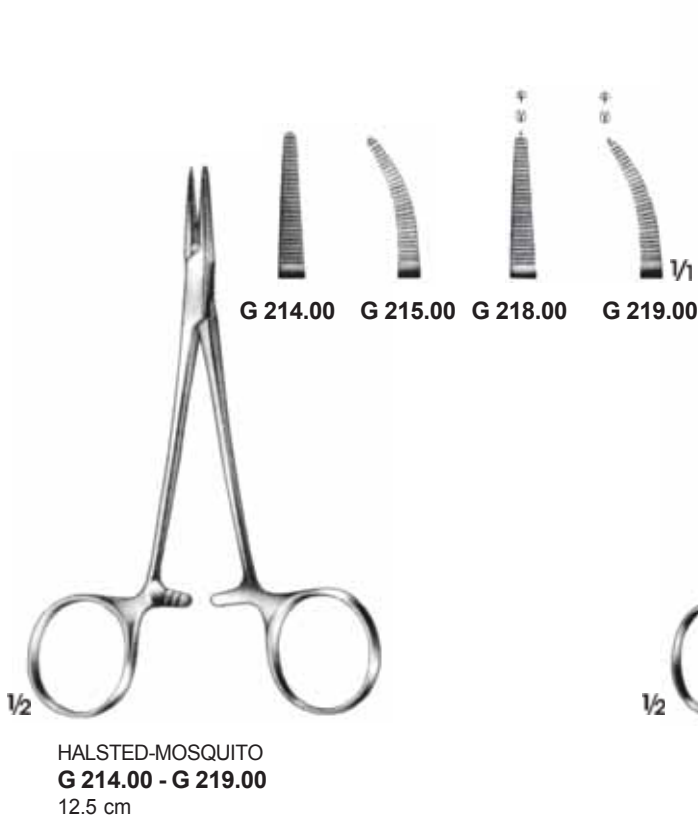
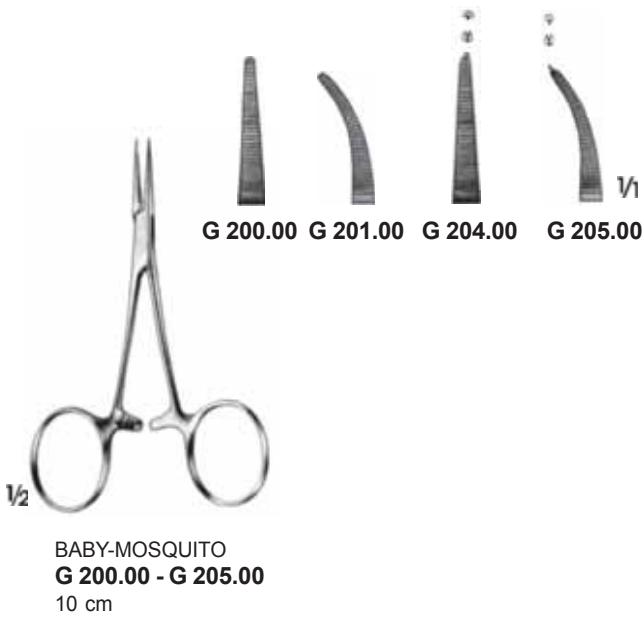



PROVIDENCE-HOSPITAL
G 230.00-G 231.00
14 cm



LERICHE
G 250.00-G 255.00
15 cm



KELLY
G 234.00 - G 235.00
14 cm



GREY-TURNER
G 286.00
18 cm



HALSTED
G 280.00 - G 281.00
18.5 cm



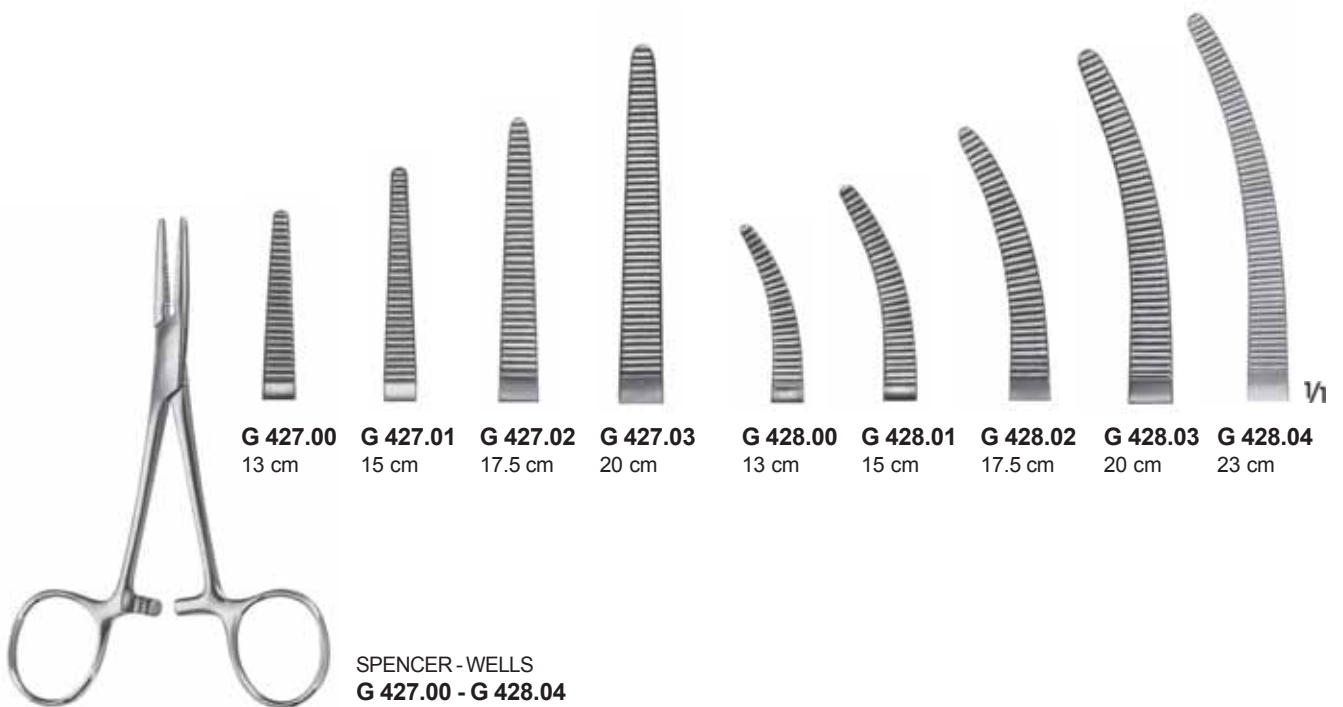

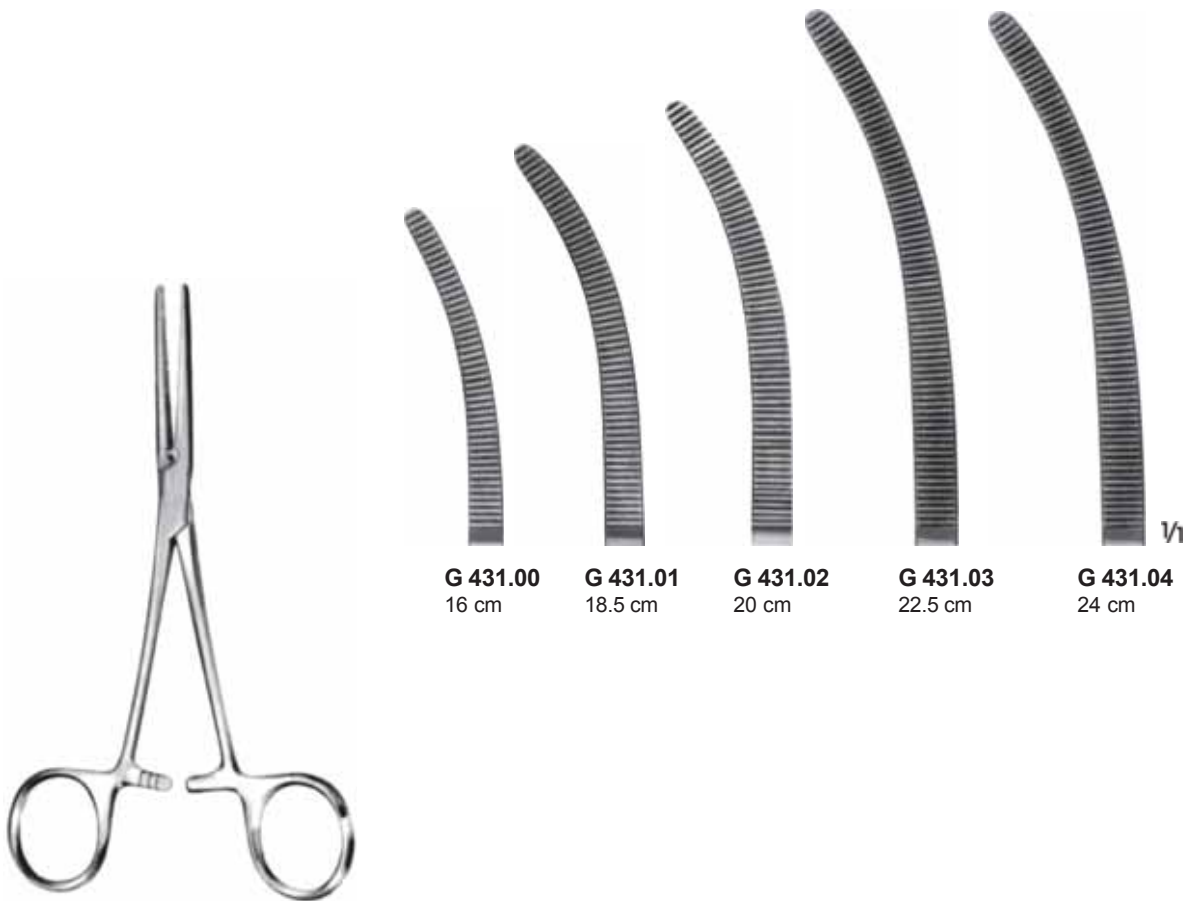
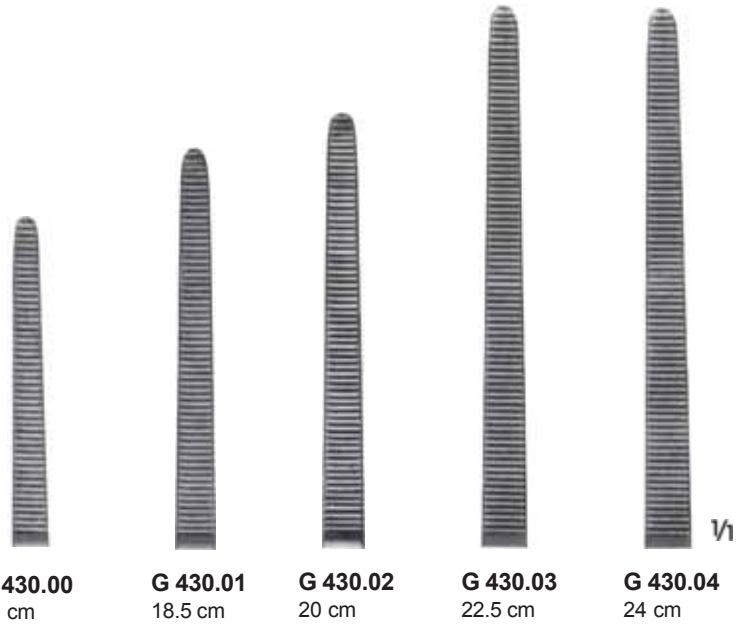

**ROCHESTER - PEAN
G 430.00 - G 431.04**

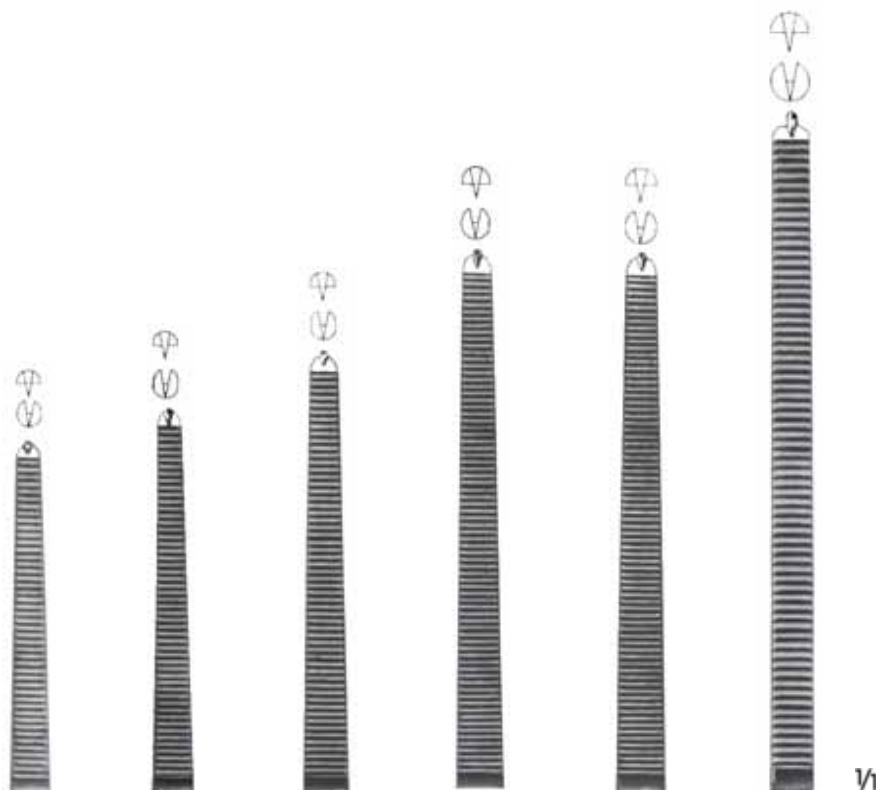

G 448.00 16 cm **G 448.01** 18.5 cm **G 448.02** 20 cm **G 448.03** 22.5 cm **G 448.04** 24 cm **G 448.05** 26 cm

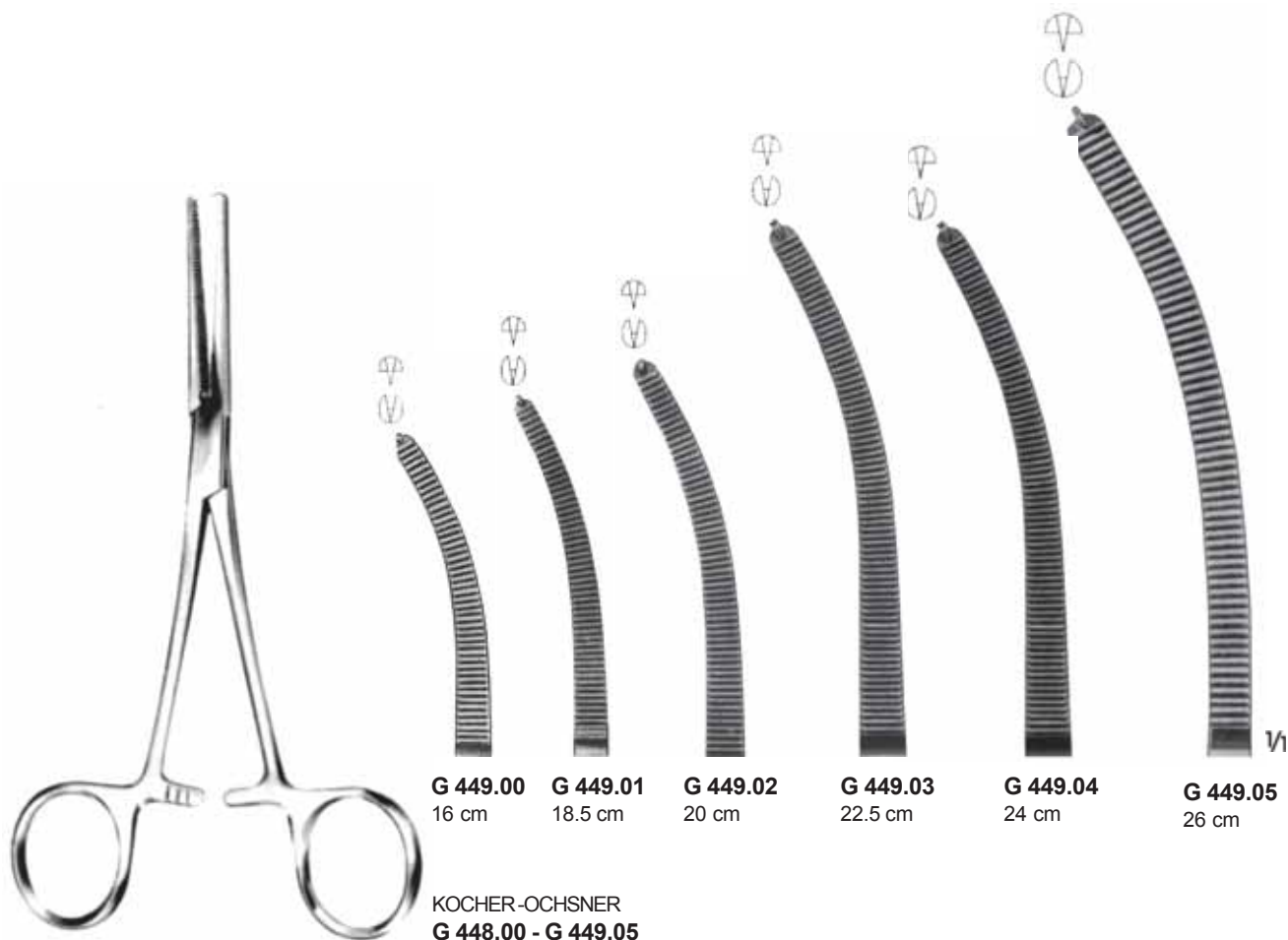

G 449.00 16 cm **G 449.01** 18.5 cm **G 449.02** 20 cm **G 449.03** 22.5 cm **G 449.04** 24 cm **G 449.05** 26 cm

KOCHER-OCHSNER
G 448.00 - G 449.05



MICRO-ADSON
G 614.00
 14 cm



BABY-OVERHOLT
G 615.00
 13.5 cm



G 616.00 14 cm
G 616.01 18 cm



BABY-ADSON
G 617.00
 14 cm



G 618.00 18.5 cm
G 618.01 21 cm
G 618.02 21.5 cm
G 618.03 22 cm

G 618.00 - G 618.03

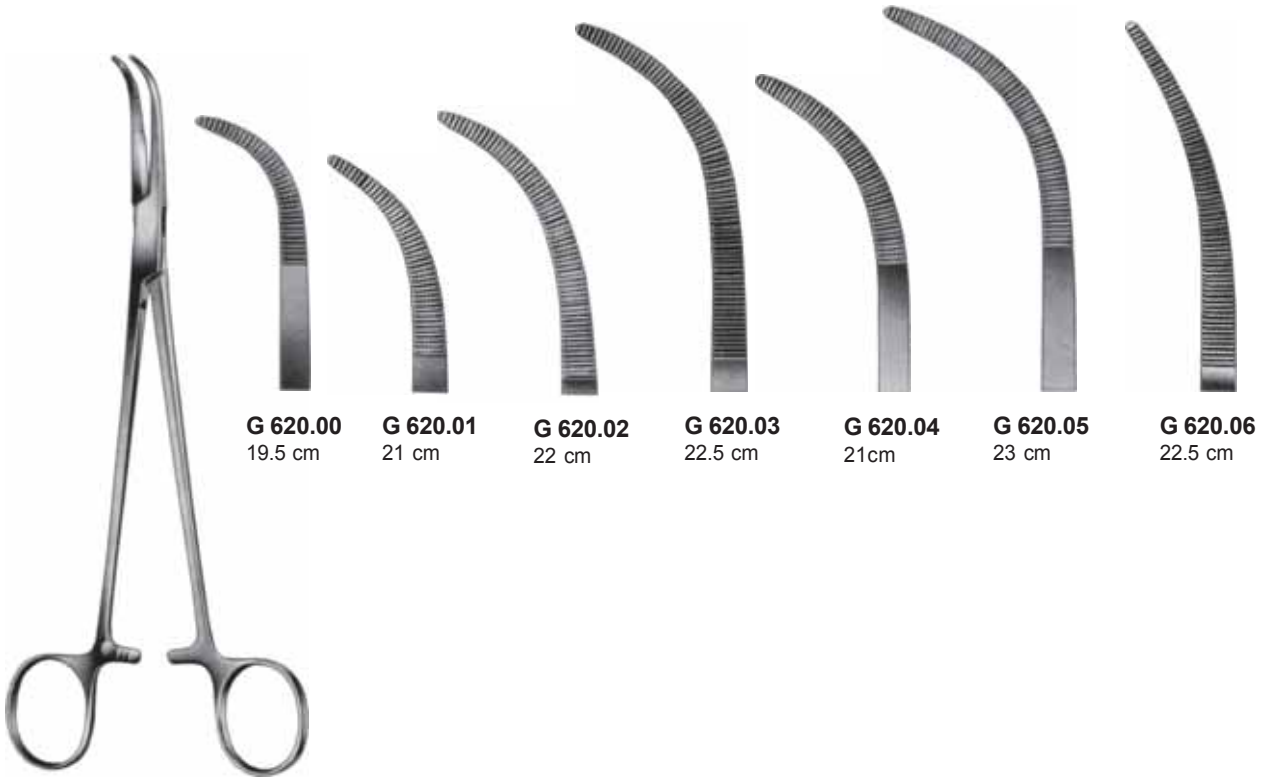

G 620.00
19.5 cm

G 620.01
21 cm

G 620.02
22 cm

G 620.03
22.5 cm

G 620.04
21cm

G 620.05
23 cm

G 620.06
22.5 cm

OVERHOLT - GEISSENDOERFER
G 620.00 - G 620.06



$\frac{1}{2}$ **MIXTER**
G 654.00
23 cm

LAHEY
G 672.00 - G 672.01

MIXTER
G 674.00 - G 674.01

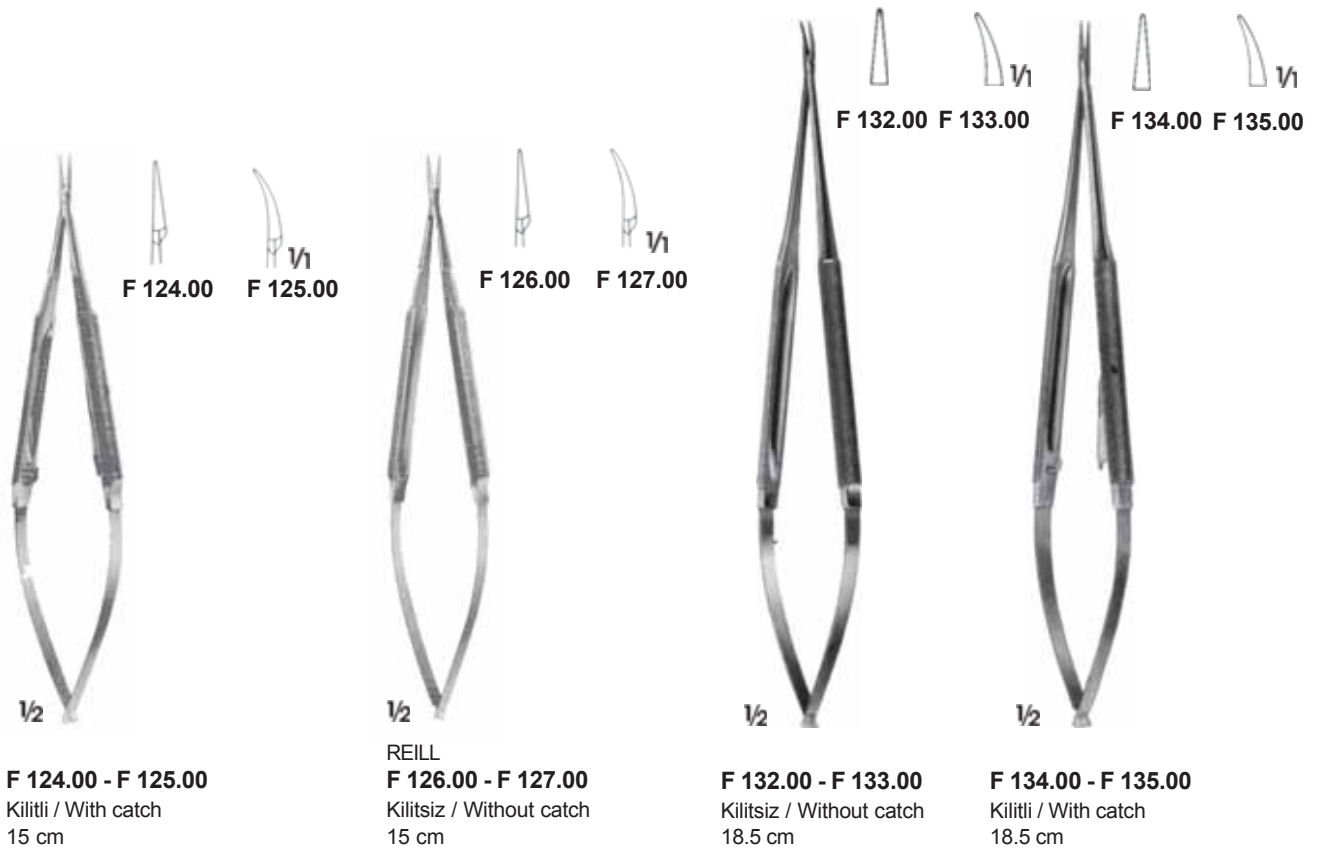
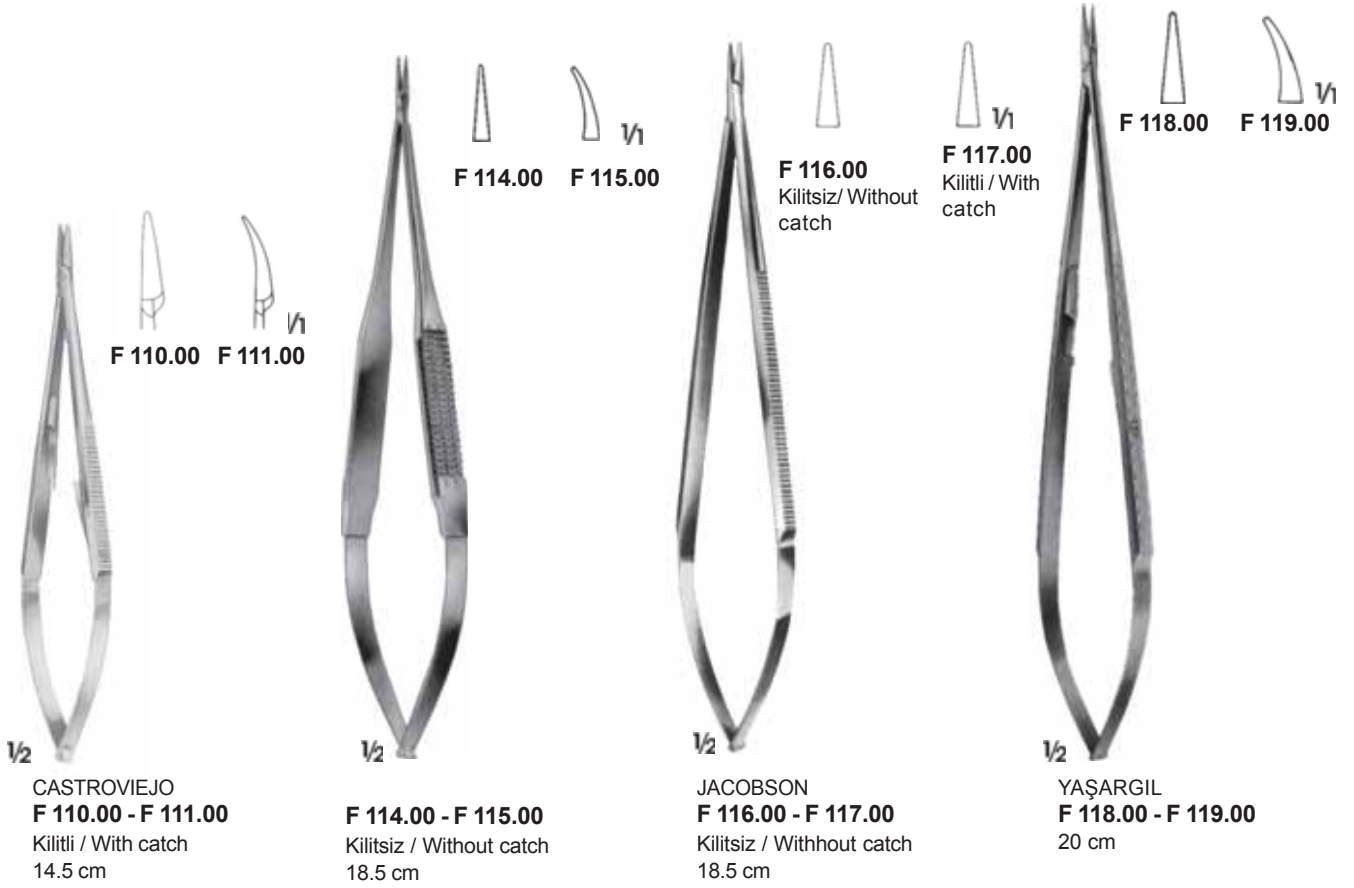

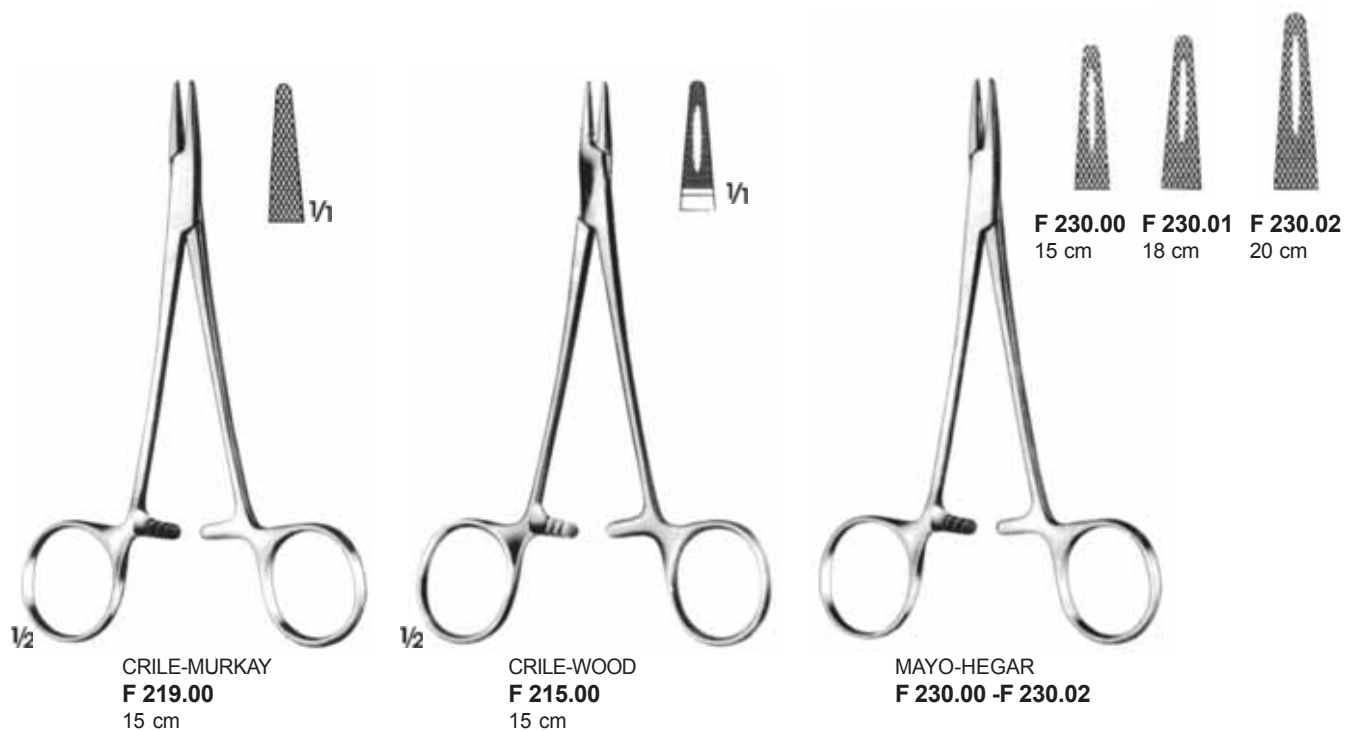
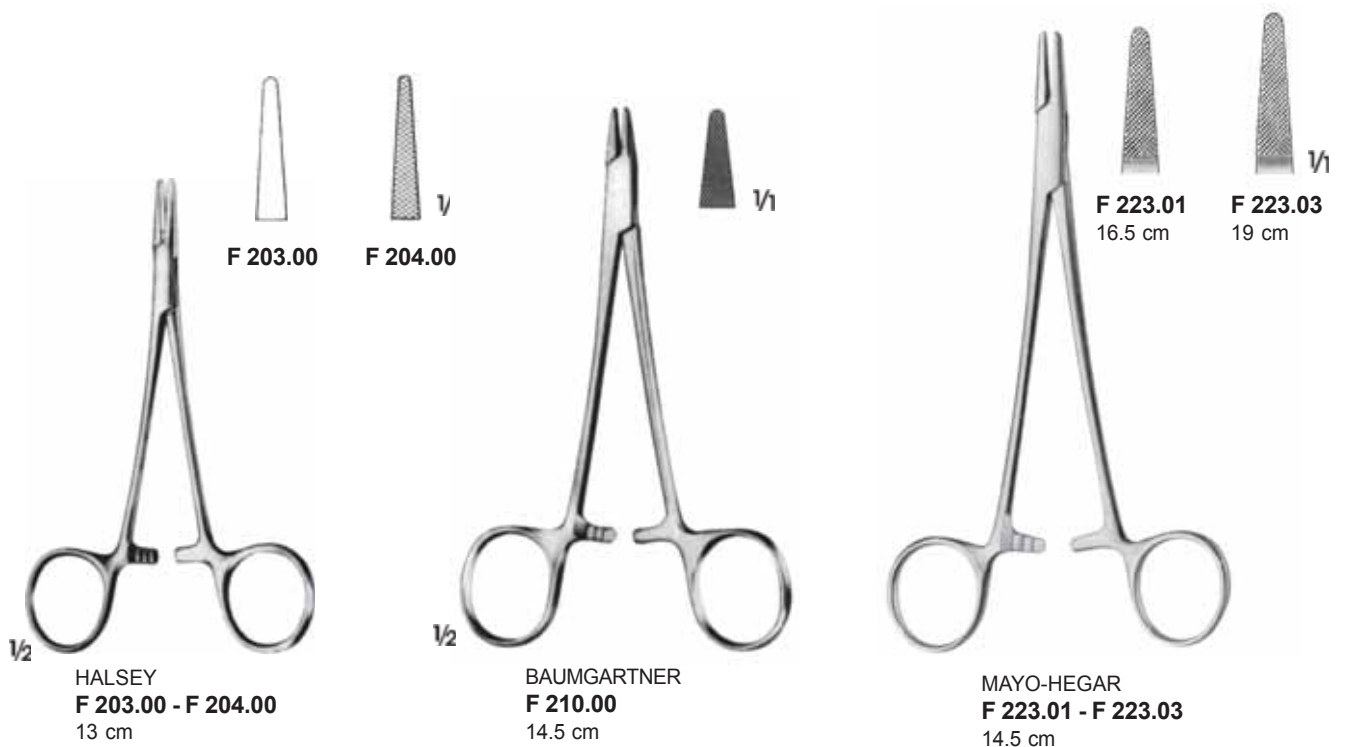



HEANEY(HEGAR)
F 236.00
20 cm



JAMESON
F 237.00
23 cm



MASSON
F 239.00
26.5 cm

Sert Metal Ağızlı / Hard Metal Edges

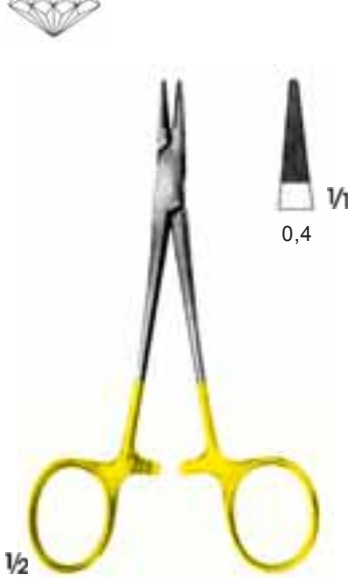

HALSEY
F 325.00
13 cm



BABY-CRILE-WOOD
F 328.00
15 cm

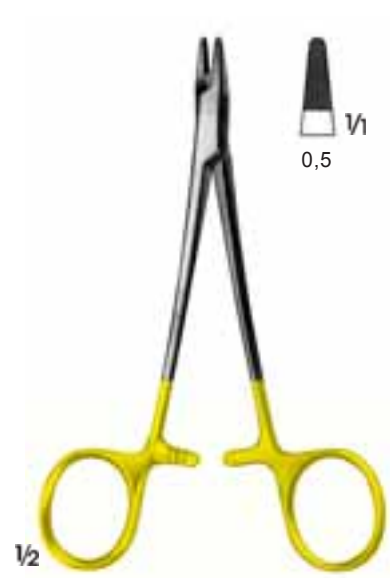

BAUMGARTNER
F 332.00
14.5 cm



F 334.00
15 cm



F 336.00
15 cm

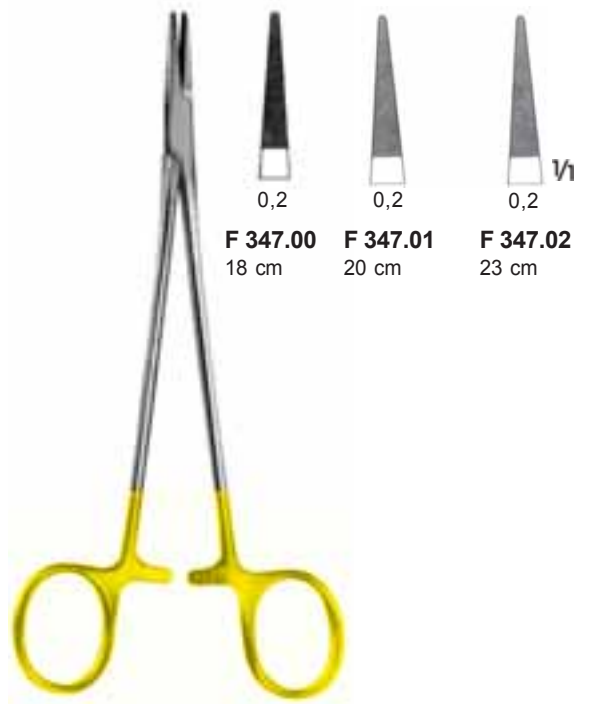

F 347.00 - F 347.02

Sert Metal Ağızlı / Hard Metal Edges



HEGAR-MAYO
F 355.00 - F 355.02

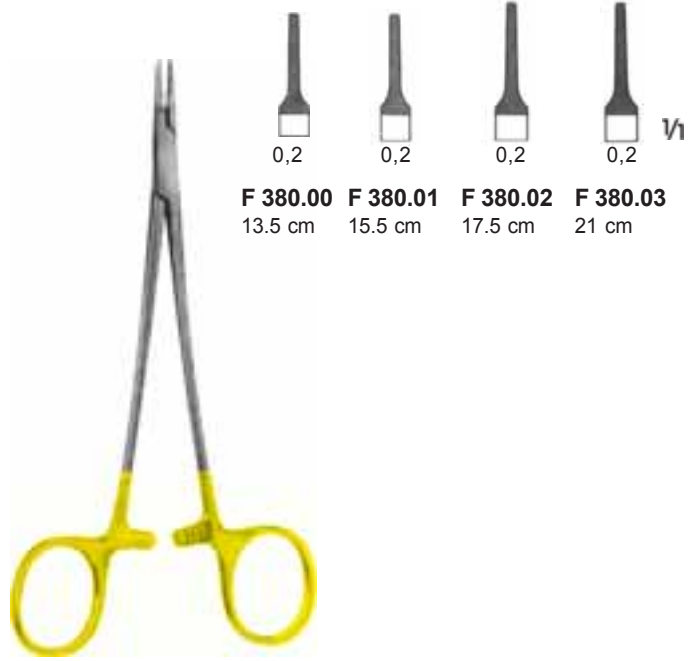

RYDER
F 380.00 - F 380.03

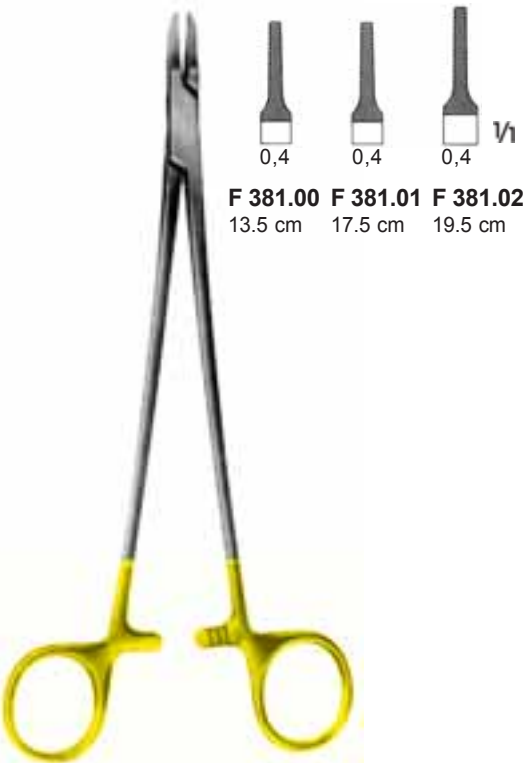

RYDER
F 381.00 - F 381.02

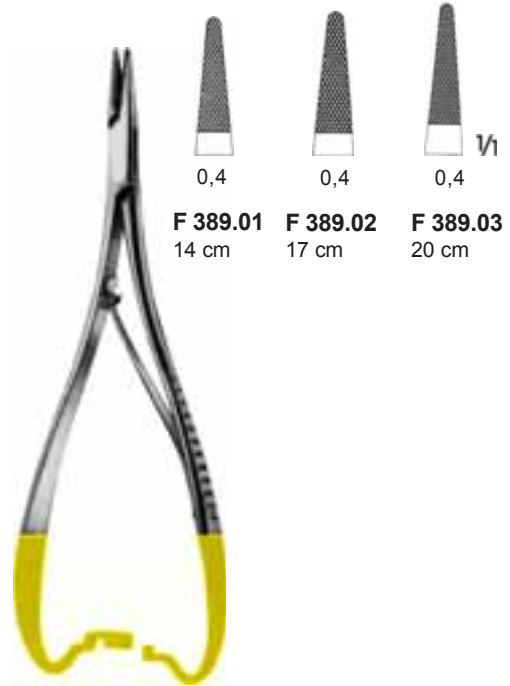

MATHIEU
F 389.01 - F 389.03



CRILE
F 250.00
15 cm



TONNIS
F 251.00
18 cm



MATHIEU
F 285.00 - F 285.02

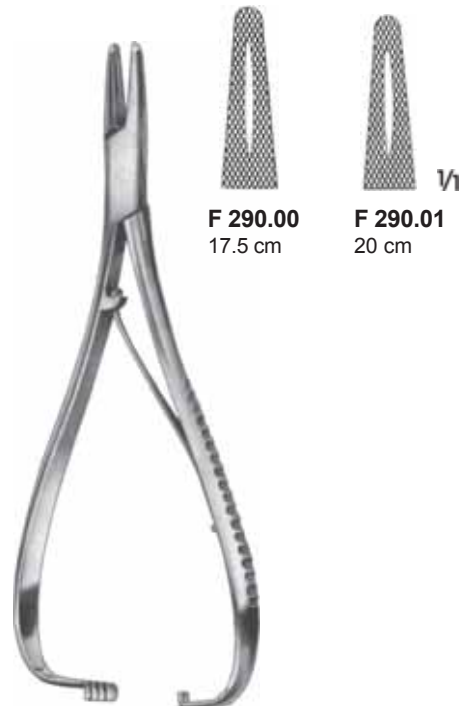

MATHIEU - STILLE
F 290.00 - F 290.01



HURD
F 424.00 Sağ/Right
F 425.00 Sol/Left
Sivri/Sharp
21 cm



DESCHAMPS
F 426.00 Sağ/Right
F 427.00 Sol/Left
Sivri/Sharp
21 cm



DESCHAMPS
F 428.00 Sağ/Right
F 429.00 Sol/Left
Künt/Blunt
22.5 cm



DESCHAMPS
F 432.00 Sağ/Right
F 433.00 Sol/Left
Künt/Blunt
21.5 cm

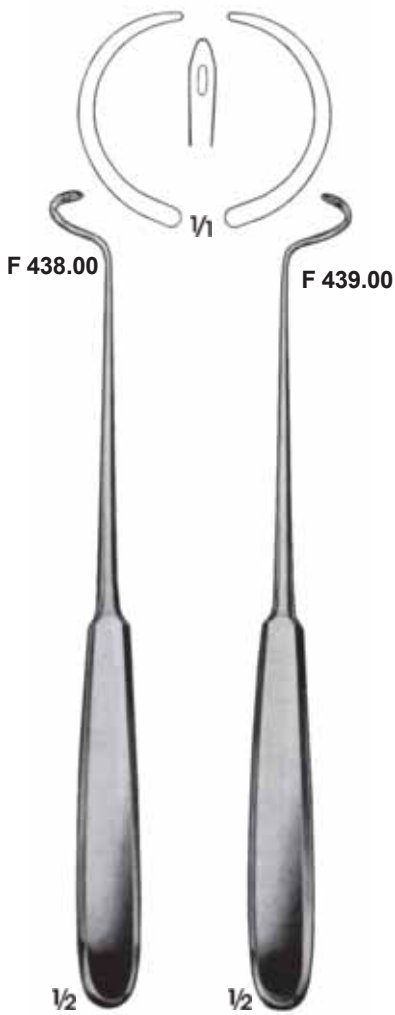

DESCHAMPS
F 438.00 Sağ/Right
F 439.00 Sol/Left
Künt/Blunt
21.5 cm

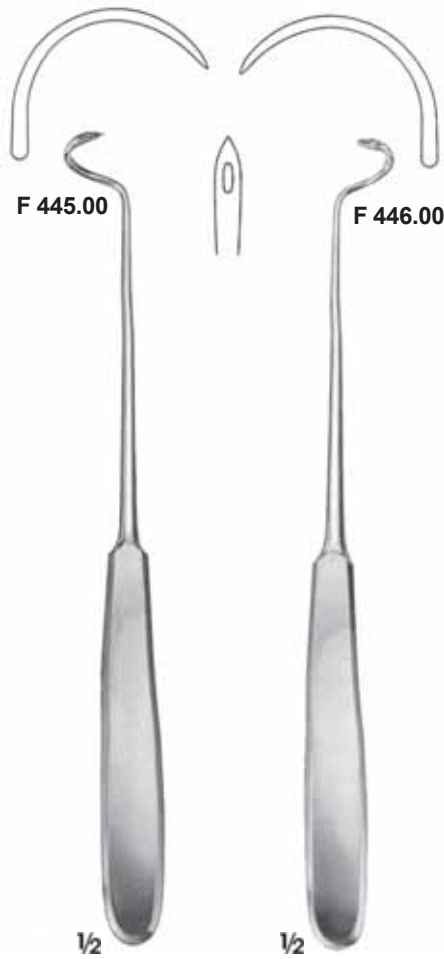

DESCHAMPS
F 445.00 Sağ/Right
F 446.00 Sol/Left
Sivri/Sharp
21.5 cm

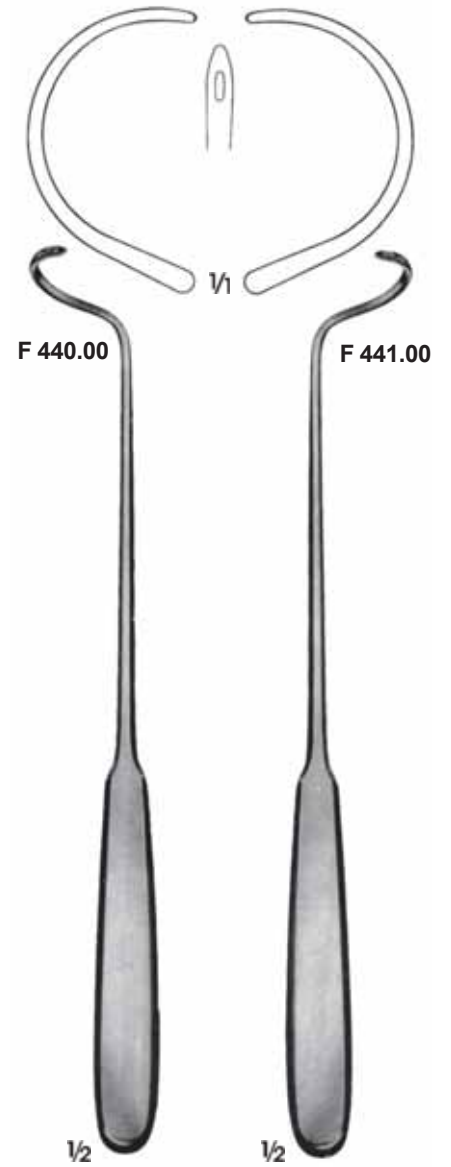

DESCHAMPS
F 440.00 Sağ/Right
F 441.00 Sol/Left
Künt/Blunt
24 cm



1/2

BRUNNER
F 465.00 - F 465.01
30 cm



1/2

BRUNNER
F 466.00 - F 466.01
30 cm



KOENIG
F 481.00
19.5 cm



KOENIG
F 482.00
20 cm



SCHMIEDEN
F 483.00
18.5 cm



PAYR
F 484.00
19.5 cm

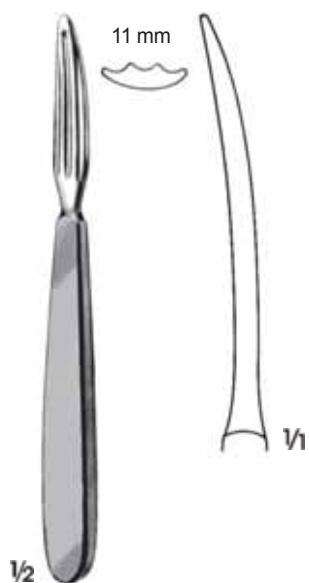

KOCHER
F 488.00
15 cm



KOCHER
F 489.00
17 cm



PAYR
F 485.00
22.5 cm



J 010.00 13 cm
J 010.01 14.5 cm
J 010.02 16 cm



DOYEN
J 012.00
14.5 cm



J 015.00
14 cm



J 030.00 13 cm
J 030.01 14.5 cm
J 030.02 16 cm
J 030.03 18 cm
J 030.04 20 cm



J 031.00
14.5 cm



Uc çapı Diameter of tips	1.5 mm	2 mm	Uzunluk Lenght
1 mm	J 033.07	-	13 cm
-	J 033.08	J 033.15	14.5 cm
J 033.01	J 033.09	J 033.16	16 cm
-	J 033.10	J 033.17	18 cm
-	J 033.11	J 033.18	20 cm
-	J 033.12	-	25 cm
-	-	J 033.20	30 cm
-	-	-	-

J 033.01 - J 033.20



J 035.00 14.5 cm
J 035.01 16 cm
J 035.02 20 cm



J 038.00 25 cm
J 038.01 30 cm
Bükülebilir / Malleable

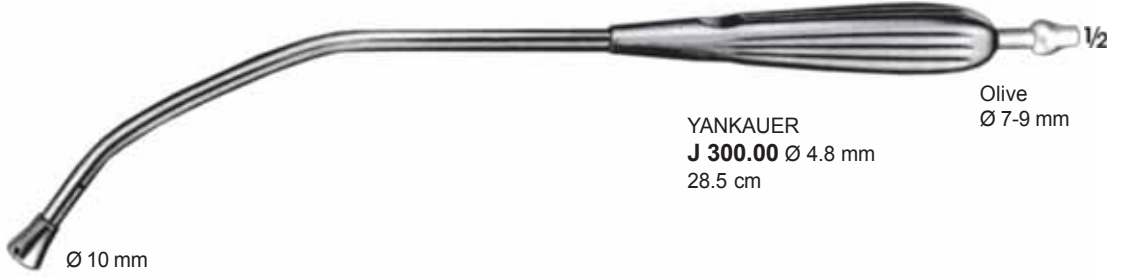
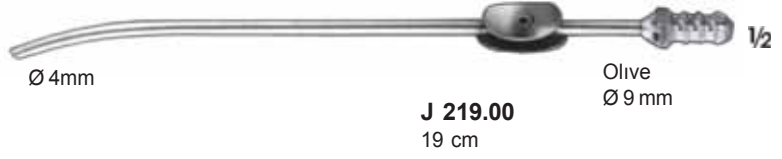



TONNIS
K 137.00
15 cm



KILNER
K 127.00
16 cm

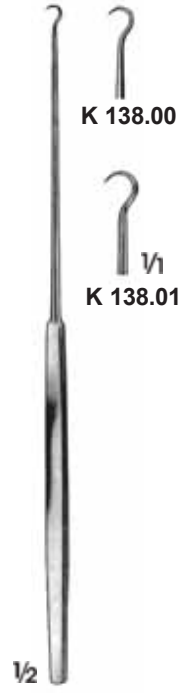

GILLIES
K 138.00 - K 138.01
18 cm



CUSHING
K 104.00
19 cm



SIMON
K 221.00
22 cm



SIMON
K 223.00
22 cm

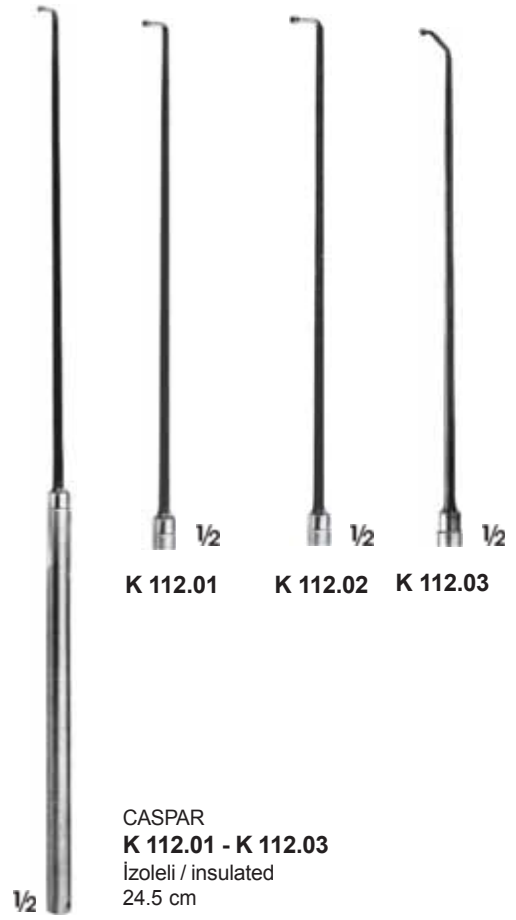

K 112.01 **K 112.02** **K 112.03**

CASPAR
K 112.01 - K 112.03
İzoleli / insulated
24.5 cm

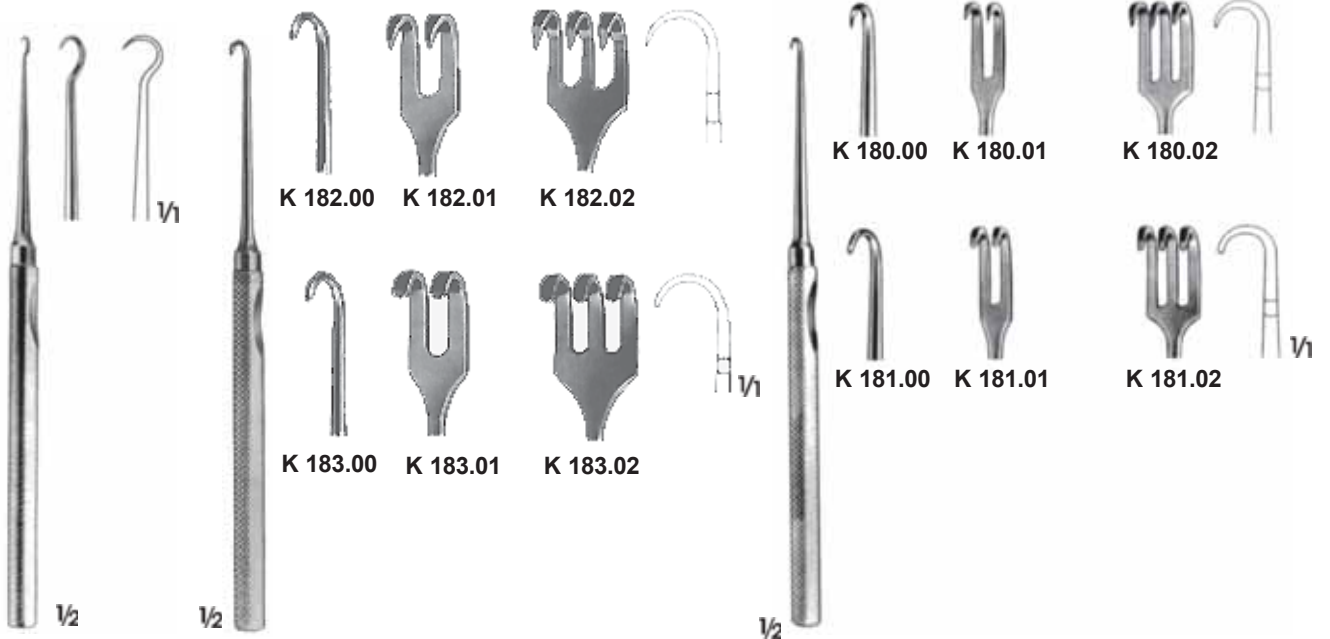

MANNERFELT
K 176.00
Sivri/Sharp
15.5 cm

MANNERFELT
K 182.00 - K 182.02 Sivri/Sharp
K 183.00 - K 183.02 Künt/Blunt
Büyük / Large
15.5 cm

MANNERFELT
K 180.00 - K 180.02 Sivri/Sharp
K 181.00 - K 181.02 Künt/Blunt
Küçük/Small
15.5 cm

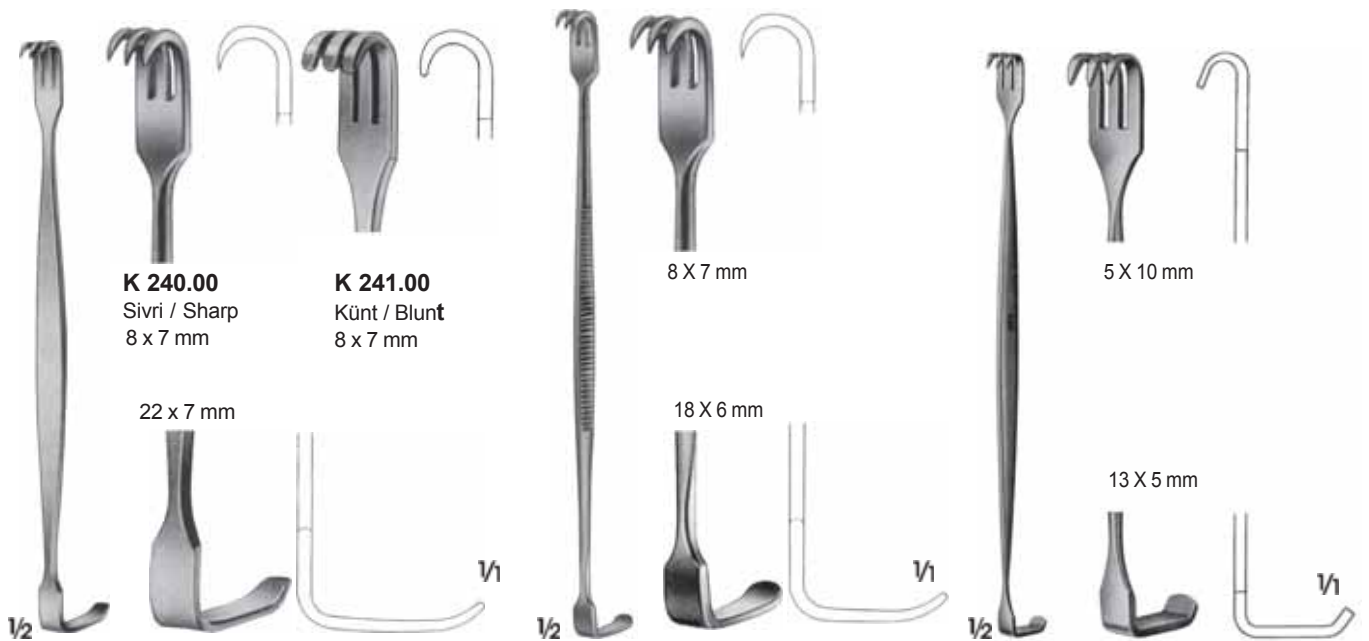

K 240.00
Sivri / Sharp
8 x 7 mm

K 241.00
Künt / Blunt
8 x 7 mm

8 X 7 mm

5 X 10 mm

22 x 7 mm

18 X 6 mm

13 X 5 mm

BABY - SENN - MILLER
K 240.00-K 241.00
15.5 cm

SENN-MILLER
K 242.00
16.5 cm

KILNER
K 237.00
15.5 cm

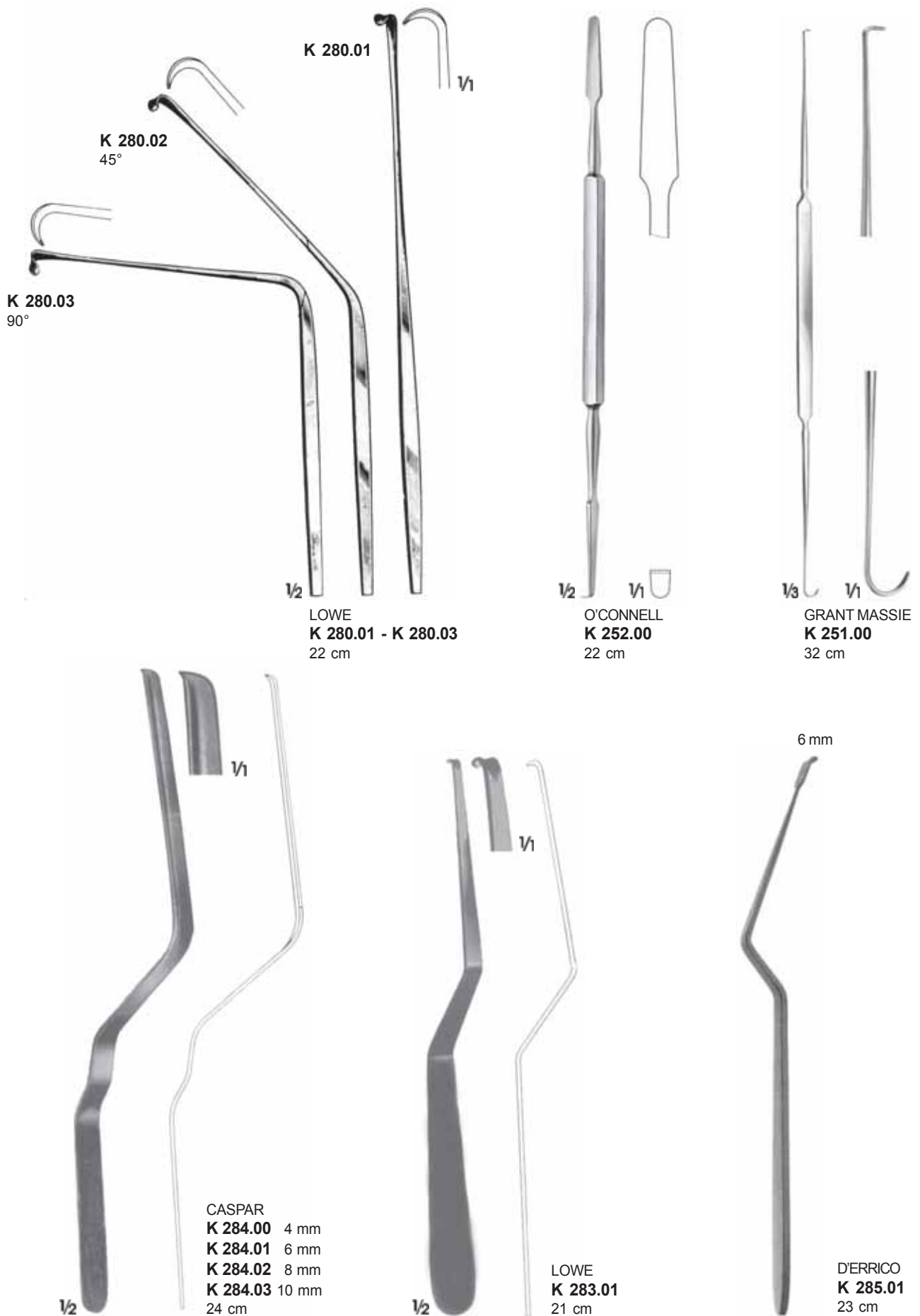

5 X 3 mm



RAGNELL
K 235.00
15 cm

14 X 6.3 mm



K 232.00
18 cm



1/2

MANNERFELT
K 195.00 - K 195.02
15.5 cm



K 195.00
12 x 12 mm



K 195.01
12 x 14 mm



K 195.02
14 x 16 mm



1/2

KOCHER
K 276.00 - K 276.01
20.5 cm



K 276.01
20 x 15 mm



K 276.00
20 x 12 mm



K 263.01
14 x 18 mm



1/2

CUSHING
K 263.00-K 263.01
20.5 cm



K 263.00
10 x 13 mm



1/2

CUSHING
K 274.00 - K 274.02
25 cm



K 274.02
15 x 22 mm



K 274.01
13 x 18 mm



K 274.00
11 x 14 mm

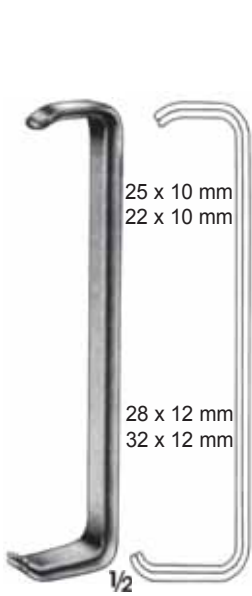

FARABEU F
K 310.00
12.5 cm



FARABEU F
K 311.00
15 cm

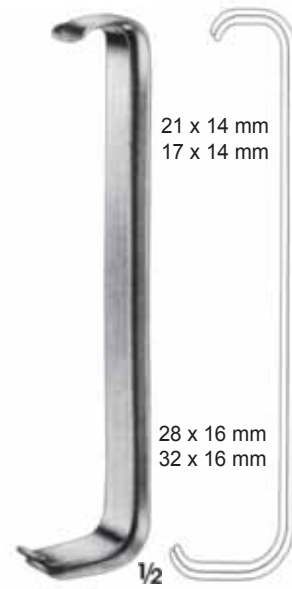

COLLIN
K 312.00
15 cm



PARKER
K 314.00
13.5 cm

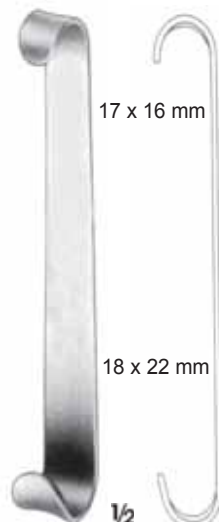

BABY-ROUX
K 315.00
13.5 cm



KILNER
K 322.01
15 cm



ROUX
K 320.00
15 cm



ROUX
K 320.01
16 cm

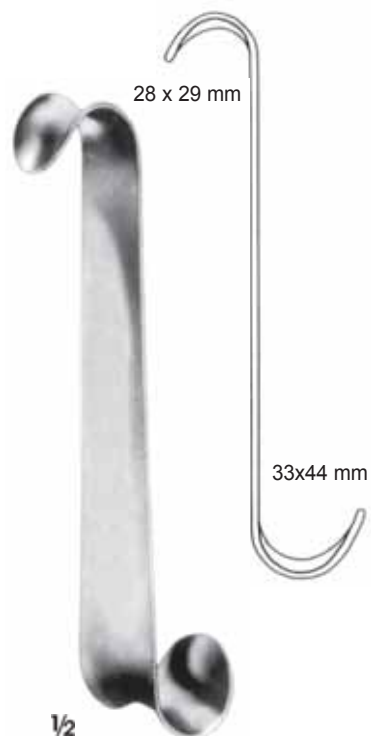

ROUX
K 320.02
17 cm

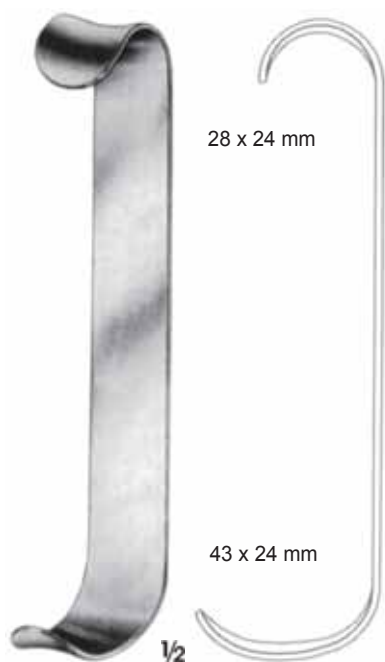

ROUX
K 327.00
17 cm



KILNER
K 333.00
15 cm



ROUX
K 327.01
19 cm



ROUX
K 325.00
Komple/Complete
16.5 cm
K 325.01 - K 325.03



23 x 30 mm
K 325.01



28 x 38 mm
K 325.02



33 x 45 mm
K 325.03

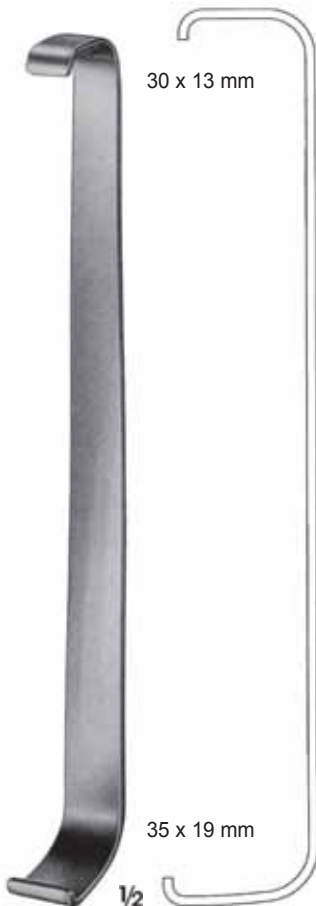

35 x 19 mm
**LANE
K 328.00**
23 cm



35 x 32 mm
**LANE
K 329.00**
23 cm

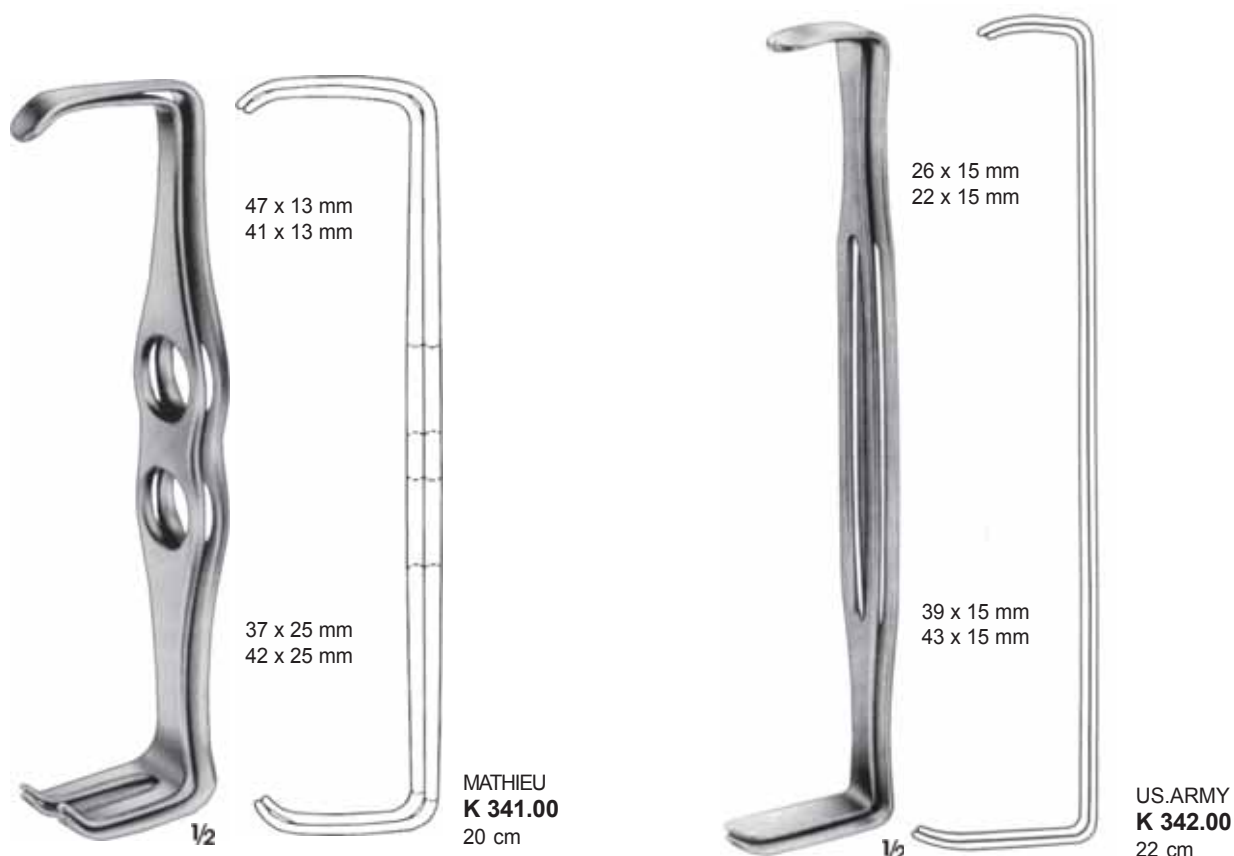
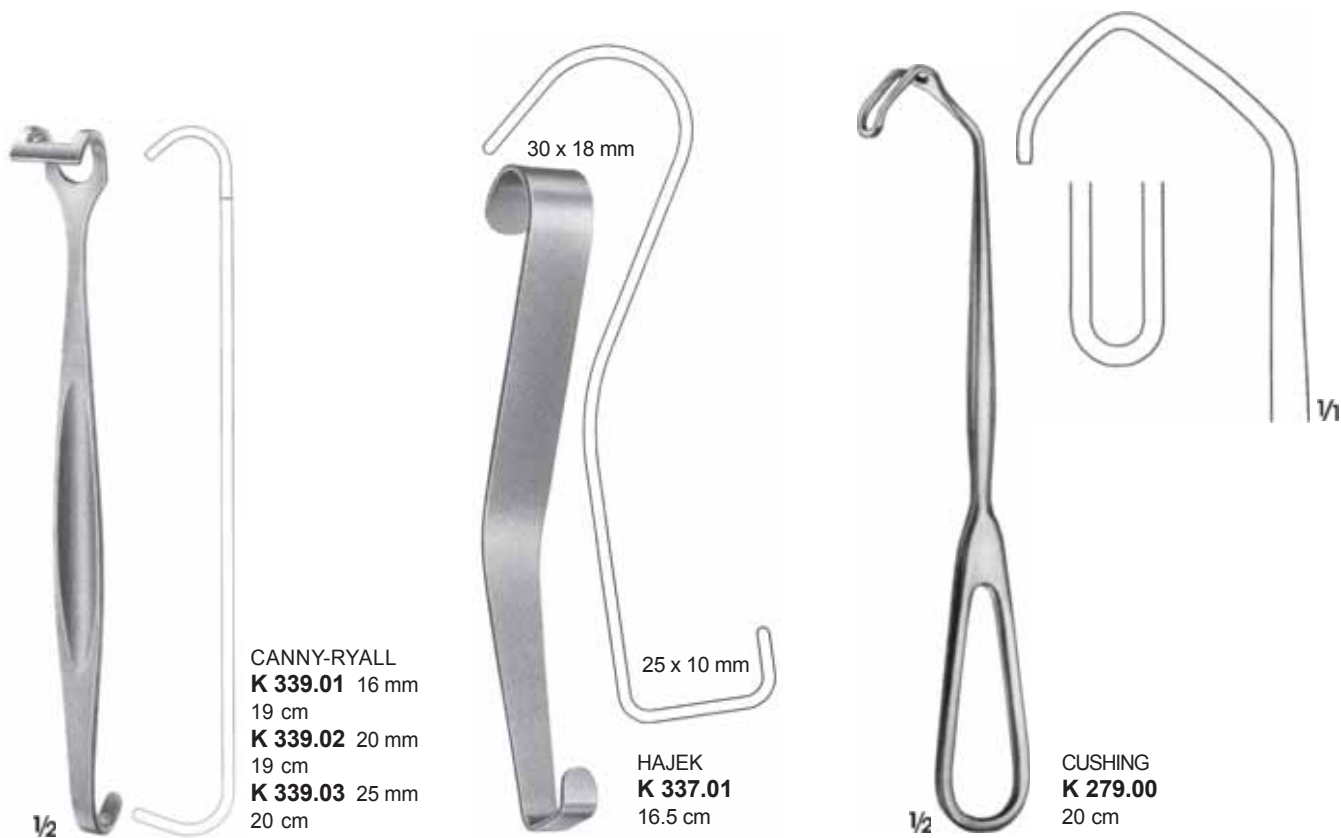



KOCHER
K 400.00
Sivri/Sharp
20.5 cm



KOCHER
K 401.00
Kunt/Blunt
20.5 cm



KOCHER
K 402.00
Sivri/Sharp
22 cm



KOCHER
K 403.00
Kunt/Blunt
22 cm



VOLKMANN
K 404.00
Sivri/Sharp
22 cm



VOLKMANN
K 405.00
Kunt/Blunt
22 cm



K 406.00
Sivri/Sharp
20 cm



K 407.00
Kunt/Blunt
20 cm



K 408.00
Sivri/Sharp
24.5 cm



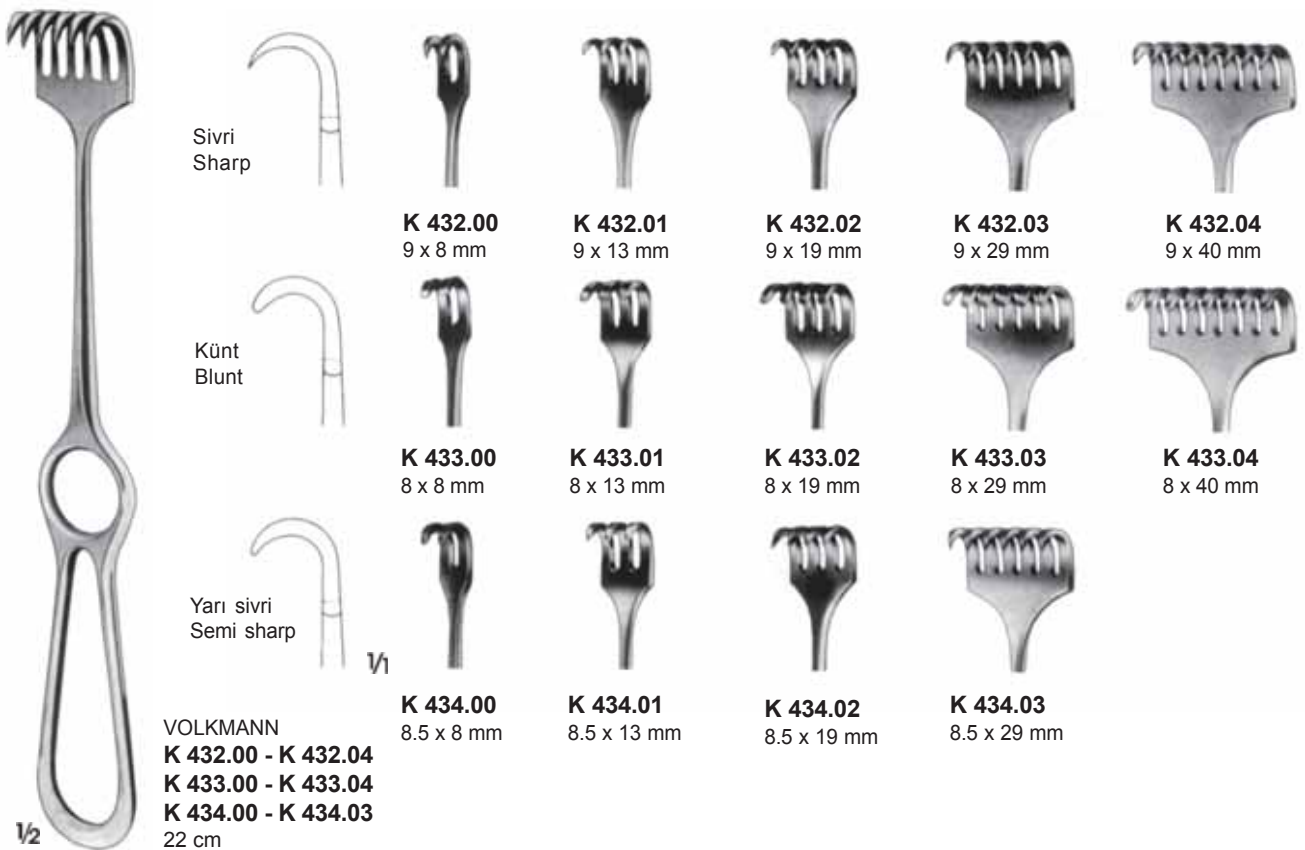
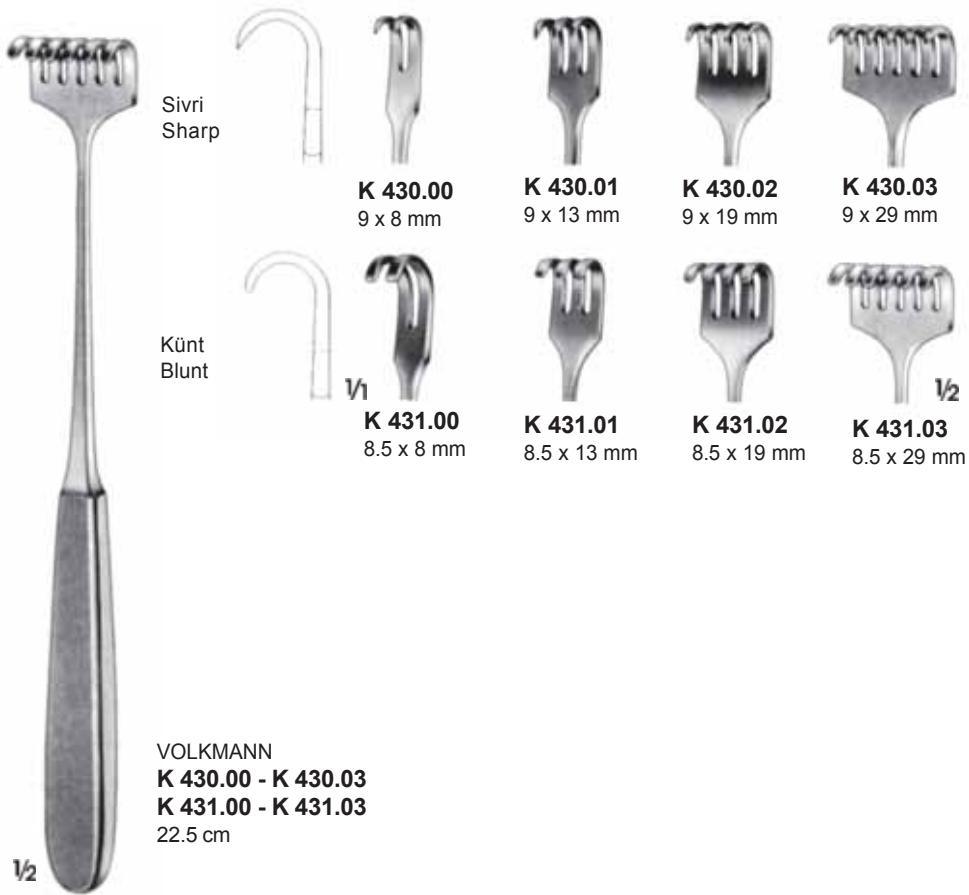



1/2

KOCHER
K 435.00 - K 435.03
K 436.00 - K 436.03
22 cm



Yarı sivri
Semi sharp



Künt
Blunt



K 435.00
16 x 9 mm



K 435.01
16 x 14 mm



K 435.02
16 x 20 mm



K 435.03
16 x 30 mm



K 436.00
15.5 x 9 mm



K 436.01
15.5 x 14 mm



K 436.02
15.5 x 20 mm



K 436.03
15.5 x 30 mm



1/2

KÖRTE
K 437.00 - K 438.00
24 cm



26.5 x 40 mm

K 437.00
Sivri/Sharp



26 x 40 mm

K 438.00
Künt/Blunt



1/2

KÖRTE - WAGNER
K 439.00
Yarı sivri/Semi sharp
28 cm

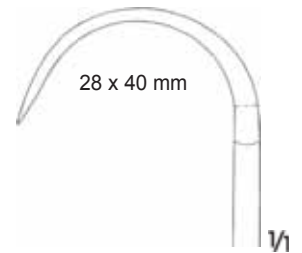

28 x 40 mm

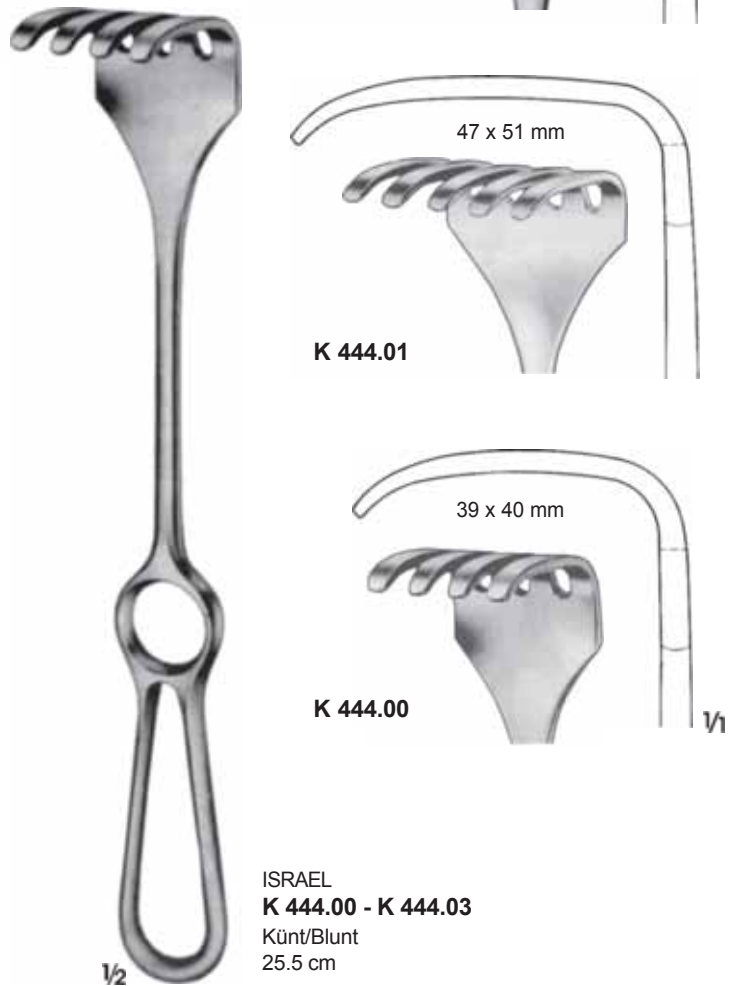
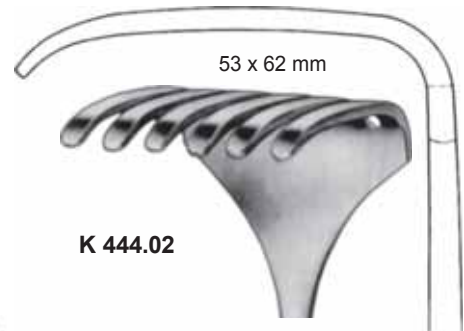
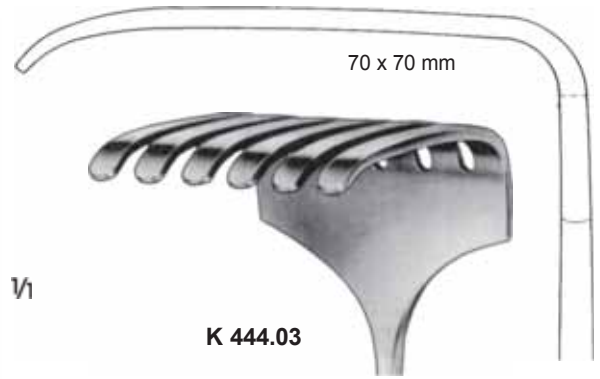
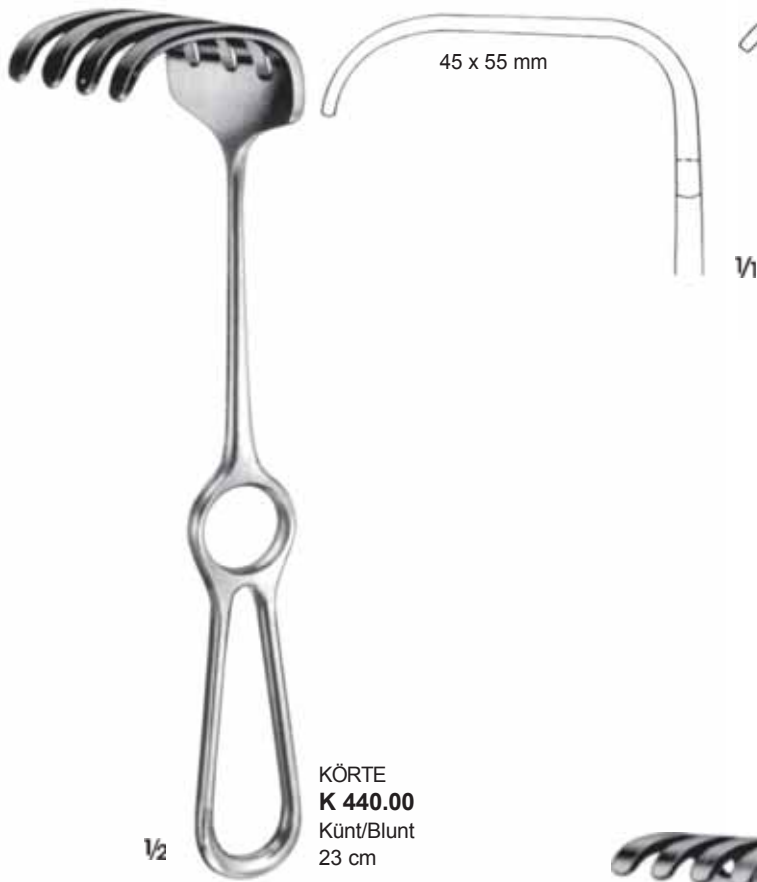

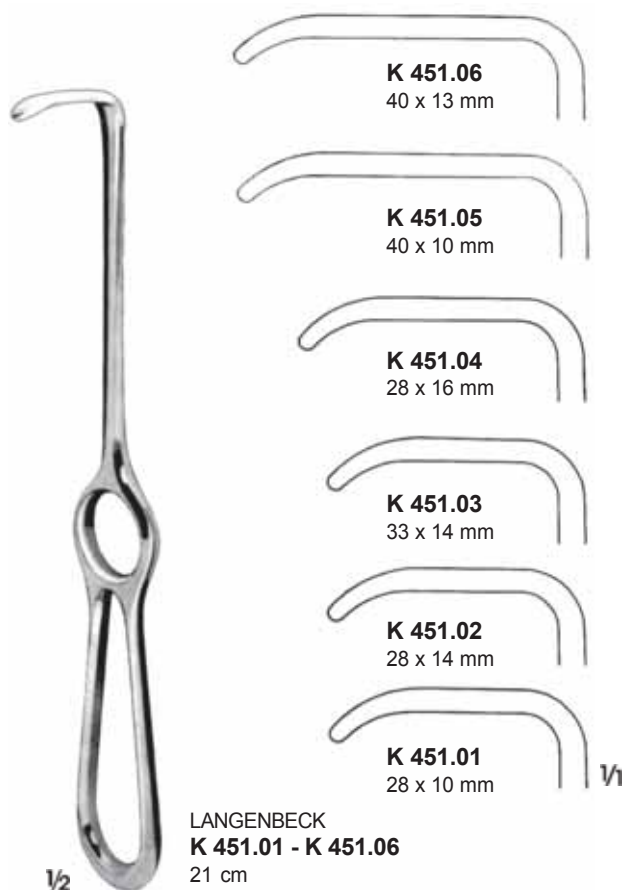
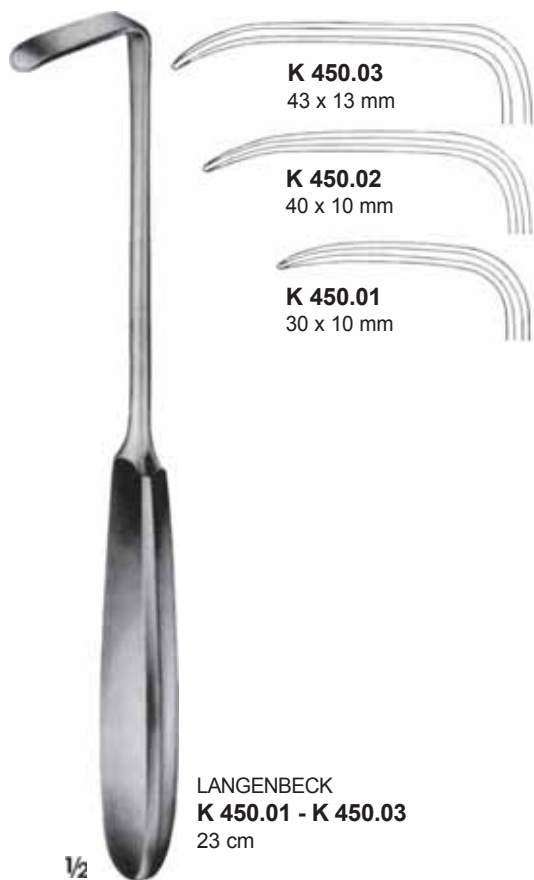

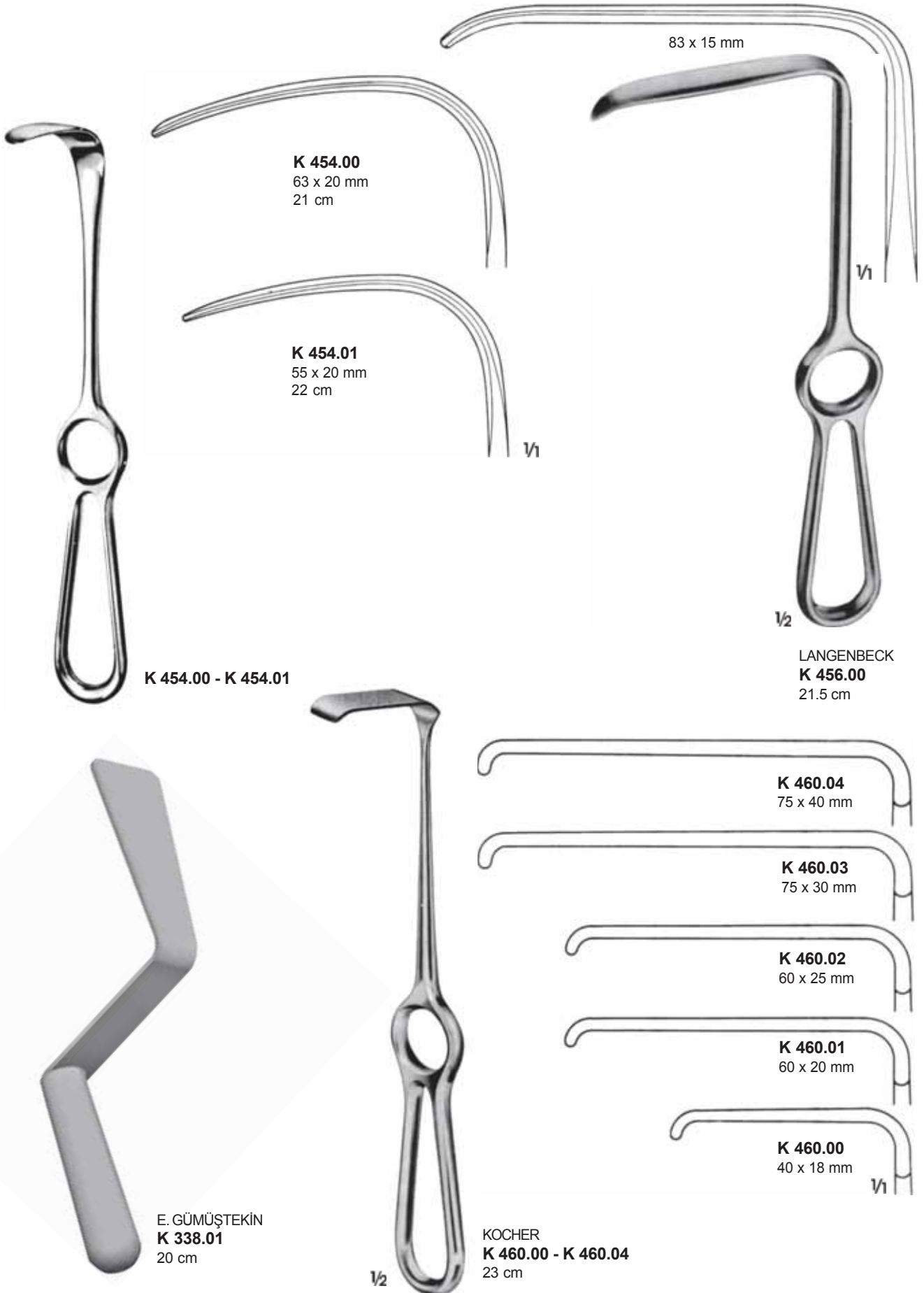



MIDDELDORPF
K 480.00 - K 480.02



K 480.02
28 x 28 mm
23.5 cm



K 480.01
20 x 22 mm
21.5 cm



K 480.00
15 x 15 mm
22 cm



GREENE
K 481.00
22.5 cm



28 x 20 mm



67 x 17 mm



1/2

CASPAR
K 601.00
21 cm



1/2



K 602.01
55 x 14 mm

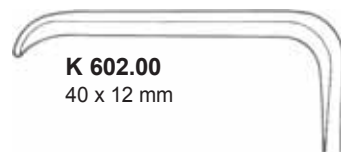

K 602.00
40 x 12 mm

DOCKHORN
K 602.00 - K 602.01
21 cm



KOCHER
K 605.01 - K 605.06

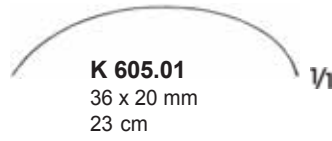

K 605.01
36 x 20 mm
23 cm



K 605.02
67 x 25 mm
25 cm

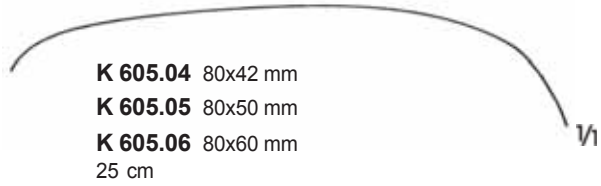

K 605.04 80x42 mm
K 605.05 80x50 mm
K 605.06 80x60 mm
25 cm



K 607.02
89 x 50 mm
25.5 cm



MEYERDING
K 607.00 - K 607.02



K 607.01
76 x 25 mm
23 cm



K 607.00
52 x 16 mm
21 cm



K 608.03
94 x36 mm



K 608.02
64 x25 mm



K 608.01
36 x20 mm



K 608.00
20 x15 mm

KOCHER - WAGNER
K 608.00 - K 608.03
28 cm

1/2



WEITLANER
L 300.00 Sivri/Sharp
11 cm



WEITLANER
L 301.00 Künt/Blunt
11 cm



WEITLANER
L 302.00 Yarı Sivri/Semi Sharp
11 cm



WEITLANER
L 304.00 Sivri/Sharp
13 cm



WEITLANER
L 305.00 Künt/Blunt
13 cm



WEITLANER
L 306.00 Yarı sivri/Semi sharp
13 cm



WEITLANER
L 308.00 Sivri/Sharp
13 cm



WEITLANER
L 309.00 Künt/Blunt
13 cm



MOLLISON
L 340.00 Sivri/Sharp
14 cm



CAIRNS
L 333.00 Sivri/Sharp
Dönebilen Bleyd/Swivel Blade
14.5 cm



JEFFERSON
L 327.00 Künt/Blunt
Eğri/Curved
14 cm



WEITLANER
L 312.00 Sivri/Sharp
16.5 cm



WEITLANER
L 313.00 Künt/Blunt
16.5 cm



RINTNE
L 328.00 Sivri/Sharp
16.5 cm



HENDERSON
L 329.00 Sivri/Sharp
17 cm

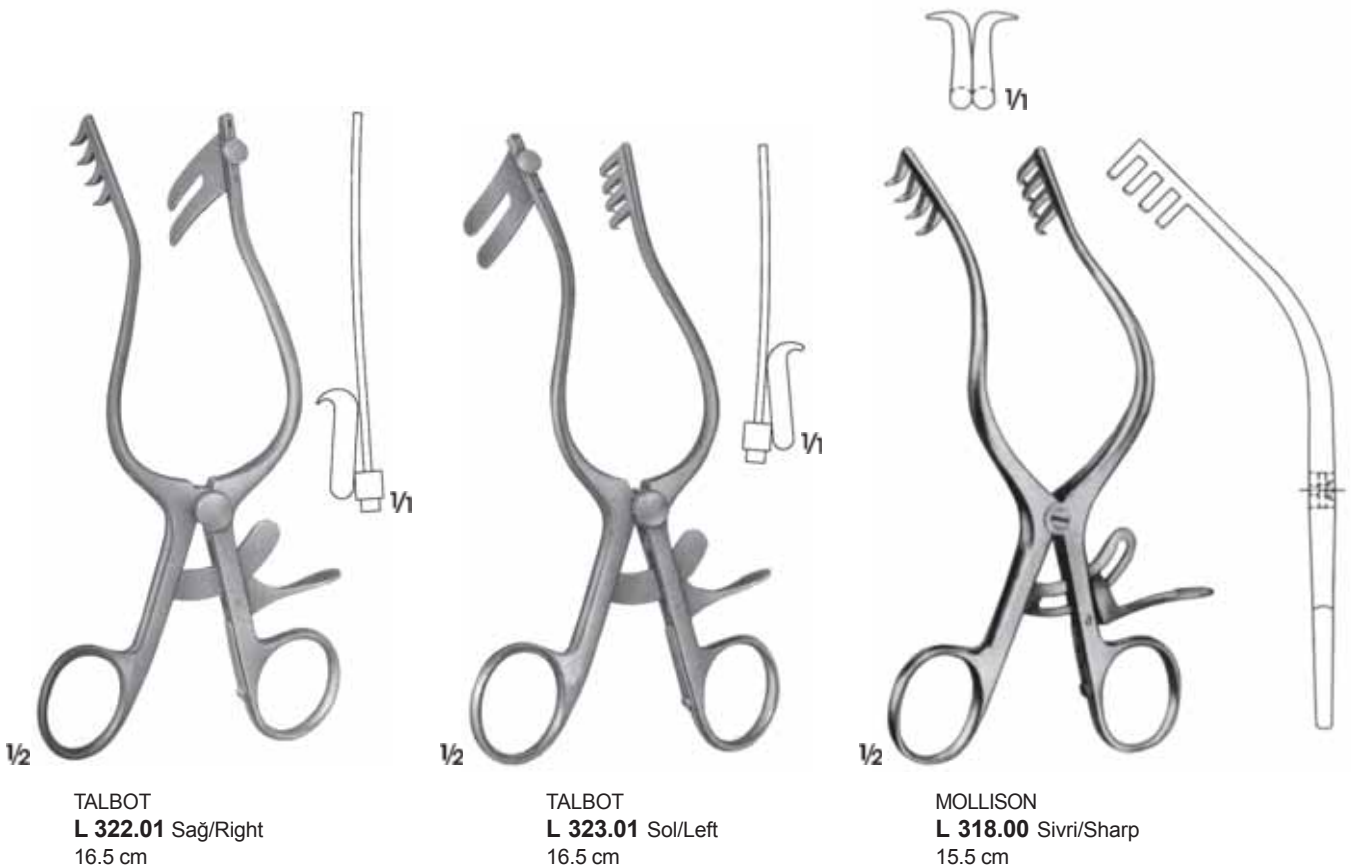
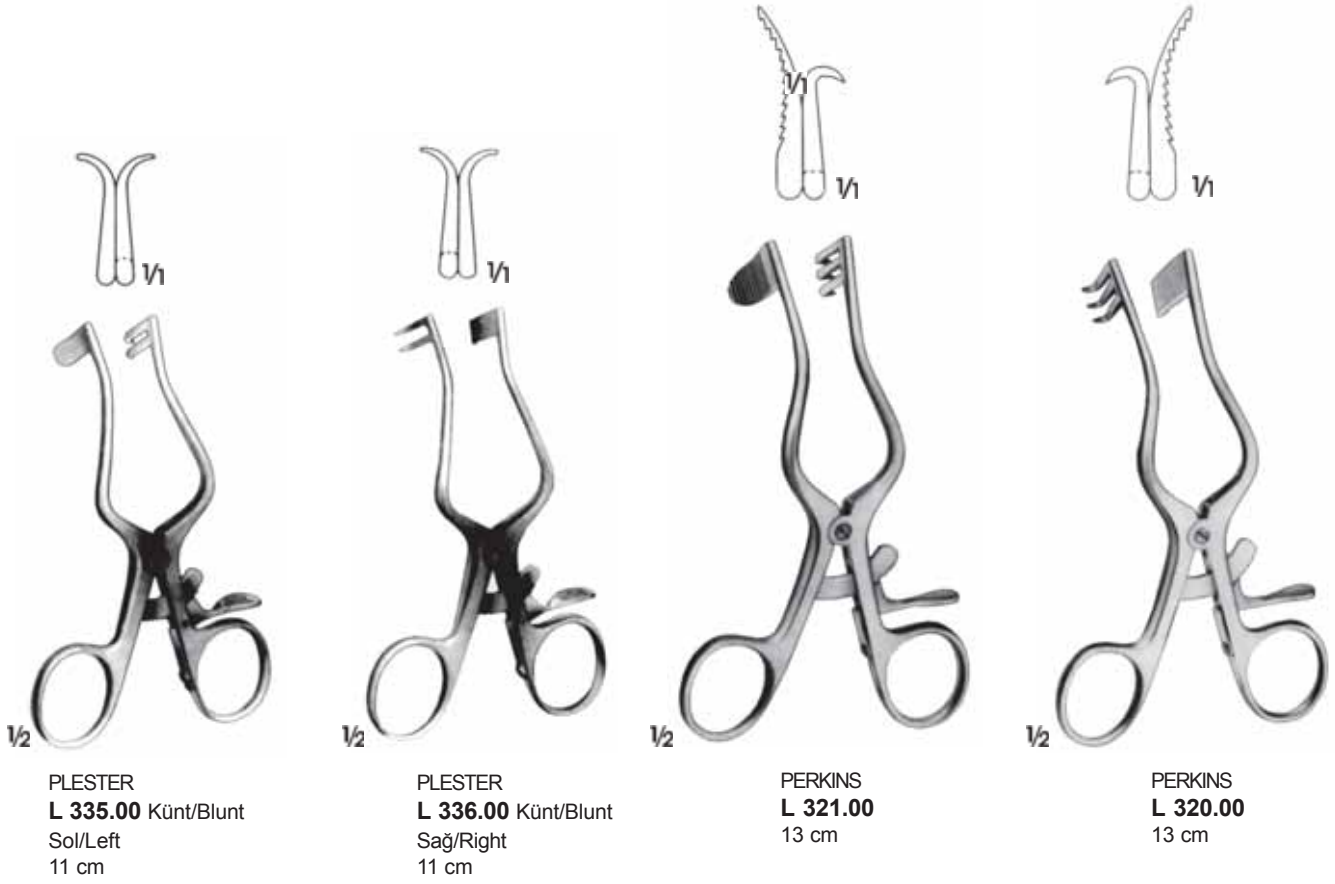



1/2

ADSON - BABY
L 330.02 Sivri/Sharp
L 331.02 Künt/Blunt
14 cm



1/2

ADSON
L 330.04 Sivri/Sharp
L 331.04 Künt/Blunt
16 cm



1/2

ADSON
L 330.06 Sivri/Sharp
L 331.06 Künt/Blunt
20 cm



1/2

WULLSTEIN
L 325.00 Sivri/Sharp
13 cm

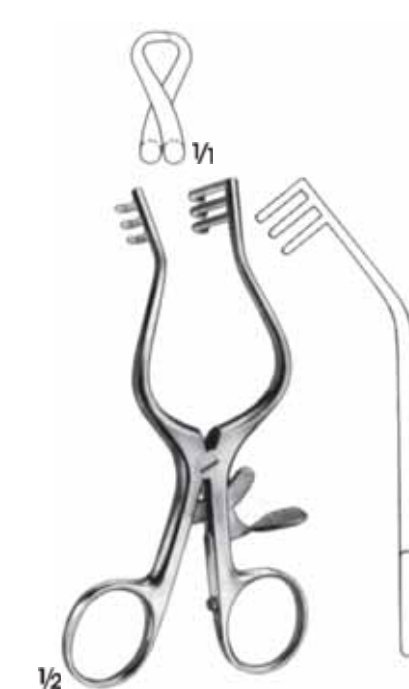

1/2

WULLSTEIN
L 326.00 Künt/Blunt
13 cm



1/2

PLESTER
L 338.00
Sivri/Sharp
13 cm



PLESTER
L 339.00
Künt/Blunt
13 cm



CLOWARD
L 343.00 Künt/Blunt
L 344.00 Sivri/Sharp
14 cm



TÜBINGER
L 345.00
16.5 cm



MAYO - ADAMS
L 348.00
16.5 cm



WEITLANER
L 314.00 Yarı sivri/Semi sharp
16.5 cm



WEITLANER
L 350.00 Sivri/Sharp
L 351.00 Künt/Blunt
18 cm

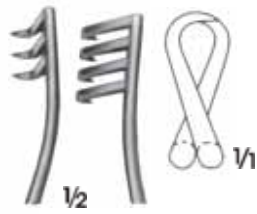

L 353.01 Sivri/Sharp
19.5 cm

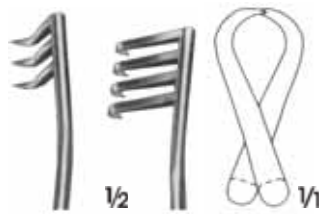

L 353.02 Sivri/Sharp
24 cm

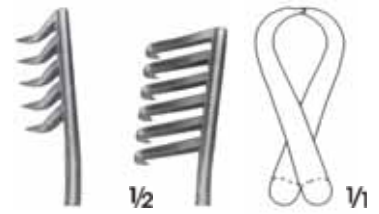

L 353.03 Sivri/Sharp
25.5 cm

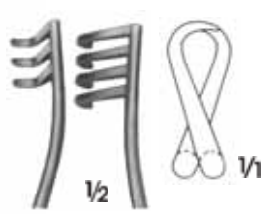

L 354.01 Künt/Blunt
19.5 cm

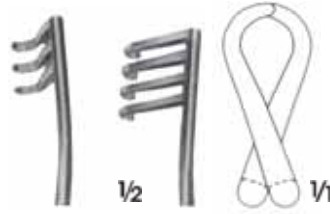

L 354.02 Künt/Blunt
24 cm



L 354.03 Künt/Blunt
25.5 cm

WEITLANER
L 353.01 - L 353.03
L 354.01 - L 354.03

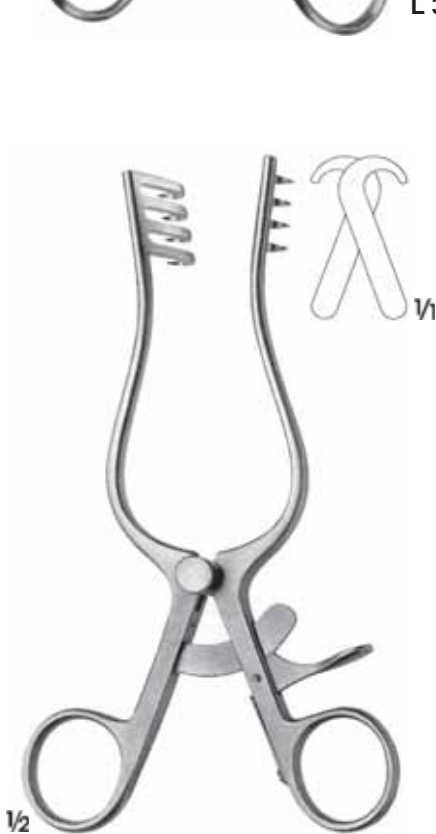

IRWIN
L 347.00 Sivri/Sharp
17.5 cm



ANDERSON - ADSON
L 356.00 Sivri/Sharp
19 cm

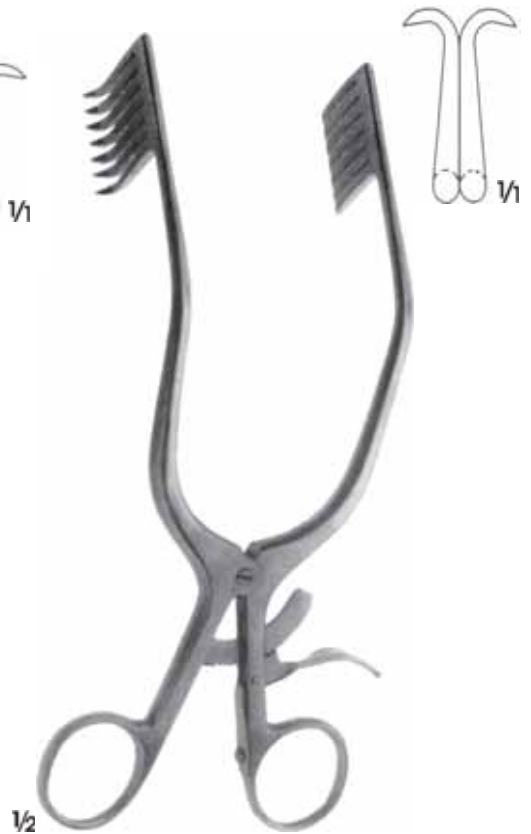

MISKIMON
L 360.00 Sivri/Sharp
19 cm



NORFOLK NORWICH
L 362.00 Kunt/Blunt
22 cm



ADSON
L 364.00 Sivri/Sharp
26.5 cm



ADSON
L 365.01 Sivri/Sharp
26 cm

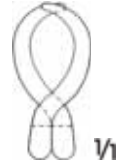
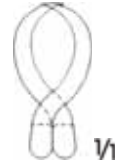
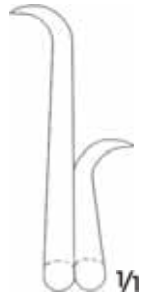

L 366.02 Sivri/Sharp
28 cm



L 368.02
Sivri/Sharp
28 cm



BECKMANN - ADSON
L 370.02 Sivri/Sharp
31 cm



BECKMANN - ADSON
L 371.02
Yarı Sivri/Semi Sharp
31 cm



ADSON
L 375.02 Yarı Sivri/Semi Sharp
32 cm



BECKMANN - EATON
L 377.02 Sivri/ Sharp
32 cm



BECKMANN-ADSON
L 378.01
Derinlik/Depth 45 mm
Künt/Blunt
L 379.01
Derinlik/Depth 25 mm
Sivri/Sharp
29 cm

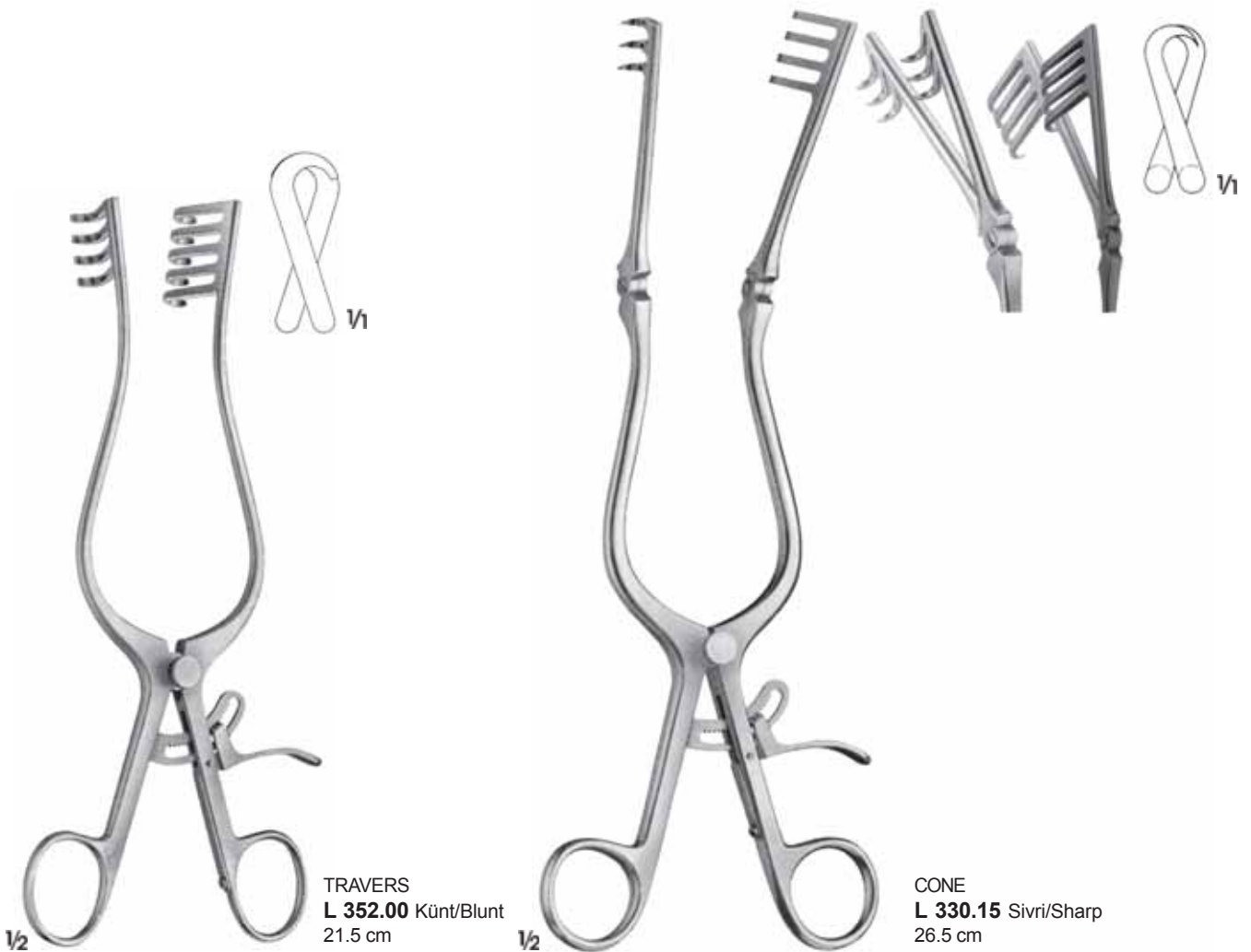
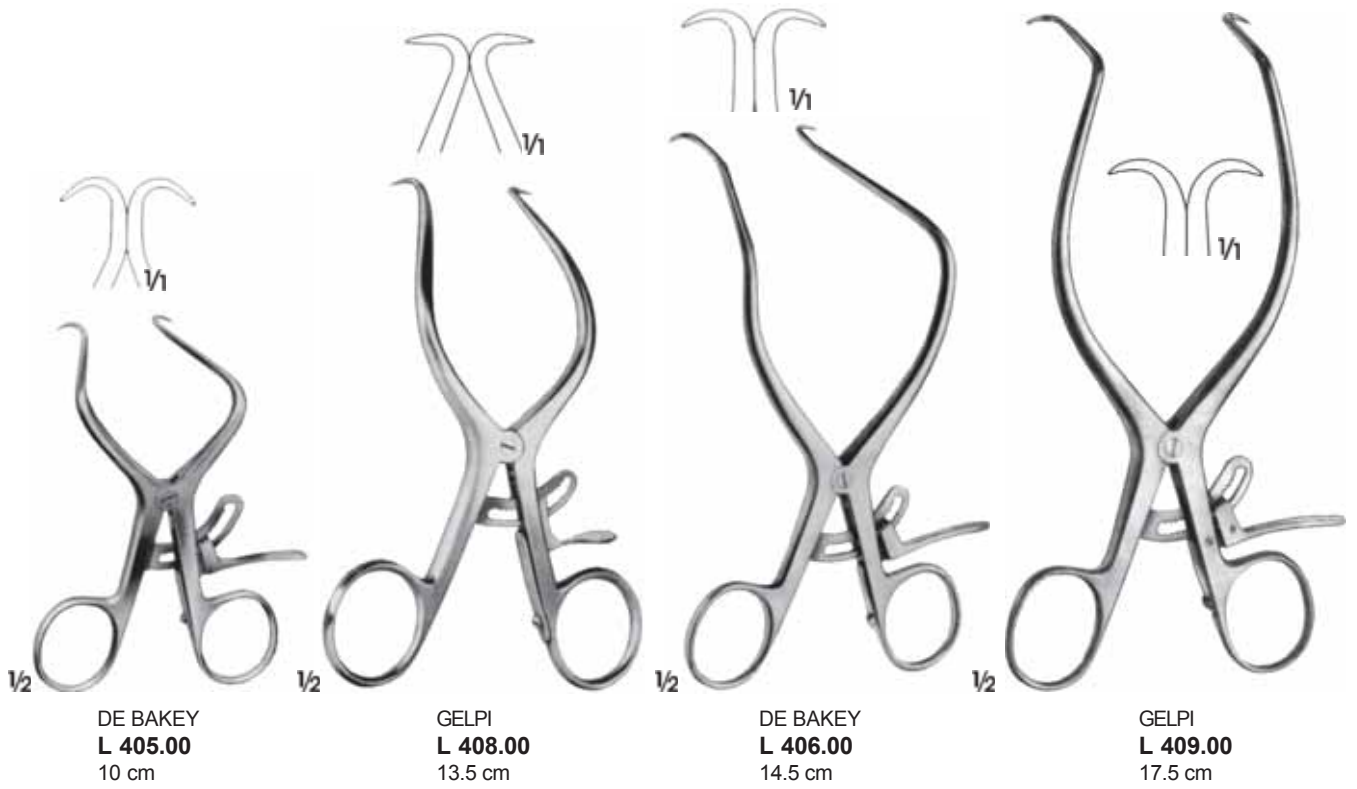



MEYERDING
L 380.01 - L 381.05
Sağ bleyd/Right blade
18 cm



MEYERDING
L 380.00 - L 381.04
Sol bleyd/Left blade
18 cm



L 381.00 Sol Bleyd
Left Blade
L 381.01 Sağ Bleyd
Right Blade

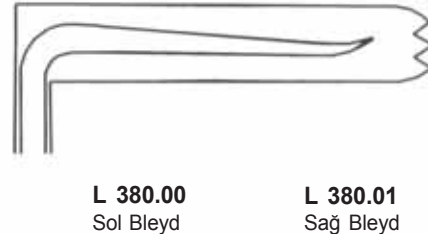

L 380.00 Sol Bleyd
Left Blade
L 380.01 Sağ Bleyd
Right Blade

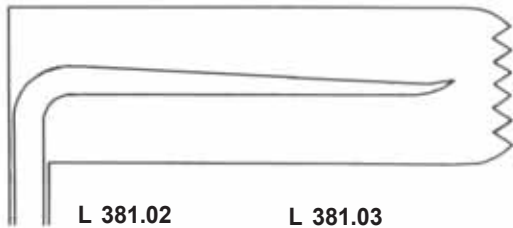

L 381.02 Sol Bleyd
Left Blade
L 381.03 Sağ Bleyd
Right Blade

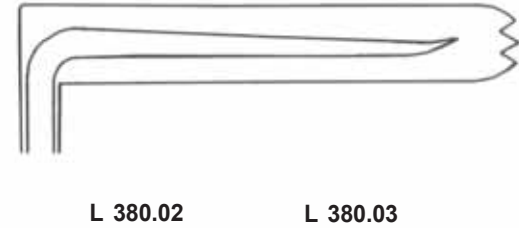

L 380.02 Sol Bleyd
Left Blade
L 380.03 Sağ Bleyd
Right Blade

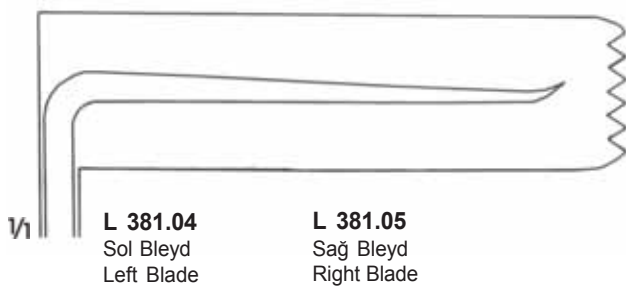

L 381.04 Sol Bleyd
Left Blade
L 381.05 Sağ Bleyd
Right Blade

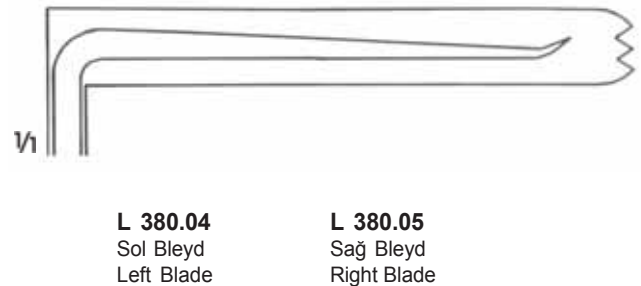

L 380.04 Sol Bleyd
Left Blade
L 380.05 Sağ Bleyd
Right Blade



DARLING
L 384.01
18 cm



DARLING
L 384.02
18 cm



MEYERDING
L 386.00 25 x 40 mm
L 386.01 25 x 50 mm
L 386.02 25 x 60 mm
17 cm



L 390.00
17 cm



L 392.00 Sağ/Right
18 cm



L 394.00 Sol/Left
18 cm



L 450.01
Sadece Ekartör
Retractor only



L 450.04 48 mm
L 450.06 60 mm



L 450.12 48 x 30 mm
L 450.14 60 x 30 mm



L 450.08 48 x 50 mm
L 450.10 60 x 50 mm



L 450.15 48 x 50 mm
L 450.16 60 x 50 mm



L 450.18 38 x 62 mm



L 450.20 28 x 40 mm

SCOVILLE - RICHTER
L 450.00 Komple / Complete
L 450.01
L 450.04 - L 450.06 - L 450.08
L 450.10 - L 450.12 - L 450.14



L 452.01
Sadece Ekartör
Retractor only



L 452.04 62 x 37mm



L 452.06 62 x 52mm



L 452.08 47 x 51mm



L 452.10 30 x 40 mm



L 452.12 37 x 62 mm

SCOVILLE - RICHTER
L 452.00
Komple / Complete
(L 452.04 - L 452.12)

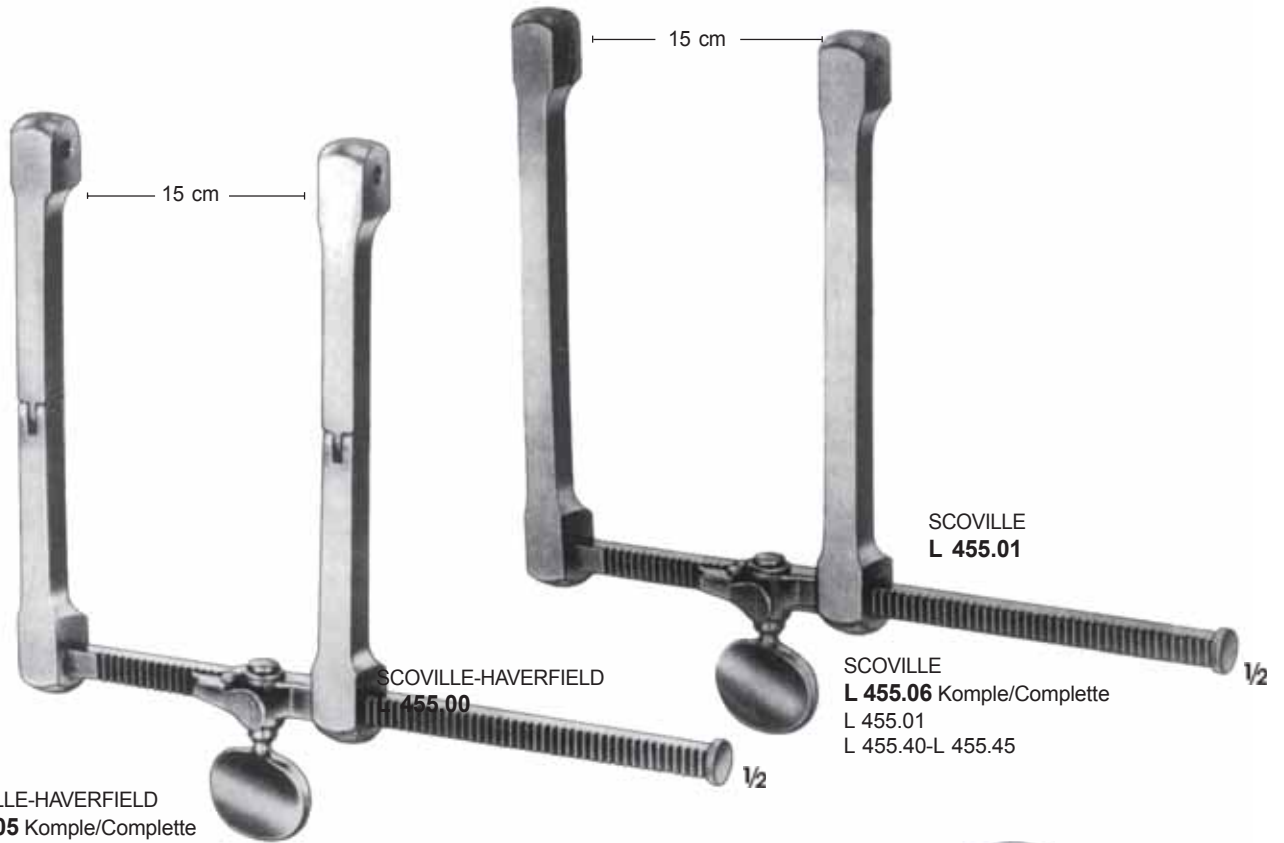

SCOVILLE-HAVERFIELD
L 455.05 Komple/Complete
L 455.00
L 455.40-L 455.45





L 460.01
Sadece Ekartör
Retractor only

CASPAR
L 460.00 Komple/Complete
L 460.01
L 463.02 - L 463.15 - L 463.25 - L 463.35

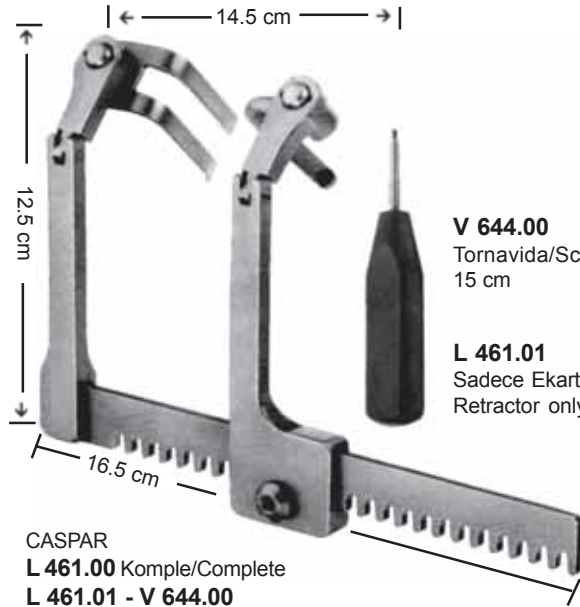

V 644.00
Tornavida/Screwdriver
15 cm

L 461.01
Sadece Ekartör
Retractor only

CASPAR
L 461.00 Komple/Complete
L 461.01 - V 644.00
L 463.02 - L 463.15 - L 463.25 - L 463.35



L 463.00 38 mm



L 463.02 58 mm



L 463.10 32 x 22 mm
L 463.11 37 x 22 mm
L 463.12 43 x 22 mm
L 463.13 47 x 22 mm
L 463.14 52 x 22 mm
L 463.15 57 x 22 mm
L 463.16 62 x 22 mm
L 463.17 67 x 22 mm



L 463.20 32 x 37 mm
L 463.21 37 x 37 mm
L 463.22 43 x 37 mm
L 463.23 47 x 37 mm
L 463.24 52 x 37 mm
L 463.25 57 x 37 mm
L 463.26 62 x 37 mm
L 463.27 67 x 37 mm



L 463.30 32 x 52 mm
L 463.31 37 x 52 mm
L 463.32 43 x 52 mm
L 463.33 47 x 52 mm
L 463.34 52 x 52 mm
L 463.35 57 x 52 mm
L 463.36 62 x 52 mm
L 463.37 67 x 52 mm

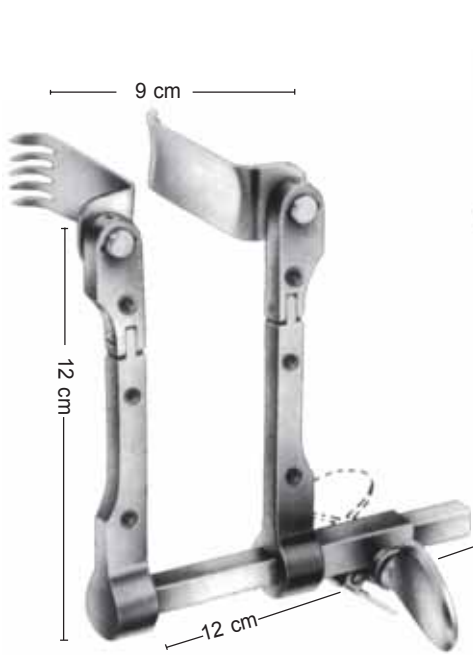

CASPAR
L 465.00
L 465.01 Sadece ekartör/Retractor only
(L 471.00 - L 471.04)



CASPAR
L 467.00
L 467.01 Sadece ekartör/Retractor only
(L 472.00 - L 472.05)



CASPAR
L 469.00
L 469.01 Sadece ekartör/Retractor only
(L 472.00 - L 472.05)



L 470.00 40 x 23 mm
L 470.01 45 x 23 mm
L 470.02 50 x 23 mm
L 470.03 55 x 23 mm
L 470.04 60 x 23 mm



L 471.00 40 x 23 mm
L 471.01 45 x 23 mm
L 471.02 50 x 23 mm
L 471.03 55 x 23 mm
L 471.04 60 x 23 mm



L 472.00 40 x 23 mm
L 472.01 45 x 23 mm
L 472.02 50 x 23 mm
L 472.03 55 x 23 mm
L 472.04 60 x 23 mm
L 472.05 65 x 23 mm



L 470.06 40 x 25 mm
L 470.07 45 x 25 mm
L 470.08 50 x 25 mm
L 470.09 55 x 25 mm
L 470.10 60 x 25 mm



L 471.06 40 x 25 mm
L 471.07 45 x 25 mm
L 471.08 50 x 25 mm
L 471.09 55 x 25 mm
L 471.10 60 x 25 mm



L 472.08 30 x 24 mm
L 472.09 35 x 24 mm
L 472.10 40 x 24 mm
L 472.11 45 x 24 mm
L 472.12 50 x 24 mm
L 472.13 55 x 24 mm
L 472.14 60 x 24 mm
L 472.15 65 x 24 mm
L 472.16 70 x 24 mm
L 472.17 75 x 24 mm

Titanium Bleyd
Titanium Blades



L 474.10 25 x 24 mm
L 474.11 30 x 24 mm
L 474.12 35 x 24 mm
L 474.13 40 x 24 mm
L 474.14 45 x 24 mm
L 474.15 50 x 24 mm
L 474.16 55 x 24 mm
L 474.17 60 x 24 mm
L 474.18 65 x 24 mm
L 474.19 70 x 24 mm
Titanium Bleyd
Titanium Blades



L 474.21 25 x 24 mm
L 474.22 30 x 24 mm
L 474.23 35 x 24 mm
L 474.24 40 x 24 mm
L 474.25 45 x 24 mm
L 474.26 50 x 24 mm
L 474.27 55 x 24 mm
L 474.28 60 x 24 mm
L 474.29 65 x 24 mm
L 474.30 70 x 24 mm
Titanium Bleyd
Titanium Blades



L 474.00 50 x 25 mm
L 474.01 60 x 25 mm



D 610.00
Bleyd tutma pensi
Blade Ejector forcep
11.5 cm



L 430.01
Sadece ekartör
Retractor only

VICKERS LOW-PROFILE
L 430.03 Komple/Complete
(L 430.01- L 430.10 - L 430.11)

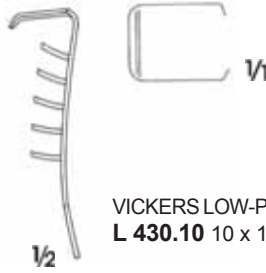

VICKERS LOW-PROFILE
L 430.10 10 x 12 mm

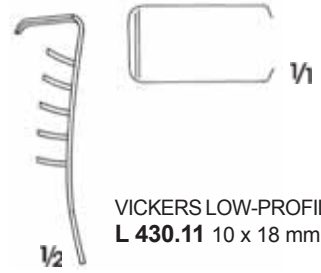

VICKERS LOW-PROFILE
L 430.11 10 x 18 mm



L 431.01
Sadece ekartör
Retractor only

VICKERS LOW-PROFILE
L 431.03 Komple/Complete
(L 431.01- L 430.10 - L 430.11)

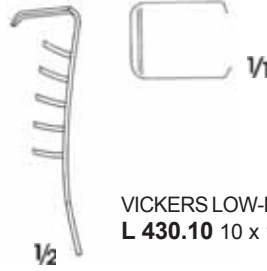

VICKERS LOW-PROFILE
L 430.10 10 x 12 mm

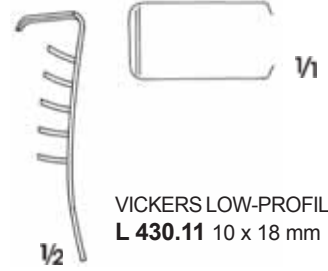

VICKERS LOW-PROFILE
L 430.11 10 x 18 mm



L 432.01
Sadece ekartör
Retractor only

VICKERS LOW-PROFILE
L 432.03 Komple/Complete
(L 432.01- L 430.10 - L 430.11)

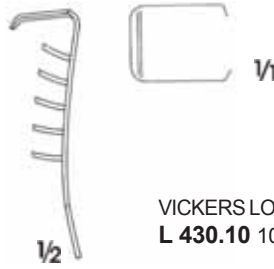

VICKERS LOW-PROFILE
L 430.10 10 x 12 mm

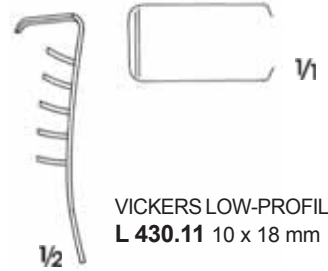

VICKERS LOW-PROFILE
L 430.11 10 x 18 mm



VICKERS
L 435.00
Parmak ekartörü/Finger Retractor
İnce deriler için uzun künt kancalar
Long blunt hooks for thin skin



CASPAR
L 486.02 - L 486.11



CASPAR
L 487.00 Komple/Complete
(L 487.05 - L 487.15)



CLOWARD
L 490.01
Sadece Ekartör/
Retractor only
25 cm

CLOWARD
L 490.00 Komple / Complete
L 490.01
L 490.05 - L 491.09



CLOWARD
L 491.00
Sadece Ekartör
Retractor only
15 cm

CLOWARD
L 491.01 Komple/Complete
L 491.00
L 491.05-L 491.06-L 491.07-L 491.08-L 491.09



L 490.09



L 490.08



L 490.07



L 490.06

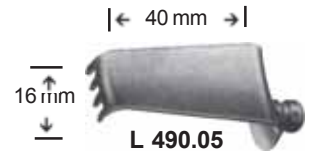

L 490.05



L 491.09



L 491.08



L 491.07



L 491.06



L 491.05



BALLANTINE
L 484.00 32 x 90 mm
23 cm

TAYLOR
L 482.00 32 x 75 mm
L 482.01 32 x 100 mm



1/2

CLOWARD
L 499.00
14 cm



1/2

CLOWARD
L 494.00
15.5 cm

5 mm



1/1



1/2

CLOWARD
L 495.00
13.5 cm

4.5 mm



1/1



1/2

INGE
L 497.00
17 cm

6 mm

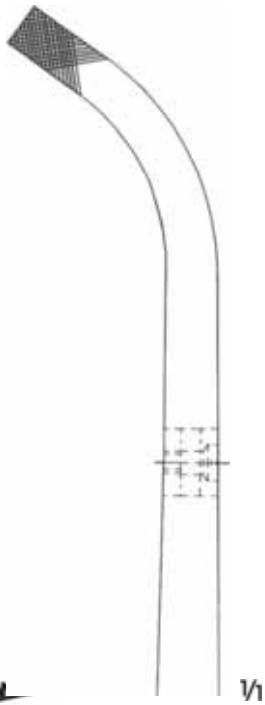

1/1

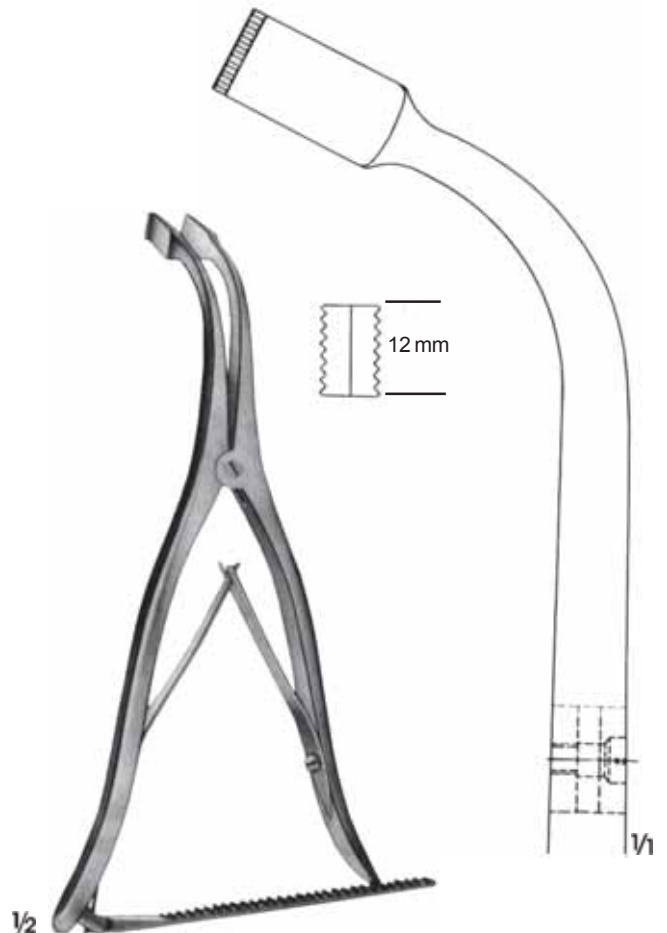

1/2

INGE
L 498.00
27.5 cm

12 mm



1/1

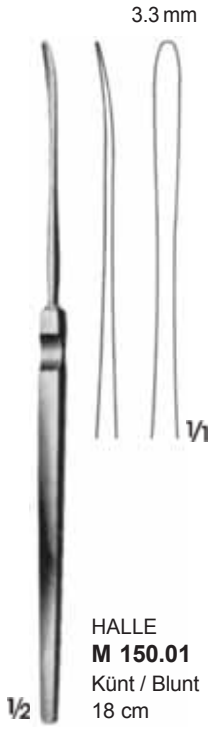

HALLE
M 150.01
Künt / Blunt
18 cm

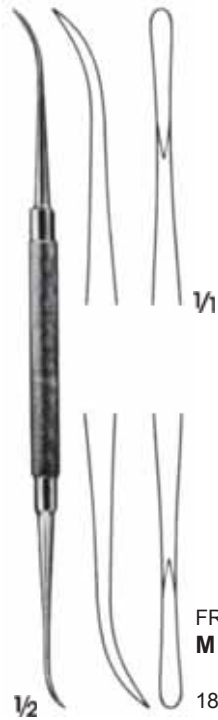

FREER - YASARGIL
M 162.01 Sivri / Sharp
Sivri / Sharp
18.5 cm



PENFIELD
M 154.01
20.5 cm



M 165.01
22 cm



SACHS
M 180.01
21 cm



DAVIS
M 159.01
24 cm



DAVIS
M 115.01
24.5 cm

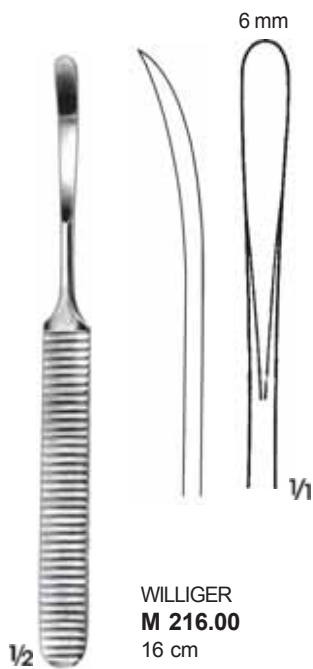
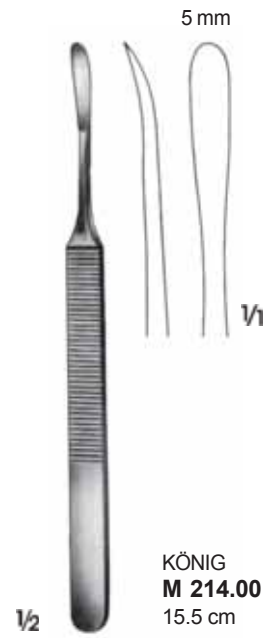
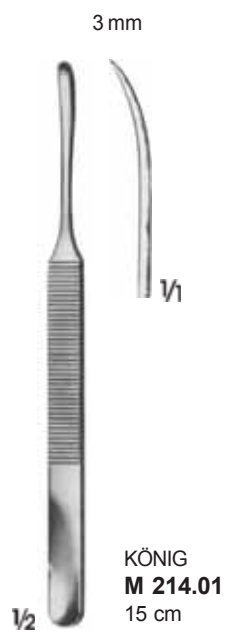

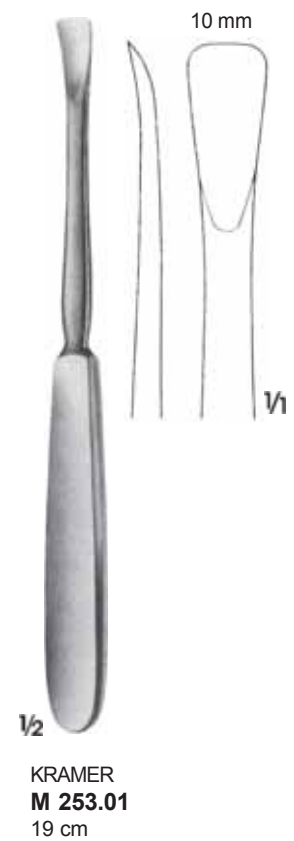
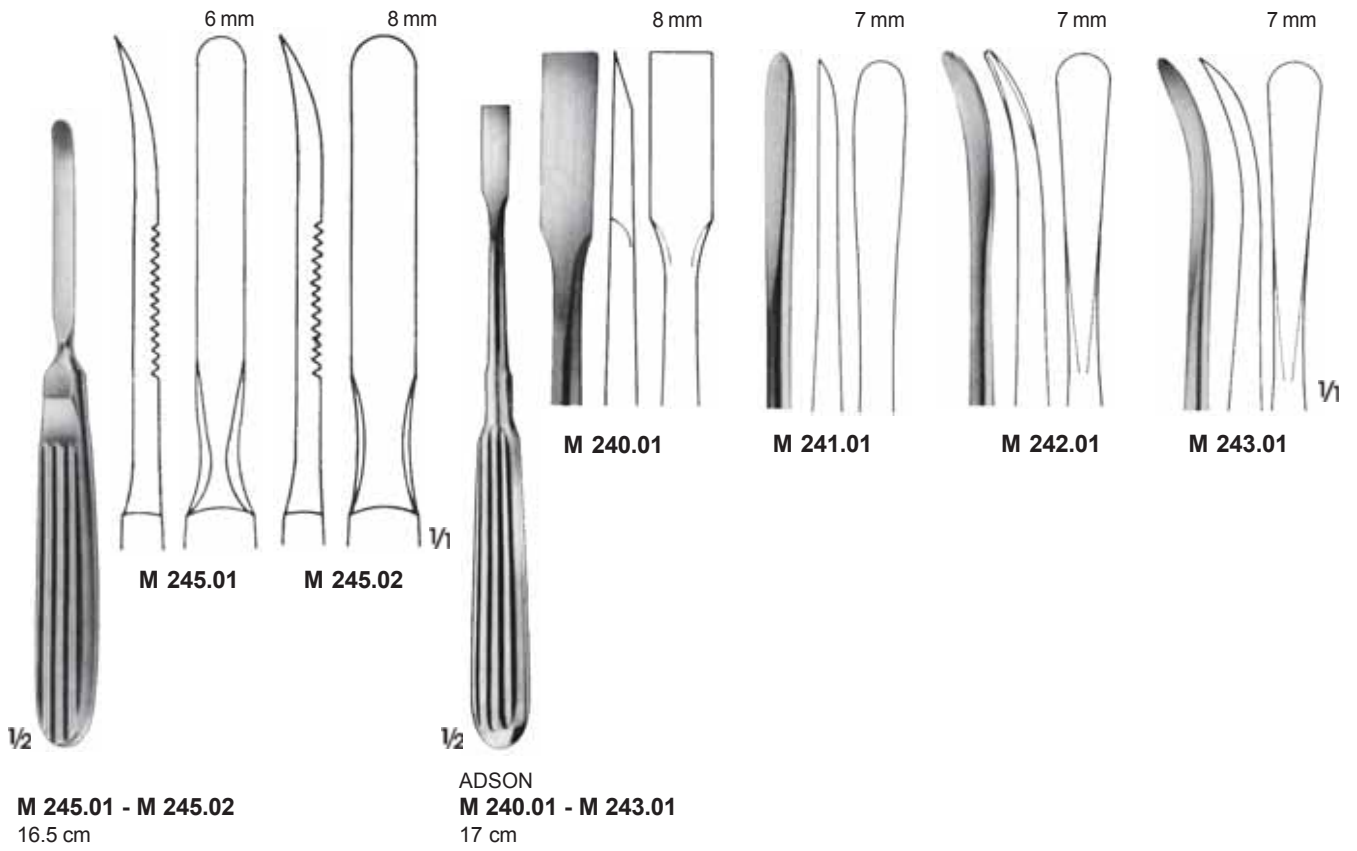



FARABEU
M 260.00
14 cm

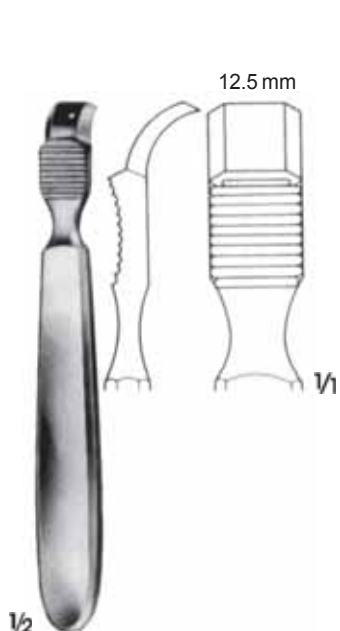

FARABEU
M 261.00
14 cm



FARABEU - COLLIN
M 263.00
16 cm



FARABEU - COLLIN
M 264.00
16 cm

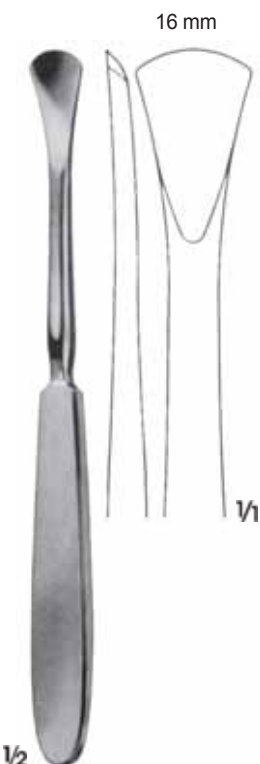

LANGENBECK
M 265.01
19 cm

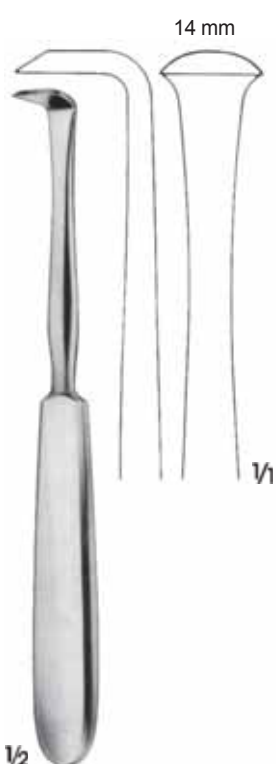

LANGENBECK
M 266.01
18 cm



SCHNEIDER
M 270.01
17.5 cm

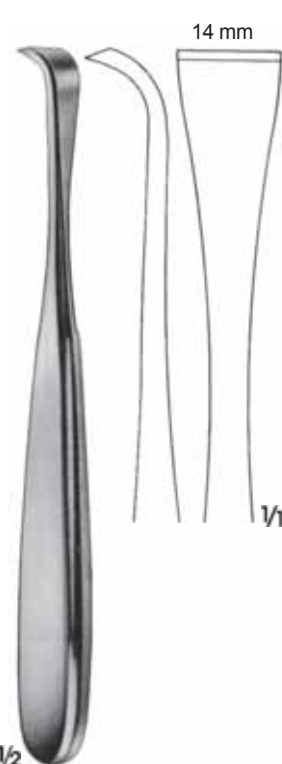

SCHNEIDER - SAUERBRUCH
M 271.01
19 cm

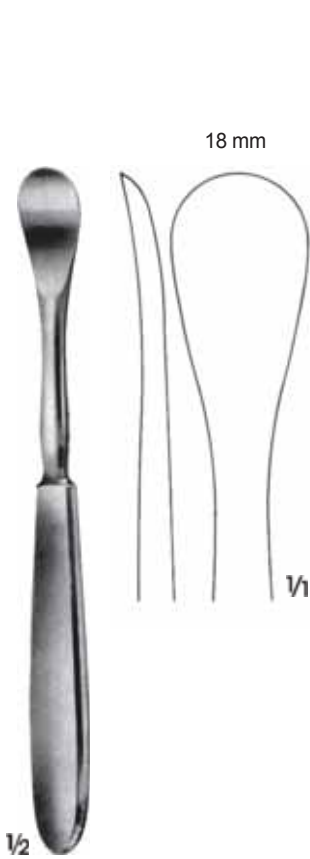

SEDILLOT
M 275.01
18.5 cm



SEDILLOT
M 276.01
21.5 cm



LAMBOTTE
M 278.01 - M 278.05
21.5 cm

- M 278.01** 5 mm
- M 278.02** 10 mm
- M 278.03** 15 mm
- M 278.04** 20 mm
- M 278.05** 25 mm



KEY
M 300.01 - M 300.04
19 cm

M 300.04
25 mm

M 300.03
19 mm

M 300.02
12 mm

M 300.01
6 mm

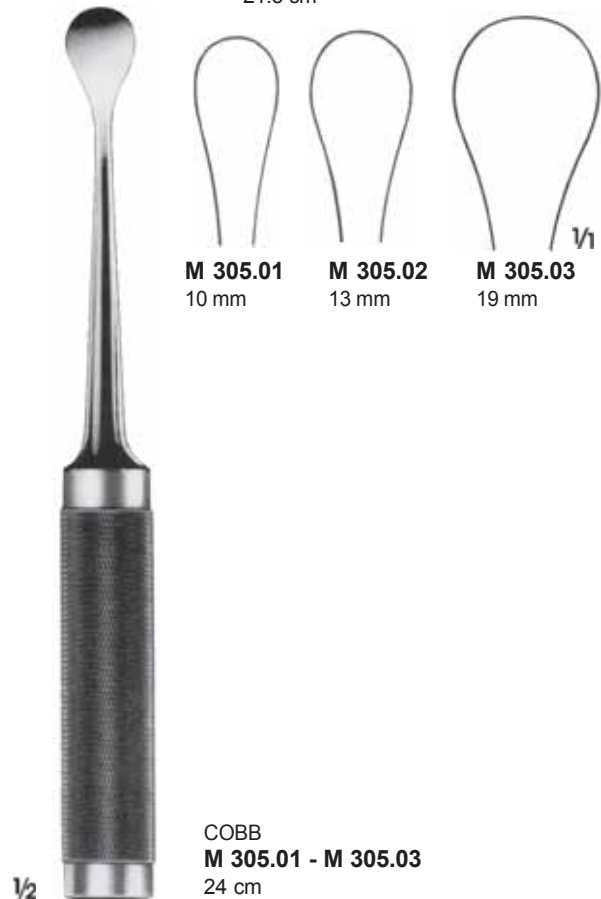

COBB
M 305.01 - M 305.03
24 cm

M 305.01
10 mm

M 305.02
13 mm

M 305.03
19 mm



M 310.01
19 cm



M 311.01
18.5 cm



M 311.02
19 cm



M 313.01
19 cm



M 315.01
18.5 cm



M 316.01
19.5 cm



M 317.01
19 cm



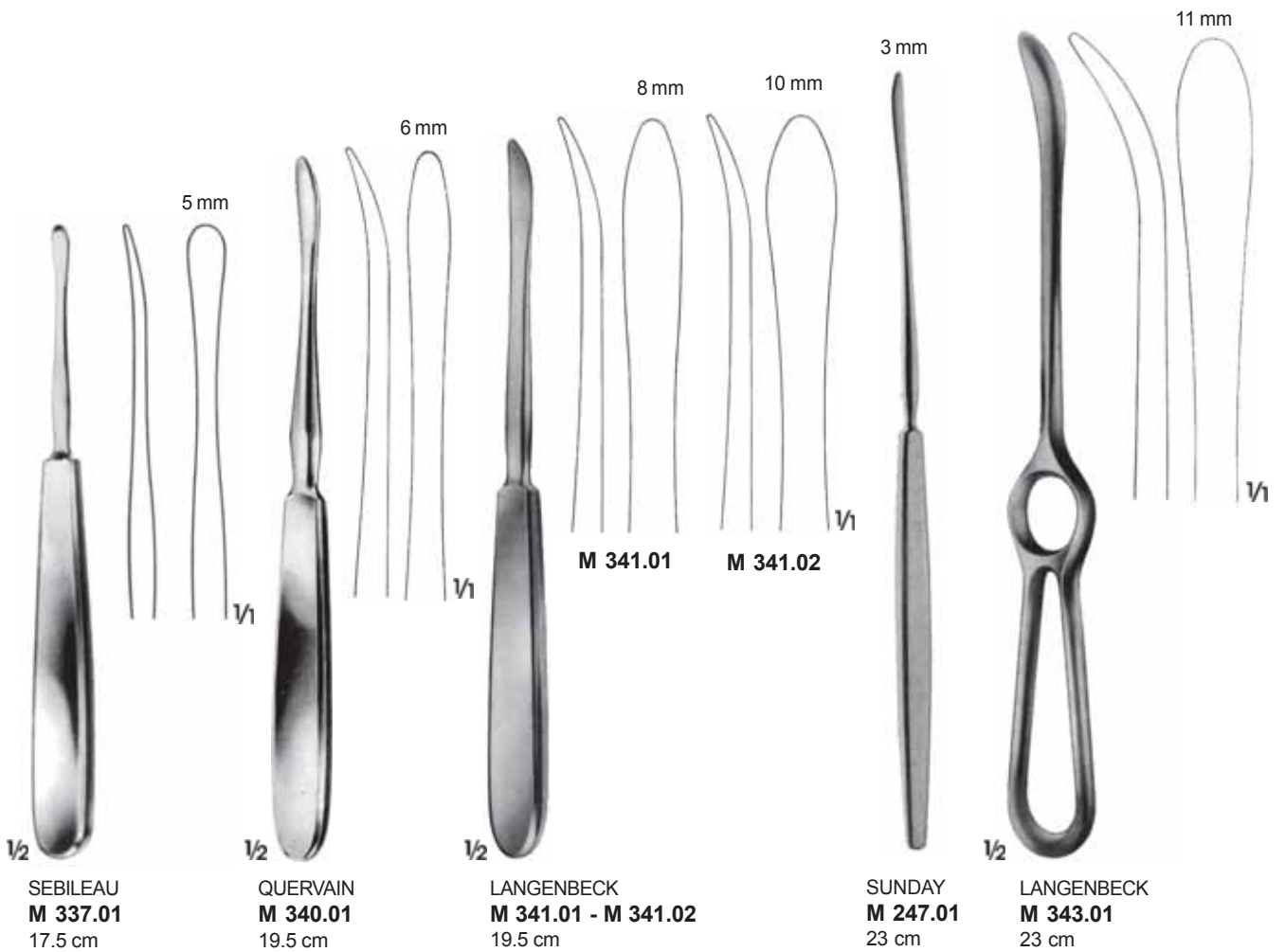
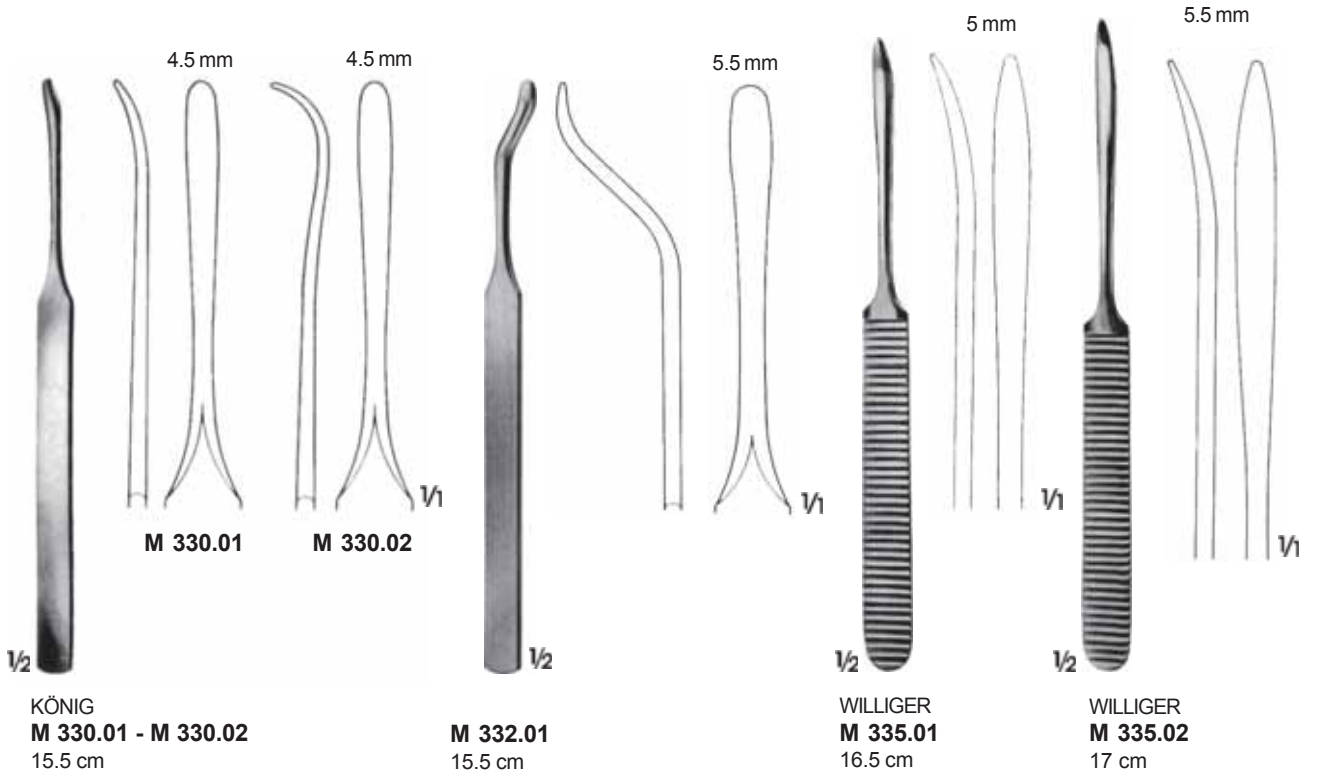



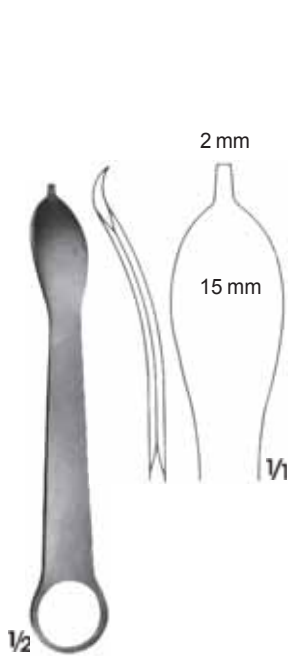

M 403.00
12.5 cm



M 400.00
14 cm

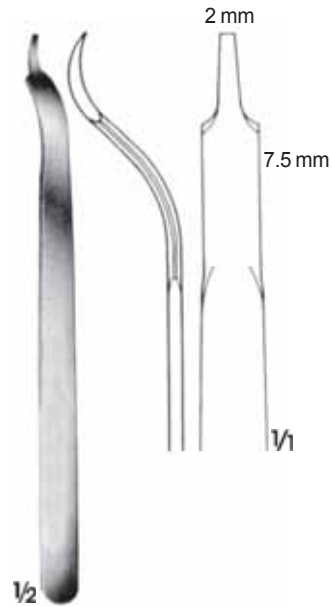

BUCK - GRAMCKO
M 401.00
15 cm

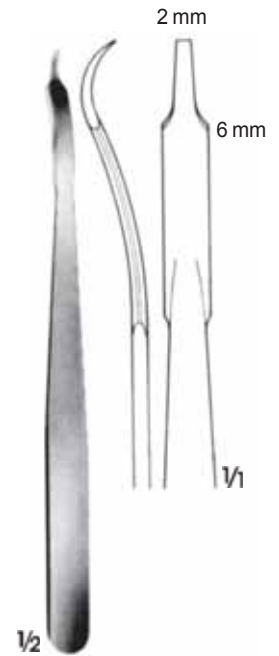

M 402.00
16 cm

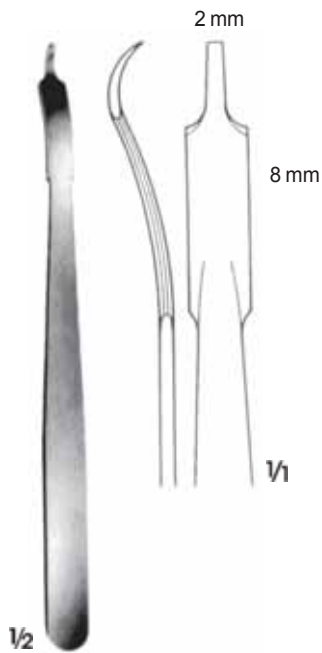

M 402.01
16 cm

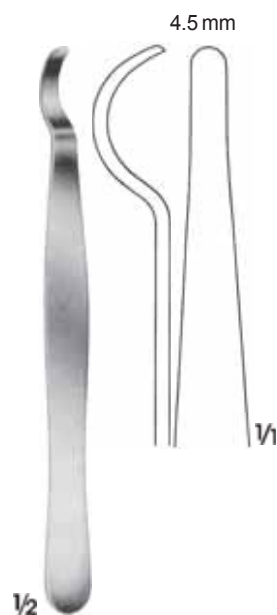

M 405.00
15 cm

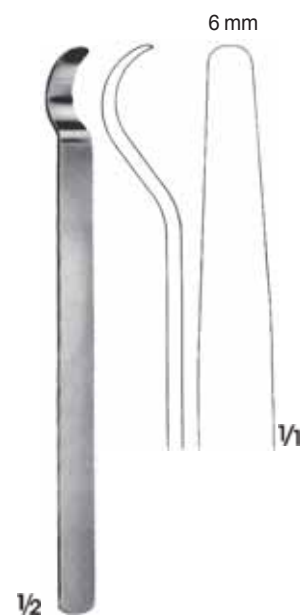

M 406.00
15 cm

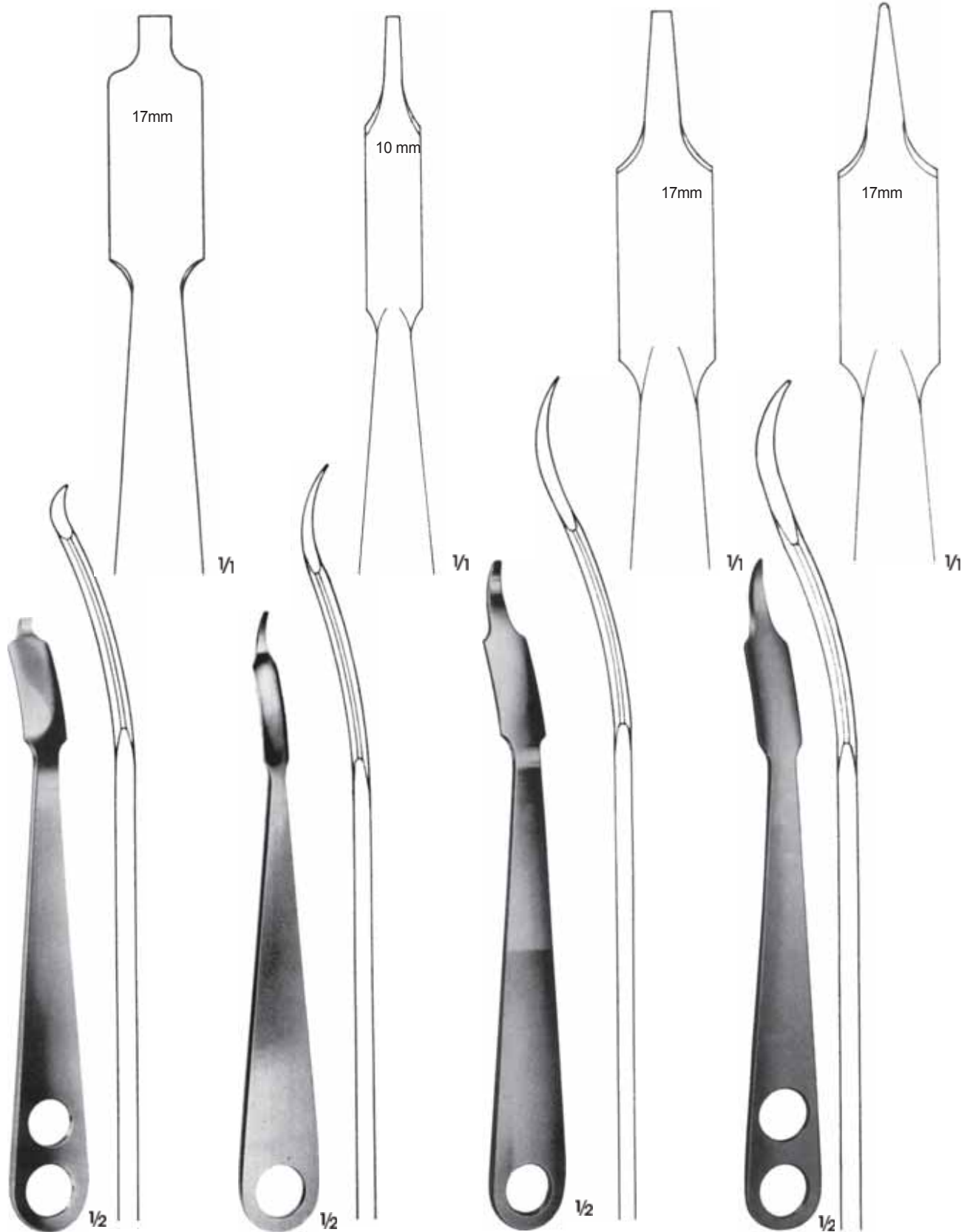

WAGNER
M 410.01
22 cm

M 412.01
22 cm

M 412.02
24 cm

M 411.02
24 cm

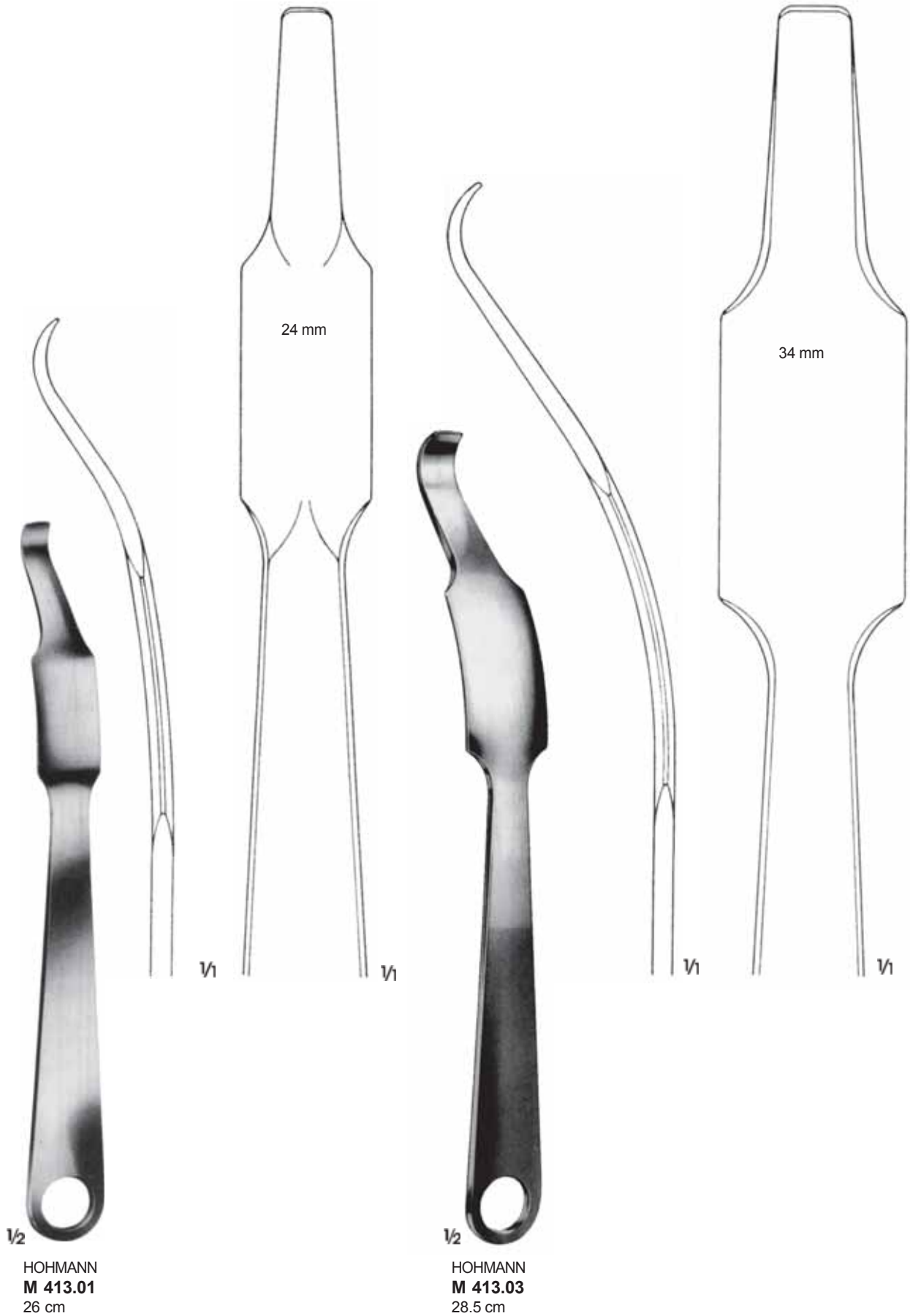

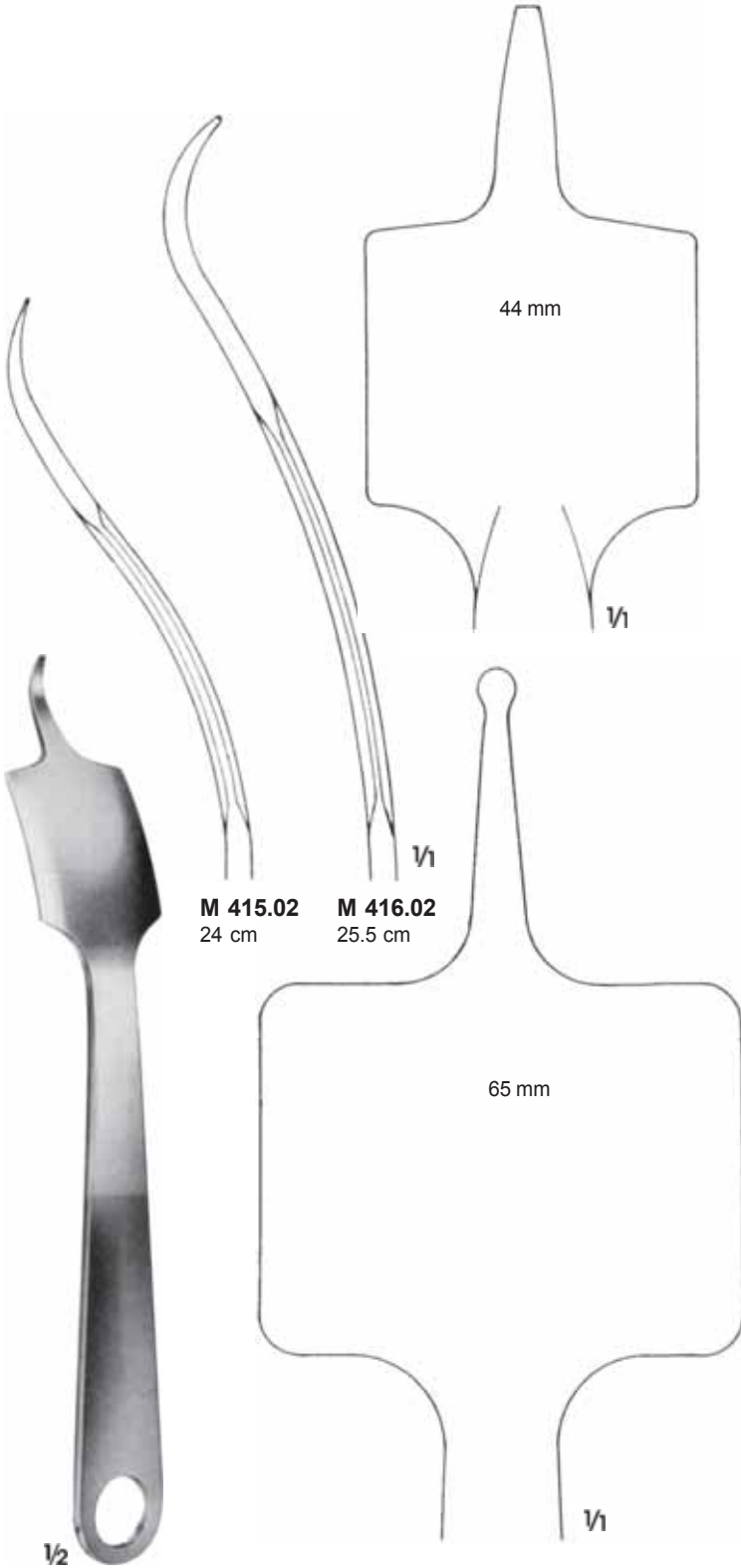

VERBRUGGE - MÜLLER
M 415.02 - M 416.02

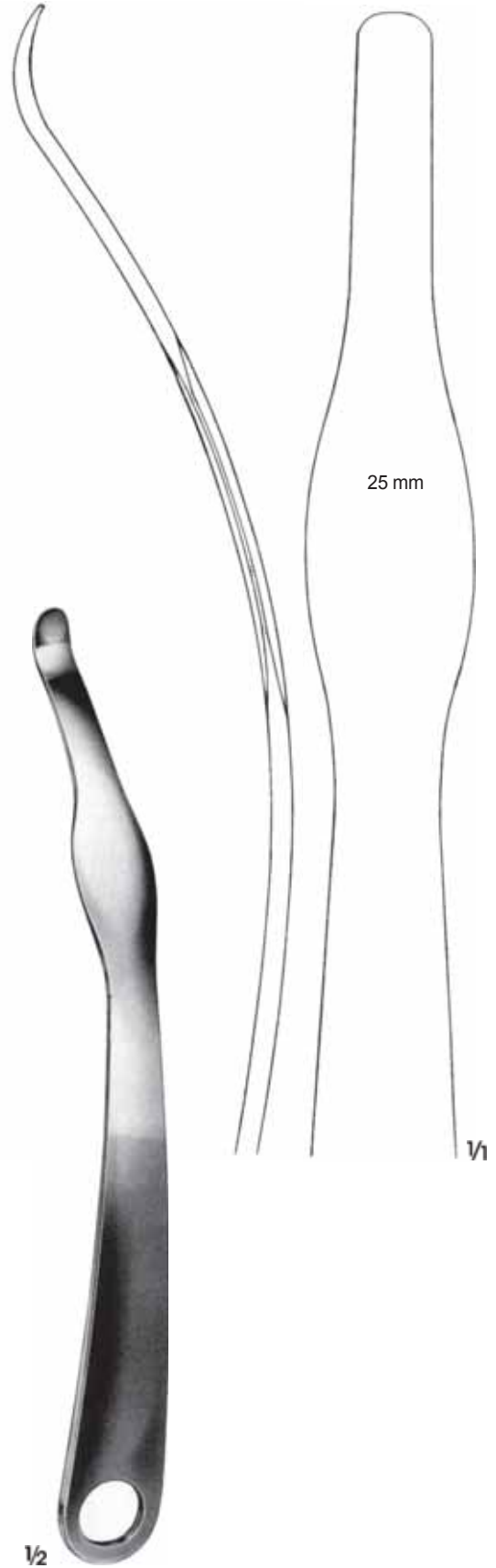

M 418.02
26 cm

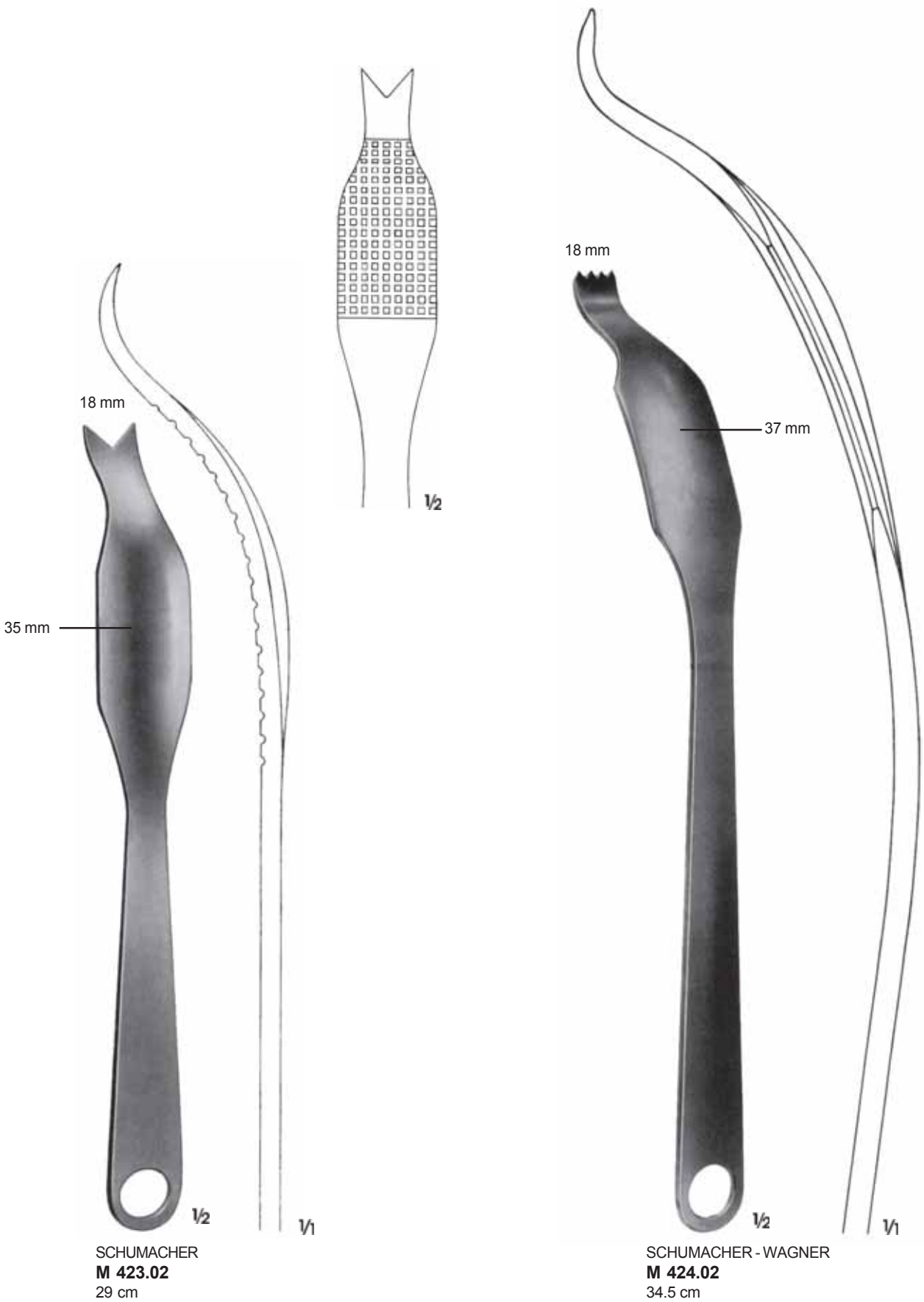



1/2
BLOUNT
M 430.02
26 cm



1/2
BLOUNT
M 431.02
27 cm



1/2
HOHMANN - ALDINGER
M 425.02
27 cm



M 427.01
32 cm



M 429.02
32 cm



M 434.01
Femur Ekartörü
Femoral retractor
38 cm



BENNETT
M 435.01
15 mm - 55 mm
Küçük / Small
23.5 cm

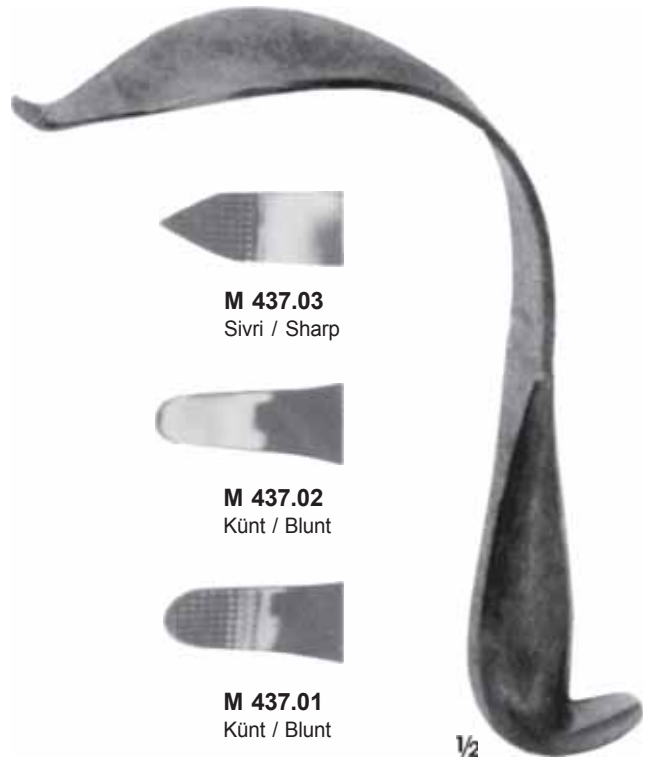

COBRA
M 437.01 - M 437.03
28 cm



TAGER
M 440.00
Mafsal elevatörleri
Bone lever for angle joint operations
17.5 cm



MURPHY - LANE
M 442.02
Düzeltilme elevatörü - Luxation lever
34 cm



BOIES
M 455.01
18 cm



GOLDMANN
M 457.01
20 cm



GILLIES
M 452.01
21 cm



SACHS
M 450.01
21 cm



DINGMANN
M 459.01
21 cm



GILLIES
M 453.01
21 cm

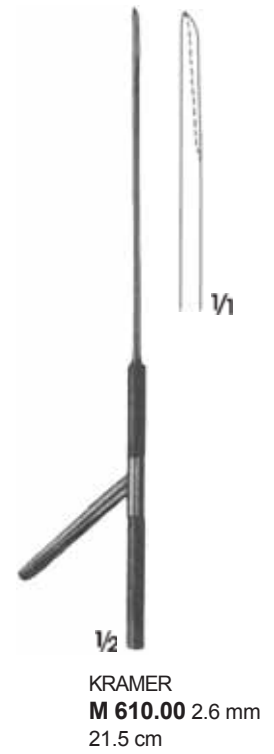
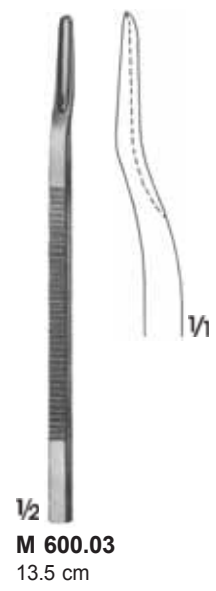
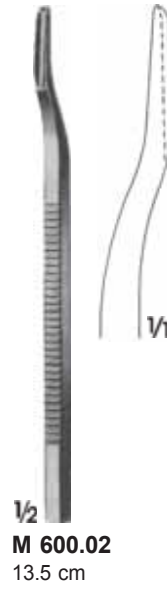
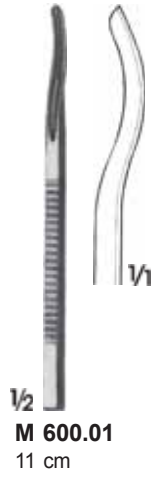

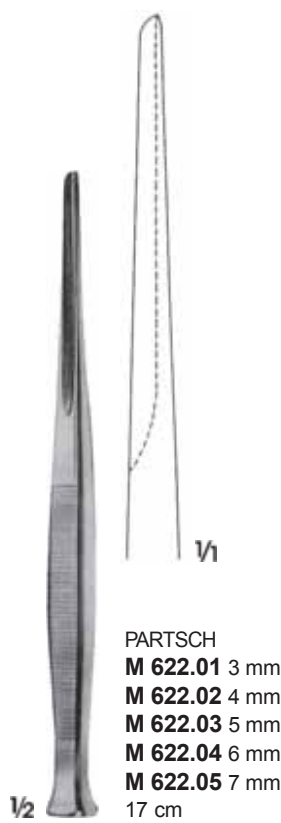
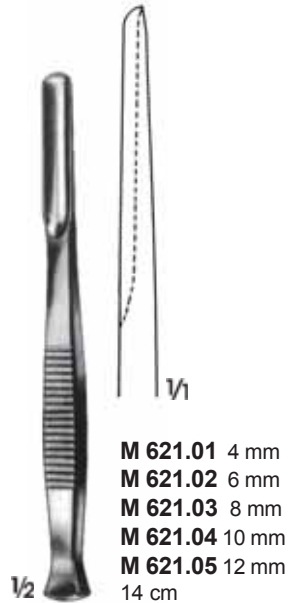
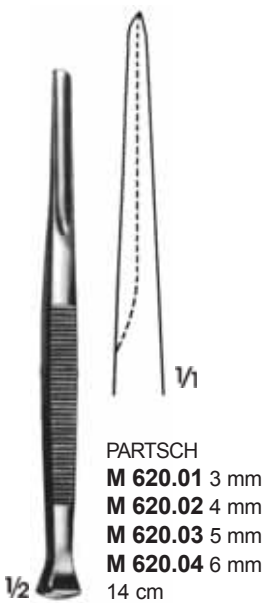
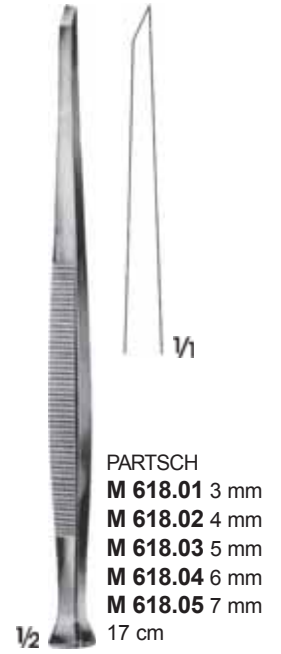
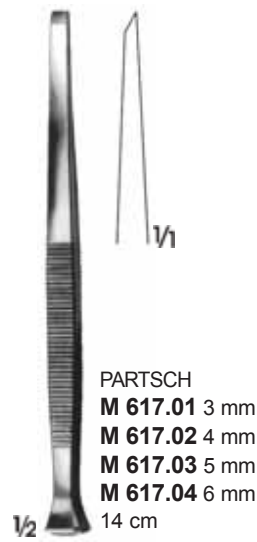
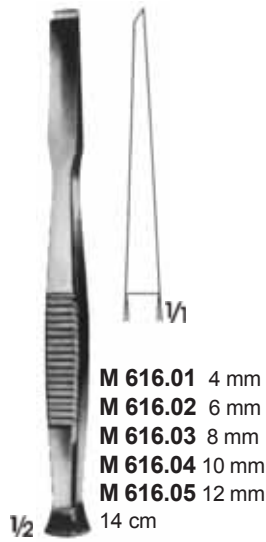
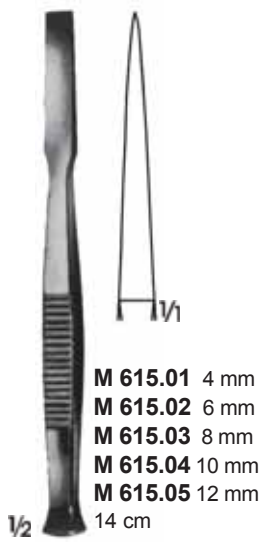
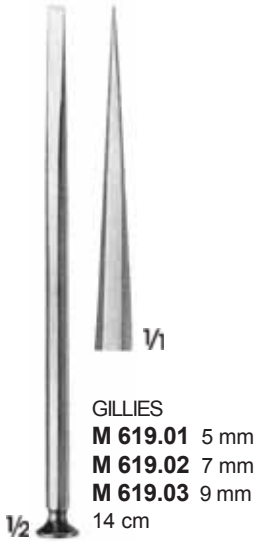

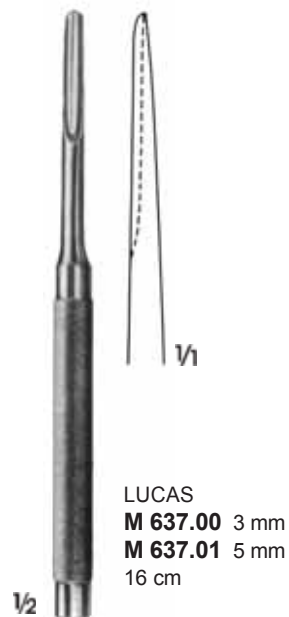
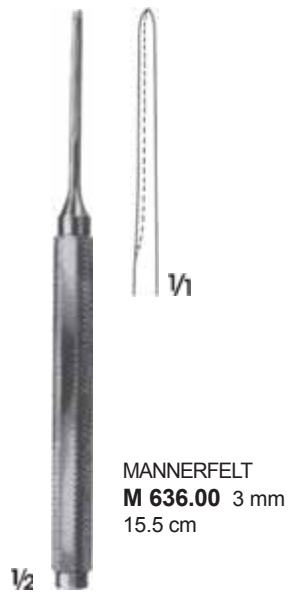
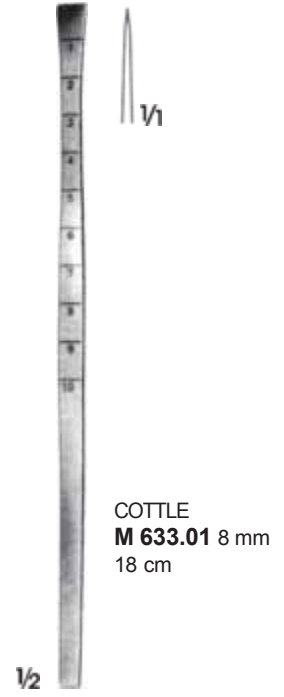
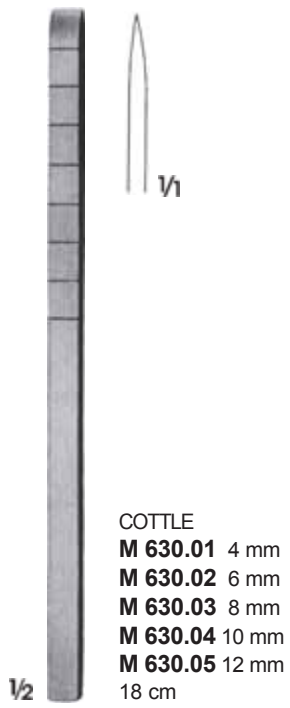

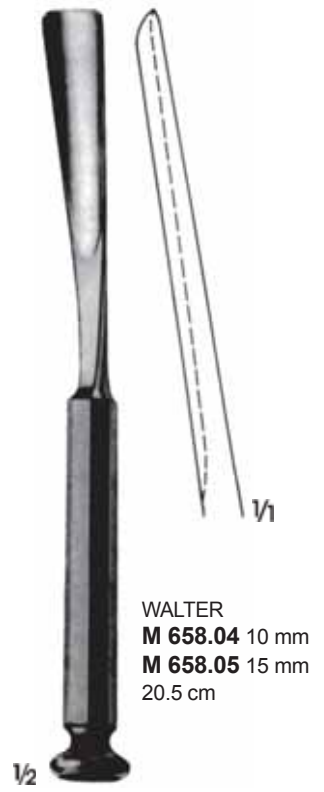
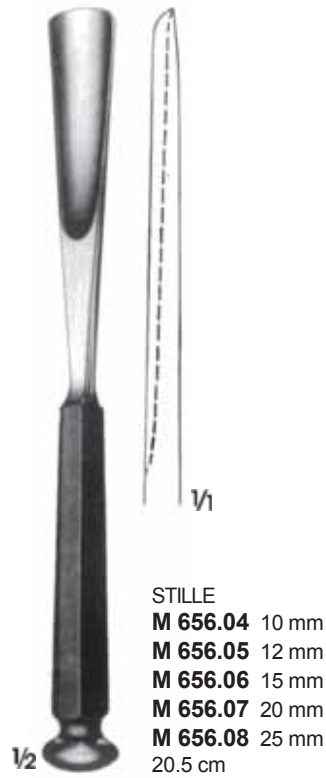
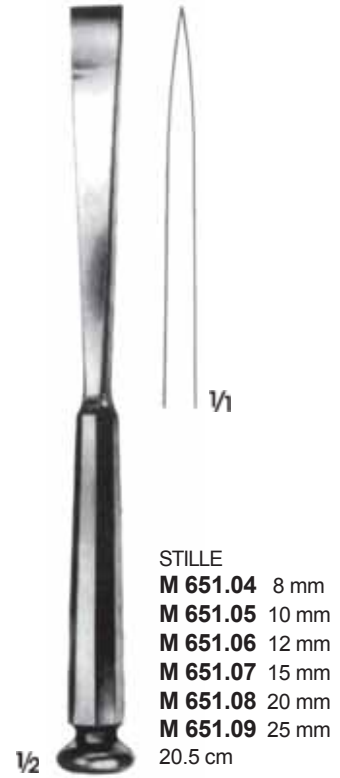
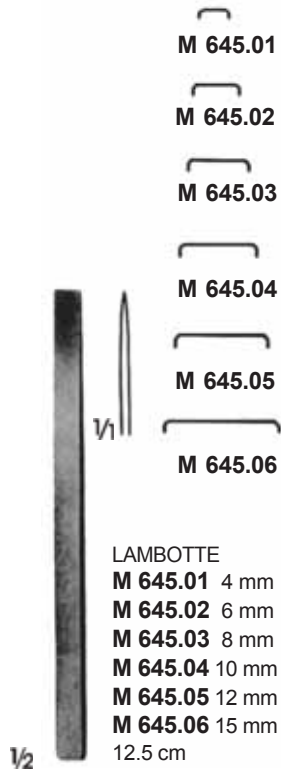

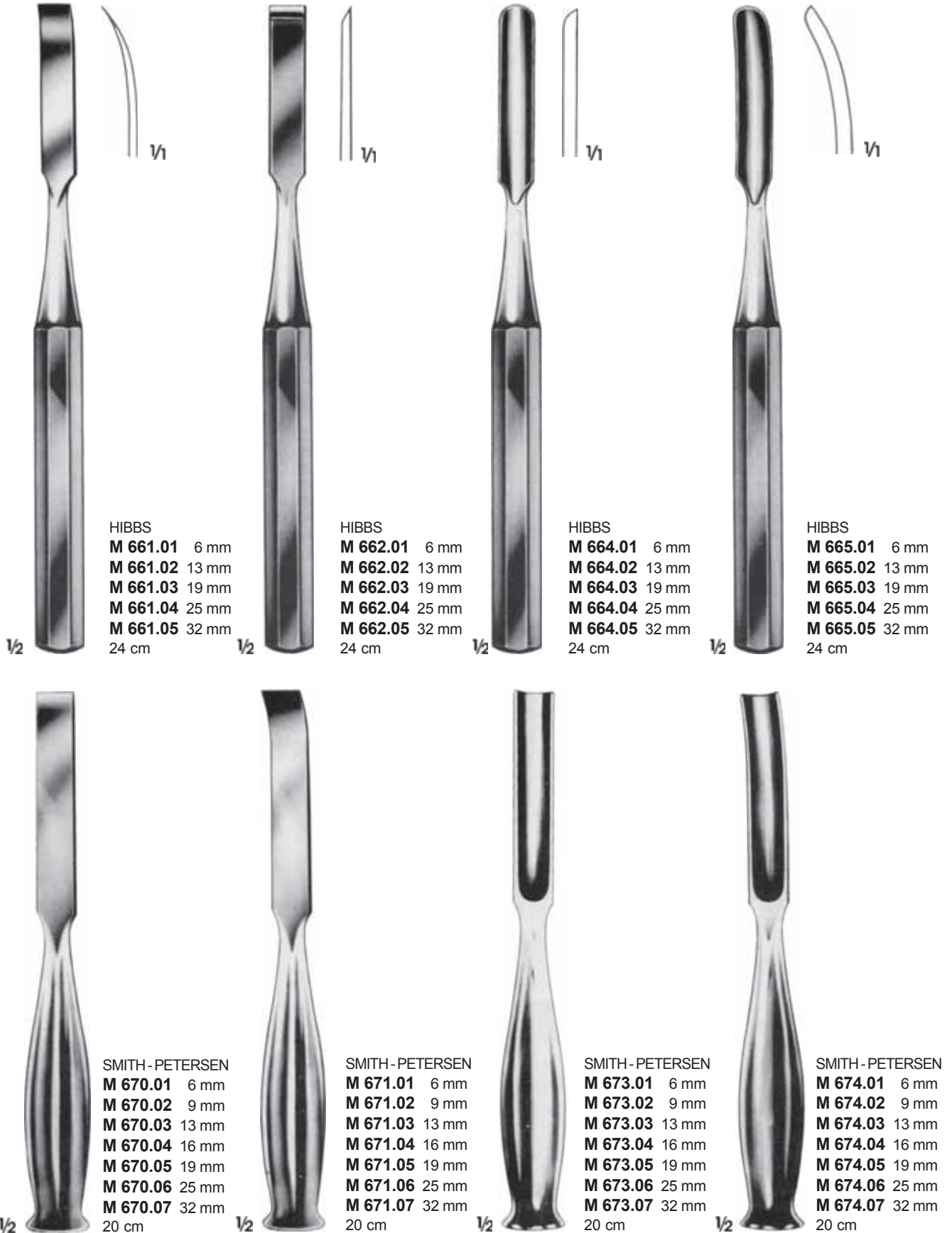

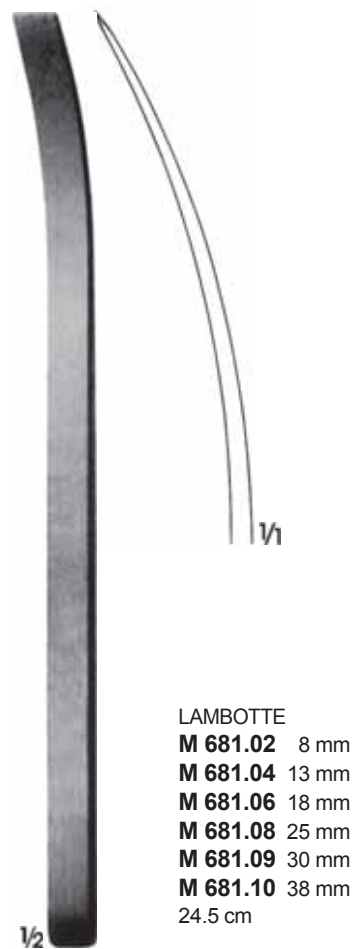
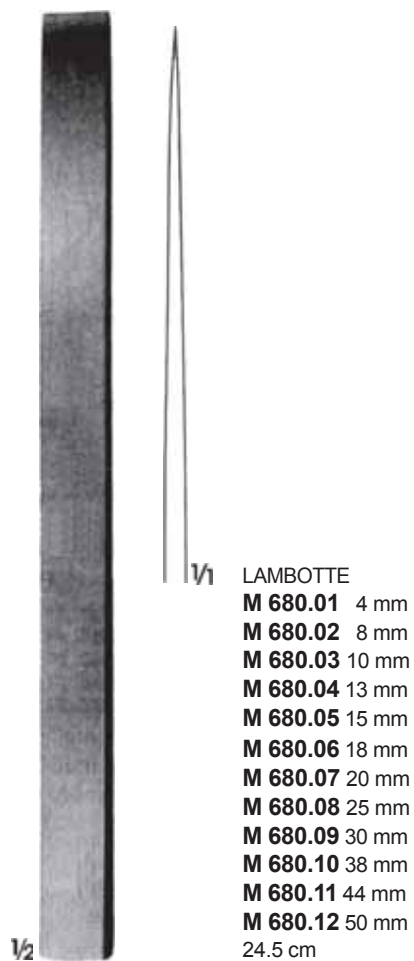

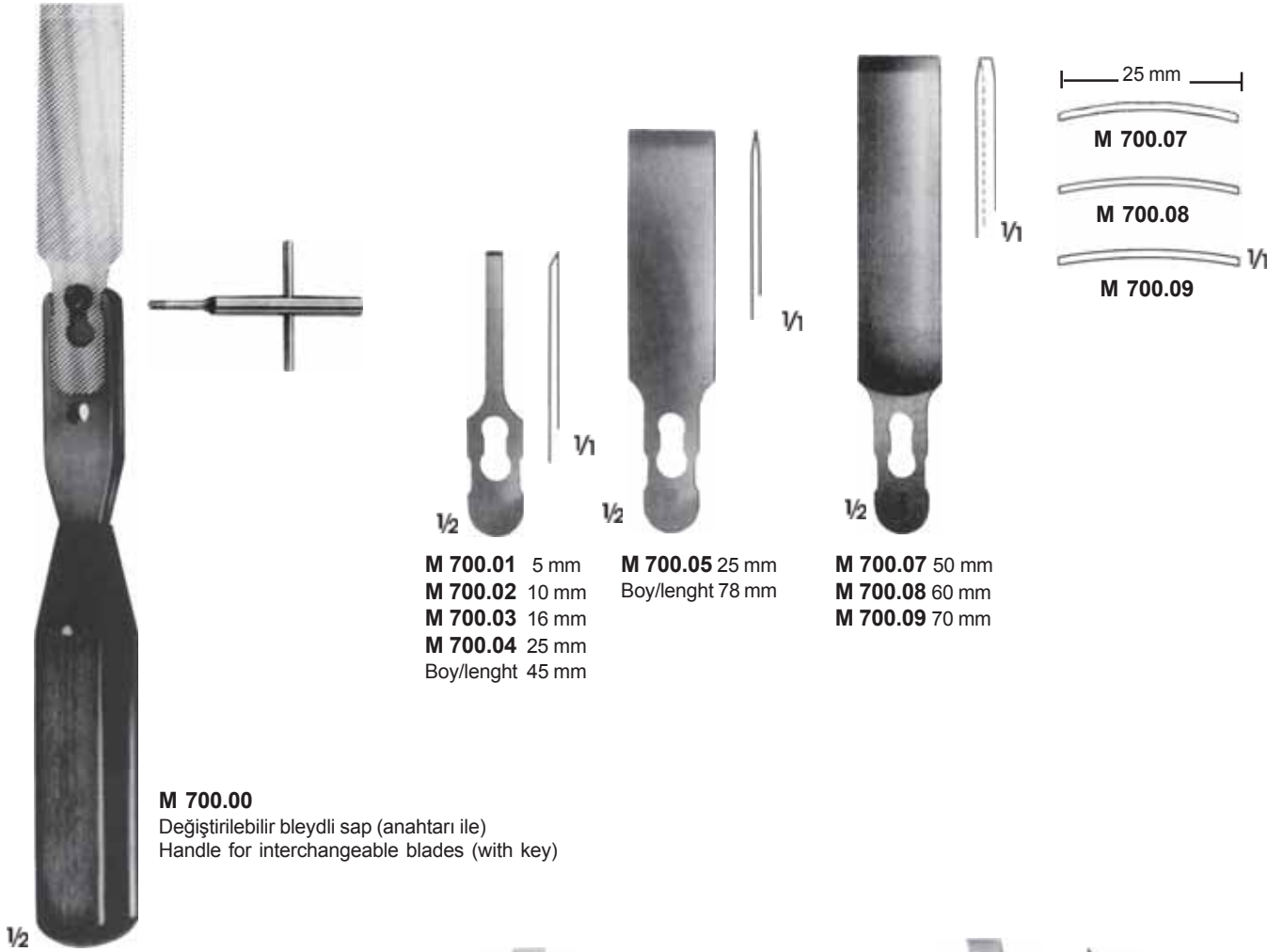

M 700.00

Değiştirilebilir bleydli sap (anahtarı ile)
Handle for interchangeable blades (with key)

M 700.01 5 mm
M 700.02 10 mm
M 700.03 16 mm
M 700.04 25 mm
Boy/lenght 45 mm

M 700.05 25 mm
Boy/lenght 78 mm

M 700.07 50 mm
M 700.08 60 mm
M 700.09 70 mm

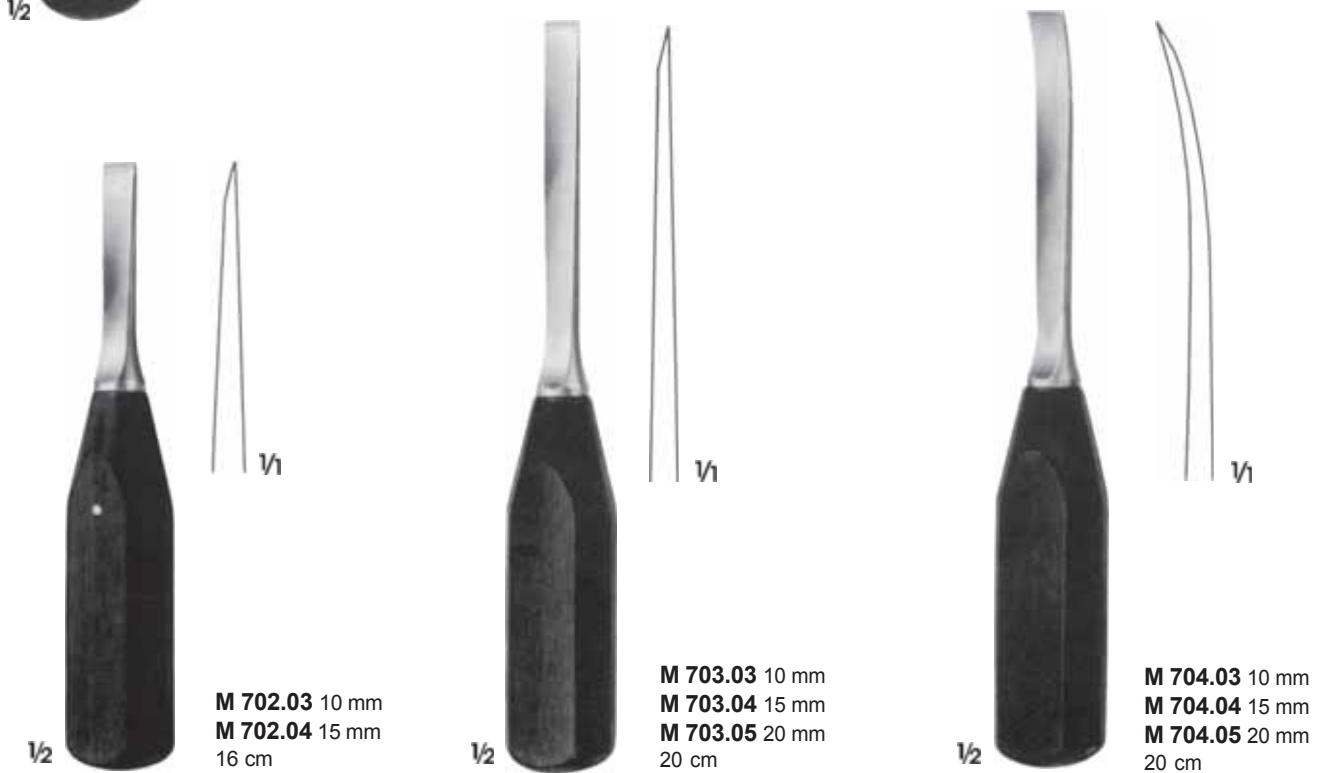

M 702.03 10 mm
M 702.04 15 mm
16 cm

M 703.03 10 mm
M 703.04 15 mm
M 703.05 20 mm
20 cm

M 704.03 10 mm
M 704.04 15 mm
M 704.05 20 mm
20 cm



LEXER-MINI
M 705.01 4 mm
M 705.02 6 mm
M 705.03 8 mm
M 705.04 10 mm
M 705.05 12 mm
 18 cm



LEXER-MINI
M 706.01 4 mm
M 706.02 6 mm
M 706.03 8 mm
M 706.04 10 mm
M 706.05 12 mm
 18 cm



LEXER
M 708.01 5 mm
M 708.02 7 mm
M 708.03 10 mm
M 708.04 15 mm
M 708.05 20 mm
M 708.06 25 mm
M 708.07 30 mm
 22 cm



LEXER
M 709.01 5 mm
M 709.02 7 mm
M 709.03 10 mm
M 709.04 15 mm
M 709.05 20 mm
M 709.06 25 mm
M 709.07 30 mm
 22 cm

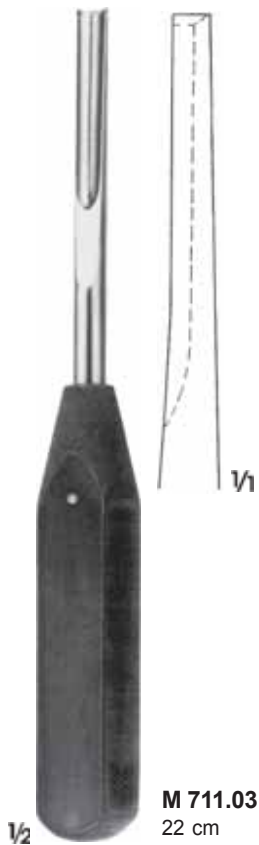

M 711.03 9 mm
 22 cm



ZIELKE
M 713.01 5.5 mm
M 713.02 9.0 mm
 23 cm



M 715.01 5 mm
M 715.02 10 mm
M 715.03 15 mm
 25 cm

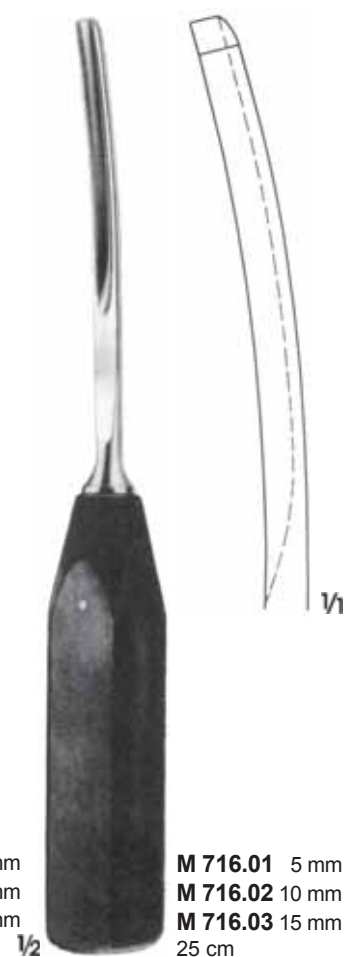

M 716.01 5 mm
M 716.02 10 mm
M 716.03 15 mm
 25 cm





M 725.01

M 725.02

Öne eğimli
Inclined forward

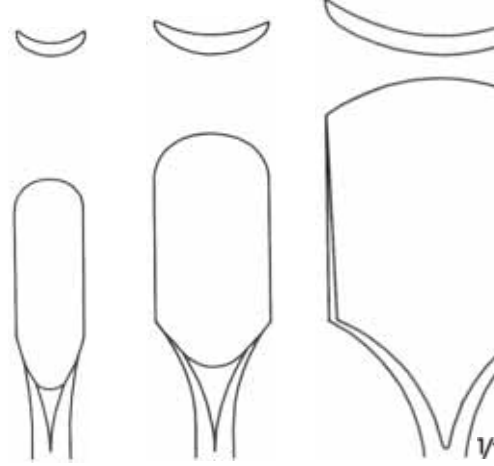

M 727.01
9 mm

M 727.02
15 mm

M 727.03
30 mm



1/2

1/2

LEXER
M 725.01 - M 725.02
28 cm

WAGNER
M 727.01 - M 727.03
M 728.01 - M 728.03
M 729.01 - M 729.03
34 cm

Geri eğimli
Inclined backward

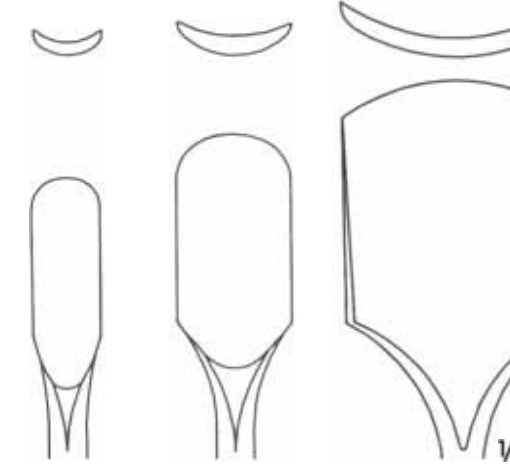

M 728.01
9 mm

M 728.02
15 mm

M 728.03
30 mm

Düz / straight

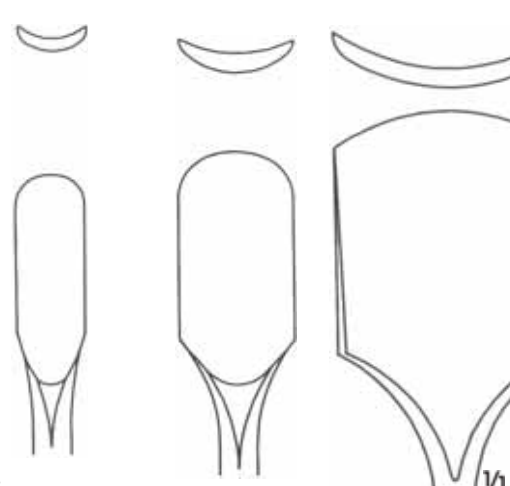

M 729.01
9 mm

M 729.02
15 mm

M 729.03
30 mm

Radius 40 mm

Radius 50 mm



Kisa Bleydli
Short Blade
40 mm

Orta Bleydli
Medium Blade
40 mm

Uzun Bleydli
Long Blade
40 mm

30 mm

R= 40 mm
R= 50 mm

R=40 mm

R=50 mm

R= 40 mm
R= 50 mm

1/2

1/2

1/2

1/2

WAGNER
M 730.01

WAGNER
M 730.03

WAGNER

WAGNER
M 732.01

M 730.02
40 cm

37 cm

M 730.06
40 cm

M 732.02
32 cm





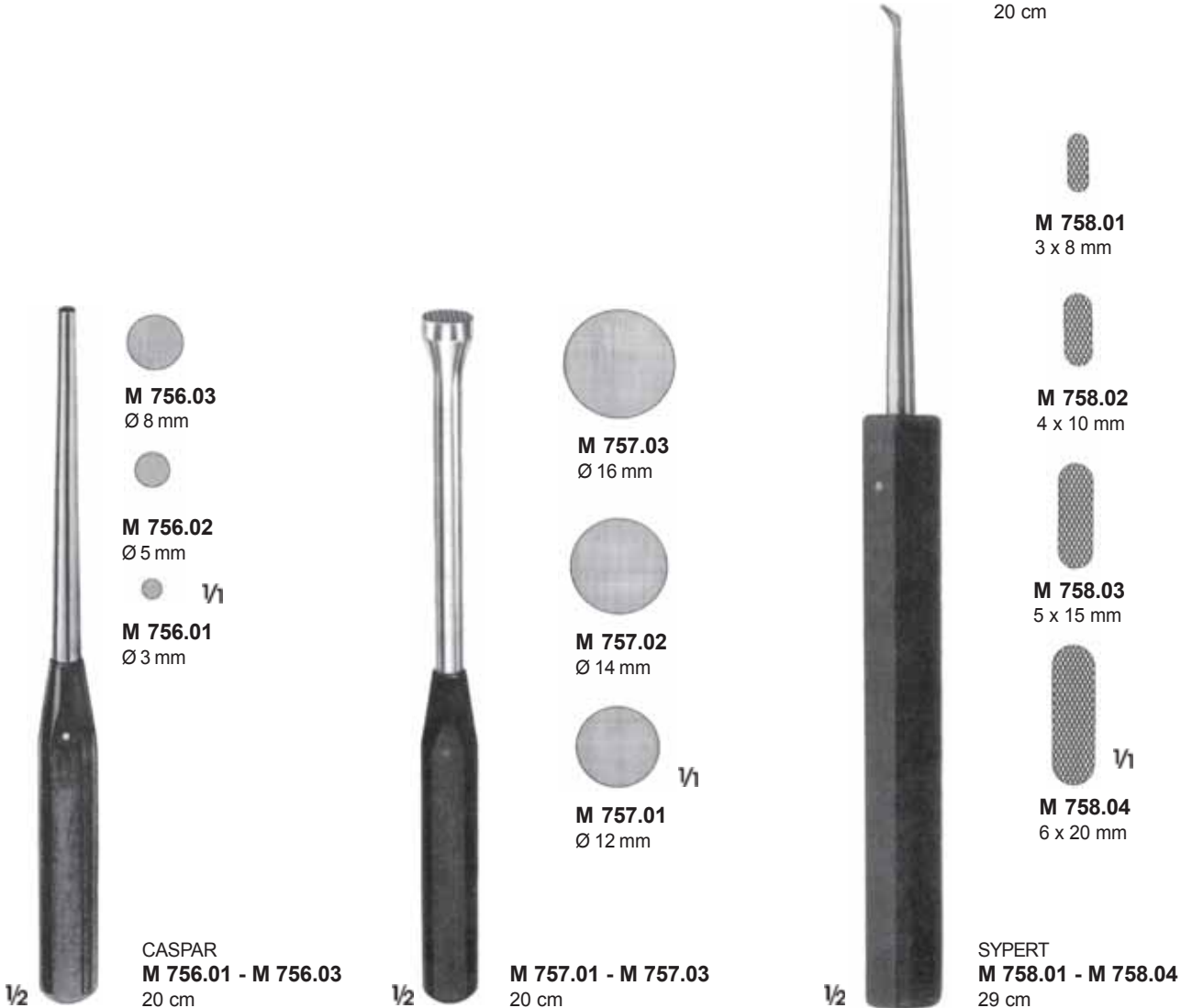





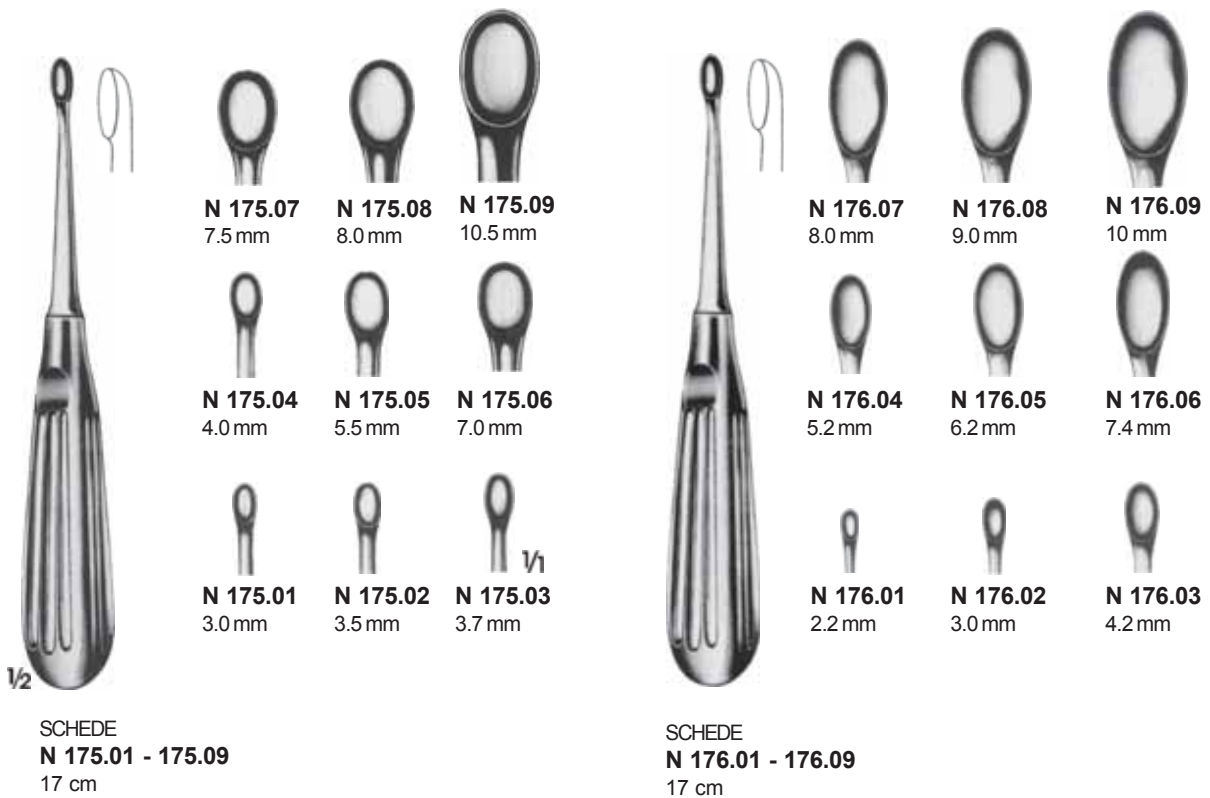
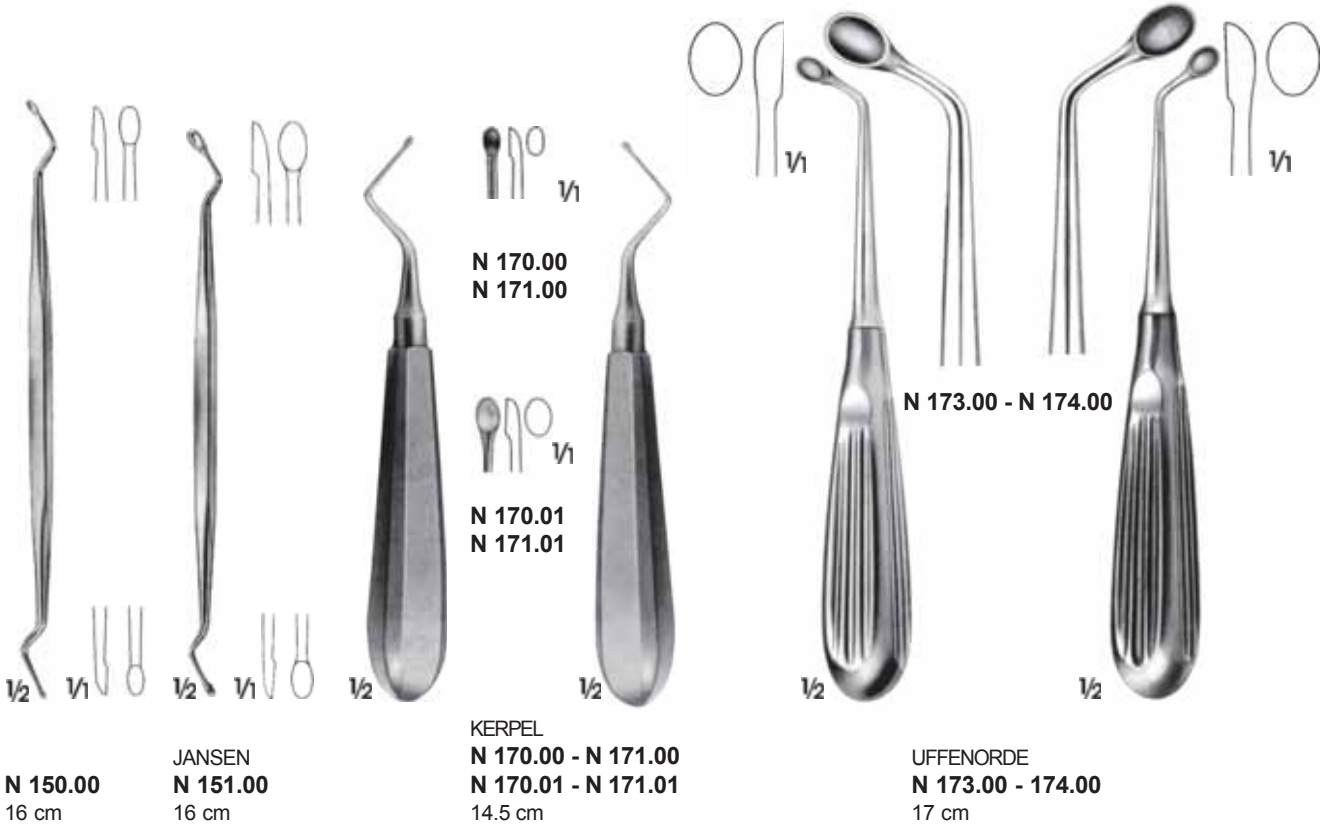

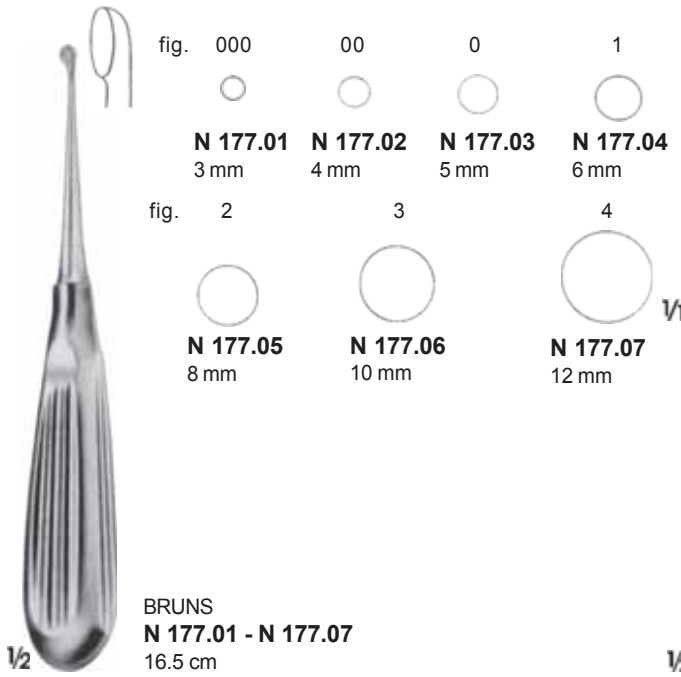

BRUNS
N 177.01 - N 177.07
16.5 cm

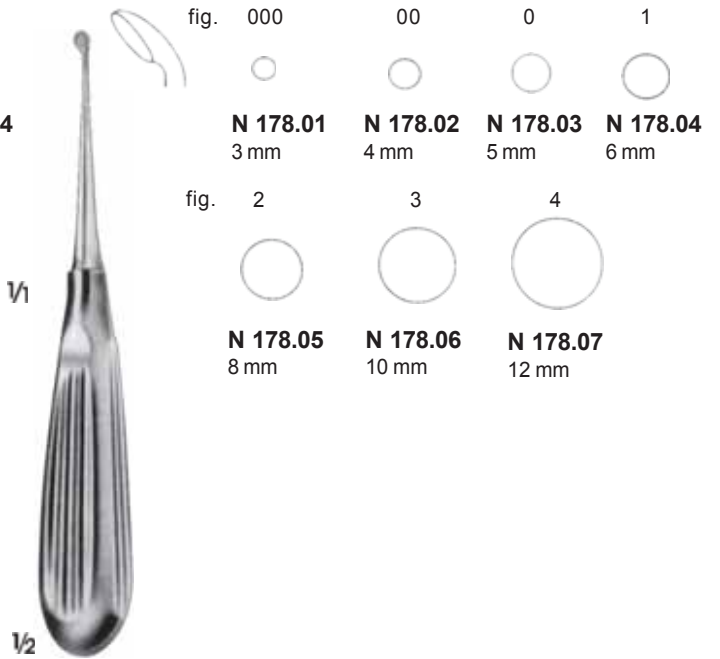

BRUNS
N 178.01 - N 178.07
16.5 cm

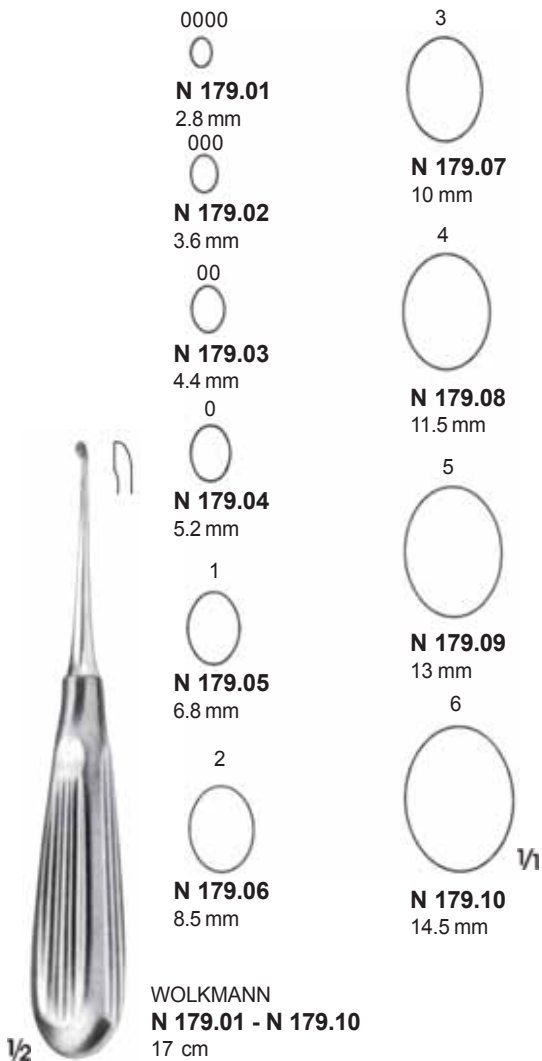

WOLKMANN
N 179.01 - N 179.10
17 cm

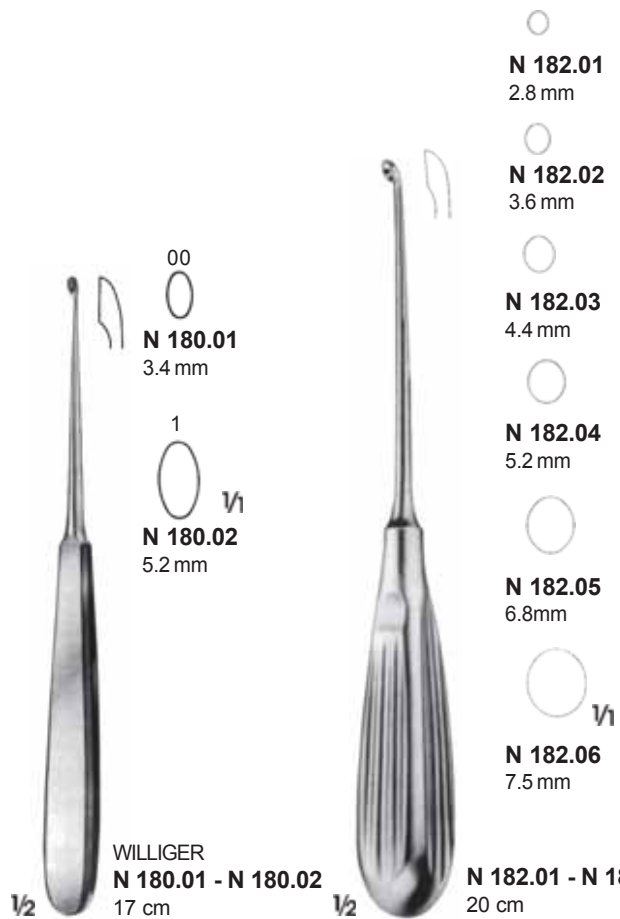

WILLIGER
N 180.01 - N 180.02
17 cm

N 182.01 - N 182.06
20 cm

 <p>N 183.01 2.8 mm</p>  <p>N 183.02 3.6 mm</p>  <p>N 183.03 4.4 mm</p>  <p>N 183.04 5.2 mm</p>  <p>N 183.05 6.8 mm</p>  <p>N 183.06 7.5 mm</p>	 <p>N 184.01 2.8 mm</p>  <p>N 184.02 3.6 mm</p>  <p>N 184.03 4.4 mm</p>  <p>N 184.04 5.2 mm</p>  <p>N 184.05 6.8 mm</p>  <p>N 184.06 7.5 mm</p>	 <p>0000 N 185.01 2.8 mm</p>  <p>000 N 185.02 3.6 mm</p>  <p>00 N 185.03 4.4 mm</p>  <p>0 N 185.04 5.2 mm</p>	 <p>N 186.01 1.8 mm</p>  <p>N 186.02 2.0 mm</p>  <p>N 186.03 2.4 mm</p>  <p>N 186.04 2.6 mm</p>  <p>N 186.05 2.8 mm</p>
<p>N 183.01 - N 183.06 20 cm</p>	<p>N 184.01 - N 184.06 20 cm</p>	<p>DAUBENSPECK N 185.01 - N 185.04 20 cm</p>	<p>LEMPERT N 186.01 - N 186.05 21.5 cm</p>
 <p>00 N 187.01 4.4 mm</p>  <p>0 N 187.02 5.2 mm</p>  <p>1 N 187.03 6.8 mm</p> <p>HALLE N 187.01 - N 187.03 21.5 cm</p>	 <p>000 N 190.01 3.6 mm</p>  <p>00 N 190.02 4.4 mm</p>  <p>0 N 190.03 5.2 mm</p>  <p>1 N 190.04 6.8 mm</p> <p>N 190.01 - N 190.04 25 cm</p>	 <p>000 N 192.01 3.6 mm</p>  <p>00 N 192.02 4.4 mm</p>  <p>0 N 192.03 5.2 mm</p>  <p>1 N 192.04 6.8 mm</p> <p>N 192.01 - N 192.04 25 cm</p>	 <p>N 193.01 3 mm</p>  <p>N 193.02 4 mm</p>  <p>N 193.03 5 mm</p> <p>BUSHE N 193.01 - N 193.03 25 cm</p>

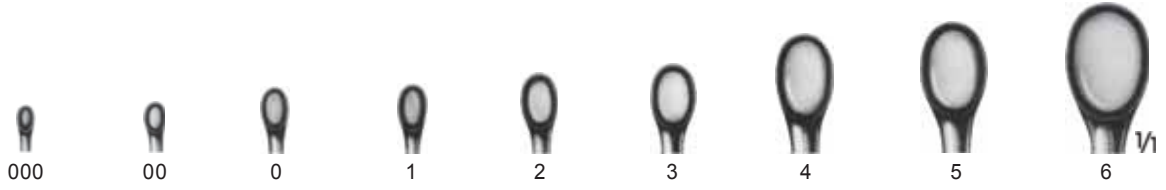

N 205.01 1.8 mm	N 205.02 2.2 mm	N 205.03 3.5 mm	N 205.04 4.0 mm	N 205.05 4.5 mm	N 205.06 5.5 mm	N 205.07 7.2 mm	N 205.08 8.5 mm	N 205.09 10.5 mm
N 206.01 1.8 mm	N 206.02 2.2 mm	N 206.03 3.5 mm	N 206.04 4.0 mm	N 206.05 4.5 mm	N 206.06 5.5 mm	N 206.07 7.2 mm	N 206.08 8.5 mm	N 206.09 10.5 mm
N 210.01 1.8 mm	N 210.02 2.2 mm	N 210.03 3.5 mm	N 210.04 4.0 mm	N 210.05 4.5 mm	N 210.06 5.5 mm	N 210.07 7.2 mm	N 210.08 8.5 mm	N 210.09 10.5 mm
N 211.01 1.8 mm	N 211.02 2.2 mm	N 211.03 3.5 mm	N 211.04 4.0 mm	N 211.05 4.5 mm	N 211.06 5.5 mm	N 211.07 7.2 mm	N 211.08 8.5 mm	N 211.09 10.5 mm





N 220.00
3.0 mm



N 220.01
3.6 mm



N 220.02
4.2 mm



N 220.03
5.0 mm



N 220.04
6.2 mm



N 220.05
7.0 mm



N 220.06
8.2 mm



N 220.07
9.0 mm



N 220.08
10.5 mm



1/2

SPINAL
N 220.00 - N 220.08
23 cm



N 220.10
3.0 mm



N 220.11
3.6 mm



N 220.12
4.2 mm



N 220.13
5.0 mm



N 220.14
6.2 mm



N 220.15
7.0 mm



N 220.16
8.2 mm



N 220.17
9.0 mm



N 220.18
10.5 mm



1/2

SPINAL
N 220.10 - N 220.18
28 cm



N 225.00
3.0 mm



N 225.01
3.6 mm



N 225.02
4.2 mm



N 225.03
5.0 mm



N 225.04
6.2 mm



N 225.05
7.0 mm



N 225.06
8.2 mm



N 225.07
9.0 mm



N 225.08
10.5 mm



1/2

COBB
N 225.00 - N 225.08
28 cm



N 235.00
Ø 4 mm

N 235.01
Ø 5 mm

N 235.02
Ø 6 mm



1/2

KRAMER
N 235.00 - N 235.02
Çift taraflı / Double sided
25 cm



1/2

N 280.01 - N 280.04
27 cm

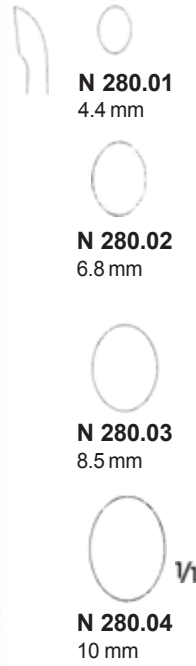

N 280.01
4.4 mm

N 280.02
6.8 mm

N 280.03
8.5 mm

N 280.04
10 mm



1/2

N 281.02
30 cm



SIMON
N 500.06 -N 500.11
24 cm

GOURDET
N 510.06 -N 510.14
Künt / Blunt
28 cm

SCHRÖDER
N 502.06 -N 502.11
31 cm







GALLAHER
N 328.01
19 cm

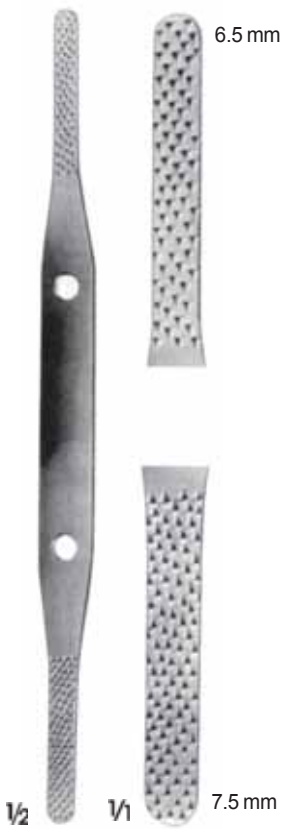

FOMON
N 325.01
21.5 cm



FOMON
N 326.01
21.5 cm



N 330.01 - N 330.05
20.5 cm



N 330.01

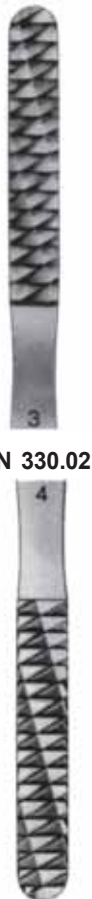

N 330.02

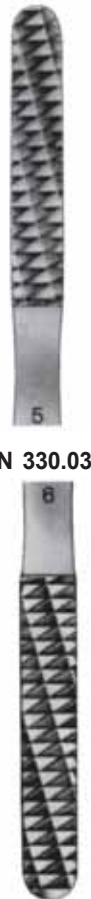

N 330.03

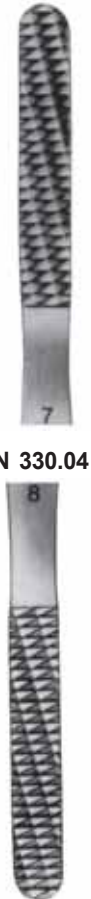

N 330.04

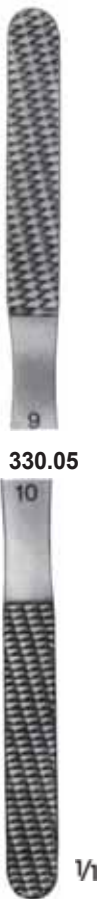

N 330.05



N 335.01
Bir tarafı eğe / One side file cut
Bir tarafı Raspa / One side rasp cut
22 cm

N 340.01
24 cm

EICHLER
N 342.01 - N 342.02
Delikli kemik Rasparları
Cancellous bone rasps
24.5 cm

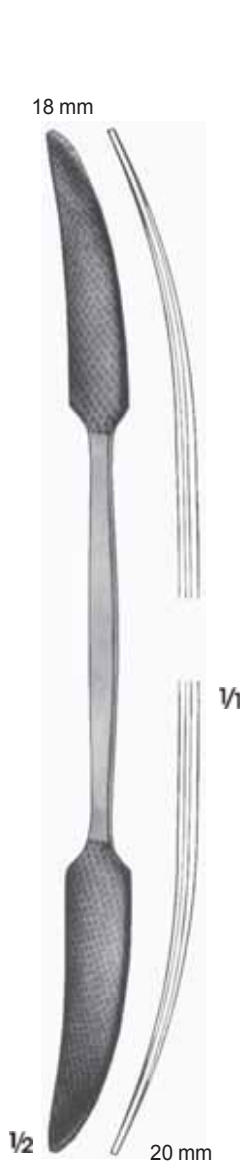

PUTTI
N 345.01
27 cm



N 348.01
29.5 cm



PUTTI
N 347.01
30 cm

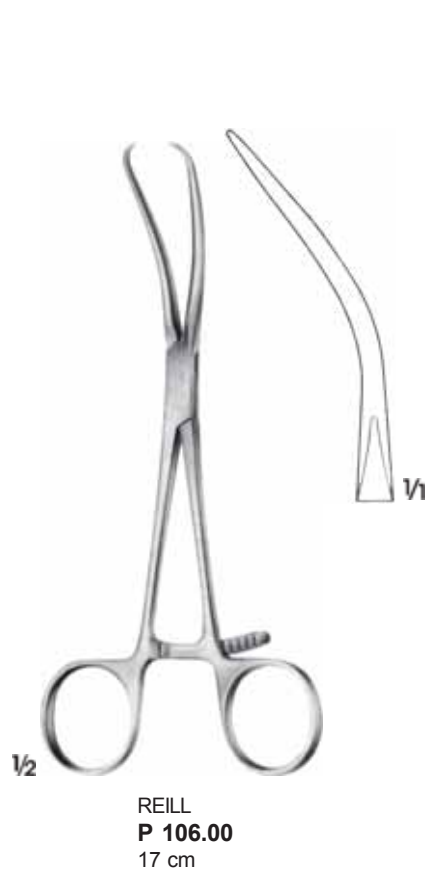

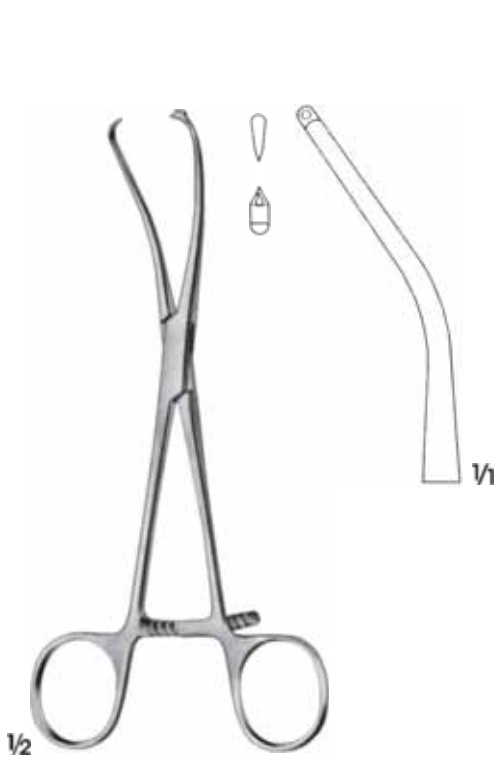

MEYER
P 110.00
Kullanılan tel Ø 1.0 mm
For wires with Ø 1.0 mm
17 cm

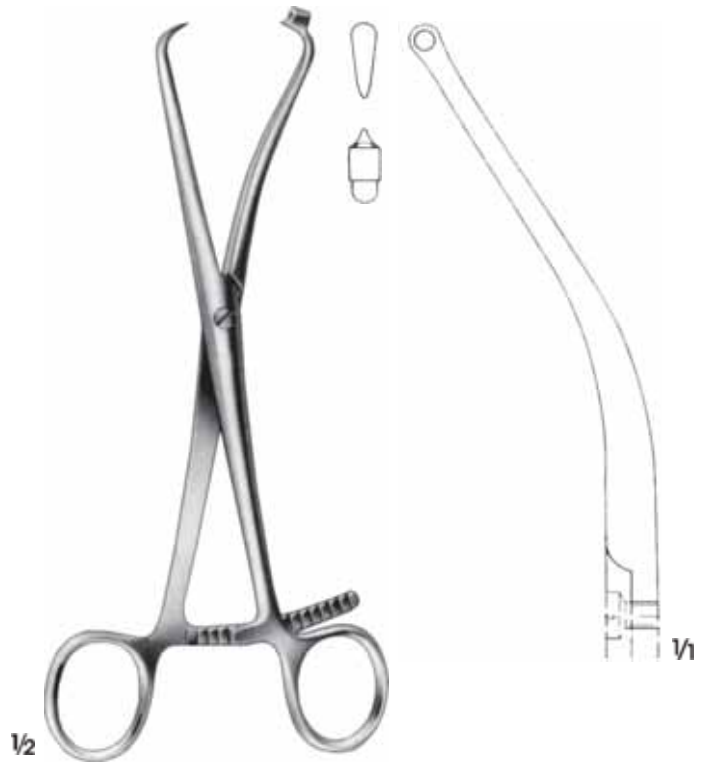

MEYER
P 112.00
Tel Ø 2.0 mm
For wires Ø 2.0 mm
20.5 cm



P 115.00
18.5 cm



P 113.00
21 cm



T 380.00
Tel Ø 3.0 mm
For wires Ø 3.0 mm



FÖRSTNER
P 120.00
10 cm



P 121.00
13.5 cm



FÖRSTNER
P 120.01
14 cm



P 123.00
13.5 cm



HAASE
P 124.00
14 cm



P 128.00
14 cm



CASPAR
P 129.00
18 cm



DINGMANN
P 126.00
18.5 cm



DINGMANN
P 125.00
18.5 cm



P 130.01
20 cm



P 131.01
20 cm



VAN BUREN
P 133.01
22.5 cm

Yana eğri
Laterally curved



**LEWIN
P 140.01
17.5 cm**

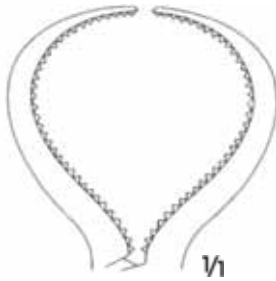

**SEMB
P 135.00
19 cm**



**SEMB
P 136.00
19 cm**



**P 142.00
14 cm**



**P 143.00
17 cm**



**P 143.01
23.5 cm**

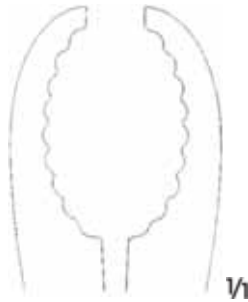

P 145.02
28 cm

1/1



P 146.02
28 cm

1/1



P 145.01
25 cm



P 146.01
25 cm

1/1

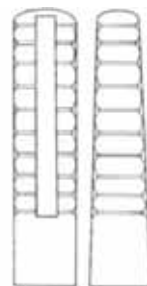

P 145.00
23 cm



P 146.00
23 cm



1/2

ULRICH
P 145.00 - P 145.02



1/2

ULRICH
P 146.00 - P 146.02





BISHOP
P 158.01
23 cm



BISHOP
P 158.03
32 cm





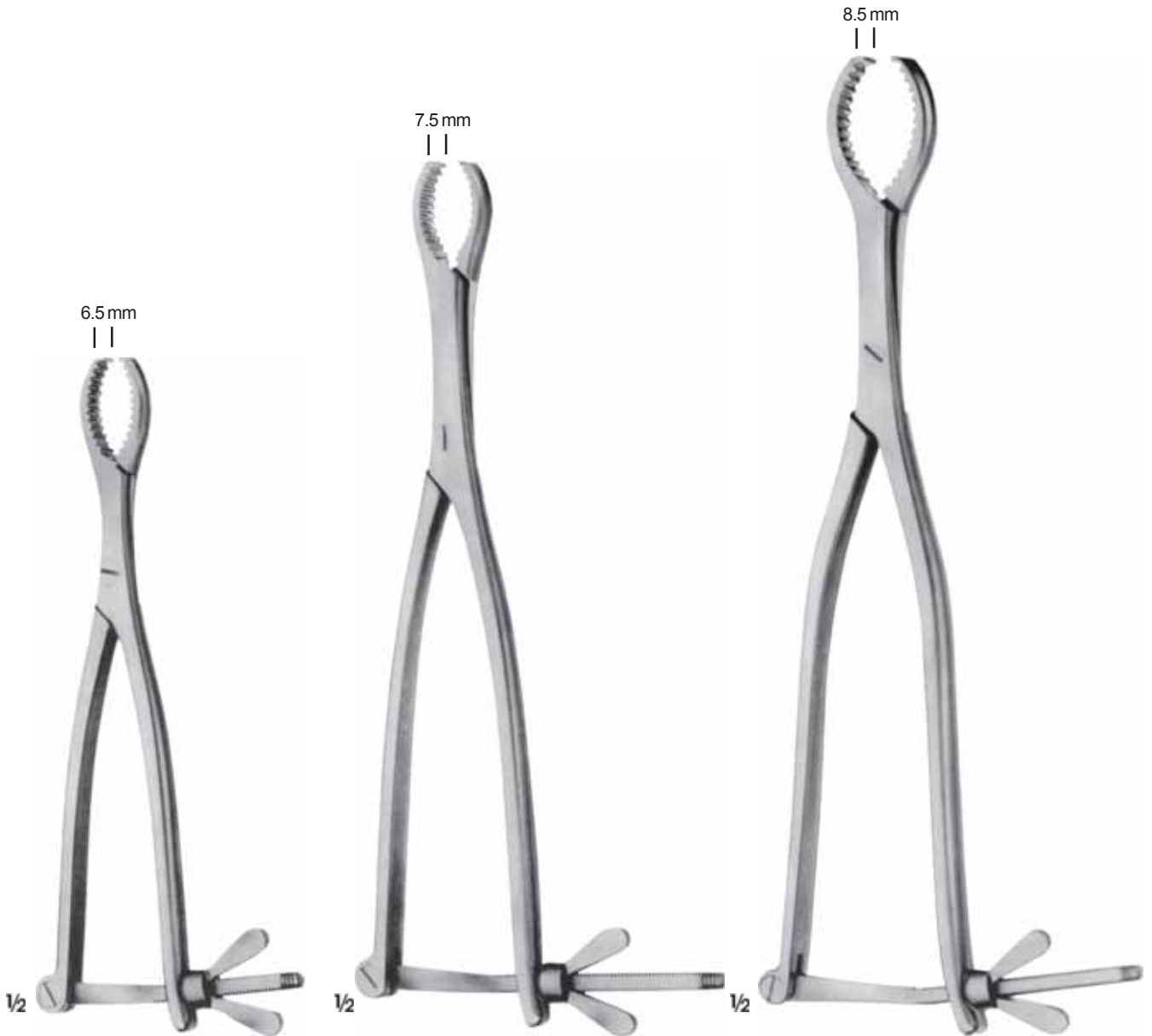

HEY GROVES
P 163.00
21 cm

HEY GROVES
P 163.01
27 cm

HEY GROVES
P 163.02
30.5 cm

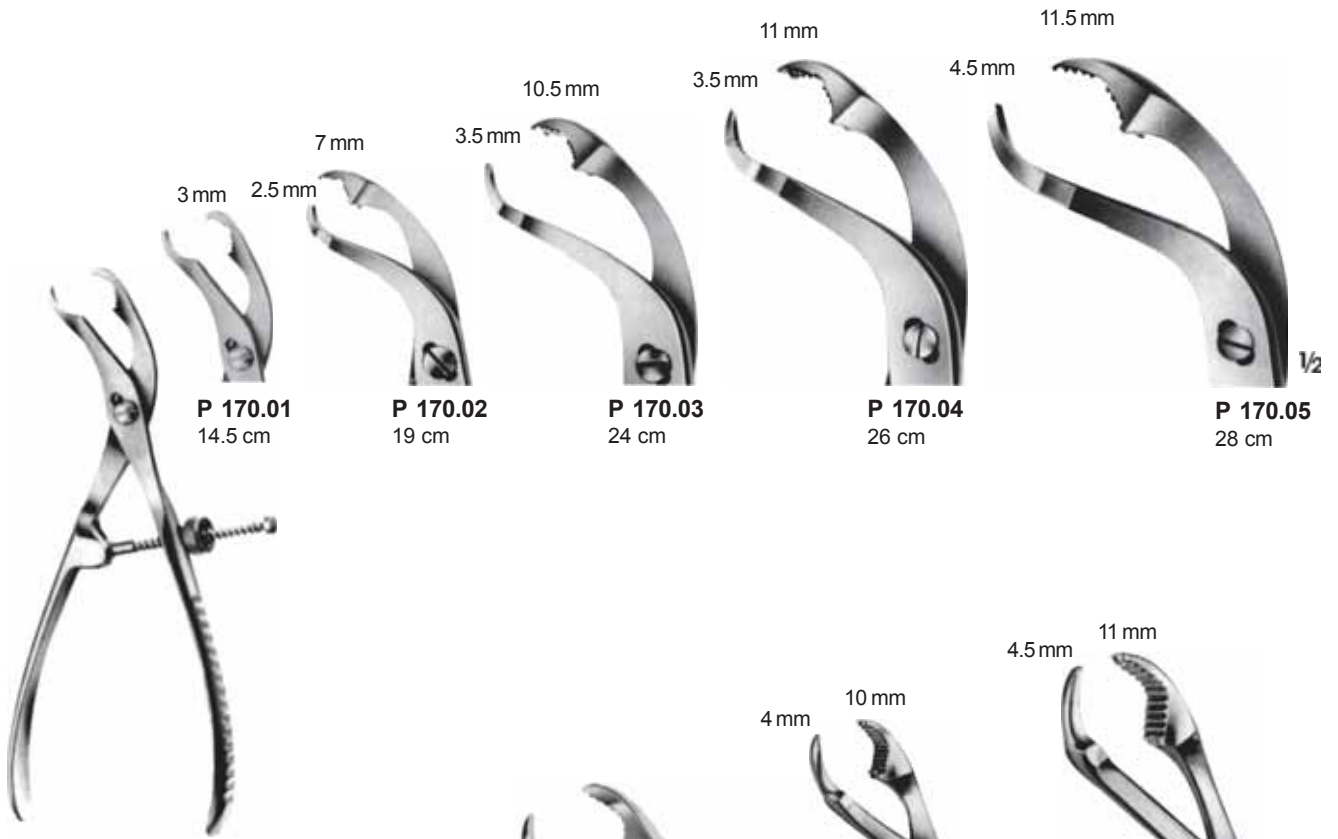

P 170.01 - P 170.05

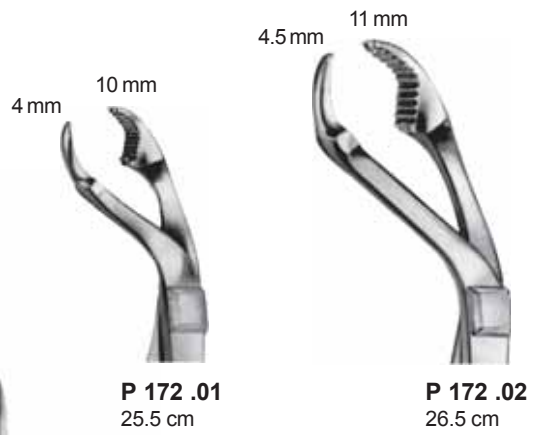

P 172 .01
25.5 cm

P 172 .02
26.5 cm



VERBRUGGE
P 171.00
17.5 cm



P 172 .03
27 cm

VERBRUGGE
P 172.01 - P 172.03

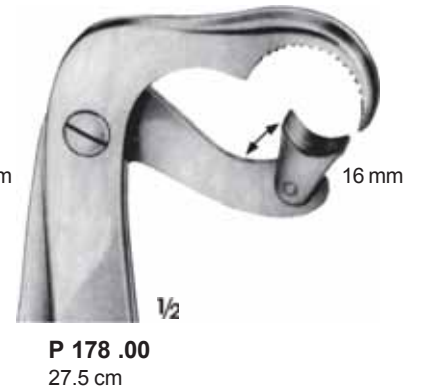



1/2

LOWMAN
P 180.00 17 cm
P 180.01 20.5 cm



1/2

LOWMAN - GERSTER
P 180.02
21 cm



1/2

LOWMAN - HOGLUND
P 183.00
17.5 cm

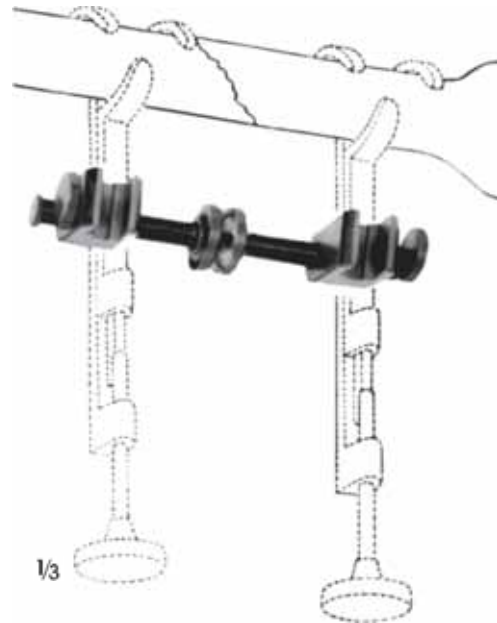

1/3

GERSTER
P 185.00
P 180.00 - P 183.00 için çekirme çubuğu
Traction bar for P 180.00 - P 183.00



P 350.00
13 cm



LISTON
P 358.01-P 358.04



P 358.03
20 cm



P 358.04
22 cm



P 358.01
14 cm



P 358.02
17 cm



P 350.01
17 cm



LISTON
P 359.02-P 359.04



P 359.02
17 cm



P 359.03
20 cm



P 359.04
22 cm



BÖHLER
P 365.00
14.5 cm



BÖHLER
P 366.00
14.5 cm



P 367.00
17 cm



MCINDOE
P 368.00
17.5 cm



RUSKIN - LISTON
P 370.00
19 cm



RUSKIN - LISTON
P 371.00
19 cm

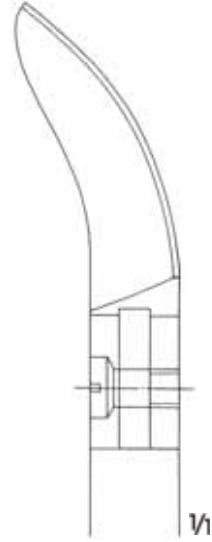
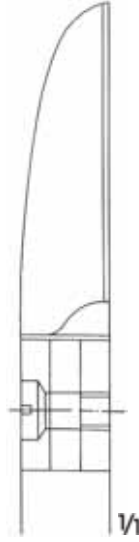
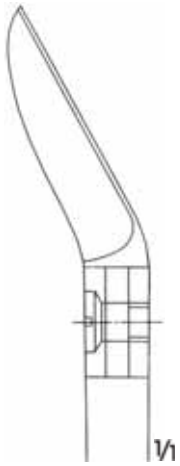

LISTON
P 375.01
24 cm



LISTON
P 376.01
28 cm



LISTON
P 377.01
28 cm

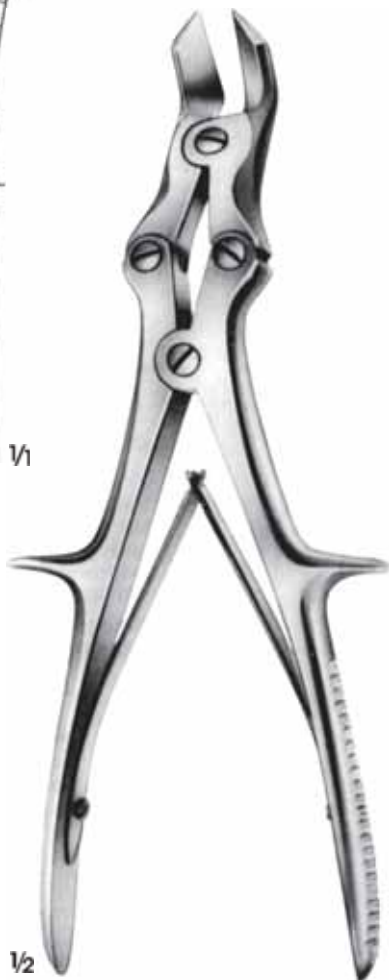
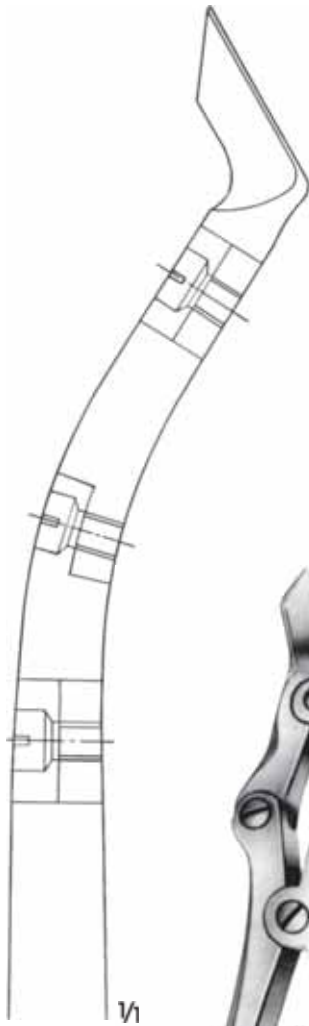

LISTON - KEY - HORSLEY
P 379.01
25.5 cm

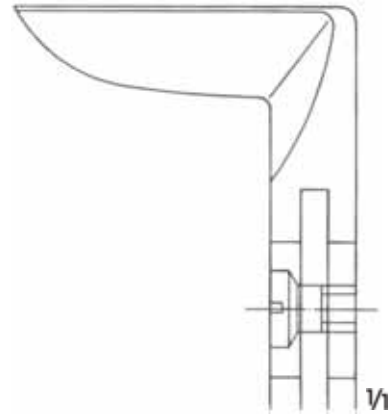

LISTON - STILLE
P 378.01
26.5 cm

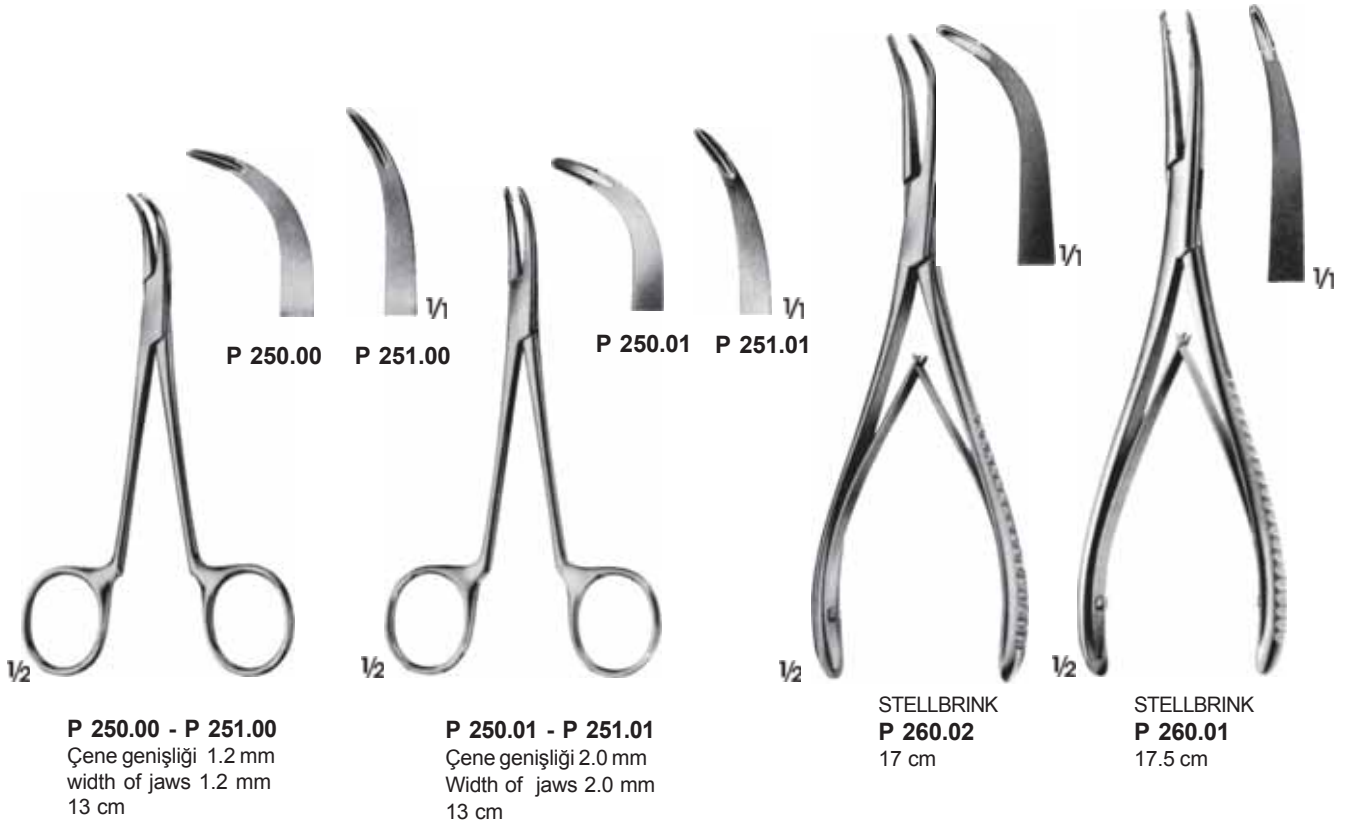

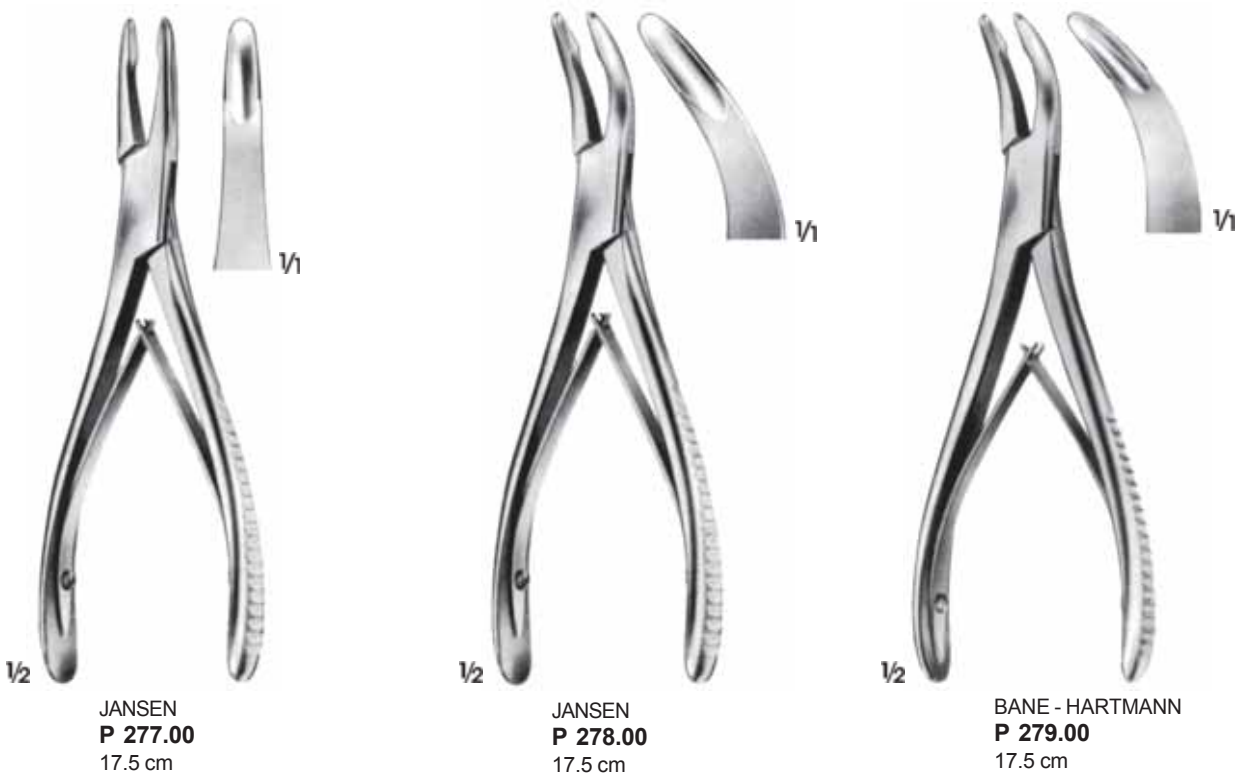
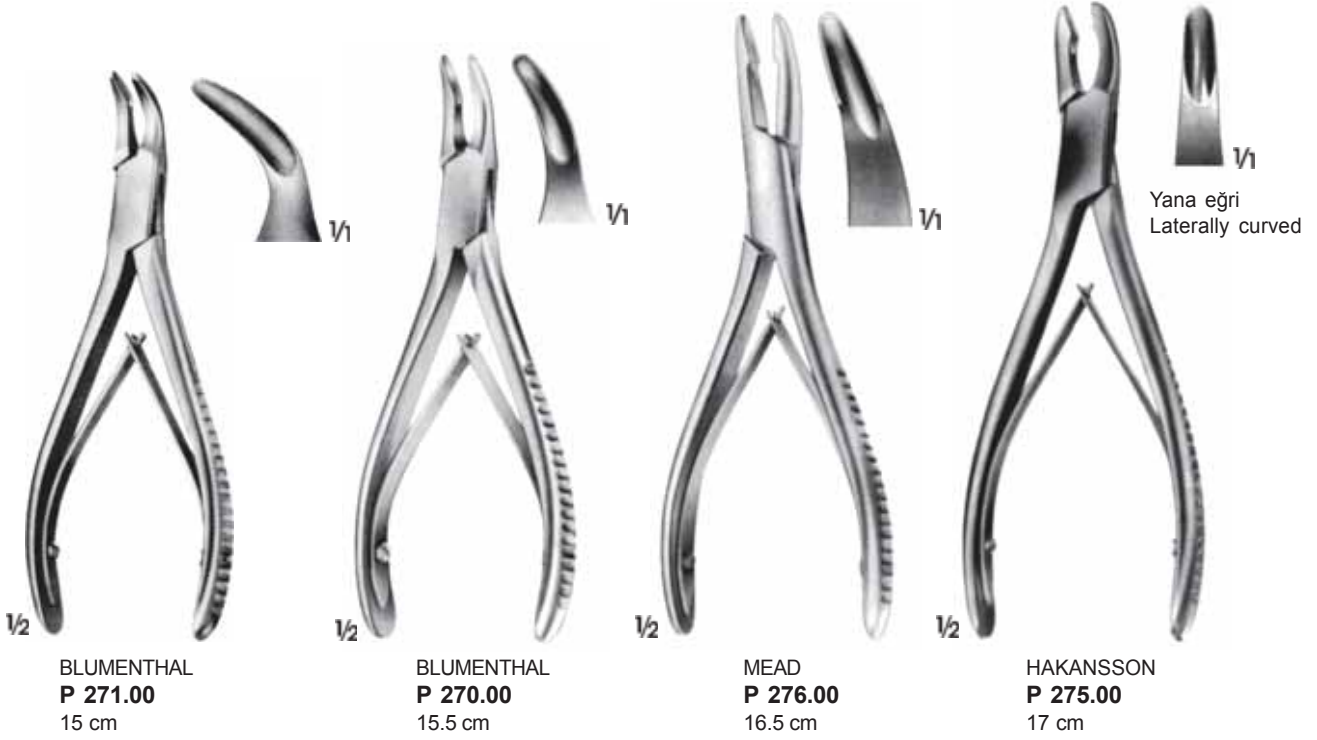

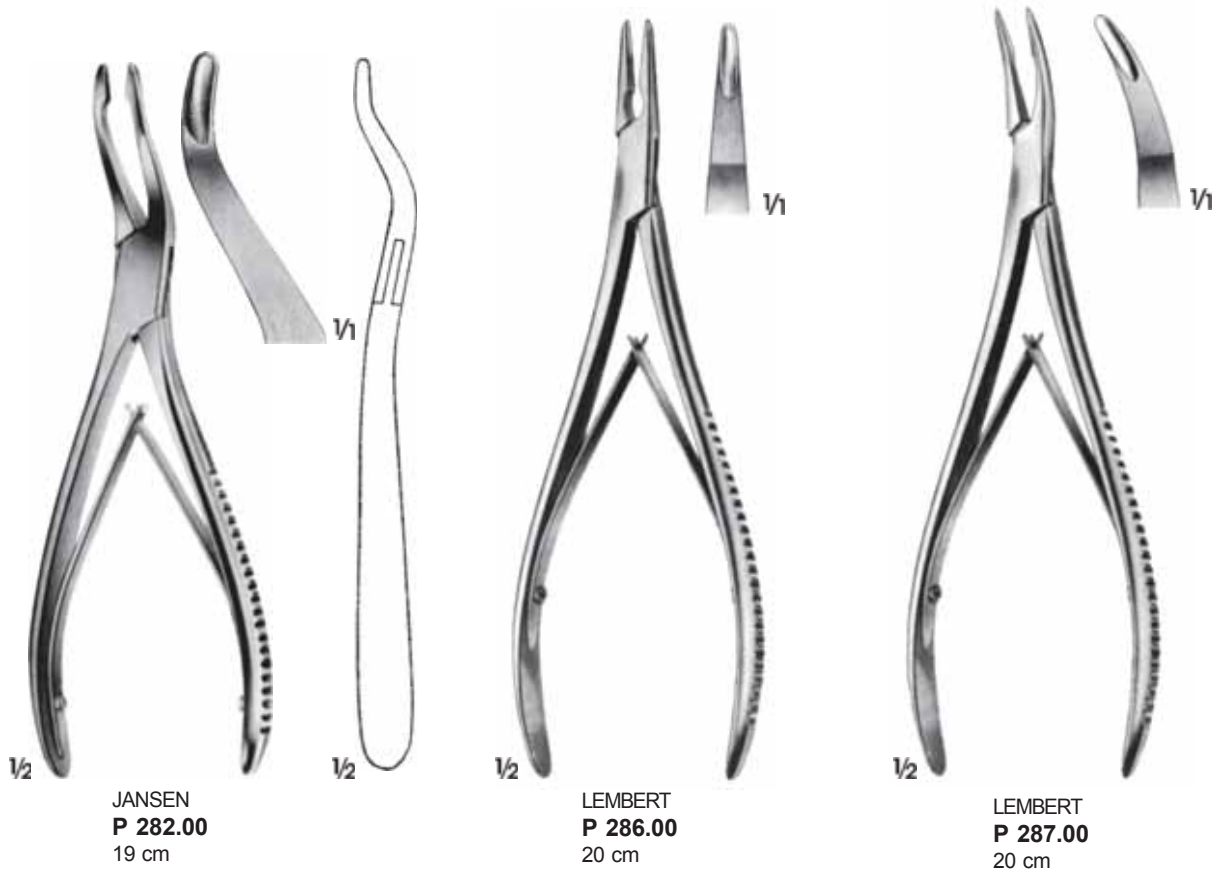
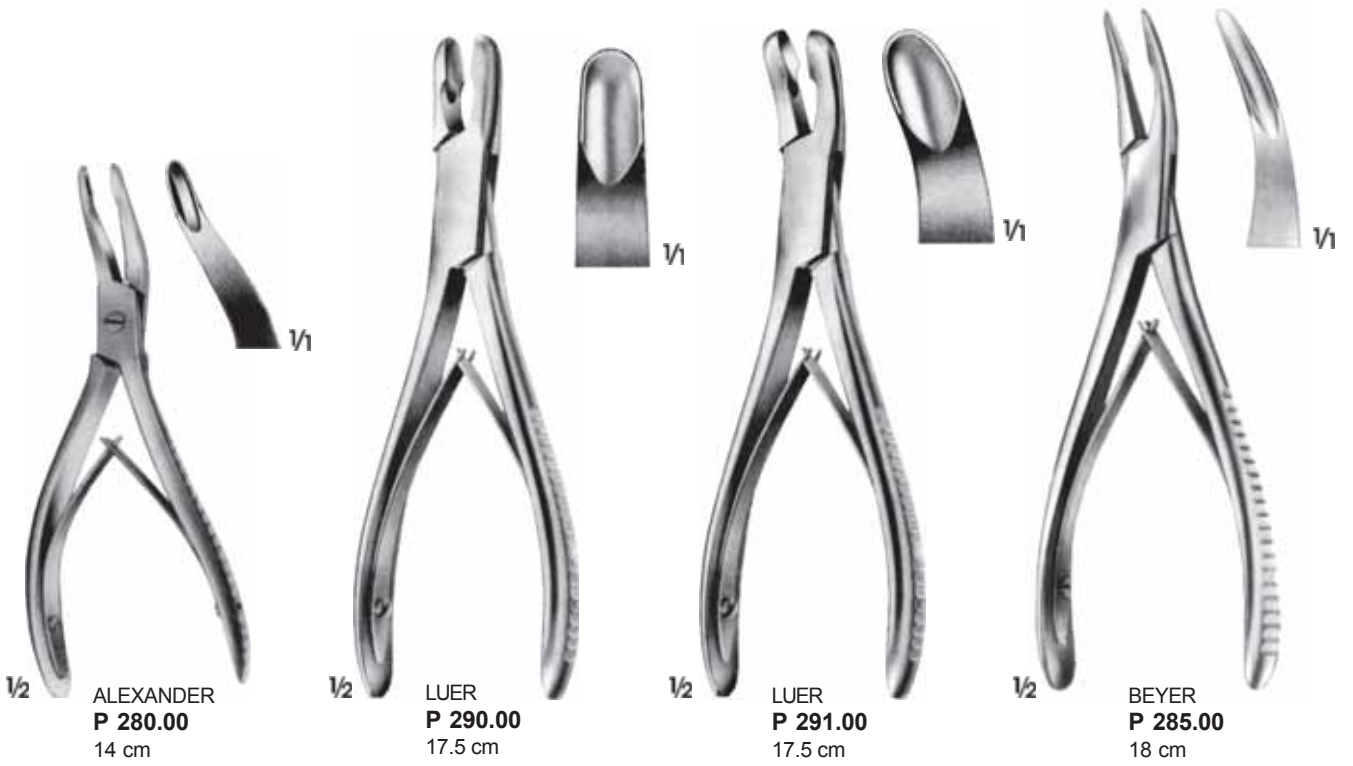



MEAD
P 293.00
16.5 cm



LUER
P 295.00
18 cm



LUER
P 296.00
18 cm



OLIVECRONA
P 297.00
20.5 cm



GULEKE
P 298.00
20.5 cm





MARKWALDER
P 330.00
19 cm



1/2 ECHLIN
P 310.01 - P 310.02
23 cm



1/2 STILLE
P 315.01
23.5 cm



1/2 LEKSELL - STILLE
P 316.01
24 cm



1/2 STILLE - RUSKIN
P 318.01
24 cm



1/2 FRYKHOLM
P 312.00
24 cm





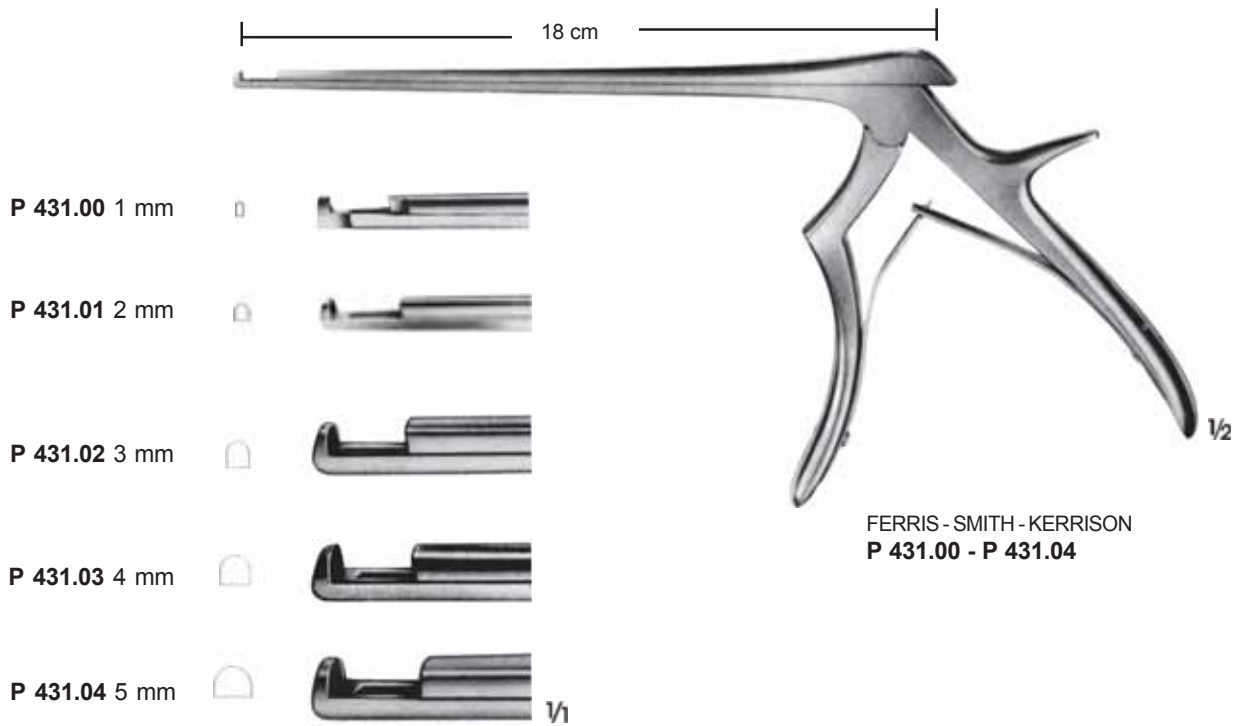
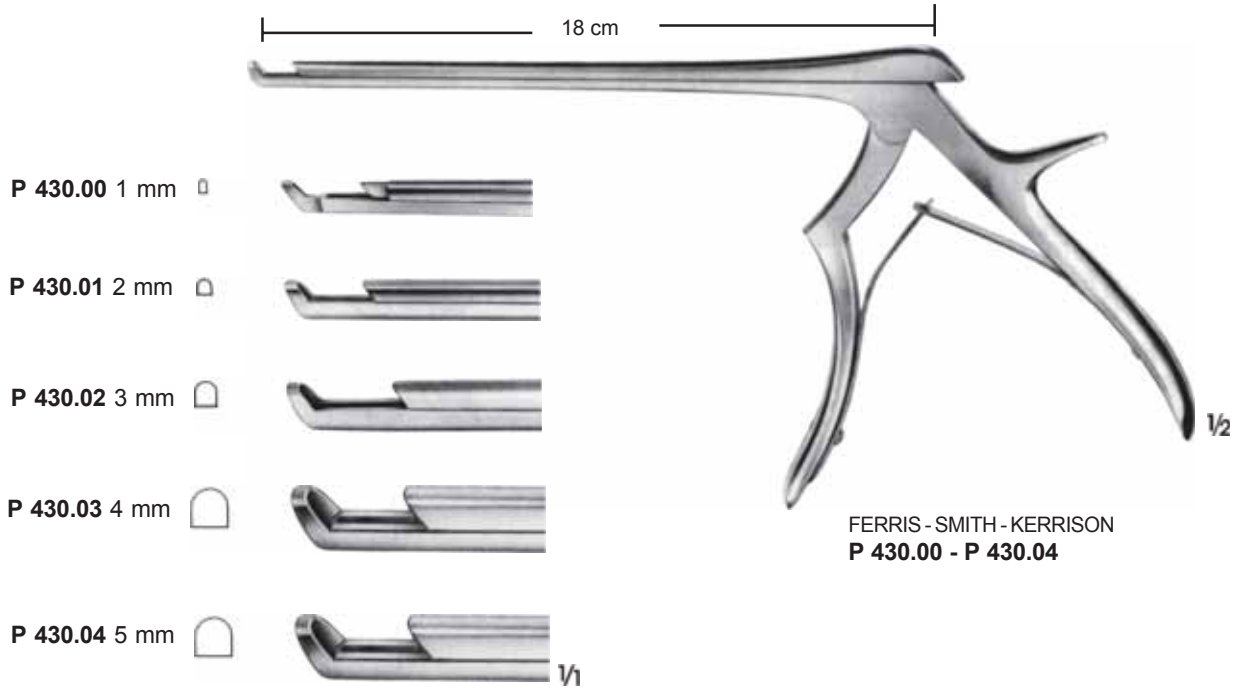

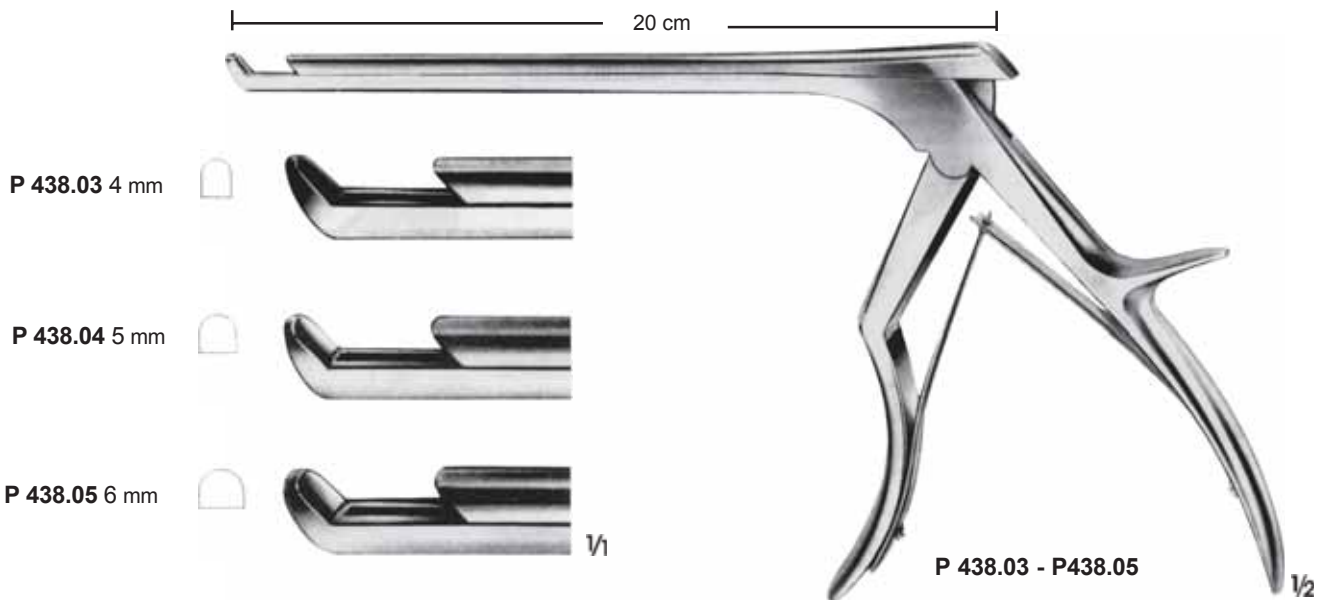
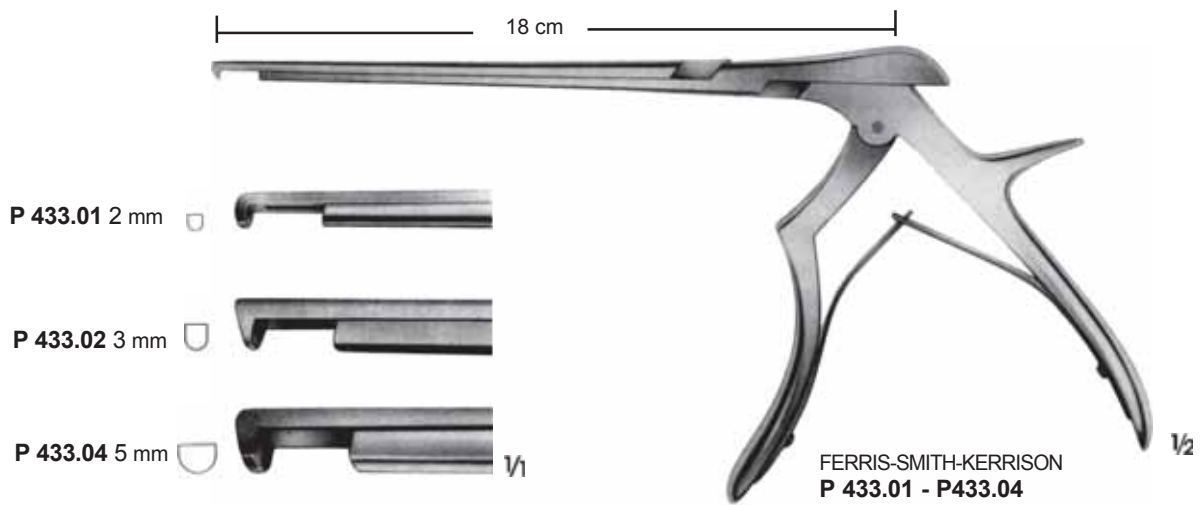
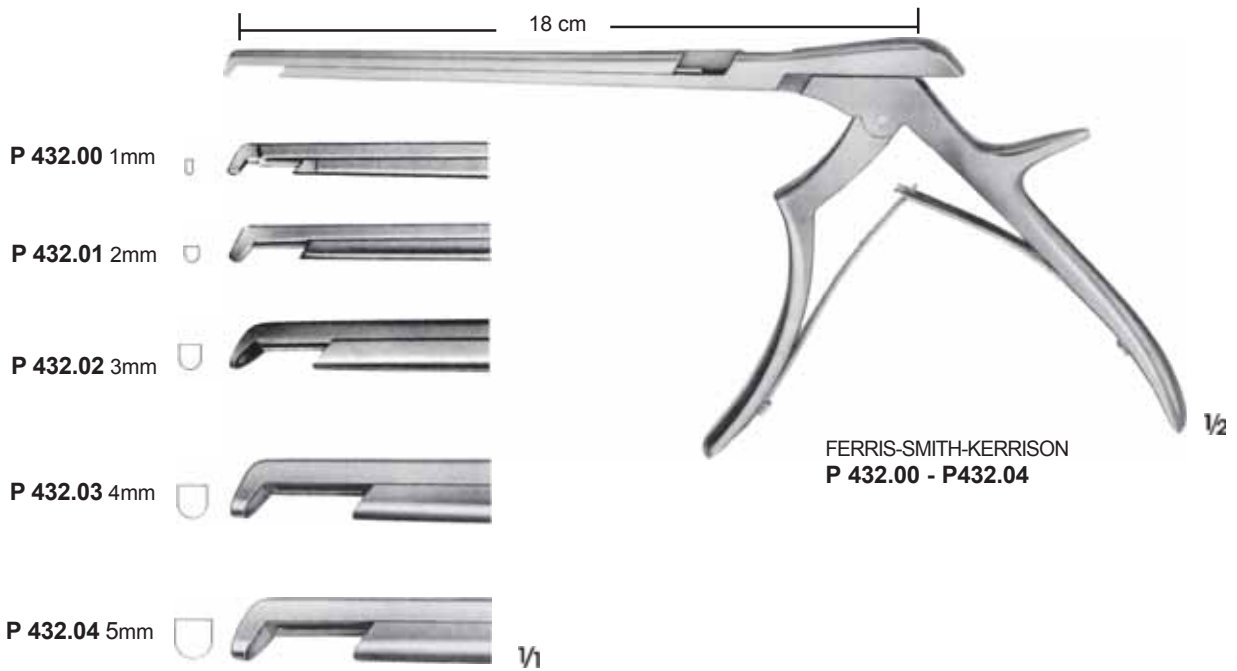

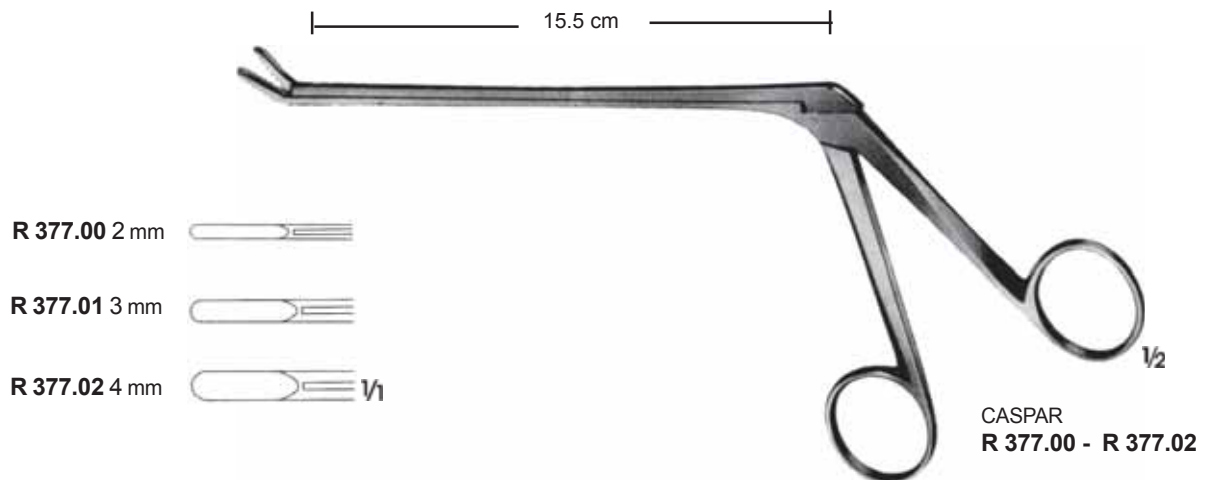
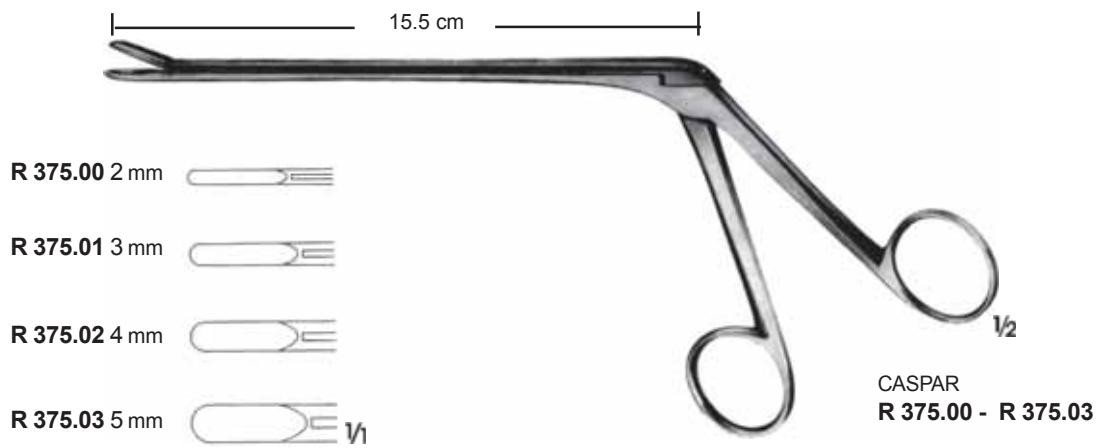
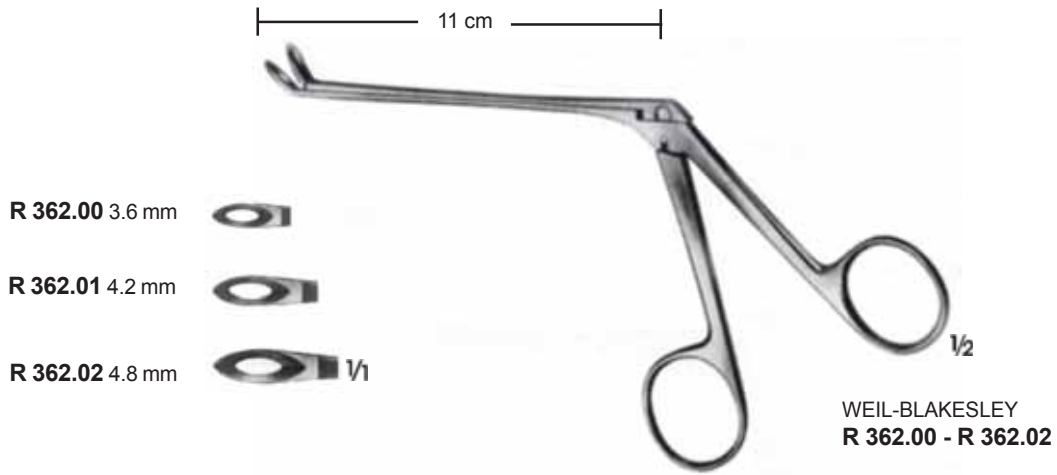







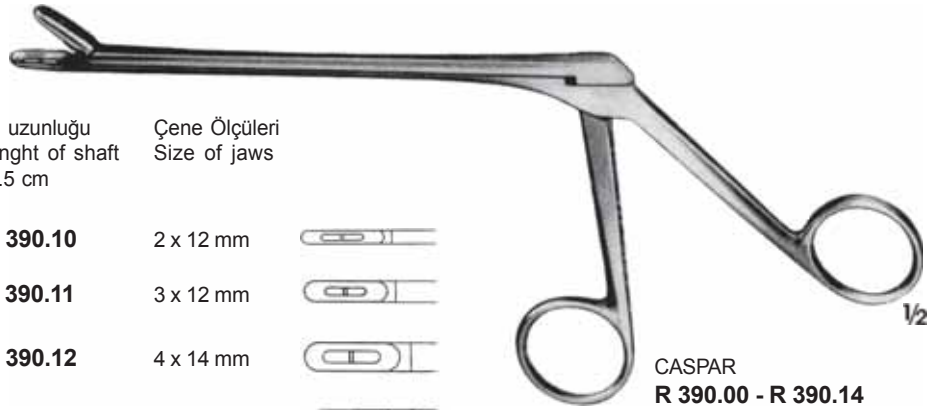

- R 379.00** 2 mm 
- R 379.01** 3 mm 
- R 379.02** 4 mm 



CASPAR
R 379.00 - R 379.02

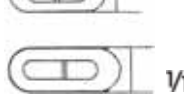

Mil uzunluğu Lenght of shaft 14 cm	Mil uzunluğu Lenght of shaft 16 cm	Mil uzunluğu Lenght of shaft 18.5 cm	Çene Ölçüleri Size of jaws	
R 390.00	R 390.05	R 390.10	2 x 12 mm	
R 390.01	R 390.06	R 390.11	3 x 12 mm	
R 390.02	R 390.07	R 390.12	4 x 14 mm	
R 390.03	R 390.08	R 390.13	5 x 14 mm	
R 390.04	R 390.09	R 390.14	6 x 16 mm	

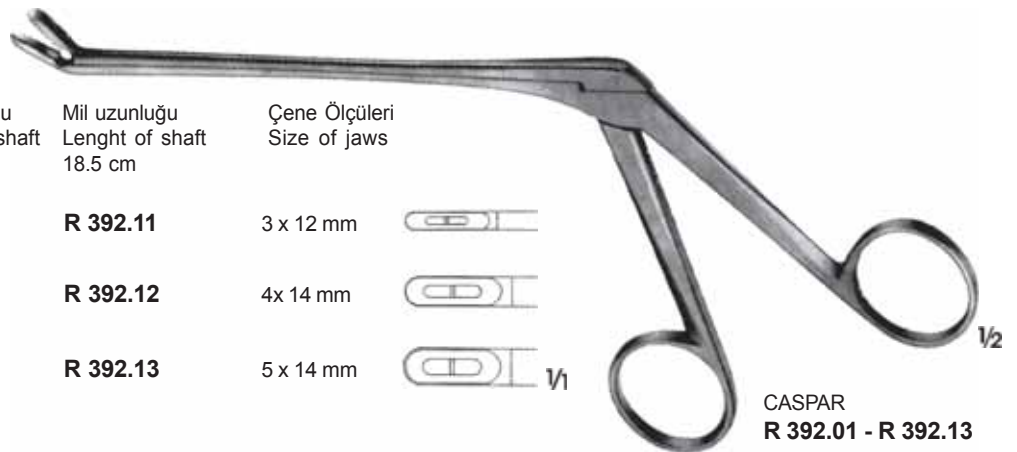
CASPAR
R 390.00 - R 390.14



Mil uzunluğu Lenght of shaft 14 cm	Mil uzunluğu Lenght of shaft 16 cm	Mil uzunluğu Lenght of shaft 18.5 cm	Çene Ölçüleri Size of jaws	
R 392.01	R 392.06	R 392.11	3 x 12 mm	
R 392.02	R 392.07	R 392.12	4x 14 mm	
R 392.03	R 392.08	R 392.13	5 x 14 mm	

CASPAR
R 392.01 - R 392.13

Mil uzunluđu
Lenght of shaft
14 cm

R 394.01

Mil uzunluđu
Lenght of shaft
16 cm

R 394.06

Mil uzunluđu
Lenght of shaft
18.5 cm

R 394.11

Çene Ölçüleri
Size of jaws

3 x 12 mm



R 394.02

R 394.07

R 394.12

4x 14 mm

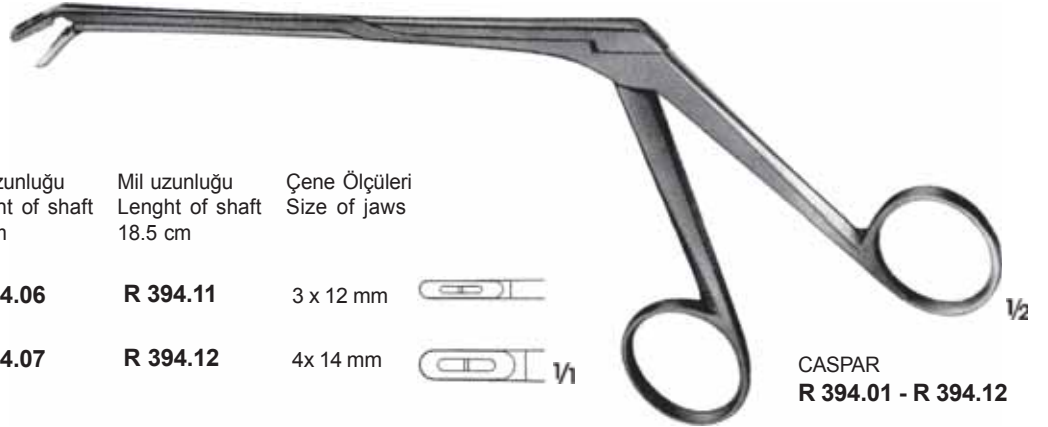

CASPAR
R 394.01 - R 394.12

21 cm

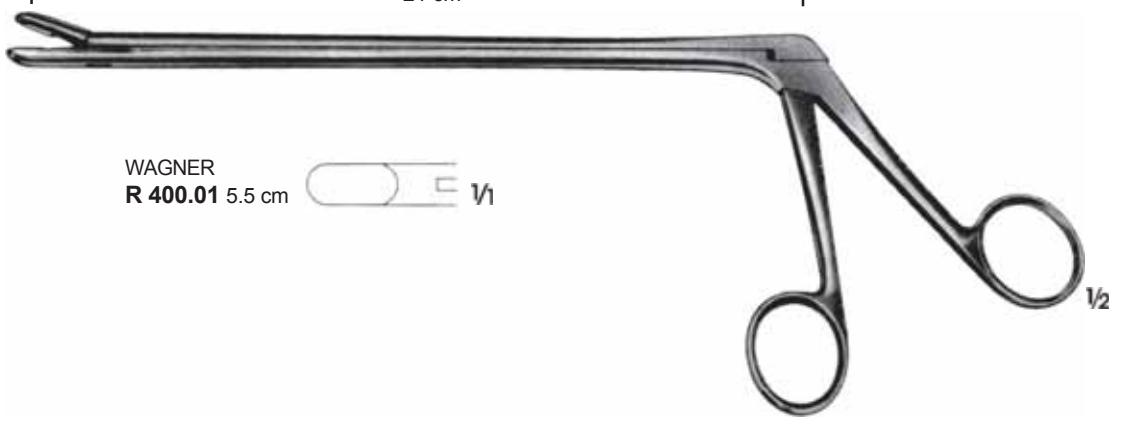

WAGNER
R 400.01 5.5 cm



14 cm

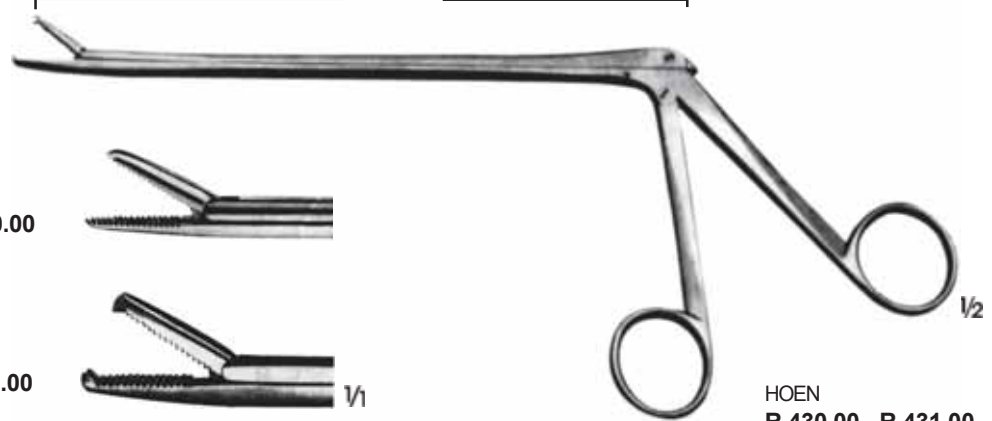

HOEN
R 430.00



R 431.00





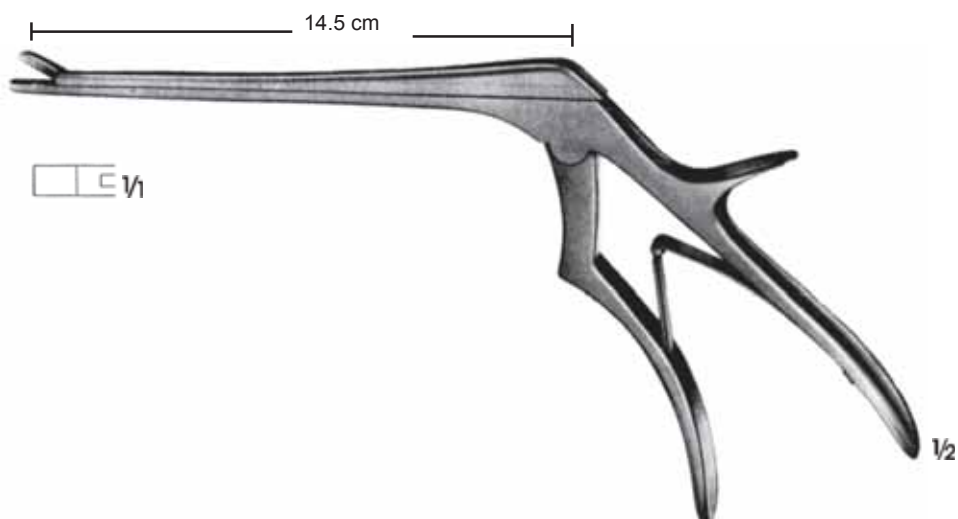

HOEN
R 430.00 - R 431.00

KRAMER
R 432.00 15 cm





- | | | | |
|----------|----------|------|---|
| R 456.01 | R 455.00 | 3 mm |  |
| R 456.02 | R 455.04 | 4 mm |  |
| R 456.03 | — | 5 mm |  |
| | R 455.06 | 6 mm |  1/1 |

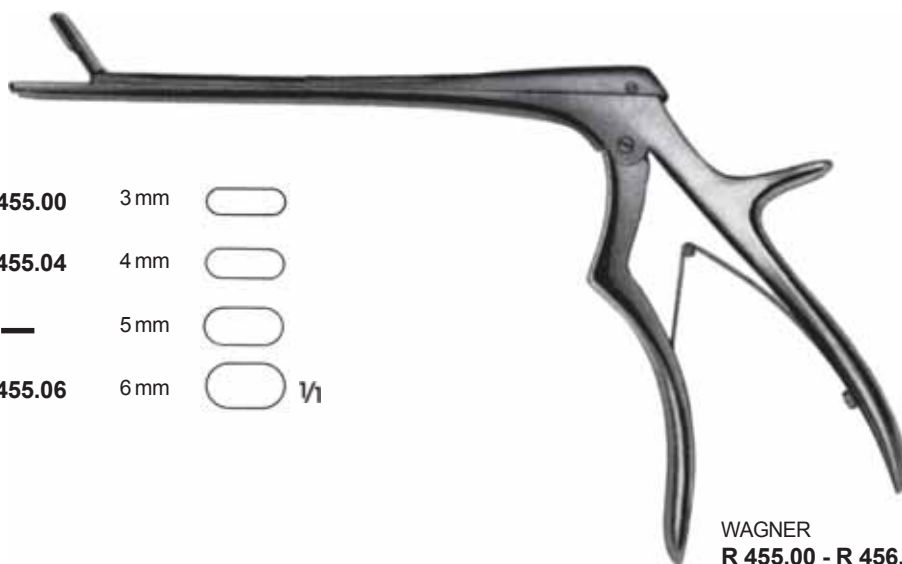

WAGNER
R 455.01 5.5 mm

 1/1

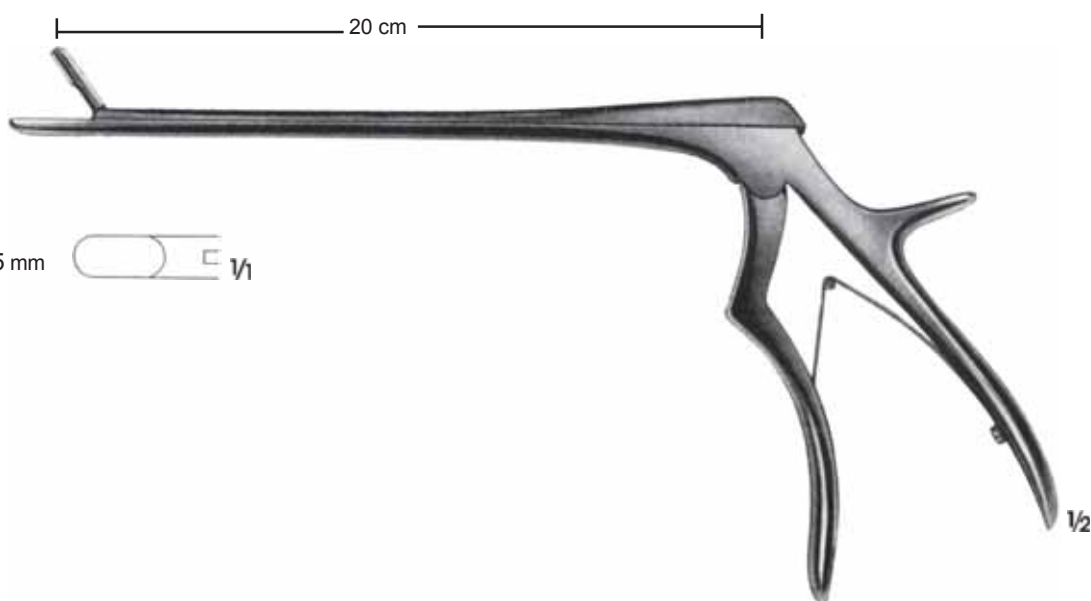



CRUTCHFIELD
S 500.00
Küçük boy /Small size



CRUTCHFIELD
S 500.02
Orta boy /Medium size



GARDNER - WELS
S 510.00
Maksimum açıklık (16 cm)
Maximum Opening (16 cm)



S 505.10
Anahtar / Wrench



S 500.03
Ø 3.5 mm



S 500.04
Ø 5 mm



S 502.03
S 502.01 için matkap ucu
Drill points for S 502.01



16 cm

HINZ
S 502.01



S 505.01
Pimleri ayarlanabilir büyük boy
Traksiyon, anahtar ile
Large size Traction tongs with
adjustable pins and spanner
S 505.10

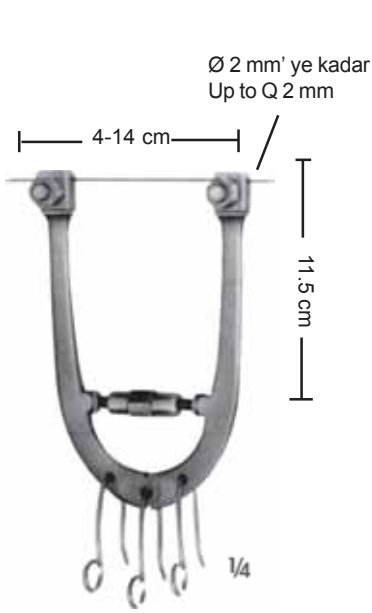

S 550.00

Ayarlı küçük boy ,üç kancalı traksiyon aleti
Wire traction bow ,adjustable , with 3 hooks,
small size

S 558.00 Uygun anahtar
S 558.00 Suitable wrench

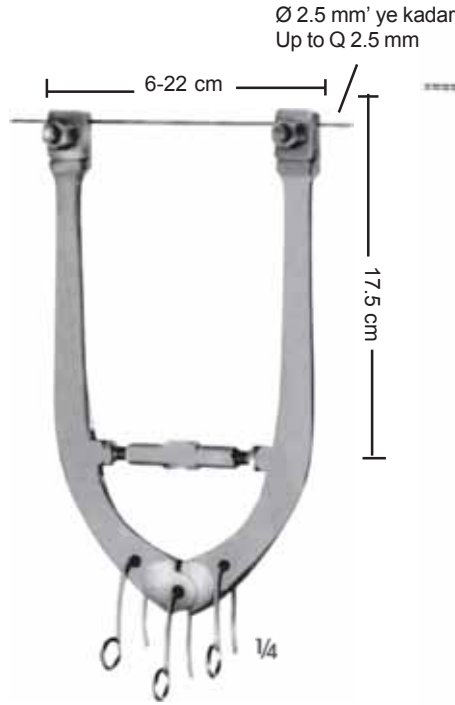

S 550.01

Ayarlı büyük boy ,üç kancalı traksiyon aleti
Wire traction bow ,adjustable , with 3 hooks,
large size

S 558.00 Uygun anahtar
S 558.00 Suitable wrench



S 556.01 18 x 10 cm
S 556.03 27 x 16 cm

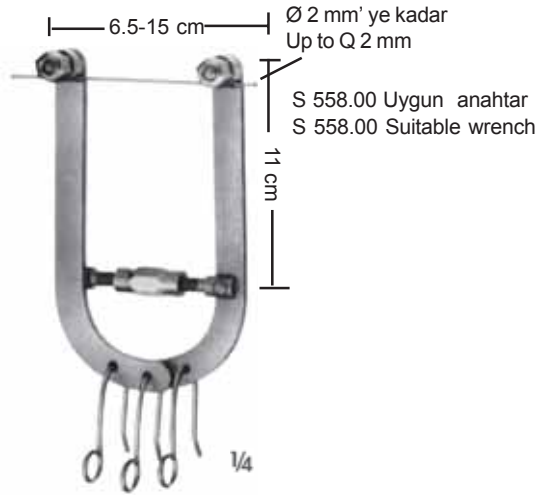

S 551.00

Ayarlı küçük boy ,üç kancalı traksiyon aleti
Wire traction bow ,adjustable , with 3 hooks,
small size



Ø 4 mm STEINMANN çivileri için
For Ø 4 mm STEINMANN Pins
Kol ölçüleri / Arms dimensions
S 560.01 16 x 9 cm
S 560.03 21 x 11 cm
S 560.05 21 x 15 cm
STEINMANN çivileri hariç
Except for STEINMANN pins

Ø 5 mm STEINMANN çivileri için
For Ø 5 mm STEINMANN Pins
Kol ölçüleri / Arms dimensions
S 560.07 16 x 9 cm
S 560.08 21 x 15 cm
STEINMANN çivileri hariç
Except for STEINMANN pins



S 557.00

Sabitleme diski kanallı



S 557.01

Alüminyum ,x ışınlarını geçiren



S 557.02

Sabitleme diski kanallı



S 557.03

Sabitleme diskleri için
tornavida



KIRSCHNER

S 552.00 - S 552.06

3 kancalı, Ø 2.5 mm'ye kadar KIRSCHNER teli ile kullanılan çekirme

Wire traction bows, to be used with KIRSCHNER wires up to Ø 2.5 mm diam ,with 3 hooks



S 552.10

Kavrama çeneli tel gerdirme aleti
Wire tightener , with clamping jaws

İç Ölçüler
Inside dimensions

End Witdh	Derinlik Depth	
S 552.00 20 cm	15.5 cm	Kalça için / For the hip
S 552.01 15.5 cm	15.5 cm	Femur için / For the femur
S 552.02 13.5 cm	13 cm	Diz için / For the knee
S 552.03 12 cm	12 cm	Diz için / For the knee
S 552.04 10.5 cm	10 cm	Diz için / For the knee
S 552.05 9.5 cm	11 cm	Topuk için / For the calcaneus
S 552.06 9.5 cm	7 cm	Kol ve dirsek için / For the arm and elbow
S 552.08 6 cm	5 cm	Dirsek için, çocuklar için / For the elbow child size



S 552.12

S 552.10 Tespit klempini için
S 552.10 For fixation clamp

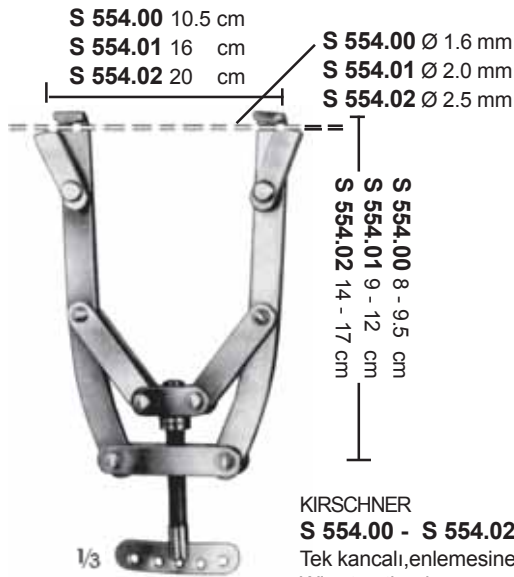

KIRSCHNER

S 554.00 - S 554.02

Tek kancalı, enlemesine yaylı Traksiyon aleti
Wire traction bows, modified , adjustable in width , holds wire securely , with 1 hook



S 555.00

Büyük boy traksiyon kancası
Large size Traction hook



S 555.01

Küçük boy traksiyon kancası
Small size Traction hook



S 558.00

Traksiyon yayı anahtarı
Wrench ,double - ended, for wire traction bows S 552.00 - S 551.00



T 792.00 1 kg

T 792.01 2 kg

T 792.02 5 kg

Ağırlık / Weight

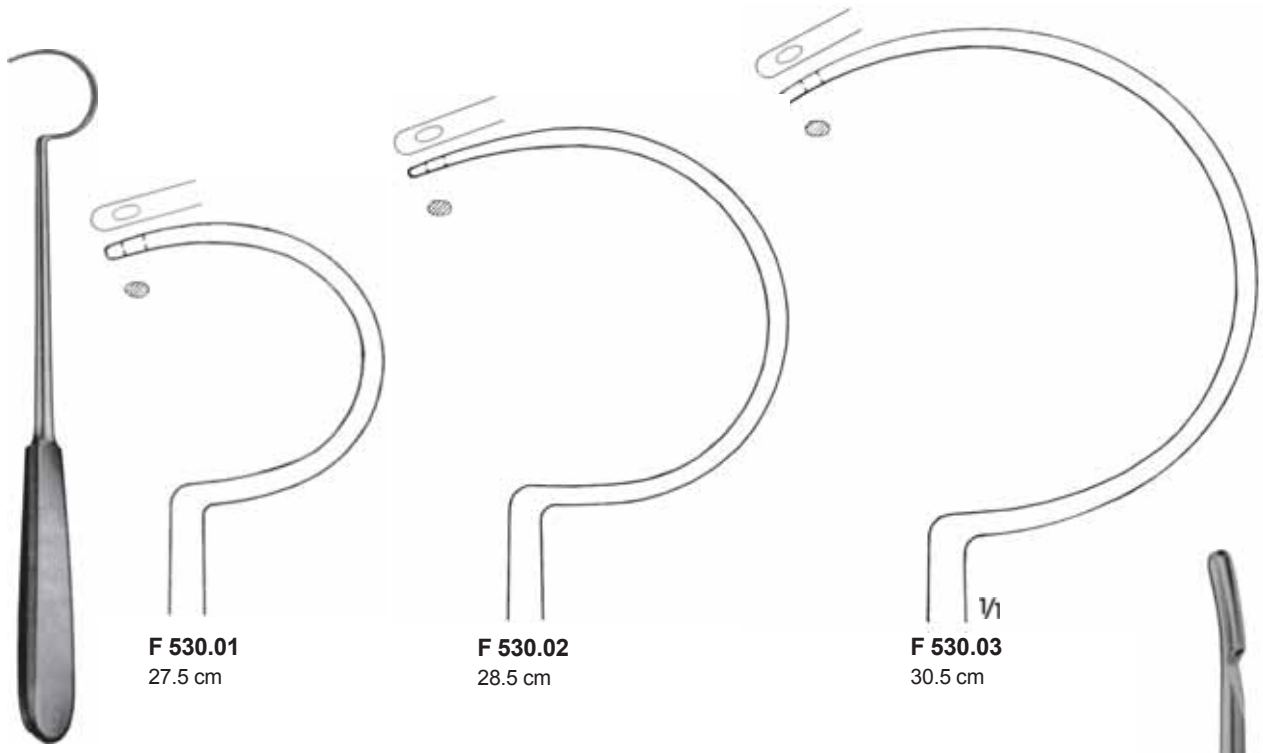

F 530.01
27.5 cm

F 530.02
28.5 cm

F 530.03
30.5 cm

DEMEL
F 530.01 - F 530.03
Tel kılavuzları / Wire guides

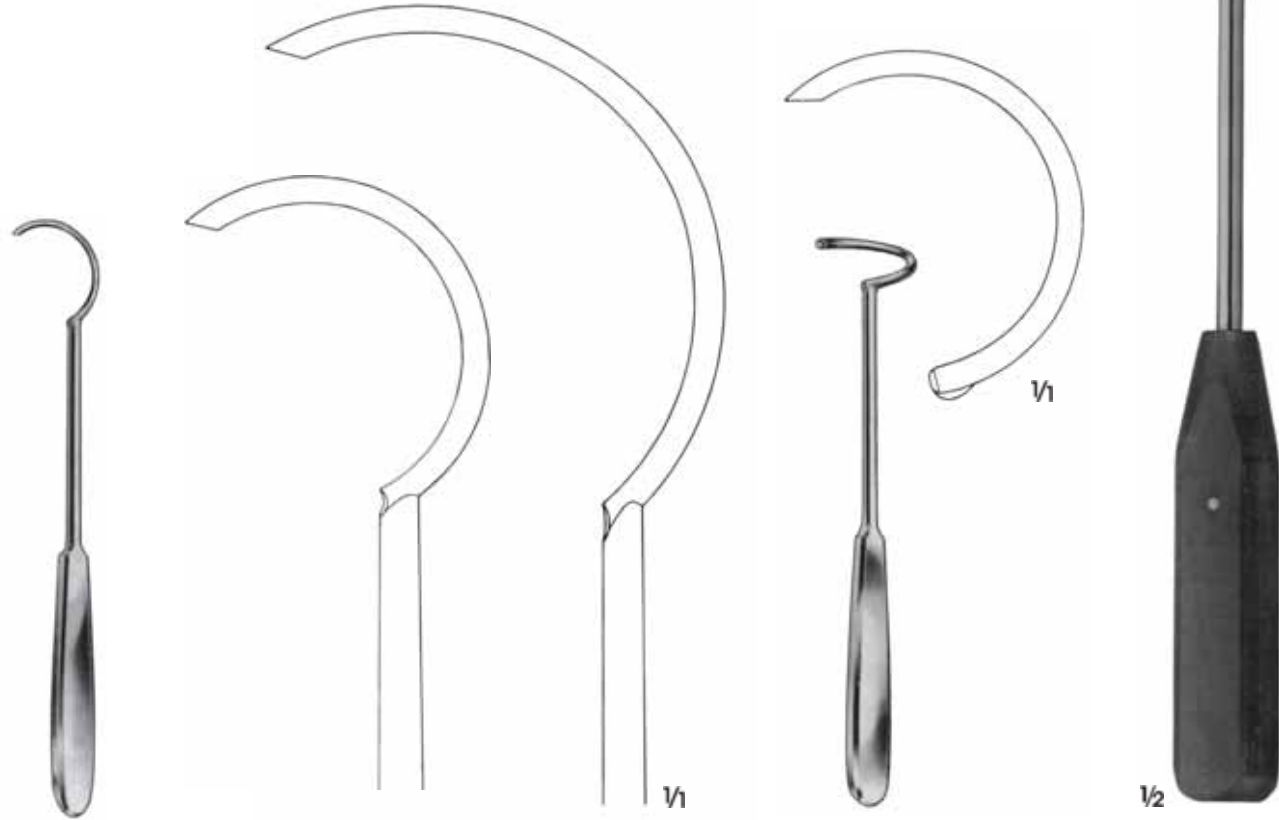

F 531.01
24 cm

F 531.03
27 cm

F 532.01
22.5 cm

WAGNER
F 533.00
30 cm



F 529.00 - F 529.10
Yumuşak tel / Wire soft

- | | | | |
|--------------------------|--------------------------|--------------------------|--------------------------|
| F 529.00 Ø 0.2 mm | F 529.03 Ø 0.5 mm | F 529.06 Ø 0.8 mm | F 529.09 Ø 1.2 mm |
| F 529.01 Ø 0.3 mm | F 529.04 Ø 0.6 mm | F 529.07 Ø 0.9 mm | F 529.10 Ø 1.5 mm |
| F 529.02 Ø 0.4 mm | F 529.05 Ø 0.7 mm | F 529.08 Ø 1.0 mm | |

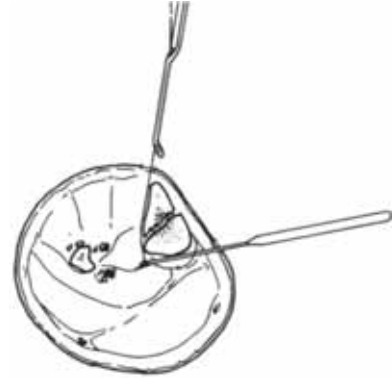

LOUTE
F 520.00
Tel sıkma aparatı Ø 1.0 mm
Wire tightener, 1.0 mm diam
22 cm



DEMEL
F 522.00
27 cm



JORDAN F 525.00 17 cm	JORDAN F 527.00 17 cm	JORDAN F 526.00 18 cm
---	---	---

Sert Metal Ağızlı / Hard Metal Edges



F 334.00
15 cm



F 336.00
15 cm



BAUMGARTNER
F 339.01
20 cm



F 337.01
17.5 cm



P 610.00
17 cm



P 639.00 Ø 9 mm
17 cm



P 611.00
14 cm



P 612.00 - P 613.00
17 cm



P 614.00
19 cm



P 615.00 - P 616.00



13 cm



P 616.00
18 cm



P 618.01 - P 618.05



P 618.01
18 cm



P 618.05
14.5 cm



P 618.02
18 cm



P 618.03
18 cm



P 620.00 Ø 1.8 mm



P 621.00
18.5 cm



1/1



P 625.00
20 cm



1/1

Sert Metal Ağız / Hard Metal Edged



ANGEL
P 630.00 12 cm
P 630.01 13 cm

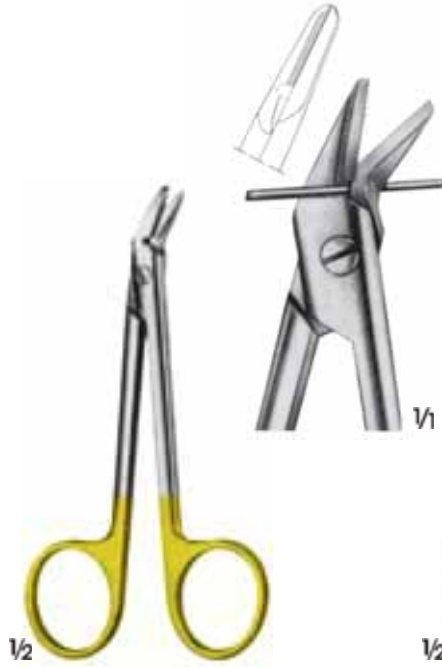

C 798.00
Tek ağız tırtıllı
One jaw serrated
12 cm

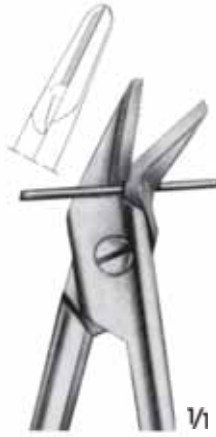

C 796.00
Çift ağız tırtıllı
Both jaws serrated
12.5 cm

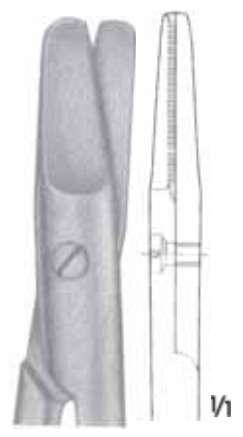

P 632.00
14 cm



P 635.00
15 cm

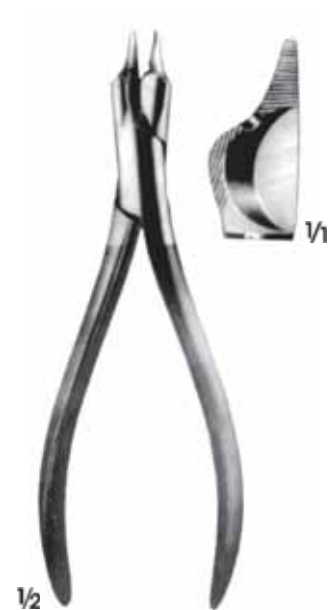

P 634.00
16 cm



Sert Metal Ağız / Hard Metal Edged



Yumuşak tel için Ø 2.0 mm
For soft wire Ø 2.0 mm
Sert tel için Ø 1.6 mm
For hard wire Ø 1.6 mm

REILL
P 640.00
17.5 cm

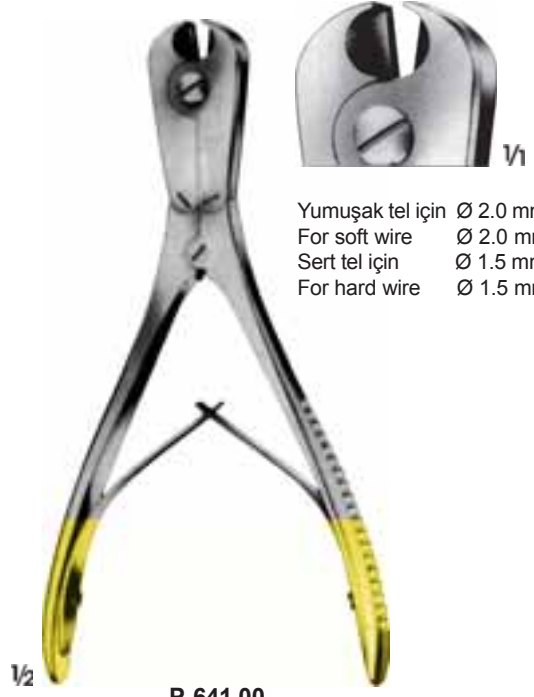

Yumuşak tel için Ø 2.0 mm
For soft wire Ø 2.0 mm
Sert tel için Ø 1.5 mm
For hard wire Ø 1.5 mm

P 641.00
18 cm



Yumuşak tel için Ø 3.0 mm
For soft wire Ø 3.0 mm
Sert tel için Ø 2.2 mm
For hard wire Ø 2.2 mm

P 643.00
23.5 cm

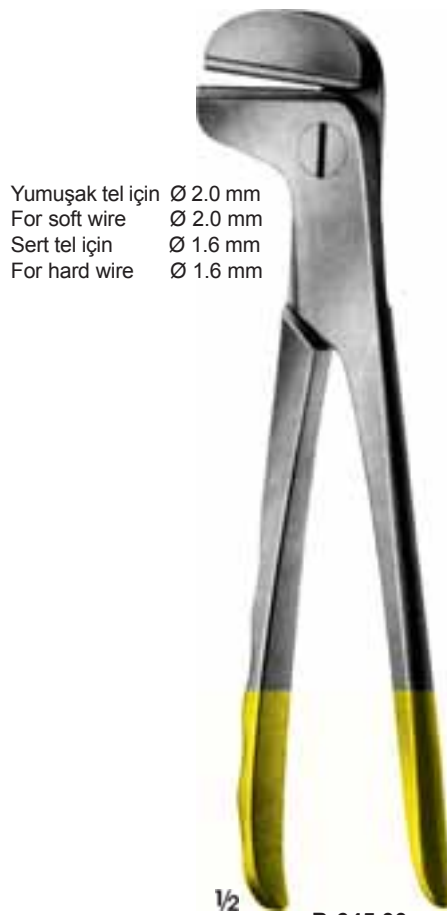

Yumuşak tel için Ø 2.0 mm
For soft wire Ø 2.0 mm
Sert tel için Ø 1.6 mm
For hard wire Ø 1.6 mm

P 645.00
24 cm

Sert Metal Ağız / Hard Metal Edged



1/2

P 647.00
14.5 cm

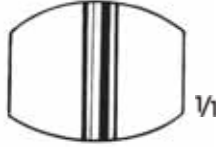

1/1

Yumuşak tel için Ø 2.0 mm
For soft wire Ø 2.0 mm
Sert tel için Ø 1.5 mm
For hard wire Ø 1.5 mm



1/2

P 650.00
14.5 cm



1/1

Yumuşak tel için Ø 1.5 mm
For soft wire Ø 1.5 mm
Sert tel için Ø 1.0 mm
For hard wire Ø 1.0 mm



1/2

P 648.00
22 cm



1/2

Yumuşak tel için Ø 3.5 mm
For soft wire Ø 3.5 mm
Sert tel için Ø 2.5 mm
For hard wire Ø 2.5 mm



Yumuşak tel için Ø 3.0 mm
For soft wire Ø 3.0 mm
Sert tel için Ø 3.0 mm
For hard wire Ø 3.0 mm

1/3

P 652.00
32 cm



P 655.00

Ø 6 mm kadar tel,vida,çivi vs.kesmek için

For cutting off wires,screws,pins,etc. up to Ø 6 mm
47 cm



$\frac{1}{2}$
ENGEL
T 605.00
16 cm



$\frac{1}{2}$
ESMARCH
B 175.00
18 cm



$\frac{1}{2}$
REINER
B 176.00
18.5 cm



$\frac{1}{2}$
HOPKINS
B 177.00
20 cm



$\frac{1}{2}$
B 179.00
21 cm



$\frac{1}{3}$
STILLE
C 880.00
24 cm



$\frac{1}{3}$
STILLE
C 882.00
23 cm



$\frac{1}{3}$
STILLE
C 884.00
26 cm



← Açık Çene
Open Jaw

1/3

STILLE
C 885.00
36 cm



Arkadan Takviyeli Bleydli
Blade With Reinforced Back

1/3

STILLE
C 886.00
37 cm



P 600.00
23 cm



HENNIG
P 602.00
27 cm



WOLFF
P 608.00 18 cm
P 608.02 24 cm



P 605.00
29 cm



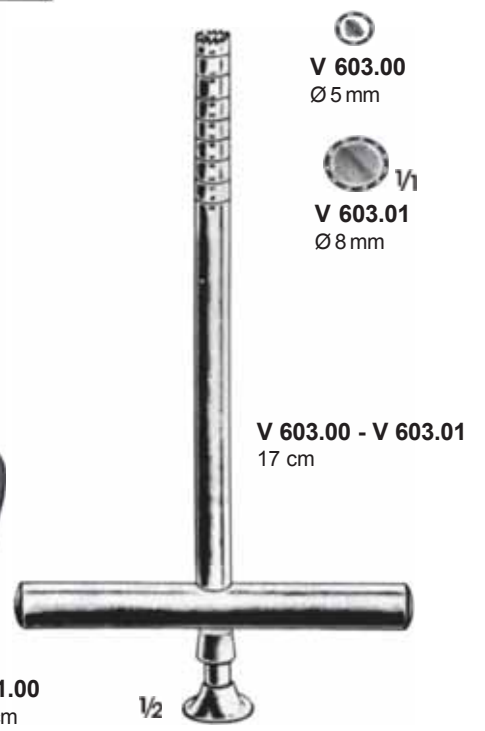
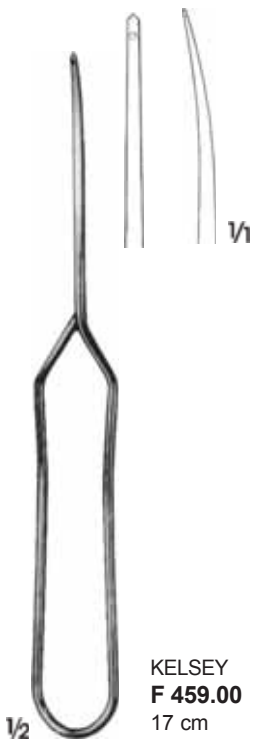



B 161.00

1/2

LANGENBECK
B 160.00 - B 161.00
Ağız uzunluğu
Length of Blade
5.5 cm



1/2

B 163.00
Ağız uzunluğu
Length of Blade
6.5 cm



1/2

B 144.00
Ağız uzunluğu
Length of Blade
10.5 cm



LISTON
B 146.00 13 cm
B 146.01 16 cm
B 146.02 19 cm
B 146.03 22 cm
Ağız uzunluğu
Length of Blade



1/2

LANGENBECK
B 143.00
Ağız uzunluğu
Length of Blade
12 cm



1/2

B 141.00
Ağız uzunluğu
Length of Blade
11 cm



1/2

CATLIN
B 145.00
Ağız uzunluğu
Length of Blade
16 cm

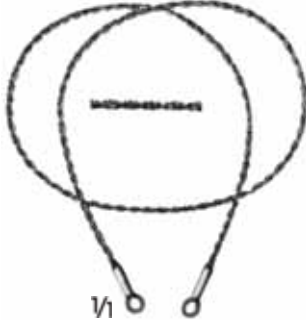

GIGLI
T 536.00 30 cm
T 536.01 40 cm
T 536.02 50 cm
2 Telli/ With 2 wires

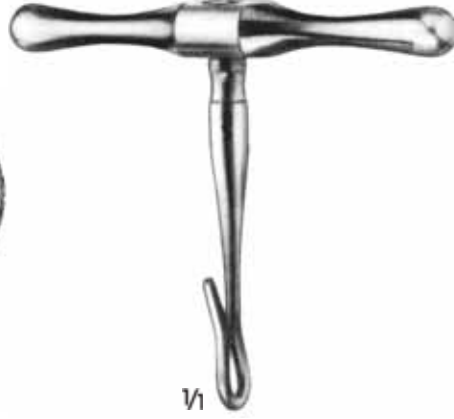

GIGLI
T 530.00
Sap / Handle



GIGLI
T 531.00
Kilitli / With lock



1/2
LEBSCHE
T 255.01
Tel testeresi için klavuz
Conductor for wire saws
Bükülebilir/Malleable
25 cm



1/2
LANGENBECK
T 600.00
23.5 cm

11.5 cm
Bleyd uzunluğu
Length of blade



1/3
SATTERLEE
T 602.00
29 cm

T 602.05 20 cm
Bleyd Uzunluğu
Length of blade



CHARRIERE
T 603.00 27 cm
T 603.02 34 cm

T 603.05 18 cm
T 603.06 24 cm
Bleyd Uzunluğu
Length of blade



CHARRIERE

T 608.00

Sadece sap/Only handle
35 cm

T 608.05 12 mm

T 608.07 18 mm

Bleyd Uzunluđu

Length of Blade

21.5 cm

T 608.10 Komple/Complete

T 608.00 T 608.05 T608.07

1/3



RUST

T 609.10 Komple/Complete

T 609.00, T 609.07, T609.08

T 609.12 Komple/Complete

T 609.00 T 609.05 T609.06

T 609.07 (2 adet/2 each)

T 609.05 6 mm

T 609.06 8 mm

T 609.07 12 mm

T 609.08 18 mm

Bleyd Uzunluđu

Length Blade

23.5 cm

T 609.00

Sadece sap / only handle

39 cm

1/3



BIER

T 607.10 Komple/Complete

(T 607.00 T 607.03 T 607.04

T 607.06)

T 607.00

Sadece sap / only handle

42 cm

Bleyd uzunluđu 270 mm

T 607.03 4 mm

T 607.04 6 mm

T 607.06 8 mm

1/3



V 606.00

V 505.04
3 ağızlı başlık
Three-jaw chuck
V 505.01 ve V 505.03 ile kullanılabilir.
Fitting to FF 058 and FF 059



V 505.03
Uzatma sapı
Extension handle



V 505.01
Delme başlığı
Hand Drill



V 608.00
Delme başlığı Ø 4.5 mm
Drilling chuck Ø 4.5 mm
V 606.00 Anahtarı ile
V 606.00 With key
14 cm



V 609.12
Delme başlığı Ø 6,35 mm
Drilling chuck Ø 6,35 mm
10 cm



V 605.00
V 606.00 Anahtarı ile
With key V 606.00

V 505.00 Komple/Complette
V 505.01 - V 505.03



V 557.01
Ø 1.6 ve 1.8 mm
pinler için
for 1.6 and 1.8 mm
diam.



V 554.01
Delme başlığı
Drilling chuck
Ø 0.8-2 mm
14 cm



V 609.04
Delme başlığı Ø 4,5 mm
Drilling chuck Ø 4,5 mm
V 606.00 Anahtarı ile / With Key

V 606.00



V 606.00

V 609.00
Delme başlığı Ø 6.35 mm
Drilling chuck Ø 6.35 mm
V 606.00 Anahtarı ile / With key
16 cm



STILLE
V 610.01
El matkabı / Hand drill only

V 610.00
12 ucu ile komple / Complete with 12 drills
V 610.02 - V 610.19

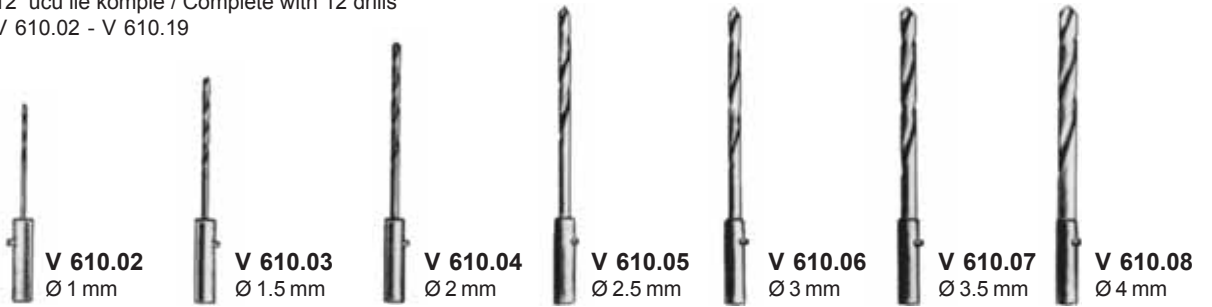
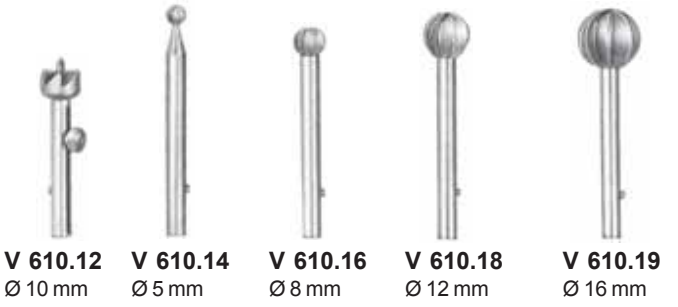

BUNNEL
V 615.00
El matkabı / Hand drill only
16 cm



RALK
V 617.01 Ø 6.35 mm
El matkabı / Hand drill only



V 608.00
Delme başlığı Ø 4.5 mm
Drilling chuck Ø 4.5 mm
V 606.00 Anahtarı ile
V 606.00 With key
14 cm

V 606.00
Key / Anahtar



Ayarlı sap
Adjustable handle

V 612.00
El matkabı / Hand drill only
28 cm



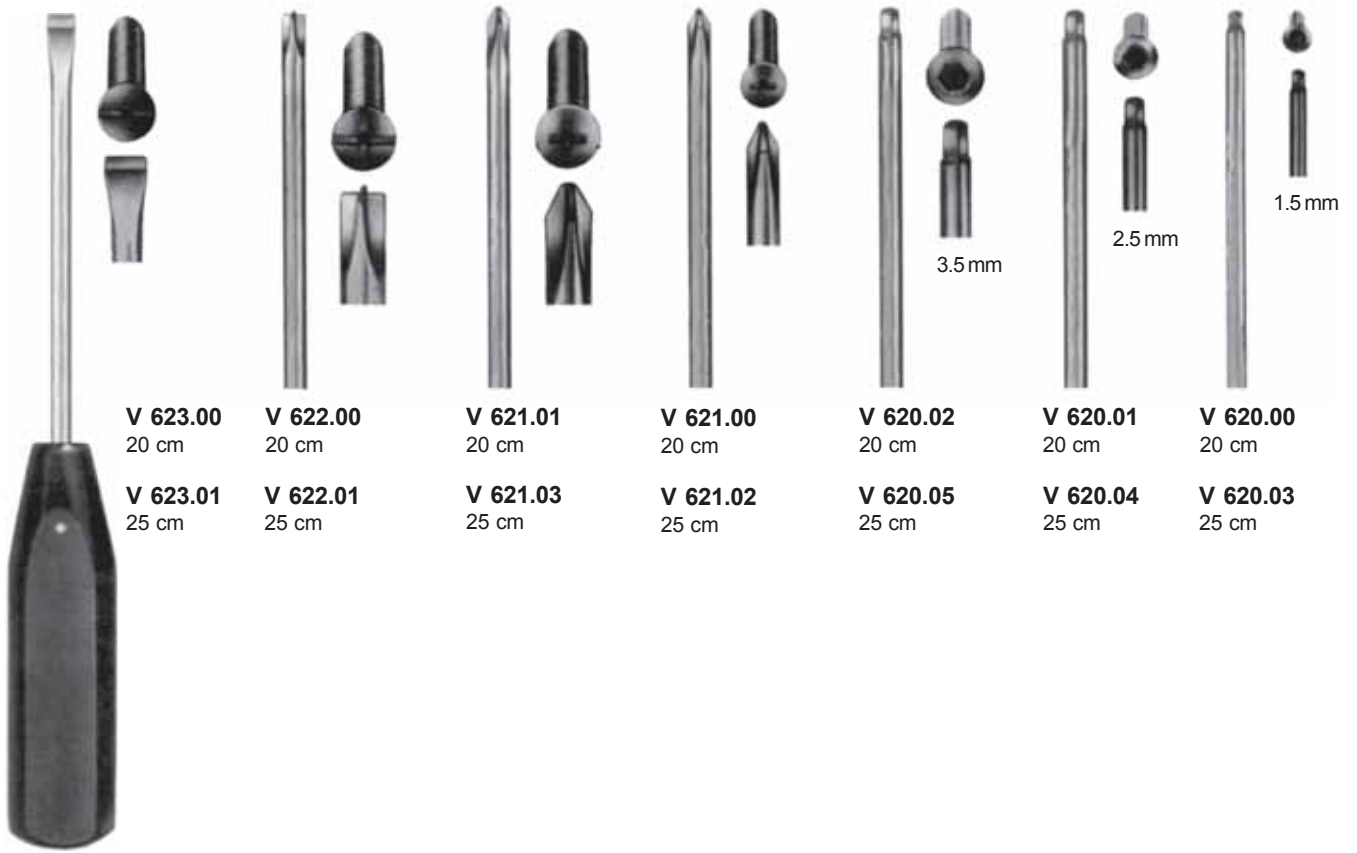

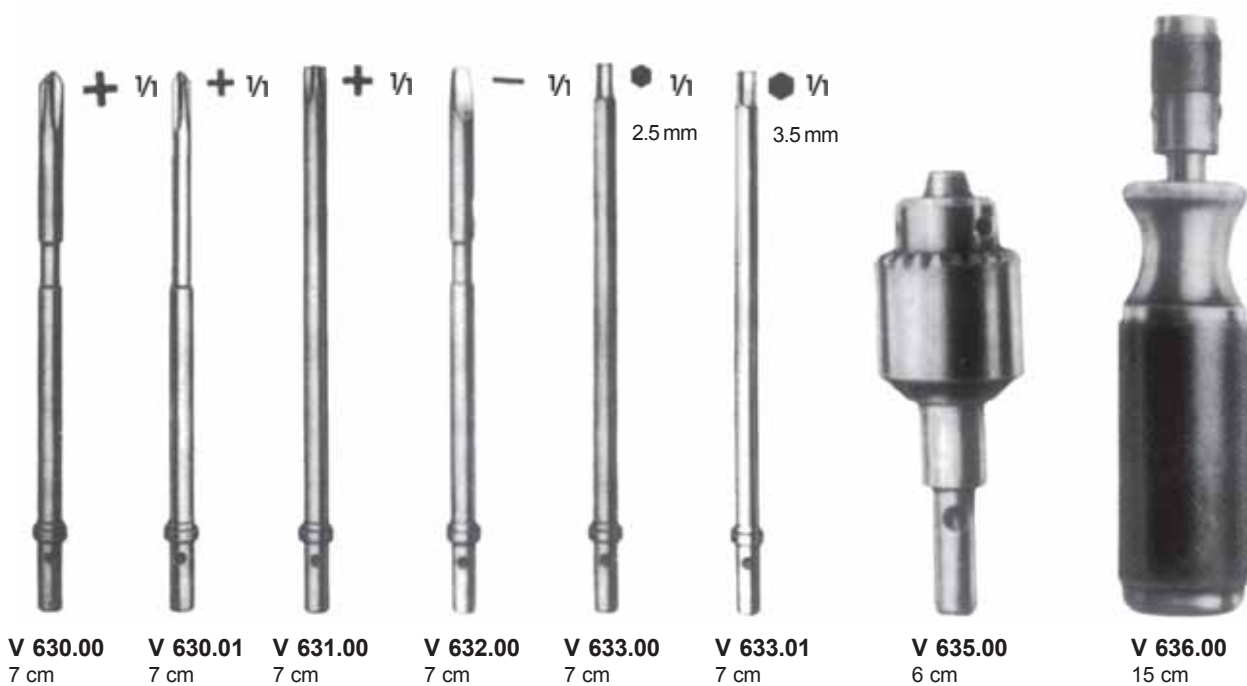

V 643.02
17.5 cm



V 643.00
17.5 cm

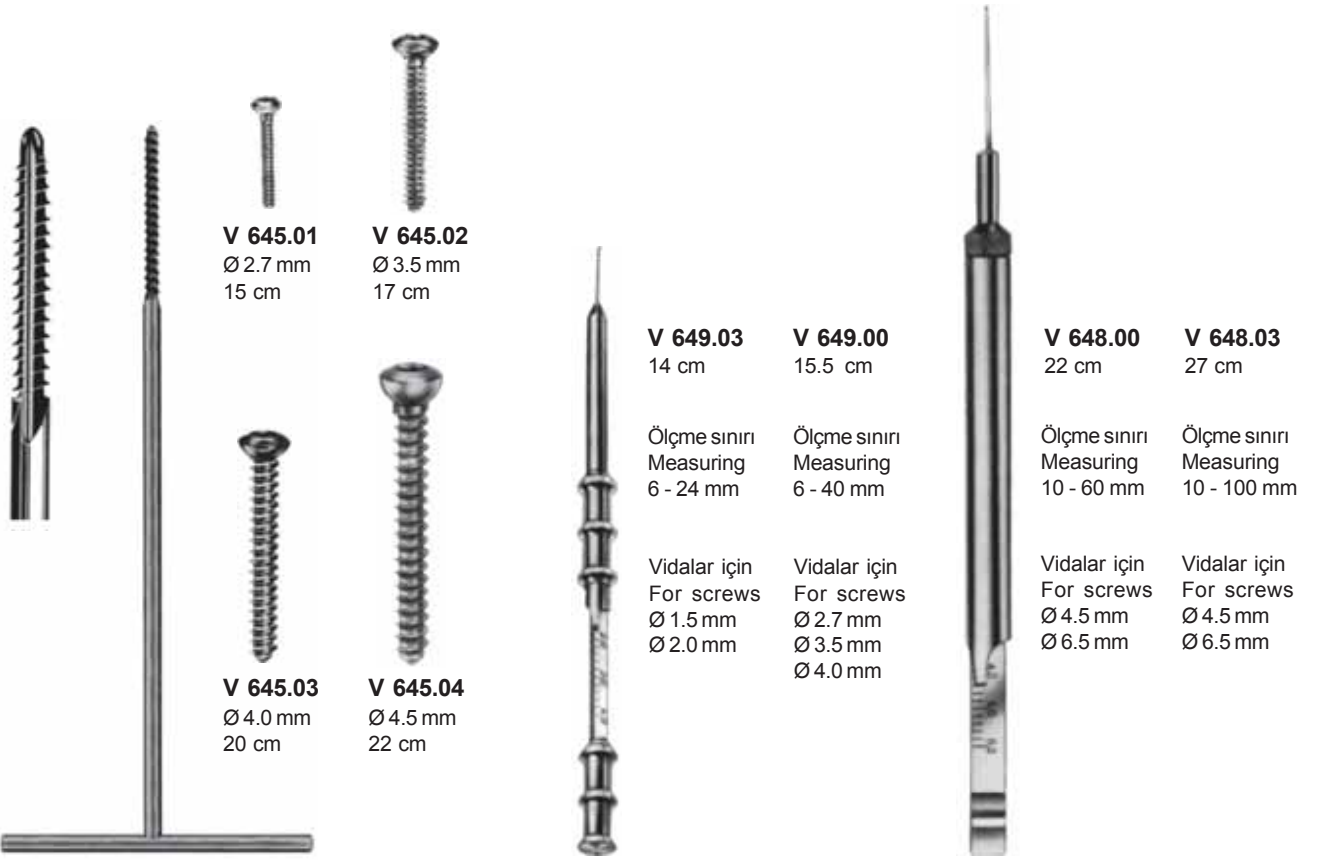

V 645.01 - V 645.04
Kemik tapları / Bone taps

V 645.01
Ø 2.7 mm
15 cm

V 645.02
Ø 3.5 mm
17 cm

V 645.03
Ø 4.0 mm
20 cm

V 645.04
Ø 4.5 mm
22 cm

V 649.03
14 cm

V 649.00
15.5 cm

Ölçme sınırı
Measuring
6 - 24 mm

Ölçme sınırı
Measuring
6 - 40 mm

Vidalar için
For screws
Ø 1.5 mm
Ø 2.0 mm

Vidalar için
For screws
Ø 2.7 mm
Ø 3.5 mm
Ø 4.0 mm

V 648.00
22 cm

V 648.03
27 cm

Ölçme sınırı
Measuring
10 - 60 mm

Ölçme sınırı
Measuring
10 - 100 mm

Vidalar için
For screws
Ø 4.5 mm
Ø 6.5 mm

Vidalar için
For screws
Ø 4.5 mm
Ø 6.5 mm

Otomatik vida Pensi
Shelf - holding screw forceps



T 610.00
Vida pensi
Screw holding forceps
9 cm



T 611.00
Vida pensi
Screw holding forceps
10 cm



T 615.00
Vida pensi
Screw holding forceps
20.5 cm



T 616.00
Plak tutucu
Plate holding forceps
20 cm



T 625.00
Bükme ve kıvrırma aparatı
Plate bending and contouring device



V 650.00
Sap / Handle



V 655.00
Ø 0,2 mm



V 655.01
Ø 0,2 mm



V 655.02
Ø 2.5 mm



V 655.03
Ø 2.5 mm



V 651.00
Sap / Handle



V 657.05
Ø 2.5 mm



V 657.06
Ø 2.5 mm



V 652.00
Sap / Handle



V 657.02
Ø 3.2 mm



V 657.03
Ø 3.2 mm



V 679.00
Dar Kemik Plakaları İçin Delik Klavuz Plakası
Drill Template for narrow, self Compressing bone Plates



V 679.03
Geniş Kemik Plakaları İçin Delik Klavuz Plakası
Drill Template for broad, self Compressing bone Plates



V 657.01
Ø 3.2 mm



V 657.00
Ø 3.2 mm



V 660.00
Mini delme kılavuzu
Mini drill guide
Ø 1.1 VE 1.5 mm matkap uçları için
For drills 1.1 and 1.5 mm diam.



V 661.00 Ø 2.0 mm
V 661.01 Ø 2.5 mm



V 663.00
Plakalar için matkap ucu kılavuzu
Ø 3.2 mm matkap uçları için



V 666.00
Delme kılavuzu / Drill guide
Ø 6.5 mm



V 668.00
Doku koruyucu / Tissue Protector
Ø 6.5 mm



V 662.05
Ø 1.5 mm



V 662.06
Ø 2.0 mm



V 662.00
Komple/Complete
V 662.01
Delme Kılavuzu Tutucusu
Holding Drill Guide Only
Ø 2.7 mm



40 mm

V 665.00
Delme kılavuzu / Drill guide
Ø 3.2 mm



60 mm

V 665.01
Delme kılavuzu / Drill guide
Ø 3.2 mm

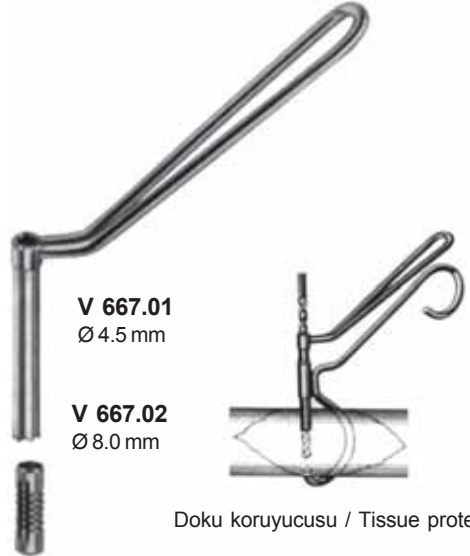

V 667.01
Ø 4.5 mm

V 667.02
Ø 8.0 mm

Doku koruyucusu / Tissue protector

V 667.00
Komple / Complete



V 669.00
Ø 3.5 mm



B 500.00
17 cm



NEFF
B 501.00
21.5 cm



NEFF
B 502.00
21.5 cm



WAGNER
B 504.00
21.5 cm



SALENIUS
B 506.00
22 cm



SALENIUS
B 507.00
22 cm

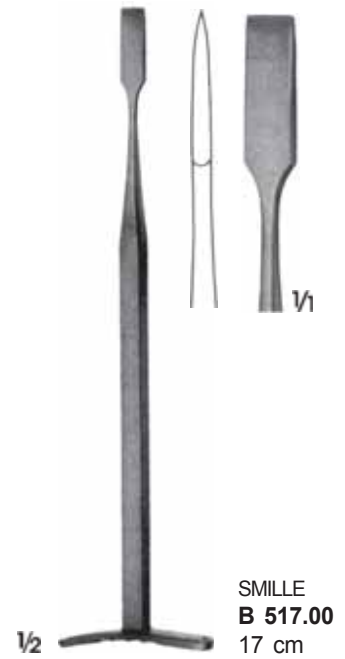
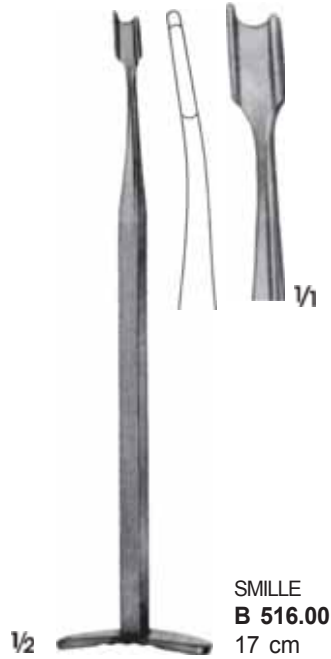
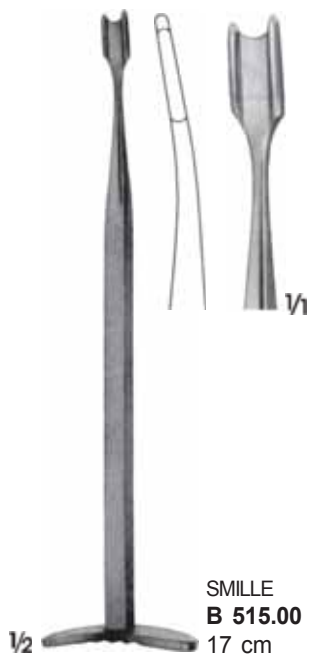

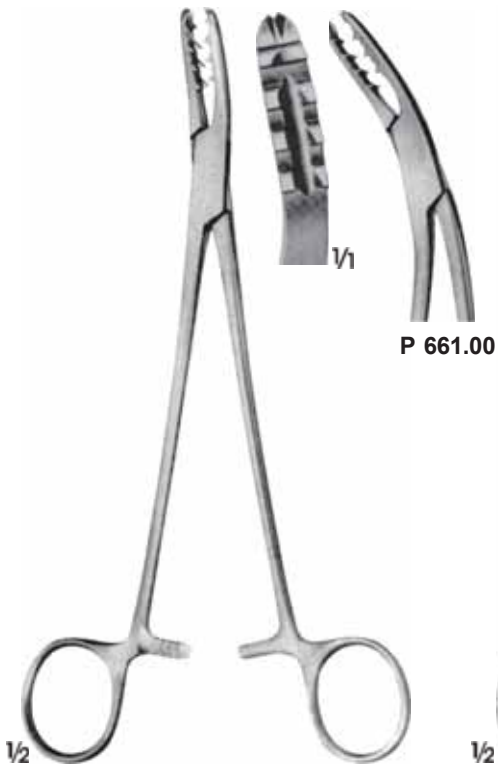

BIRCHER - GANSKE
P 660.00 - P 661.00
20 cm

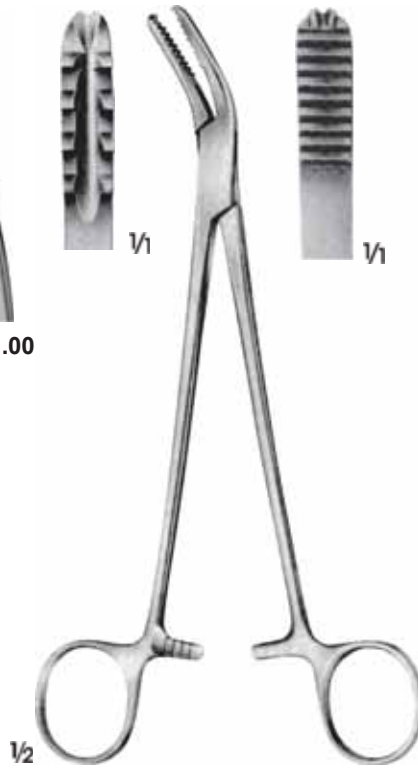

WELLER
P 662.00
20 cm



P 664.00
20.5 cm

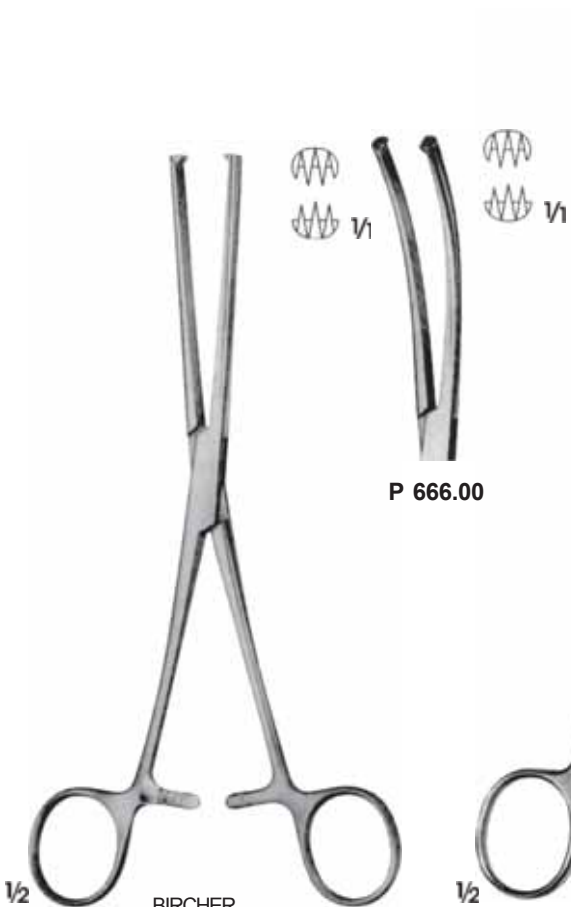

BIRCHER
P 665.00
20 cm



HERR
P 668.00
23 cm



JAGER
P 669.00
23.5 cm

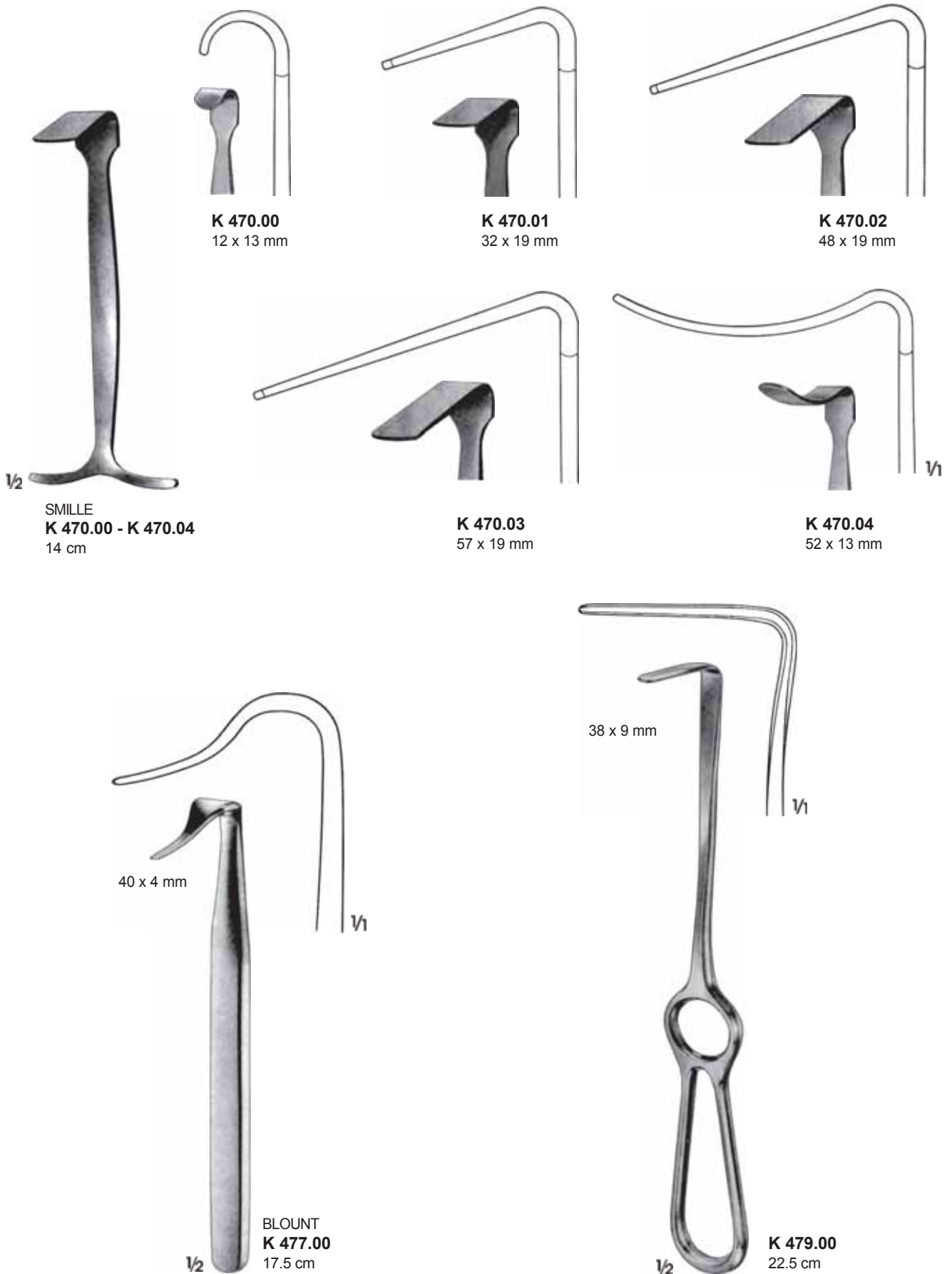

6 mm

**V 697.01**
Bağlantı vidası
Connection Screw**V 703.01**
Bağlantı şaftı
Connection shaft**V 698.01**
Dişli tel klavuzu
Guide wire with thread
1 paket 10 adet
1 package 10 pcs
23 cm**V 699.01**
Klavuz teli için ölçme aleti
Measuring gauge for guide wire
23 cm**T 635.01**
Klavuz/Tap**T 664.01**
Plaka/Plates**T 664.05**
Plaka yedeği
Spare Plate**T 628.01**
Kısa/Short**T 628.04**
Uzun/Long**V 686.03**
Standart silindirli plakalar için matkap ucu
Drill with countersink,
for plates with standart cylinder
38 mm**V 684.02**
T sapı
T-Handle



V 658.01



T 251.01
16 cm



T 252.01
Çıkarıcı/Extractor
21.5 cm



T 254.01
Çakıcı / Impactor
14 cm



RITCHEY
V 659.00
21 cm



V 561.01
Dental Saft
Dental Shaft



V 562.01
Yuvarlak Saft
Roun Shaft



V 564.01
Kare Saft
Square Shaft



Square Shaft



Synthes Shaft

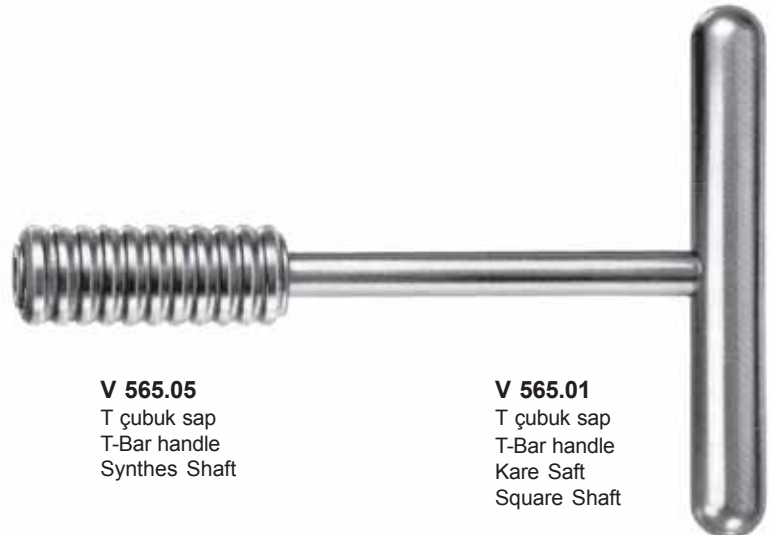

V 565.05
T çubuk sap
T-Bar handle
Synthes Shaft

V 565.01
T çubuk sap
T-Bar handle
Kare Saft
Square Shaft

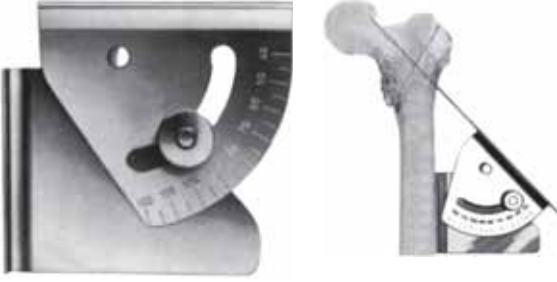

T 643.00
Ayarlı açı ölçer / Adjustable angle gauge

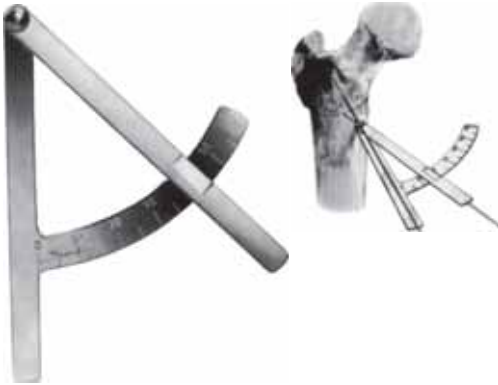

T 644.01
Ayarlı açı ölçer / Adjustable angle gauge

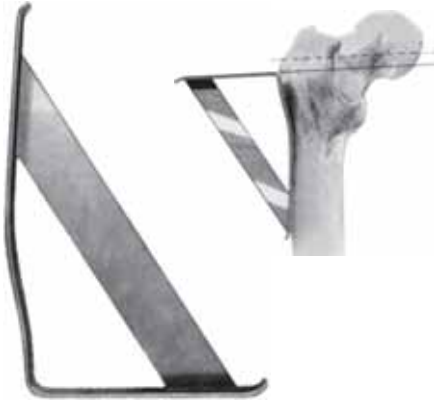

T 645.01
Açı kılavuzu/ Angle guide



T 641.00
10 cm

Açı kılavuzları / Angle guides



T 647.00



80° / 70° / 30°

T 648.00



90° / 50° / 40°

T 648.01



110° / 90° / 90° / 70°

T 648.02



100° / 60° / 20°

T 648.03



T 640.00
10 cm



V 712.00
10 cm



V 713.00
10 cm



V 711.00 Ø 3.5 mm
18 cm



V 712.10
Ø 4,5 mm
17 cm



V 710.00 Ø 2.5 mm
V 710.01 Ø 3.5 mm
14 cm



P 675.00
20 cm



M 711.03 9 mm
22 cm



V 704.00 3.5 mm
V 704.01 4.5 mm
V 704.02 6.5 mm

V 707.00 3.5 mm
V 707.01 4.5 mm
V 707.02 6.5 mm

V 706.00 3.5 mm
V 706.01 4.5 mm
V 706.02 6.5 mm

V 705.00 3.5 mm
V 705.01 4.5 mm
V 705.02 6.5 mm

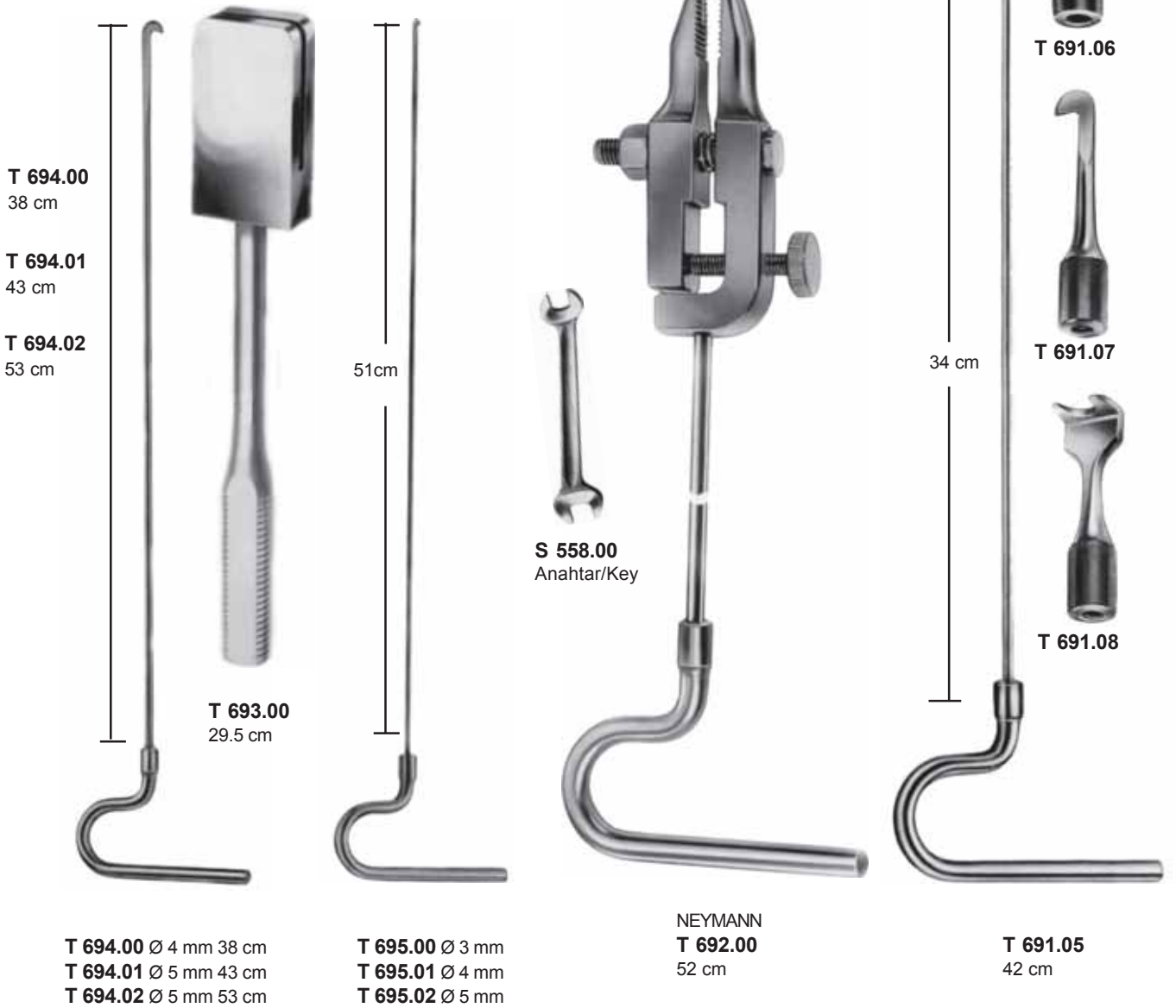



KUNTSCHER
V 721.00
Oyucu / Reamer
36 cm



T 685.00
Cilt koruyucu
Dura Protector
10 cm



KUNTSCHER
V 720.00 8 mm
V 720.01 10 mm
Oyucu / Reamer
26 cm

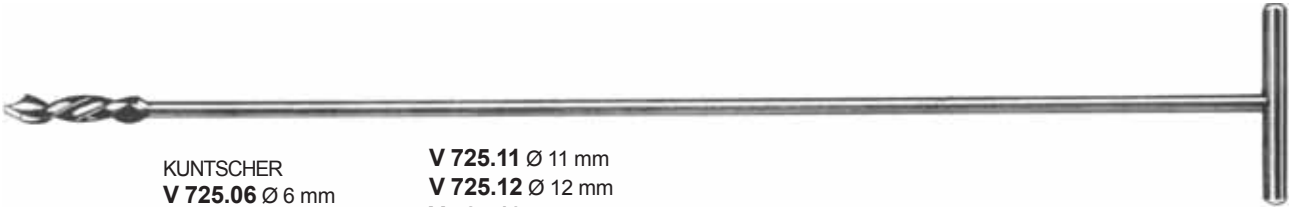

KUNTSCHER
V 725.06 Ø 6 mm
V 725.07 Ø 7 mm
V 725.08 Ø 8 mm
V 725.09 Ø 9 mm
V 725.10 Ø 10 mm

V 725.11 Ø 11 mm
V 725.12 Ø 12 mm
V 725.13 Ø 13 mm
V 725.14 Ø 14 mm
V 725.15 Ø 15 mm
V 725.16 Ø 16 mm

Sabit oyucu
Fixed reamer
50 cm

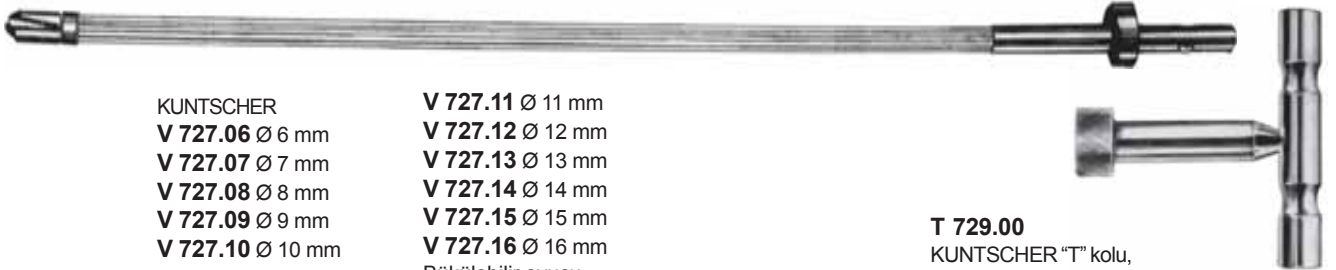

KUNTSCHER
V 727.06 Ø 6 mm
V 727.07 Ø 7 mm
V 727.08 Ø 8 mm
V 727.09 Ø 9 mm
V 727.10 Ø 10 mm

V 727.11 Ø 11 mm
V 727.12 Ø 12 mm
V 727.13 Ø 13 mm
V 727.14 Ø 14 mm
V 727.15 Ø 15 mm
V 727.16 Ø 16 mm

Bükülebilir oyucu
Malleable reamer
48 cm

T 729.00
KUNTSCHER "T" kolu,
bükülebilir oyucular için
"T" Wrench, for malleable reamers



V 728.02 Ø 2.5 mm
V 728.03 Ø 3.0 mm
V 728.04 Ø 3.5 mm
V 728.05 Ø 4.0 mm

V 728.06 Ø 5.0 mm
V 728.07 Ø 6.0 mm
V 728.08 Ø 8.0 mm
V 728.09 Ø 10.0 mm
Kılavuz teli / Wire guide
60 cm



T 689.00 Ø 21 mm
T 689.01 Ø 17 mm
T 689.02 Ø 12.7 mm
Çakıcı / Impactor
20 cm



T 688.00 13 mm
T 688.01 10 mm
T 688.03 16 mm
T 688.05 20 mm
Çakıcı / Impactor
19 cm

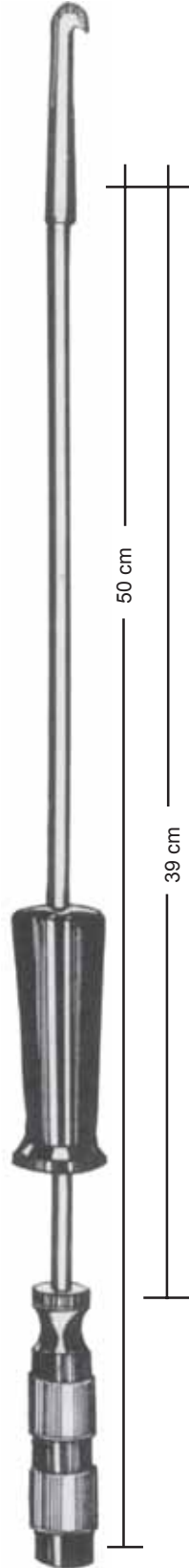

KUNTSCHER
T 690.00
Çıkartıcı / Extractor
50 cm



T 691.00
50 cm



T 691.01



T 691.02



T 691.03



T 691.04

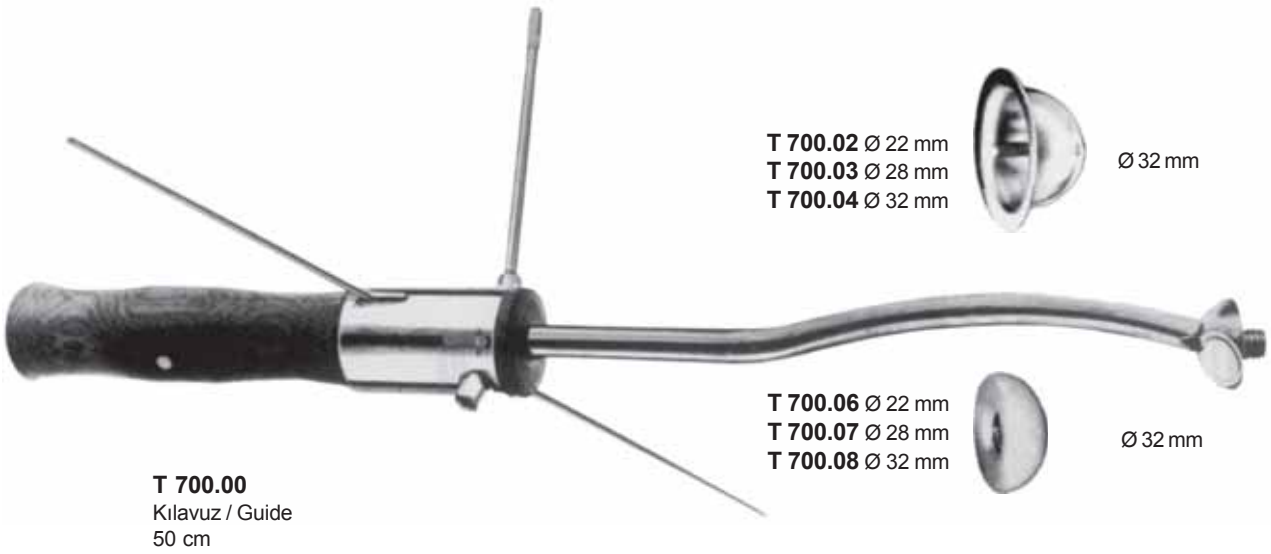

T 701.00
İtici / Pusher
25 cm



T 702.00
İtici / Pusher
14 cm



T 703.00
İtici / Pusher
14 cm



T 705.00
İtici / Pusher
20 cm



AUSTIN
T 710.00
21 cm

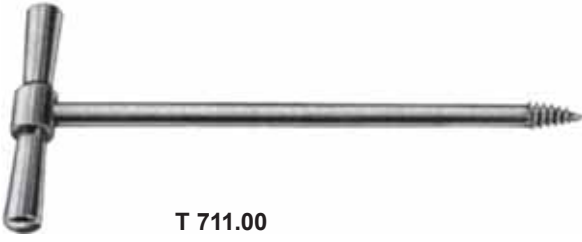

T 711.00
Çıkartıcı / Extractor
25 cm



T 712.00
Çıkartıcı / Extractor
27 cm



T 714.00 MORE Protez Çıkartıcı
MORE Protheses extractor



L 895.00
Kalça ekartörü
Hip retractor



T 795.00
Zincirli ağırlık
Weight with chain



T 720.00
Çement İtici
Cement Pusher
30 cm



T 721.00
Çement İtici
Cement Pusher
30 cm



M 745.00 - M 747.02
Osteotom ve guj
Chisel and gouge
35 cm



M 745.00
5 mm



M 746.00
5 mm



M 747.00
5 mm



M 745.01
7 mm



M 746.01
7 mm



M 747.01
7 mm



M 745.02
10 mm



M 746.02
10 mm



M 747.02
7 mm



Osteotom/Çizil
Osteotom/Chisel



Guj / Gouge



Guj / Gouge



R 780.00
40 cm

V 735.00
Ø 6 mm
40 cm

V 736.00
Ø 8 mm
40 cm

V 737.00
Ø 10 mm
40 cm

T 725.00
Çekiç / Mallet
22 cm

T 726.00 Ø 7 mm
T 726.01 Ø 9 mm
T 726.02 Ø 11 mm
Çement çıkartıcı
Cement extractor
60 cm



BLOUNTY
T 671.01
Çakıcı / Extractors
19 cm



T 673.00
Çakıcı / Extractors
20 cm



BLOUNT
T 672.00
Çakıcı / Extractors
18.5 cm



BLOUNT
T 670.00
İtici / Inserter
19 cm





T 745.00
15 cm



T 746.00
15 cm



T 747.00
20 cm



T 749.00
20 cm



D 570.00
14 cm



D 571.00
14 cm



D 572.00
15 cm



D 575.00
16 cm



D 576.00
15 cm



P 617.00
14 cm

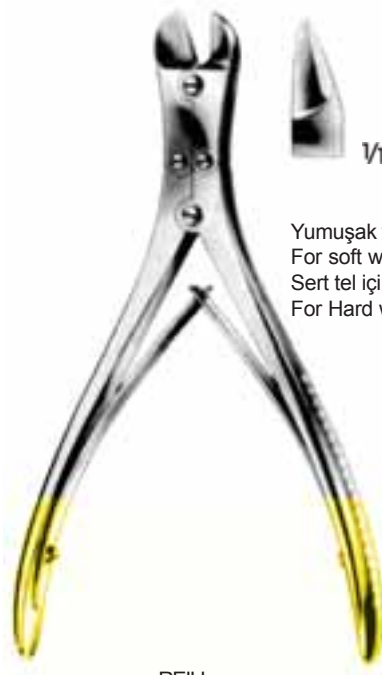

REILL
P 640.00
17.5 cm

Yumuşak tel için Ø 2.0 mm
For soft wire Ø 2.0 mm
Sert tel için Ø 1.6 mm
For Hard wire Ø 1.6 mm



P 683.00
15 cm



V 750.00
1.5 mm



V 752.00
20 cm

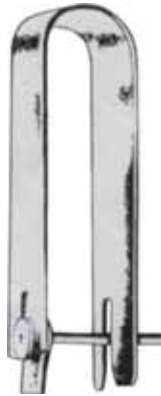

V 754.04
V 754.05 - V 754.06
ile kullanılır.
To be use with
V 754.05 and V 754.06



V 754.00
Kılavuz / Guide
23 cm



V 754.05
Ø 2.5 mm



V 754.06
Pin

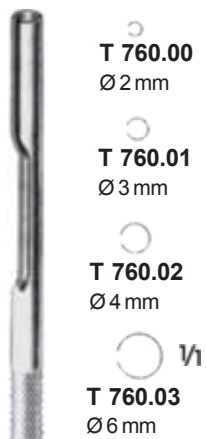
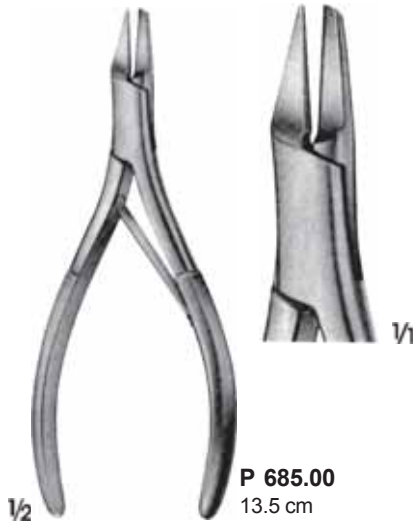

BUNNELL
T 760.00 - T 760.03
15 cm



T 761.00
Ø4 mm

T 761.01
Ø4.5 mm

T 761.02
Ø5.5 mm

T 761.00 - T 761.02
23 cm



FISCHER
T 765.00
31 cm



T 766.00
Ø3 mm

T 766.01
Ø6 mm

BRAND
T 766.00 30 cm
T 766.01 50 cm



P 687.00
14.5 cm



V 760.05 Sap/Handle
14.5 cm

V 760.10 Komple/Complete
(V 760.00, V 760.01, V 760.02, V 760.05)



JOSEPH
V 765.00
17 cm



LINDEMANN
V 766.00
20 cm



P 670.00
15 cm

P 670.01
Yedek bleyd
Spare blade



T 750.00 Çocuklar için / Child size
T 750.01 Büyükler için / Adult size



T 752.00

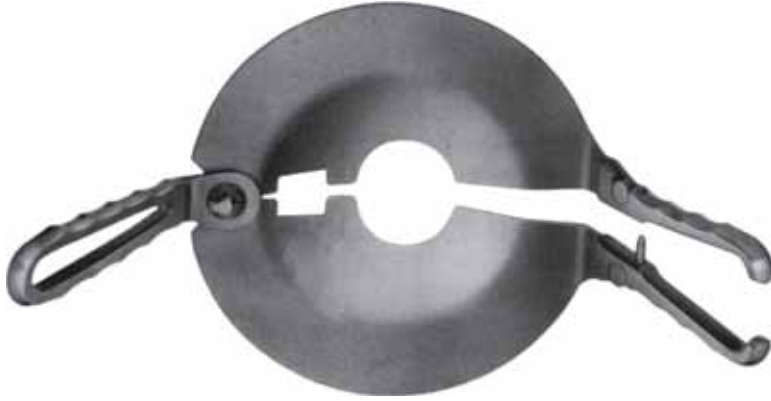

PERCY
T 890.00
Sökülebilir Saplı
Removable handles



PERCY
T 891.00
Ters çevrilebilir saplı
Reversible handles



B 550.00
20 cm



B 550.01



B 550.02



B 550.03



H 821.01



H 821.00



K 550.06



N 094.00



B 550.08



B 550.09



B 550.10



B 550.11



B 550.12



B 550.13



B 550.14



B 550.15



B 550.16



B 550.17



B 550.18



M 095.00



M 095.01



M 096.00



M 096.01



N 096.00



N 097.00



M 097.00



M 097.01



N 302.00



N 302.01



N 302.03



N 302.04



B 552.01



B 552.02



B 552.03



H 820.02



H 820.01



K 551.00



N 093.00



B 552.08



B 552.09



B 552.10



B 552.11



B 552.12



B 552.13



B 552.14



B 552.15



B 552.16



B 552.17



B 552.18



M 090.00



M 090.01



M 091.00



M 091.01



N 098.00



N 099.00



M 092.00



M 092.01



R 500.01 - R 509.04
22 cm

huk makas
hook scissors



- R 500.01 2.7mm düz/straight
- R 500.02 2.7 mm 30° sağ/right
- R 500.03 2.7 mm 45° sağ/right
- R 501.01 2.7 mm 30° sol/left
- R 501.02 2.7 mm 45° sol/left

huk pañç
hook punch



- R 502.01
- R 502.02
- R 502.03
- R 503.01
- R 503.02

huk pañç
hook punch



- R 504.01
- R 504.02
- R 504.03
- R 505.01
- R 505.02

pañç
punch



- R 506.01
- R 506.02
- R 506.03
- R 507.01
- R 507.02

biyopsi pañç
biopsy punch



- R 508.01
- R 508.02
- R 508.03
- R 509.01
- R 509.02

- R 500.05 3.5 mm düz/straight
- R 500.06 3.5 mm 30° sağ/right
- R 500.07 3.5 mm 45° sağ/right
- R 501.03 3.5 mm 30° sol/left
- R 501.04 3.5 mm 45° sol/left

- R 502.05
- R 502.06
- R 502.07
- R 503.03
- R 503.04

- R 504.04
- R 504.05
- R 504.06
- R 505.03
- R 505.04

- R 506.04
- R 506.05
- R 506.06
- R 507.03
- R 507.04

- R 508.04
- R 508.05
- R 508.06
- R 509.03
- R 509.04

huk makas 45°
hook scissors 45°



- R 510.01 3.5 mm sağ
- R 511.01 3.5 mm sol

pañç 45°
punch 45°



- R 512.01 3.5 mm sağ
- R 513.01 3.5 mm sol

pañç 90°
punch 90°



- R 514.01 3 mm sağ
- R 515.01 3 mm sol

pañç 0°
punch 0°



- R 516.01 3 mm



R 519.01 - R 523.02
22 cm

R 518.01 - R 522.02
22 cm



2.7 mm kilitli
3.5 mm with lock

R 518.01
R 518.02

R 520.01
R 520.02

R 522.01
R 522.02

2.7 mm kilitsiz
3.5 mm nonlock

R 519.01
R 519.02

R 521.01
R 521.02

R 523.01
R 523.02



R 525.01
20 cm

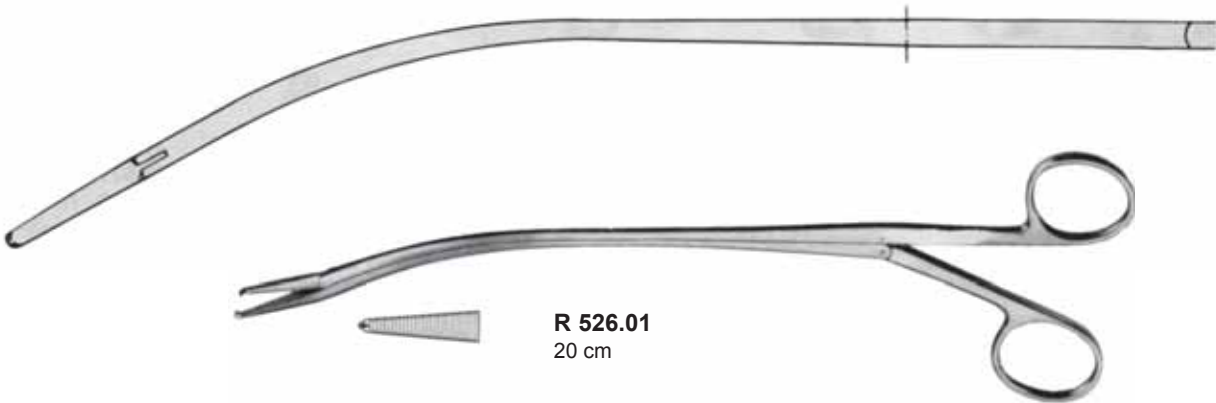

R 526.01
20 cm

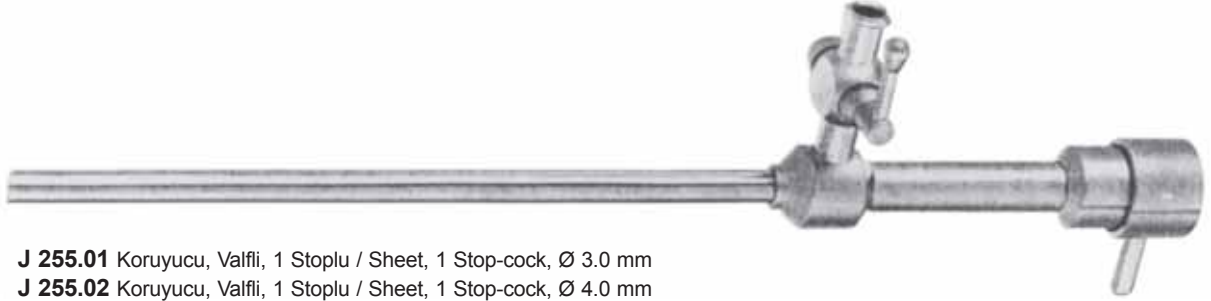

J 255.01 Koruyucu, Valfli, 1 Stoplu / Sheet, 1 Stop-cock, Ø 3.0 mm

J 255.02 Koruyucu, Valfli, 1 Stoplu / Sheet, 1 Stop-cock, Ø 4.0 mm



J 256.01 Koruyucu, 1 Stoplu, Dönerli / Sheet, 1 Stop-cock, Rotating, Ø 3.0 mm

J 256.02 Koruyucu, 1 Stoplu, Dönerli / Sheet, 1 Stop-cock, Rotating, Ø 4.0 mm

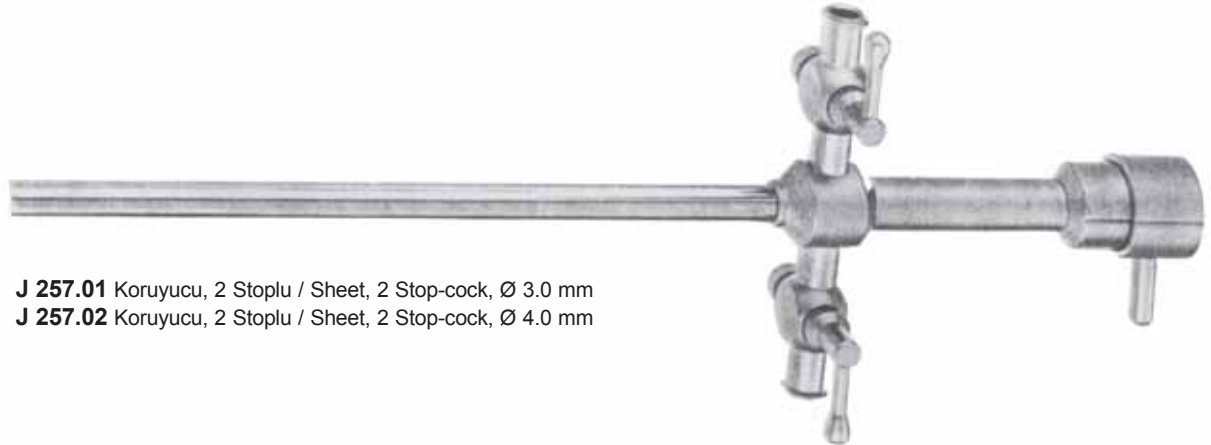

J 257.01 Koruyucu, 2 Stoplu / Sheet, 2 Stop-cock, Ø 3.0 mm

J 257.02 Koruyucu, 2 Stoplu / Sheet, 2 Stop-cock, Ø 4.0 mm



J 258.01 Koruyucu, 2 Stoplu, Dönerli / Sheet, 2 Stop-cock, Rotating, Ø 3.0 mm

J 258.02 Koruyucu, 2 Stoplu, Dönerli / Sheet, 2 Stop-cock, Rotating, Ø 4.0 mm



J 240.01 Kılıf/Obturator, Ø 3.0 mm
J 240.02 Kılıf/Obturator, Ø 4.0 mm



J 241.01 Trokar/Trocar, Ø 3.0 mm
J 241.02 Trokar/Trocar, Ø 4.0 mm



Boy	Ø	0 C°		30 C°		45 C°		70 C°	
		Standart	Otoklav Edilebilir Autoclavable	Standart	Otoklav Edilebilir Autoclavable	Standart	Otoklav Edilebilir Autoclavable	Standart	Otoklav Edilebilir Autoclavable
17.5 cm	2.7 mm	A 890.00	A 891.00	A 890.30	A 891.30	A 890.45	A 891.45	A 890.70	A 891.70
17.5 cm	4.0 mm	A 900.00	A 901.00	A 900.30	A 901.30	A 900.45	A 901.45	A 900.70	A 901.70



Z 120.00
11.5 cm

İzolesiz
Non-insulated



Z 121.00
12 cm

İzolesiz
Non-insulated



Z 100.00 0.3 mm
14 cm

İzolesiz
Non-insulated



Z 150.00 0.6 mm
Z 150.01 0.9 mm
16 cm

İzoleli
Insulated

Z 150.03 0.9 mm
20 cm



Z 151.01 0.9 mm
16 cm

İzoleli
Insulated

Z 151.03 0.9 mm
20 cm



Z 180.00 0.7 mm
16 cm

İzolesiz
Non-insulated

Z 180.01 1.0 mm
18.5 cm

Z 180.02 1.0 mm
20 cm

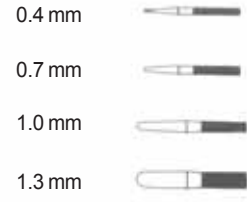

İzolesiz
Non-insulated

Z 170.01 0.9 mm
16 cm

Z 170.04 0.9 mm
18.5 cm

Z 170.07 0.9 mm
20 cm



İzoleli
Insulated

Z 171.01 0.9 mm
16 cm
İzolesiz/Non-insulated

Z 172.01 0.9 mm
18.5 cm
İzoleli/Insulated



İzoleli
Insulated

Z 160.08 0.4 mm
Z 160.09 0.7 mm
Z 160.10 1.0 mm
Z 160.11 1.3 mm
17.5 cm

Z 160.12 0.4 mm
Z 160.13 0.7 mm
Z 160.14 1.0 mm
Z 160.15 1.3 mm
19.5 cm

Z 160.16 0.4 mm
Z 160.17 0.7 mm
Z 160.18 1.0 mm
Z 160.19 1.3 mm
21.5 cm

Z 160.20 0.4 mm
Z 160.21 0.7 mm
Z 160.22 1.0 mm
Z 160.23 1.3 mm
23.5 cm



Z 188.00 1.0 mm
21.5 cm
İzolesiz/Non-insulated



Z 190.00 1.0 mm
21.5 cm
İzoleli/Insulated



Z 001.00
Oval kesme elektrodu
Cutting electrode
Boy/Length 30 mm
En/Wide 3.5 mm



Z 002.00
Açılı kesme elektrodu
Angled cutting electrode
Boy/Length 14 mm
En/Wide 1.8 mm



Z 003.00
Kesme elektrodu, hassas
Cutting electrode, delicate
25 mm



Z 004.00
Bıçak elektrod
Knife electrode
25 mm



Z 005.00
Bıçak elektrod
Knife electrode
18 mm



Z 010.00
Plaka elektrod
Plate electrode



Z 006.00
Halkalı elektrodu
Loop electrode
Ø 10 mm
Tel Ø 3 mm/Wire Ø 3 mm



Z 009.00
Halkalı elektrodu
Loop electrode
Ø 15 mm



Z 012.00
Açılı Halkalı elektrodu
Angled Loop electrode
Ø 8 mm



Z 015.00 Ø 2.5 mm
Z 015.01 Ø 4 mm
Z 015.02 Ø 6 mm
Küresel uçlu
elektrodu
Ball point electrode



Z 016.00 Ø 0.3 mm
Z 016.01 Ø 0.5 mm
Z 016.02 Ø 0.7 mm
İğne elektrodu
Needle electrode
25 cm



Z 095.00 Komple/Complete
Cerrahi elektrodlar - Surgical electrodes
Ø 4 mm

12 elektrodruk ray
Rack for 12 surgical electrodes



Z 060.00
Elektrod tutucusu
Electrode holder

Z 065.00
Bipolar kordon
Bipolar cord
2 mt.



Z 096.00
Kapalı elektrot konteyneri
Container with lid for electrodes

Z 097.00 Komple / Complete
Z 095.00 - Z 096.00









STERILE CONTAINER SYSTEM









basic model
Types and Dimensions
1/1 size containers

Bottom Non Perforated







-  Y 110.10
-  Y 120.10
-  Y 130.10
-  Y 140.10
-  Y 150.10
-  Y 160.10







weight 2634 gr

-  Y 110.13
-  Y 120.13
-  Y 130.13
-  Y 140.13
-  Y 150.13
-  Y 160.13







weight 3129.5 gr

-  Y 110.15
-  Y 120.15
-  Y 130.15
-  Y 140.15
-  Y 150.15
-  Y 160.15

weight 3219 gr

-  Y 110.20
-  Y 120.20
-  Y 130.20
-  Y 140.20
-  Y 150.20
-  Y 160.20

weight 3427.5 gr

-  Y 110.26
-  Y 120.26
-  Y 130.26
-  Y 140.26
-  Y 150.26
-  Y 160.26

weight 3919 gr

Bottom Perforated



-  Y 111.10
-  Y 121.10
-  Y 131.10
-  Y 141.10
-  Y 151.10
-  Y 161.10

weight 3156 gr

-  Y 111.13
-  Y 121.13
-  Y 131.13
-  Y 141.13
-  Y 151.13
-  Y 161.13







weight 3244 gr

-  Y 111.15
-  Y 121.15
-  Y 131.15
-  Y 141.15
-  Y 151.15
-  Y 161.15

weight 3382 gr

-  Y 111.20
-  Y 121.20
-  Y 131.20
-  Y 141.20
-  Y 151.20
-  Y 161.20

weight 3738.5 gr

-  Y 111.26
-  Y 121.26
-  Y 131.26
-  Y 141.26
-  Y 151.26
-  Y 161.26

weight 4272.5 gr



outside dim.	580 x 280 x 100 mm
inside dim.	550 x 265 x 84 mm



outside dim.	580 x 280 x 135 mm
inside dim.	550 x 265 x 115 mm



outside dim.	580 x 280 x 150 mm
inside dim.	550 x 265 x 130 mm



outside dim.	580 x 280 x 200 mm
inside dim.	550 x 265 x 180 mm



outside dim.	580 x 280 x 260 mm
inside dim.	550 x 265 x 240 mm







safe model

Types and Dimensions

1/1 size containers

Bottom Non Perforated









-  Y 112.10
-  Y 122.10
-  Y 132.10
-  Y 142.10
-  Y 152.10
-  Y 162.10





weight | 3486 gr

-  Y 112.13
-  Y 122.13
-  Y 132.13
-  Y 142.13
-  Y 152.13
-  Y 162.13

weight | 3981.5 gr

-  Y 112.15
-  Y 122.15
-  Y 132.15
-  Y 142.15
-  Y 152.15
-  Y 162.15

weight | 4070.5 gr

-  Y 112.20
-  Y 122.20
-  Y 132.20
-  Y 142.20
-  Y 152.20
-  Y 162.20

weight | 4280 gr

-  Y 112.26
-  Y 122.26
-  Y 132.26
-  Y 142.26
-  Y 152.26
-  Y 162.26

weight | 4770.5 gr



outside dim. | 580 x 280 x 100 mm
inside dim. | 550 x 265 x 84 mm



outside dim. | 580 x 280 x 135 mm
inside dim. | 550 x 265 x 115 mm



outside dim. | 580 x 280 x 150 mm
inside dim. | 550 x 265 x 130 mm



outside dim. | 580 x 280 x 200 mm
inside dim. | 550 x 265 x 180 mm



outside dim. | 580 x 280 x 260 mm
inside dim. | 550 x 265 x 240 mm

Bottom Perforated









-  Y 113.10
-  Y 123.10
-  Y 133.10
-  Y 143.10
-  Y 153.10
-  Y 163.10







weight | 4007.5 gr

-  Y 113.13
-  Y 123.13
-  Y 133.13
-  Y 143.13
-  Y 153.13
-  Y 163.13







weight | 4095.5 gr

-  Y 113.15
-  Y 123.15
-  Y 133.15
-  Y 143.15
-  Y 153.15
-  Y 163.15

weight | 4233 gr

-  Y 113.20
-  Y 123.20
-  Y 133.20
-  Y 143.20
-  Y 153.20
-  Y 163.20

weight | 4589 gr

-  Y 113.26
-  Y 123.26
-  Y 133.26
-  Y 143.26
-  Y 153.26
-  Y 163.26

weight | 5140 gr

bottoms and lids

Bottom Non Perforated



	outside dim.	inside dim.	weight
Y 105.10	580 x 280 x 100 mm	550 x 262 x 84 mm	1523 gr
Y 105.13	580 x 280 x 135 mm	550 x 262 x 117 mm	2019 gr
Y 105.15	580 x 280 x 150 mm	550 x 262 x 132 mm	2108 gr
Y 105.20	580 x 280 x 200 mm	550 x 262 x 182 mm	2317 gr
Y 105.26	580 x 280 x 260 mm	550 x 262 x 244 mm	2808 gr

Bottom Perforated



	outside dim.	inside dim.	weight
Y 106.10	580 x 280 x 100 mm	550 x 262 x 84 mm	2044 gr
Y 106.13	580 x 280 x 135 mm	550 x 262 x 117 mm	2132 gr
Y 106.15	580 x 280 x 150 mm	550 x 262 x 132 mm	2270 gr
Y 106.20	580 x 280 x 200 mm	550 x 262 x 182 mm	2627 gr
Y 106.26	580 x 280 x 260 mm	550 x 262 x 244 mm	2851 gr

Types and Dimensions

580 x 280 mm

Lid Perforated

Y 100.01

Y 100.02

Y 100.03

Y 100.04

Y 100.05

Y 100.06

weight 1111 gr



Safety Lid

Y 103.01

Y 103.02

Y 103.03

Y 103.04

Y 103.05

Y 103.06

weight 851.5 gr



Wire Baskets

	outside dim.	weight
Y 190.03	485 x 255 x 30 mm	1108 gr
Y 190.05	485 x 255 x 50 mm	1112 gr
Y 190.07	485 x 255 x 70 mm	1176 gr
Y 190.10	485 x 255 x 100 mm	1289 gr



	outside dim.	weight
Y 191.03	540 x 255 x 30 mm	1149 gr
Y 191.05	540 x 255 x 50 mm	1189 gr
Y 191.07	540 x 255 x 70 mm	1259 gr
Y 191.10	540 x 255 x 100 mm	1354 gr

accessories
Wire Base

Y 193.00	545 x 255 x 30 mm	729 gr
----------	-------------------	--------

Drape Retainer

Y 195.00	545 x 255 mm
----------	--------------

Drape

Y 095.07	130 x 60 cm
Y 095.08	140 x 100 cm
Y 095.09	185 x 45 cm
Y 095.10	185 x 60 cm

basic model
3/4 size containers
Types and Dimensions

Bottom Non Perforated



-  Y 210.10
-  Y 220.10
-  Y 230.10
-  Y 240.10
-  Y 250.10
-  Y 260.10

weight | 2268,5 gr

-  Y 210.13
-  Y 220.13
-  Y 230.13
-  Y 240.13
-  Y 250.13
-  Y 260.13

weight | 2549,5 gr

-  Y 210.15
-  Y 220.15
-  Y 230.15
-  Y 240.15
-  Y 250.15
-  Y 260.15

weight | 2620,5 gr

Bottom Perforated



-  Y 211.10
-  Y 221.10
-  Y 231.10
-  Y 241.10
-  Y 251.10
-  Y 261.10

weight | 2503 gr

-  Y 211.13
-  Y 221.13
-  Y 231.13
-  Y 241.13
-  Y 251.13
-  Y 261.13

weight | 2715 gr

-  Y 211.15
-  Y 221.15
-  Y 231.15
-  Y 241.15
-  Y 251.15
-  Y 261.15

weight | 2718 gr



outside dim.	465 x 280 x 100 mm
inside dim.	425 x 260 x 84 mm



outside dim.	465 x 280 x 135 mm
inside dim.	425 x 260 x 115 mm



outside dim.	465 x 280 x 150 mm
inside dim.	425 x 260 x 130 mm

safe model

3/4 size containers

Types and Dimensions

Bottom Non Perforated



-  Y 212.10
-  Y 222.10
-  Y 232.10
-  Y 242.10
-  Y 252.10
-  Y 262.10

weight 2990 gr

-  Y 212.13
-  Y 222.13
-  Y 232.13
-  Y 242.13
-  Y 252.13
-  Y 262.13

weight 3260 gr

-  Y 212.15
-  Y 222.15
-  Y 232.15
-  Y 242.15
-  Y 252.15
-  Y 262.15

weight 3975 gr

Bottom Perforated



-  Y 213.10
-  Y 223.10
-  Y 233.10
-  Y 243.10
-  Y 253.10
-  Y 263.10

weight 3213,5 gr

-  Y 213.13
-  Y 223.13
-  Y 233.13
-  Y 243.13
-  Y 253.13
-  Y 263.13

weight 3425 gr

-  Y 213.15
-  Y 223.15
-  Y 233.15
-  Y 243.15
-  Y 253.15
-  Y 263.15

weight 3561 gr



outside dim. 465 x 280 x 100 mm
inside dim. 425 x 260 x 84 mm



outside dim. 465 x 280 x 135 mm
inside dim. 425 x 260 x 115 mm



outside dim. 465 x 280 x 150 mm
inside dim. 425 x 260 x 130 mm

bottoms and lids

Bottom Non Perforated



	outside dim.	inside dim.	weight
Y 205.10	465 x 280 x 100 mm	425 x 262 x 85 mm	1396 gr
Y 205.13	465 x 280 x 135 mm	425 x 262 x 121 mm	1675 gr
Y 205.15	465 x 280 x 150 mm	425 x 262 x 135 mm	1792 gr

Bottom Perforated



	outside dim.	inside dim.	weight
Y 206.10	465 x 280 x 100 mm	425 x 262 x 85 mm	1629 gr
Y 206.13	465 x 280 x 135 mm	425 x 262 x 121 mm	1842 gr
Y 206.15	465 x 280 x 150 mm	425 x 262 x 135 mm	1978 gr

Types and Dimensions

Lid Perforated



Safety Lid

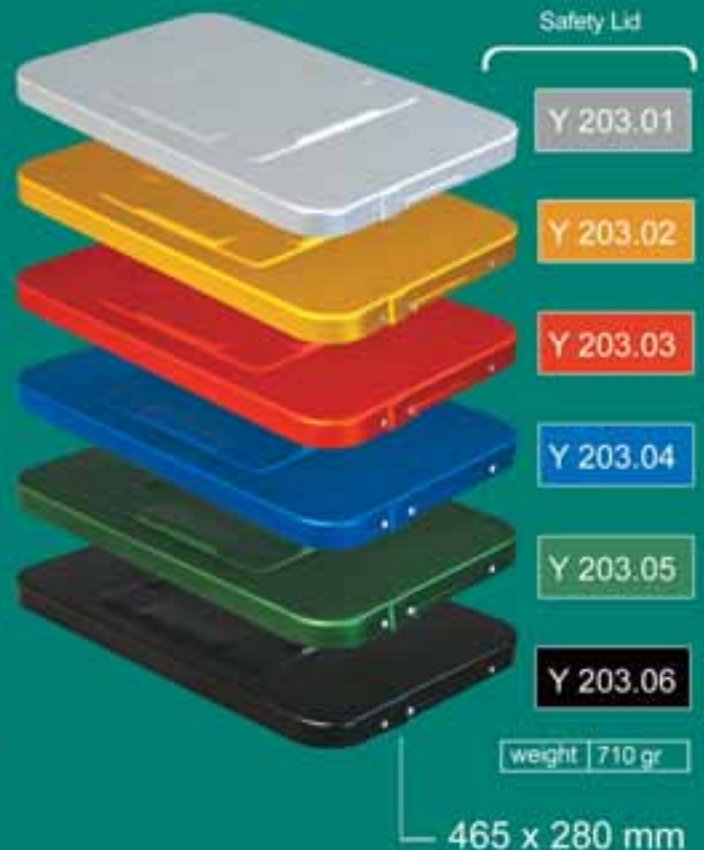

Wire Baskets



	outside dim.	weight
Y 290.03	405 x 255 x 30 mm	972.5 gr
Y 290.05	405 x 255 x 50 mm	988 gr
Y 290.07	405 x 255 x 70 mm	1061 gr
Y 290.10	405 x 255 x 100 mm	1143 gr

Wire Base



Y 293.03	405 x 255 x 30 mm	598 gr
----------	-------------------	--------

Drape Retainer



405 x 255 mm Y 295.00

Drape



140 x 100 cm Y 095.08

basic model

Types and Dimensions

1/2 size containers

Bottom Non Perforated



-  Y 310.10
-  Y 320.10
-  Y 330.10
-  Y 340.10
-  Y 350.10
-  Y 360.10

weight | 1744,5 gr

-  Y 310.13
-  Y 320.13
-  Y 330.13
-  Y 340.13
-  Y 350.13
-  Y 360.13



weight | 1947 gr

-  Y 310.15
-  Y 320.15
-  Y 330.15
-  Y 340.15
-  Y 350.15
-  Y 360.15

weight | 1981 gr

-  Y 310.20
-  Y 320.20
-  Y 330.20
-  Y 340.20
-  Y 350.20
-  Y 360.20

weight | 2101 gr

-  Y 310.26
-  Y 320.26
-  Y 330.26
-  Y 340.26
-  Y 350.26
-  Y 360.26

weight | 2483,5 gr



outside dim. | 285 x 280 x 100 mm
inside dim. | 262 x 260 x 82 mm



outside dim. | 285 x 280 x 135 mm
inside dim. | 262 x 260 x 116 mm



outside dim. | 285 x 280 x 150 mm
inside dim. | 262 x 260 x 132 mm



outside dim. | 285 x 280 x 200 mm
inside dim. | 262 x 260 x 182 mm



outside dim. | 285 x 280 x 260 mm
inside dim. | 262 x 260 x 238 mm

Bottom Perforated









-  Y 311.10
-  Y 321.10
-  Y 331.10
-  Y 341.10
-  Y 351.10
-  Y 361.10

weight | 1890,5 gr

-  Y 311.13
-  Y 321.13
-  Y 331.13
-  Y 341.13
-  Y 351.13
-  Y 361.13







weight | 2125 gr

-  Y 311.15
-  Y 321.15
-  Y 331.15
-  Y 341.15
-  Y 351.15
-  Y 361.15

weight | 2462,5 gr

-  Y 311.20
-  Y 321.20
-  Y 331.20
-  Y 341.20
-  Y 351.20
-  Y 361.20

weight | 2513,5 gr



-  Y 311.26
-  Y 321.26
-  Y 331.26
-  Y 341.26
-  Y 351.26
-  Y 361.26

weight | 2657,5 gr

Types and Dimensions

Bottom Non Perforated









-  Y 312.10
-  Y 322.10
-  Y 332.10
-  Y 342.10
-  Y 352.10
-  Y 362.10

weight | 2162,5 gr

-  Y 312.13
-  Y 322.13
-  Y 332.13
-  Y 342.13
-  Y 352.13
-  Y 362.13

weight | 2351 gr

-  Y 312.15
-  Y 322.15
-  Y 332.15
-  Y 342.15
-  Y 352.15
-  Y 362.15

weight | 2394 gr

-  Y 312.20
-  Y 322.20
-  Y 332.20
-  Y 342.20
-  Y 352.20
-  Y 362.20







weight | 2560 gr

-  Y 312.26
-  Y 322.26
-  Y 332.26
-  Y 342.26
-  Y 352.26
-  Y 362.26







weight | 2930 gr

Bottom Perforated









-  Y 313.10
-  Y 323.10
-  Y 333.10
-  Y 343.10
-  Y 353.10
-  Y 363.10







weight | 2309,5 gr

-  Y 313.13
-  Y 323.13
-  Y 333.13
-  Y 343.13
-  Y 353.13
-  Y 363.13







weight | 2466 gr

-  Y 313.15
-  Y 323.15
-  Y 333.15
-  Y 343.15
-  Y 353.15
-  Y 363.15

weight | 2583 gr

-  Y 313.20
-  Y 323.20
-  Y 333.20
-  Y 343.20
-  Y 353.20
-  Y 363.20

weight | 2785,5 gr

-  Y 313.26
-  Y 323.26
-  Y 333.26
-  Y 343.26
-  Y 353.26
-  Y 363.26

weight | 3069,5 gr

outside dim.	285 x 280 x 100 mm
inside dim.	262 x 260 x 82 mm



outside dim.	285 x 280 x 135 mm
inside dim.	262 x 260 x 116 mm



outside dim.	285 x 280 x 150 mm
inside dim.	262 x 260 x 132 mm



outside dim.	285 x 280 x 200 mm
inside dim.	262 x 260 x 182 mm



outside dim.	285 x 280 x 260 mm
inside dim.	262 x 260 x 238 mm

bottoms and lids

Bottom Non Perforated



Bottom Perforated



	outside dim.	inside dim.	weight
Y 305.10	285 x 280 x 100 mm	262 x 262 x 82 mm	1096 gr
Y 305.13	285 x 280 x 135 mm	262 x 262 x 120 mm	1284 gr
Y 305.15	285 x 280 x 150 mm	262 x 262 x 134 mm	1327 gr
Y 305.20	285x 280 x 200 mm	262x 262 x 185 mm	1447 gr
Y 305.26	285 x 280 x 260 mm	262 x 262 x 240 mm	1817 gr

	outside dim.	inside dim.	weight
Y 306.10	285 x 280 x 100 mm	262 x 262 x 82 mm	1242 gr
Y 306.13	285 x 280 x 135 mm	262 x 262 x 120 mm	1398 gr
Y 306.15	285 x 280 x 150 mm	262 x 262 x 134 mm	1471 gr
Y 306.20	285x 280 x 200 mm	262x 262 x 185 mm	1672 gr
Y 306.26	285 x 280 x 260 mm	262 x 262 x 240 mm	2000 gr

Types and Dimensions

Lid Perforated



Safety Lid



Special Accessories

Wire Baskets



	outside dim.	weight
Y 390.03	255 x 245 x 30 mm	637,5 gr
Y 390.05	255 x 245 x 50 mm	648,5 gr
Y 390.07	255 x 245 x 70 mm	691 gr
Y 390.10	255 x 245 x 100 mm	756,5 gr

Wire Base



	outside dim.	weight
Y 393.00	258 x 258 x 30 mm	351 gr

Special Accessories

Drape Retainer



255 x 255 mm Y 395.00

Drape

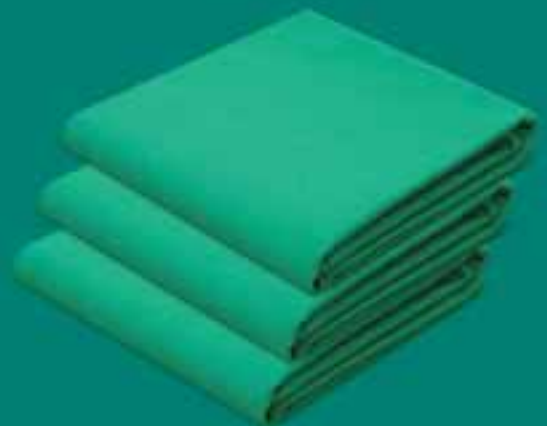

90 x 60 cm Y 095.04
 90 x 80 cm Y 095.05
 130 x 45 cm Y 095.06
 130 x 60 cm Y 095.07

Basic Model Types and Dimensions

Bottom Non Perforated



- Y 110.62
- Y 120.62
- Y 130.62
- Y 140.62
- Y 150.62
- Y 160.62

weight | 3,857 gr



outside dim.	600 x 400 x 120 mm
inside dim.	550 x 350 x 100 mm
weight	2916 gr / 2634 gr

Bottom Perforated



- Y 111.62
- Y 121.62
- Y 131.62
- Y 141.62
- Y 151.62
- Y 161.62

weight | 4101 gr

- Y 110.68
- Y 120.68
- Y 130.68
- Y 140.68
- Y 150.68
- Y 160.68

weight | 4043,5 gr



outside dim.	600 x 400 x 180 mm
inside dim.	550 x 350 x 160 mm

- Y 111.68
- Y 121.68
- Y 131.68
- Y 141.68
- Y 151.68
- Y 161.68

weight | 4581,5 gr

Special Accessories Wire Baskets



Y 190.55

470 X 337 x 51 mm



Y 191.60

533 X 337 X 101 mm

Bottom Non Perforated

Types and Dimensions

Bottom Perforated



	outside dim.	inside dim.	weight
Y 105.62	600 X 400 X 120 mm	550 x 350 x 100 mm	2.189 gr
Y 105.68	600 X 400 X 180 mm	550 x 350 x 160 mm	2375 gr

	outside dim.	inside dim.	weight
Y 106.62	600 X 400 X 120 mm	550 x 350 x 100 mm	2.431 gr
Y 106.68	600 X 400 X 180 mm	550 x 350 x 160 mm	2911 gr

Types and Dimensions

600 X 400 mm

Lid Perforated

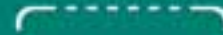

Y 100.51

Y 100.52

Y 100.53

Y 100.54

Y 100.55

Y 100.56







weight 1.668 gr

Flat containers







Types and Dimensions

Bottom Non Perforated



-  Y 310.05
-  Y 320.05
-  Y 330.05
-  Y 340.05
-  Y 350.05
-  Y 360.05

weight | 1285 gr

-  Y 310.08
-  Y 320.08
-  Y 330.08
-  Y 340.08
-  Y 350.08
-  Y 360.08

weight | 1377 gr







Bottom Perforated



outside dim.	285 x 280 x 55 mm
inside dim.	270 x 270 x 33 mm



outside dim.	285 x 280 x 85 mm
inside dim.	270 x 270 x 64 mm

-  Y 311.08
-  Y 321.08
-  Y 331.08
-  Y 341.08
-  Y 351.08
-  Y 361.08

weight | 1529 gr

Bottom Non Perforated



Bottom Perforated



Lid Perforated









	outside dim.	inside dim.	weight
Y 305.05	285 x 280 x 55 mm	270 x 270 x 33 mm	611 gr
Y 305.08	285 x 280 x 85 mm	270 x 270 x 64 mm	703 gr
Y 306.08	285 x 280 x 85 mm	270 x 270 x 64 mm	857 gr

weight 674 gr

285 x 280 mm

Special Accessories
Wire Baskets

255 x 245 x 30 mm Y 390.03
255 x 245 x 50 mm Y 390.05

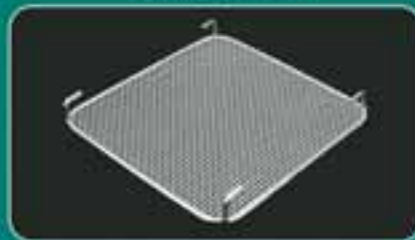
Wire Base

Y 393.00 245 x 255 x 30 mm 351 gr

Silicone Mat

245 x 245 mm Y 851.00

Drape Retainer

255 x 255 mm Y 395.00

Drape







90 x 60 cm Y 095.04
90 x 80 cm Y 095.05

Mini containers





Types and Dimensions

Bottom Non Perforated









-  Y 410.04
-  Y 420.04
-  Y 430.04
-  Y 440.04
-  Y 450.04
-  Y 460.04

weight | 510.5 gr

-  Y 410.07
-  Y 420.07
-  Y 430.07
-  Y 440.07
-  Y 450.07
-  Y 460.07

weight | 567.5 gr

-  Y 410.10
-  Y 420.10
-  Y 430.10
-  Y 440.10
-  Y 450.10
-  Y 460.10







weight | 625.5 gr

Bottom Perforated



-  Y 411.04
-  Y 421.04
-  Y 431.04
-  Y 441.04
-  Y 451.04
-  Y 461.04

weight | 589 gr

-  Y 411.07
-  Y 421.07
-  Y 431.07
-  Y 441.07
-  Y 451.07
-  Y 461.07

weight | 630 gr

-  Y 411.10
-  Y 421.10
-  Y 431.10
-  Y 441.10
-  Y 451.10
-  Y 461.10

weight | 625 gr



outside dim.	300 x 140 x 40 mm
inside dim.	280 x 130 x 27 mm



outside dim.	300 x 140 x 70 mm
inside dim.	280 x 130 x 55 mm



outside dim.	300 x 140 x 100 mm
inside dim.	280 x 130 x 84 mm

Bottom Non Perforated



Bottom Perforated



Lid Perforated



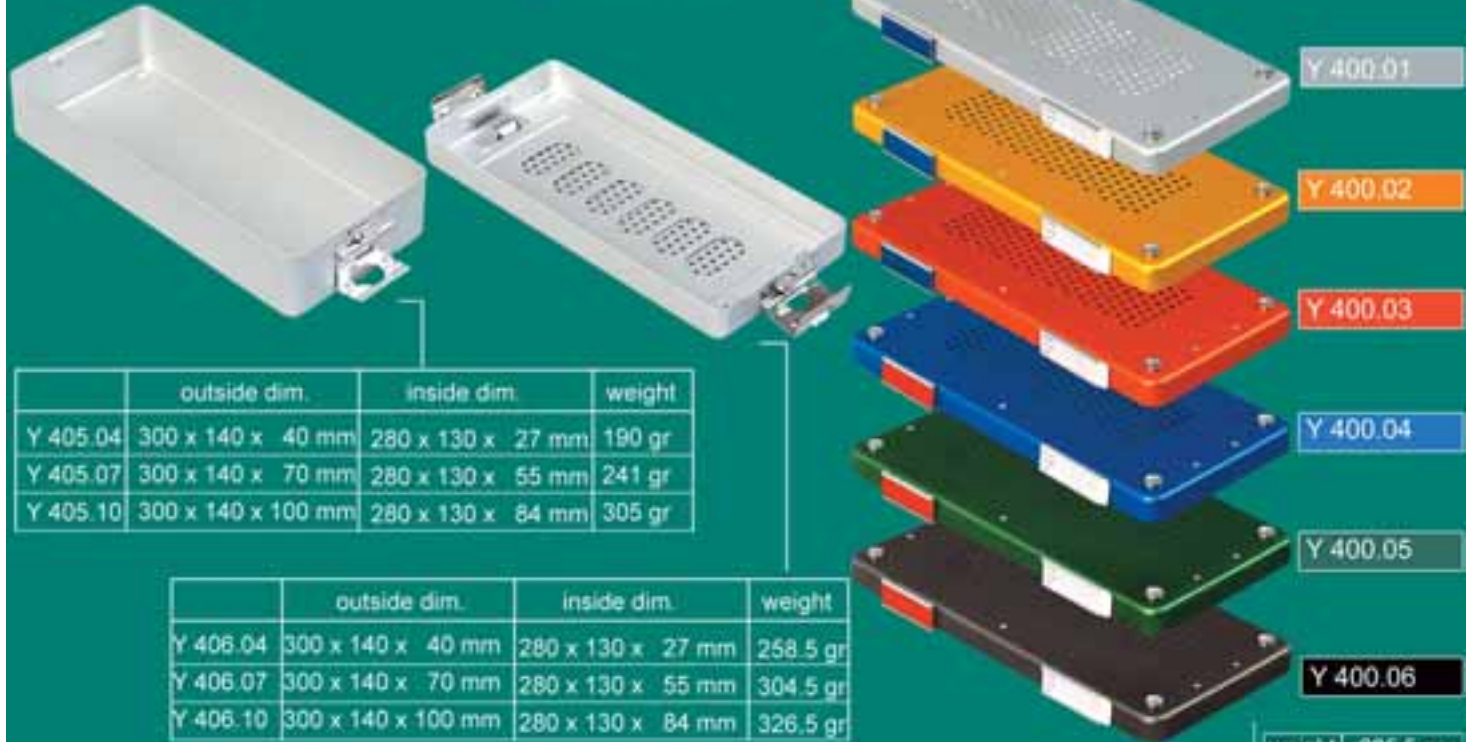

	outside dim.	inside dim.	weight
Y 405.04	300 x 140 x 40 mm	280 x 130 x 27 mm	190 gr
Y 405.07	300 x 140 x 70 mm	280 x 130 x 55 mm	241 gr
Y 405.10	300 x 140 x 100 mm	280 x 130 x 84 mm	305 gr

	outside dim.	inside dim.	weight
Y 406.04	300 x 140 x 40 mm	280 x 130 x 27 mm	258.5 gr
Y 406.07	300 x 140 x 70 mm	280 x 130 x 55 mm	304.5 gr
Y 406.10	300 x 140 x 100 mm	280 x 130 x 84 mm	326.5 gr

Y 400.01	weight	325.5 gr
Y 400.02		
Y 400.03		
Y 400.04		
Y 400.05		
Y 400.06		

300 x 140 mm

Special Accessories

Silicone Mat

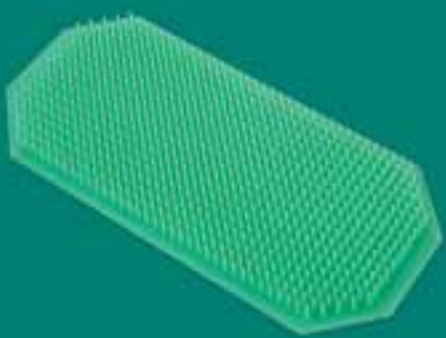

	outside dim.	weight
Y 850.00	270 x 125 mm	121 gr

Drape Retainer



Y 495.00	280 x 125 mm
----------	--------------

Drape



Y 095.01	60 x 40 cm
----------	------------

Types and Dimensions

Lid and Bottom Perforated

 Y 510.04
weight 783 gr

outside dim.	310 x 190 x 40 mm
inside dim.	280 x 182 x 35 mm

 Y 510.06
weight 862 gr

outside dim.	310 x 190 x 65 mm
inside dim.	280 x 182 x 55 mm

 Y 510.13
weight 1022 gr

outside dim.	310 x 190 x 130 mm
inside dim.	280 x 182 x 124 mm

Bottom Perforated



	outside dim.	inside dim.	weight
Y 506.04	310 x 190 x 40 mm	280 x 182 x 35 mm	341,5 gr
Y 506.06	310 x 190 x 65 mm	280 x 182 x 55 mm	415 gr
Y 506.13	310 x 190 x 130 mm	280 x 182 x 124 mm	570 gr

Lid Perforated



	outside dim.	weight
Y 500.01	310 x 190 mm	417.5 gr
Y 500.02	310 x 190 mm	424 gr

Special Accessories
Drape Retainer

Y 595.00 310 x 190 mm

Drape

Y 095.01	60 x 40 cm
Y 095.02	65 x 65 cm
Y 095.03	85 x 85 cm

Types and Dimensions

Lid Perforated - Bottom Perforated (Non Filter)



- Y 612.07
- Y 622.07
- Y 632.07
- Y 642.07
- Y 652.07
- Y 662.07

weight 654 gr

outside dim.	500 x 155 x 75 mm
inside dim.	495 x 155 x 75 mm



- Y 610.06
- Y 620.06
- Y 630.06
- Y 640.06
- Y 650.06
- Y 660.06

weight 368 gr

outside dim.	310 x 138 x 65 mm
inside dim.	300 x 138 x 65 mm

Scopy containers

Types and Dimensions

Lid Perforated - Bottom Perforated (Non Filter)

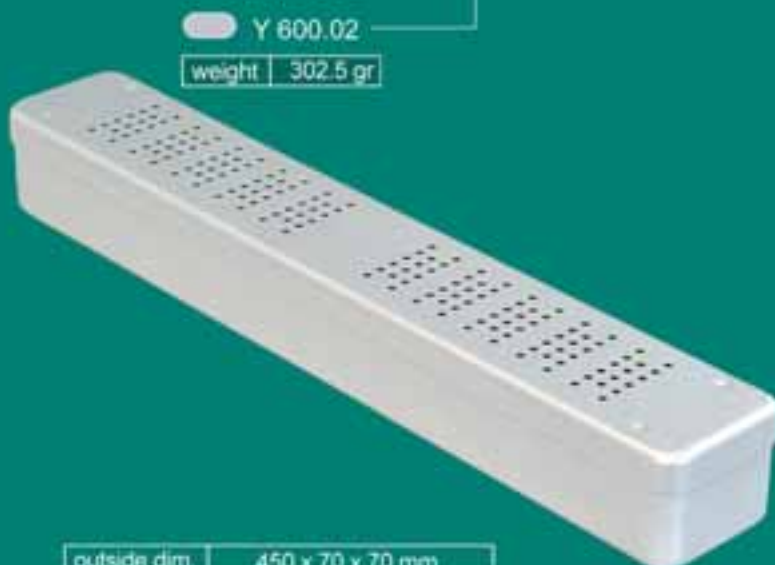

Y 600.02
weight 302.5 gr

outside dim.	450 x 70 x 70 mm
inside dim.	450 x 70 x 60 mm

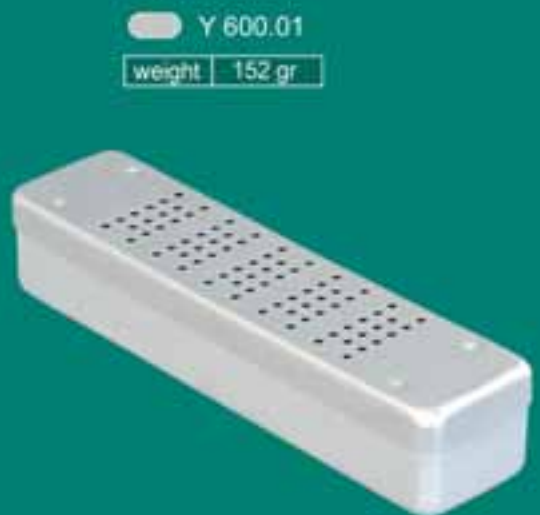

Y 600.01
weight 152 gr

outside dim.	250 x 60 x 50 mm
inside dim.	250 x 55 x 50 mm

Types and Dimensions

Lid And Bottom Non Perforated



outside dim.	285 x 280 x 100 mm
inside dim.	262 x 260 x 82 mm



	Y 315.10
	Y 325.10
	Y 335.10
	Y 345.10
	Y 355.10
	Y 365.10
weight	1677,5 gr

outside dim.	285 x 280 x 150 mm
inside dim.	262 x 260 x 132 mm



	Y 315.15
	Y 325.15
	Y 335.15
	Y 345.15
	Y 355.15
	Y 365.15
weight	1929 gr

outside dim.	580 x 280 x 150 mm
inside dim.	548 x 258 x 130 mm



	Y 115.15
	Y 125.15
	Y 135.15
	Y 145.15
	Y 155.15
	Y 165.15
weight	2883,5 gr

Bottom

Bottom Non Perforated



Y 105.15	580 x 280 x 150 mm	2108 gr
----------	--------------------	---------



Y 305.10	285 x 280 x 150 mm	1096 gr
Y 305.15	285 x 280 x 150 mm	1327 gr

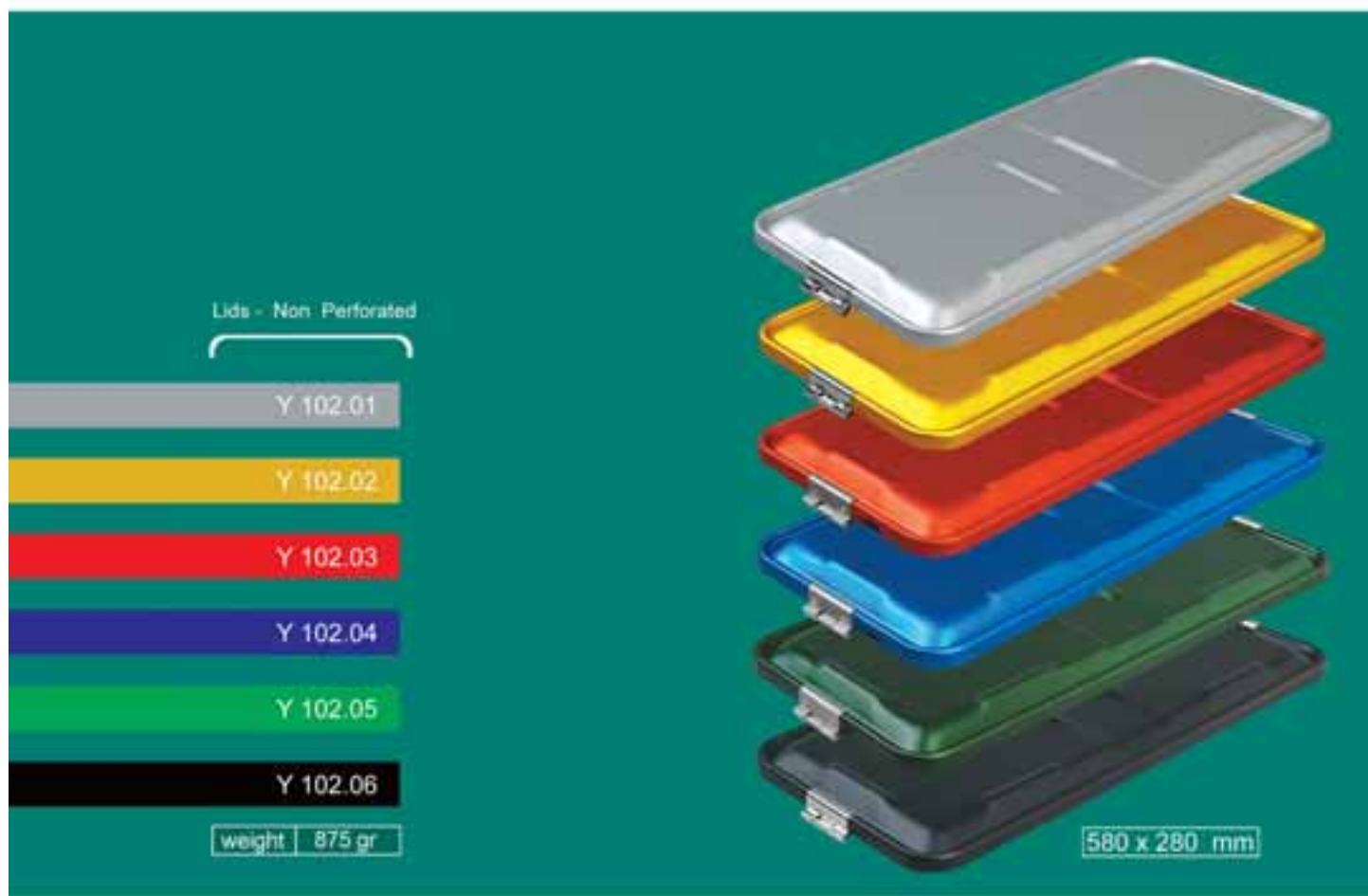



Y 882.00

Y 882.00

Brush container. For 20 brushes

240 x 275 x 70 mm

Stainless steel

Brushes are taken out by rotating the handle under the container.

Containers are supplied together with wall mounting fixtures.



Y 880.00



Y 880.01



Y 880.02

Y 880.00 - 04

Brush container. For 20 brushes

240 x 275 x 70 mm

Aluminium

Brushes are taken out by rotating the handle under the container.
Containers are supplied together with wall mounting fixtures.

Y 880.03



Y 880.04

Disposable paper filters



Y 800.00
Pack of 100
For 1/1, 3/4 and
Half Size Containers



Y 800.01
Single textile
For 1/1, 3/4 and
Half Size Containers



Y 802.00
Pack of 100
For Mini Containers
Y 804.00
Pack of 100
For Dental Containers



Y 802.01
Single textile
For Mini Containers
Y 804.01
Single
For Dental Containers



Y 810.00
Pack of 100
Paper label with indicator
For 1/1, 3/4 and Half Size Containers



Y 812.00
Pack of 100
Paper label with indicator
For Mini and Dental Containers



Y 809.00 For Paper Filter
Y 809.01 For Textile Filter



Y 801.00
Filter Dispenser



Y 819.00
Pack of 100
Plastic Security Seal

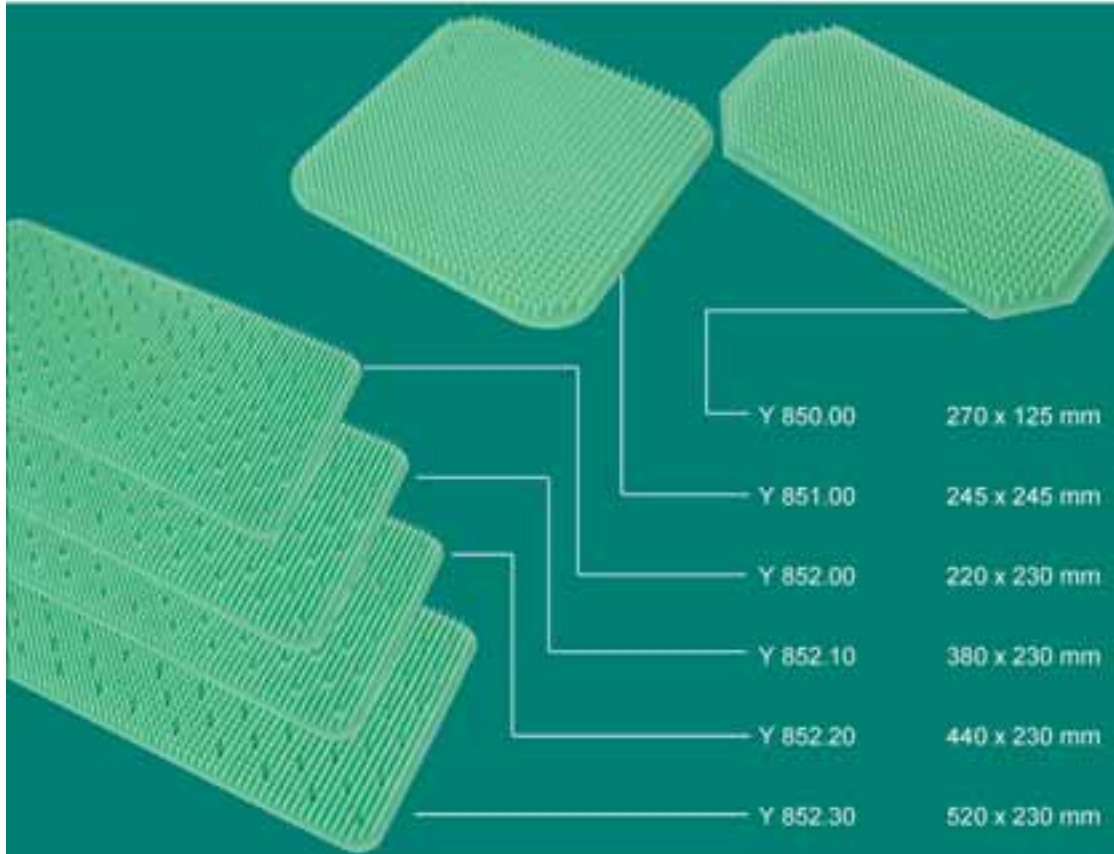

- Y 850.00 270 x 125 mm
- Y 851.00 245 x 245 mm
- Y 852.00 220 x 230 mm
- Y 852.10 380 x 230 mm
- Y 852.20 440 x 230 mm
- Y 852.30 520 x 230 mm

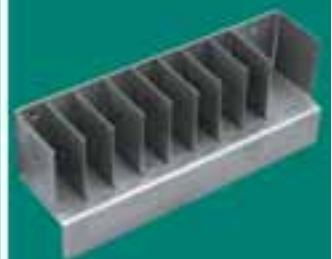

Y 829.00
Dispenser for identification labels

Grey	Y 820.01
Yellow	Y 820.02
Red	Y 820.03
Blue	Y 820.04
Green	Y 820.05
Black	Y 820.06

Coloured identification labels
Printed to your specifications,
max. 16 letters.



Y 849.20
24X28X25
Ø 7-12 mm



Y 849.21
24X28X29
Ø 12-16 mm



Y 849.22
24X28X31
Ø 16-26 mm



Y 849.23
24X28X40
Ø 26-36 mm



Y 849.24
24X28X44
Ø 36-45 mm



Y 849.00
Fixation Clamp
50X20X12 mm



Y 849.01
Fixation Clamp
65X20X20 mm



Y 841.00 230 mm
Y 841.01 470 mm
Sliding Rails with
Securing Screws



Y 842.00 230 mm
Y 842.01 470mm
Limiting Bar with
Securing Screws



Y 830.01
Holding Pin
For Partition Sheets



Y 830.00
Holding Pin
For Wire Baskets



Partition Sheets
Stainless Steel

Y 831.05 50X20 mm
Y 831.13 130X20 mm
Y 831.22 225X20 mm
Y 831.46 460X20 mm



Y 845.00
Spiral Holding



Y 847.00
Double
Spiral Holding



Y 840.00
Divider, to be
used with
Y 841.00



Carrying



Y 890.00
Trolley
975 x 670 x 1015 mm



Y 891.00
Trolley
1007 x 675 x 1405 mm



SETS



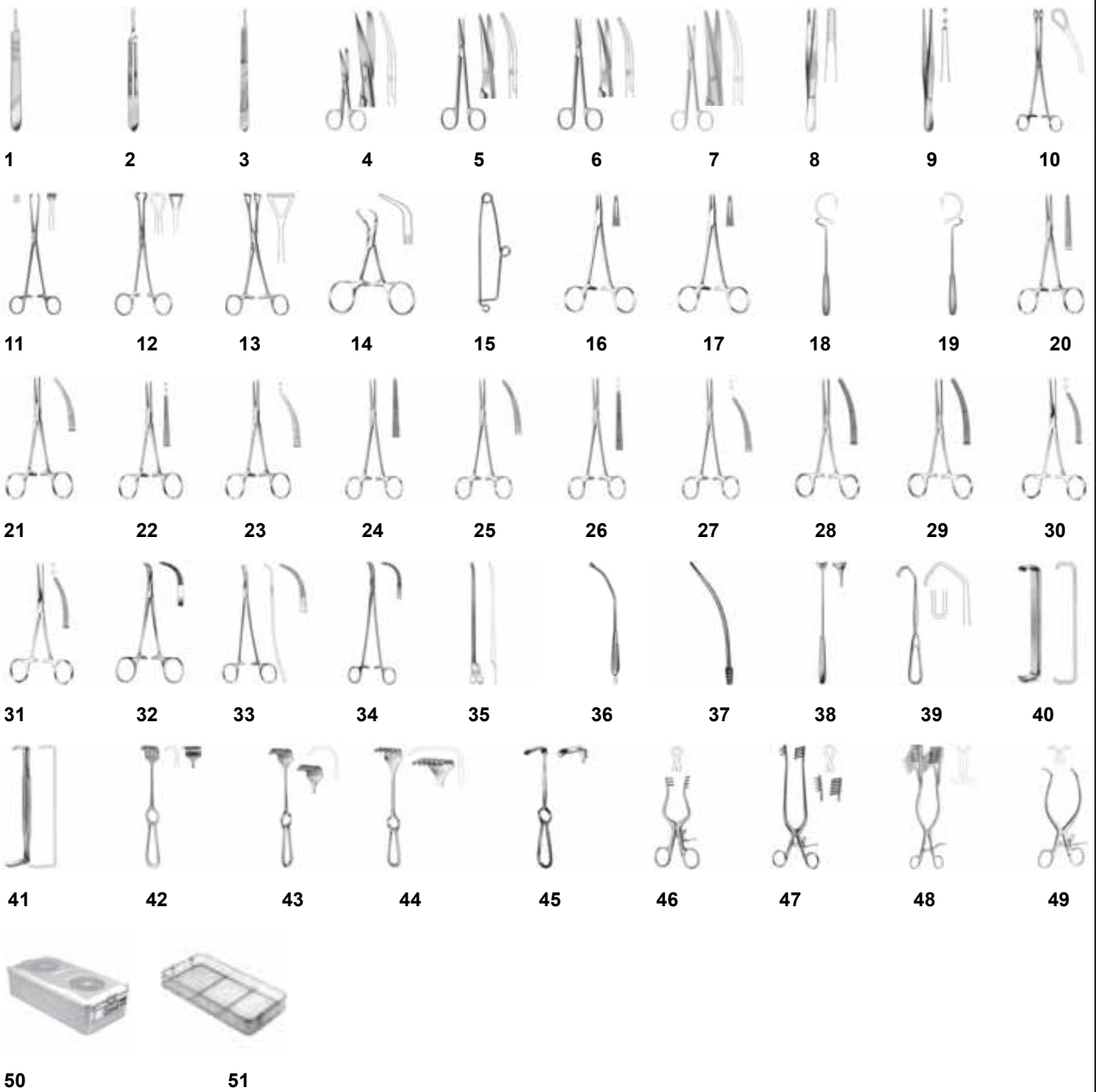

1	1	B 030.01	Scalpel Handle 3 No 13.5 cm
2	1	B 040.01	Scalpel Handle 4 No 13.5 cm
3	1	B 040.02	Scalpel Handle 4 No 21 cm
4	1	C 311.03	Standart Scissors Curved 14 cm
5	1	C 421.00	Metzenbaum Scissors Curved 16 cm
6	2	C 421.01	Metzenbaum Scissors Curved 18 cm
7	2	C 459.00	Mayo - Lexer Scissors Curved 17 cm
8	2	D 240.03	Standart Forcep Straight 16 cm
9	2	D 360.04	Standart Forcep Teeth 16 cm
10	2	E 087.00	Foerster - Ballanger Dressing Forcep 24 cm
11	1	E 150.00	Allis Tissue Grasping Forcep, 15.5 cm
12	1	E 174.00	Babcook Organ and Tissue Grasping Forcep, 16 cm
13	1	E 187.00	Duval Atraumatic Forcep 20 cm
14	16	E 430.01	Backhouse Towell Clamp 13 cm
15	8	E 481.00	Mayo Safety Pin, 14 cm
16	2	F 230.01	Mayo - Hegar Needle Holder 18 cm
17	1	F 230.02	Mayo - Hegar Needle Holder 20 cm
18	1	F 440.00	Deschamp Left 24 cm
19	1	F 441.00	Deschamp Right 24 cm
20	2	G 240.00	Crile Haemostatic Forcep Straight 14 cm
21	4	G 241.00	Crile Haemostatic Forcep Curved 14 cm
22	4	G 244.00	Crile Haemostatic Forcep Straight Teeth 14 cm
23	8	G 245.00	Crile Haemostatic Forcep Curved Teeth 14 cm
24	2	G 264.00	Crile Haemostatic Forcep Straight 16 cm
25	4	G 265.00	Crile Haemostatic Forcep Curved 16 cm
26	4	G 268.00	Crile Haemostatic Forcep Straight Teeth 16 cm
27	8	G 269.00	Crile Haemostatic Forcep Curved 16 cm
28	2	G 431.01	Kocher Haemostatic Forcep Curved 18 cm
29	2	G 431.02	Kocher Haemostatic Forcep Curved 20 cm
30	3	G 449.01	Kocher Haemostatic Forcep Curved Teeth 18 cm
31	3	G 449.02	Kocher Haemostatic Forcep Curved Teeth 20 cm
32	1	G 616.01	Baby - Mixer Dissecting Forcep 18 cm
33	1	G 618.02	Dissecting Forcep 21 cm
34	1	G 654.00	Mixer Dissecting Forcep 23 cm
35	2	J 012.00	Doyen Probe 14 cm
36	1	J 300.00	Yankauer Suction Tube 28.5 cm
37	1	J 352.00	Suction Tube 16 cm
38	1	K 274.01	Cushing Retractor 25 cm
39	1	K 279.00	Cushing Retractor 22 cm
40	1	K 311.00	Farabeuf Retractor 15 cm
41	1	K 342.00	Us -army Retractor 22 cm
42	2	K 432.03	Volkman Retractor 22 cm
43	2	K 438.00	Korte -Wagner Retractor 28 cm
44	2	K 444.02	Israel Retractor Blunt 23 cm
45	2	K 452.05	Kocher - Langenbeck Retractor 22 cm
46	2	L 305.00	Weitlaner Self-Retaining Retractor Sharp 13 cm
47	2	L 353.02	Weitlaner Self-Retaining Retractor Sharp 25 cm
48	2	L 377.02	Beckmann - Eaton Self-Retaining Retractor 32 cm
49	2	L 409.00	Gelpy Self-Retaining Retractor 17 cm
50	2	Y 110.15	Container 580 X 280 X 150 cm
51	2	Y 191.05	Wire Basket 540 X 250 X 50 cm

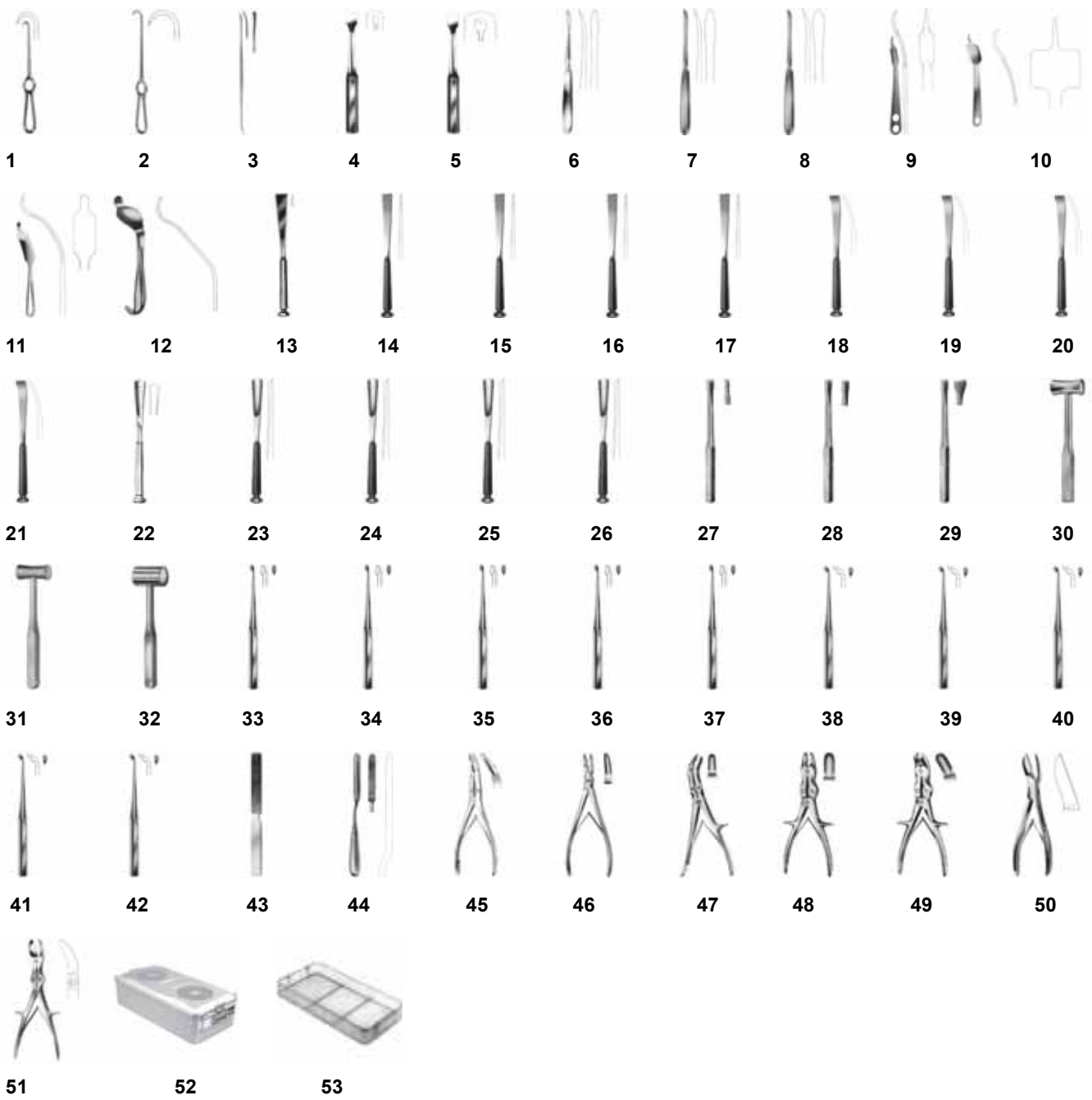

1	2	K 402.00	Kocher Retractor 22 cm
2	2	K 408.00	Volkman Retractor 24.5 cm
3	1	M 115.01	Davis Raspatorie 24 cm
4	1	M 300.02	Key Periost Bone Lever 13 mm 18 cm
5	1	M 300.04	Key Periost Bone Lever 25 mm 20 cm
6	1	M 340.01	Quervain Elevator 6 mm 20 cm
7	1	M 341.01	Langenbeck Elevator 8 mm 20 cm
8	1	M 341.02	Langenbeck Elevator 10 mm 20 cm
9	2	M 411.02	Hohman Bone Lever 24 cm
10	2	M 416.02	Verbrugge - Muller Bone Lever 25.5 cm
11	2	M 421.03	Lange - Hohmann Bone Lever 29 cm
12	2	M 435.02	Bennet Bone Lever 25 cm
13	1	M 650.03	Stille Osteotome Straight 8 mm 20 cm
14	1	M 650.04	Stille Osteotome Straight 10 mm 20 cm
15	1	M 650.06	Stille Osteotome Straight 15 mm 20 cm
16	1	M 650.07	Stille Osteotome Straight 20 mm 20 cm
17	1	M 650.08	Stille Osteotome Straight 25 mm 20 cm
18	1	M 654.04	Stille Osteotome 10 mm 20 cm
19	1	M 654.06	Stille Osteotome 15 mm 20 cm
20	1	M 654.07	Stille Osteotome 20 mm 20 cm
21	1	M 654.08	Stille Osteotome 25 mm 20 cm
22	1	M 656.03	Stille Gouge 8 mm 20 cm
23	1	M 656.04	Stille Gouge 10 mm 20 cm
24	1	M 656.06	Stille Gouge 15 mm 20 cm
25	1	M 656.07	Stille Gouge 20 mm 20 cm
26	1	M 656.08	Stille Gouge 25 mm 20 cm
27	1	M 754.01	Tamper 8 mm 20 cm
28	1	M 754.02	Tamper 10 x 5 mm 20 cm
29	1	M 754.03	Tamper 8 x 3 mm 20 cm
30	1	M 818.01	Bergmann Mallet 150 gr 15 cm
31	1	M 818.02	Bergmann Mallet 300 gr 23 cm
32	1	M 820.02	Ombredanne Mallet 550 gr 24 cm
33	1	N 210.01	Brun Bone Curette 000 No Straight 22 cm
34	1	N 210.03	Brun Bone Curette 0 No Straight 22 cm
35	1	N 210.05	Brun Bone Curette 2 No Straight 22 cm
36	1	N 210.07	Brun Bone Curette 4 No Straight 22 cm
37	1	N 210.09	Brun Bone Curette 6 No Straight 22 cm
38	1	N 211.01	Brun Bone Curette 000 No Curved 22 cm
39	1	N 211.03	Brun Bone Curette 0 No Curved 22 cm
40	1	N 211.05	Brun Bone Curette 2 No Curved 22 cm
41	1	N 211.07	Brun Bone Curette 4 No Curved 22 cm
42	1	N 211.09	Brun Bone Curette 6 No Curved 22 cm
43	1	N 335.01	Raspatorie 22 cm
44	1	N 340.01	Raspatorie 25 cm
45	1	P 304.01	Mayfield Rongeur 17 cm
46	1	P 309.01	Rottgen- Ruskin Rongeur 24 cm
47	1	P 315.01	Stille Rongeur 23 cm
48	1	P 320.01	Luer -Stille Rongeur 22 cm
49	1	P 321.01	Luer -Stille Rongeur 22 cm
50	1	P 359.03	Liston Scissors 19 cm
51	1	P 377.01	Liston Scissors 28 cm
52	2	Y 110.15	Container 580 x 280 x 150 mm
53	2	Y 191.05	Wire Basket 540 x 250 x 50 mm



1



2



3



4



5



6



7



8



9



10



11



12



13



14



15



16



17



18



19



20



21



22



23



24



25



26



27



28



29

1	1	P 121.00	Bone Holding Forcep 13.5 cm
2	1	P 123.00	Bone Holding Forcep 13.5 cm
3	2	P 171.00	Verbrugge Bone Holding Forcep 17 cm
4	2	P 172.01	Verbrugge Bone Holding Forcep 25 cm
5	2	P 172.03	Verbrugge Bone Holding Forcep 27 cm
6	2	P 180.00	Lowman Bone Holding Forcep 18.5 cm
7	2	P 180.01	Lowman Bone Holding Forcep 20 cm
8	1	T 623.00	Jewett Bending Iron 20 cm
9	1	T 623.01	Jewett Bending Iron 20 cm
10	1	T 625.00	Plate Bending and Contouring Device
11	1	V 620.04	Screwdriver 2.5 mm 25 cm
12	2	V 620.05	Screwdriver 3.5 mm 25 cm
13	1	V 621.03	Phillips Screwdriver 25 cm
14	1	V 623.01	Screwdriver Straight 25 cm
15	2	V 645.02	Bone Tap 3.5 mm 17 cm
16	1	V 645.03	Bone Tap 4.0 mm 20 cm
17	1	V 645.04	Bone Tap 4.5 mm 22 cm
18	1	V 648.00	Screw Depth Gauges 22 cm
19	1	V 652.00	Drill Guide Handle
20	1	V 657.00	Drill Guide 3,2 mm, 4 cm
21	1	V 657.01	Drill Guide 3,2 mm, 4 cm
22	1	V 657.02	Drill Guide 3.2 mm 6 cm
23	1	V 657.03	Drill Guide 3.2 mm 6 cm
24	1	V 666.00	Drill Guide Ø 6.5 mm
25	1	V 667.01	Tissue Protector Sheath 4.5 mm
26	1	V 669.00	Tissue Protector Sheath 3.5 mm
27	1	Y 110.15	Container 580 x 280 x 150 mm
28	1	Y 191.05	Wire Basket 540 x 250 x 50 mm
29	1	Y 390.03	Wire Basket 255 x 245 x 30 mm



1



2



3



4



5



6



7



8



9



10



11



12



13



14



15



16



17



18



19



20



21



22



23



24



25



26



27



28



29



30



31



32



33

1	1	T 685.00	Dura Protector 10 cm
2	1	T 688.00	Kuntscher Impactor 13 cm
3	1	T 689.00	Kuntscher Impactor 21 cm
4	1	T 689.01	Kuntscher Impactor 17 cm
5	1	T 690.00	Kuntscher Impactor-Extractor 50 cm
6	1	T 729.00	"T" Wrench, for Malleable Reamers
7	1	V 720.01	Kuntscher Reamer 26 cm
8	1	V 721.00	Kuntscher Reamer 36 cm
9	1	V 725.06	Fixed Reamer 6 mm
10	1	V 725.07	Fixed Reamer 7 mm
11	1	V 725.08	Fixed Reamer 8 mm
12	1	V 725.09	Fixed Reamer 9 mm
13	1	V 725.10	Fixed Reamer 10 mm
14	1	V 725.11	Fixed Reamer 11 mm
15	1	V 725.12	Fixed Reamer 12 mm
16	1	V 725.13	Fixed Reamer 13 mm
17	1	V 725.14	Fixed Reamer 14 mm
18	1	V 725.15	Fixed Reamer 15 mm
19	1	V 725.16	Fixed Reamer 16 mm
20	1	V 727.06	Malleable Reamer 6 mm
21	1	V 727.07	Malleable Reamer 7 mm
22	1	V 727.08	Malleable Reamer 8 mm
23	1	V 727.09	Malleable Reamer 9 mm
24	1	V 727.10	Malleable Reamer 10 mm
25	1	V 727.11	Malleable Reamer 11 mm
26	1	V 727.12	Malleable Reamer 12 mm
27	1	V 727.13	Malleable Reamer 13 mm
28	1	V 727.14	Malleable Reamer 14 mm
29	1	V 727.15	Malleable Reamer 15 mm
30	1	V 727.16	Malleable Reamer 16 mm
31	1	V 728.05	Kuntscher Wire Guide 4 mm 50 cm
32	1	Y 110.13	Container 580 x 280 x 135 mm
33	2	Y 191.05	Wire Basket 540 x 250 x 50 mm



1



2



3



4



5



6



7



8



9



10



11



12



13

1	1	B 515.00	Smille Meniscus Knives Right 17 cm
2	1	B 516.00	Smille Meniscus Knives Left 17 cm
3	1	B 517.00	Smille Meniscus Knives Straight 17 cm
4	1	K 470.00	Smille Meniscus Retractor 20 x 20 mm 17 cm
5	1	K 470.01	Smille Meniscus Retractor 32 x 20 mm 17 cm
6	1	K 470.02	Smille Meniscus Retractor 41 x 20 mm 17 cm
7	1	K 470.03	Smille Meniscus Retractor 57 x 20 mm 17 cm
8	1	K 470.04	Smille Meniscus Retractor 12 x 60 mm 17 cm
9	1	K 477.00	Blount Meniscus Retractor 40 x 5 mm
10	1	P 660.00	Bircher - Ganske Meniscus Forcep 20 cm
11	1	P 664.00	Martin Meniscus Forcep 20 cm
12	1	Y 310.10	Container 285 x 280 x 100 mm
13	1	Y 390.05	Wire Basket 250 x 245 x 50 mm

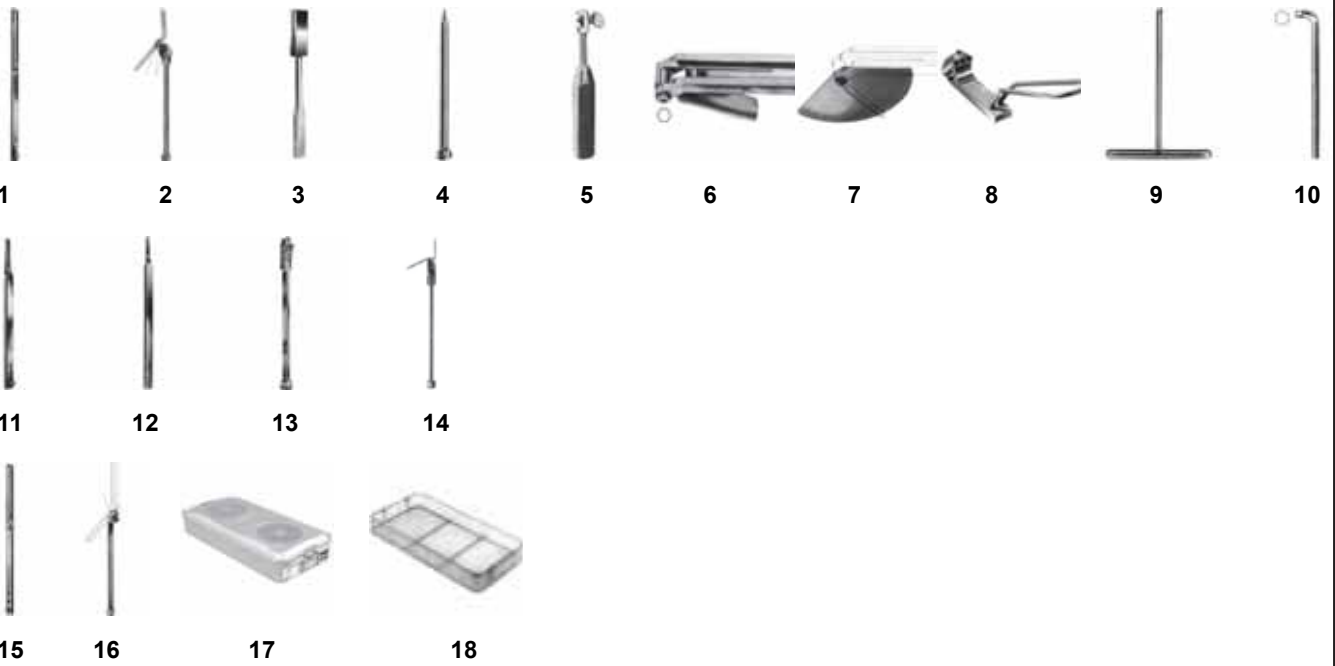

“” Plak için;

1	1	T 656.00	Impactor 26 cm
2	1	T 653.00	Impactor-Extractor 27 cm
3	1	T 663.00	Slotted Mallet 29 cm
4	1	T 660.00	Impactor 21 cm
5	1	T 661.00	Guide Handle 19 cm
6	1	T 668.00	Sliding Guide 3.5 mm
7	1	T 669.00	Angular Guide for Chisel Guide
8	1	T 665.00	Drill Guide
9	1	V 702.00	“ T ” Wrench 18 cm
10	1	V 701.00	“ L ” Wrench 12 cm

“” Plak için;

11	1	T 651.00	Impactor 12 mm 26 cm
12	1	T 650.00	Impactor 8 mm 26 cm
13	1	T 652.00	Impactor-Extractor 26 cm
14	1	T 654.00	Impactor-Extractor 26 cm

“” Plak için;

15	1	T 657.00	Impactor 10 mm 28 cm
16	1	T 655.00	Impactor-Extractor 26.5 cm
17	1	Y 110.10	Container 580 x 280 x 100 mm
18	1	Y 191.05	Wire Basket 540 x 250 x 50 mm



1



2



3



4



5



6



7



8



9

1	1	T 640.00	Angle Measuring Instrument, 10 cm
2	1	V 690.00	Uzatma Mili, 14 cm
3	1	V 691.00	Reamer, 18 cm
4	1	V 692.00	Reamer, 23 cm
5	1	V 693.00	Tap
6	1	V 694.00	" T " Handle, 25 cm
7	1	V 695.00	Pin Fixing rod, 30 cm
8	1	V 696.00	Guide Wire, 28 cm
9	1	Y 410.07	Container 300 x 135 x 70 mm



1



2



3



4



5



6



7



8



9



10



11



12



13



14



15



16



17



18



19



20



21



22



23



24



25



26



27

1	1	F 334.00	Needle Holder HM 15 cm
2	1	F 336.00	Needle Holder HM 15 cm
3	1	F 458.00	Obwegeser Reamer 19.5 cm
4	1	F 532.01	Wire Guide 22.5 cm
5	1	F 531.01	Wire Guide 24 cm
6	1	F 530.02	Demel Wire Guide 28.5 cm
7	1	F 522.00	Demel Wire Tightening and Twisting Forcep 27 cm
8	1	F 526.00	Jordan Wire Catcher 18 cm
9	1	F 525.00	Jordan Wire Twister 17 cm
10	1	F 527.00	Jordan Probe, Cannulated 17 cm
11	1	P 613.00	Wire Holding Forcep 17 cm
12	1	P 614.00	Wire Holding Forcep 19 cm
13	1	P 632.00	Wire Cutting Scissors HM 14 cm
14	1	P 643.00	Wire Cutting Forcep HM 23 cm
15	1	F 529.00	Wire Soft 0.2 mm
16	1	F 529.01	Wire Soft 0.3 mm
17	1	F 529.02	Wire Soft 0.4 mm
18	1	F 529.03	Wire Soft 0.5 mm
19	1	F 529.04	Wire Soft 0.6 mm
20	1	F 529.05	Wire Soft 0.7 mm
21	1	F 529.06	Wire Soft 0.8 mm
22	1	F 529.07	Wire Soft 0.9 mm
23	1	F 529.08	Wire Soft 1.0 mm
24	1	F 529.09	Wire Soft 1.2 mm
25	1	F 529.10	Wire Soft 1.5 mm
26	1	Y 310.15	Container 285 x 280 x 150 mm
27	2	Y 390.05	Wire Basket 250 x 245 x 50 mm



1



2



3



4



5



6



7



8



9

1	1	M 711.03	Gouge, 9 mm, 22 cm
2	1	P 675.00	Screw Removing Forcep, 20 cm
3	1	V 710.00	Screw Removing Tap, 2.5 mm
4	1	V 710.01	Screw Removing Tap, 3.2 mm
5	1	V 711.00	Screwdriver, 3.5 mm, Hexagonal, 18 cm
6	1	V 712.00	Screw Edge Cutter, 10 cm
7	1	V 712.10	Reamer, 17 cm
8	1	V 713.00	Reverse Inserewing Arm, 10 cm
9	1	Y 410.07	Container 300 x 135 x 70 mm

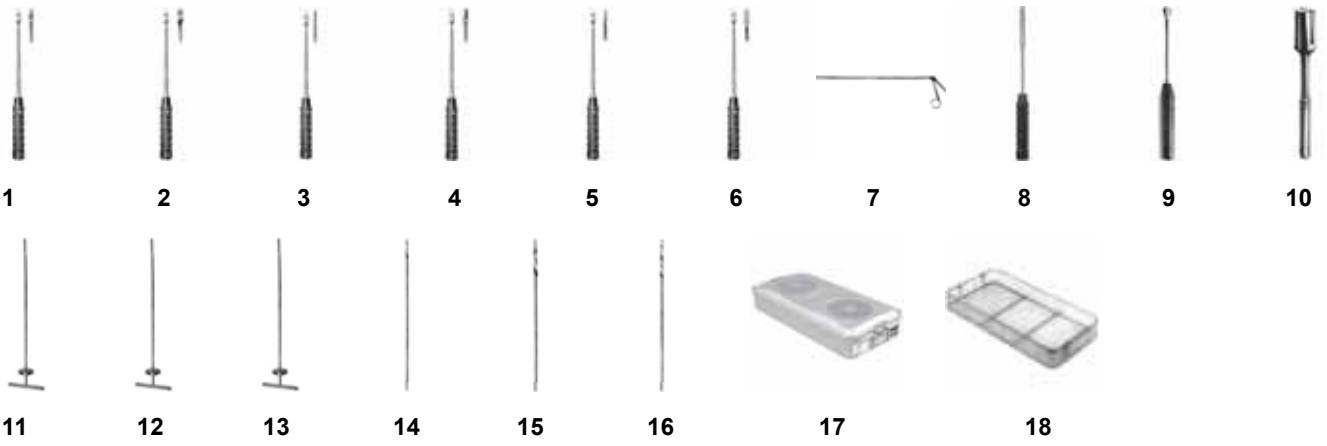

1	1	M 745.00	Osteotome 5 mm 35 cm
2	1	M 745.02	Osteotome 10 mm 35 cm
3	1	M 746.00	Gouge 5 mm 35 cm
4	1	M 746.02	Gouge 10 mm 35 cm
5	1	M 747.00	Gouge 5 mm 35 cm
6	1	M 747.02	Gouge 10 mm 35 cm
7	1	R 780.00	Cement Forceps 40 cm
8	1	T 720.00	Cement Pusher Round 20 cm
9	1	T 721.00	Cement Pusher Square 28 cm
10	1	T 725.00	Mallet 30 cm
11	1	T 726.00	Cement Extractor 0.7 mm 40 cm
12	1	T 726.01	Cement Extractor 0.9 mm 40 cm
13	1	T 726.02	Cement Extractor 0.11 mm 40 cm
14	1	V 735.00	Cement Scissors 0.6 mm 40 cm
15	1	V 736.00	Cement Scissors 0.8 mm 40 cm
16	1	V 737.00	Cement Scissors 0.10 mm 40 cm
17	1	Y 110.10	Container 580 x 280 x 100 mm
18	1	Y 191.05	Wire Basket 540 x 250 x 50 mm



1



2



3



4



5



6



7



8



9



10



11



12



13



14

1	1	D 575.00	Forcep, 16 cm
2	2	P 617.00	Wire Twisting Forcep, 13 cm
3	1	P 640.00	Reil Wire Cutting Forcep, 17.5 cm
4	1	P 683.00	Plate Bender, 15 cm
5	1	T 745.00	Screwdriver, 15 cm
6	1	T 746.00	Screwdriver, 15 cm
7	1	T 749.00	Depth Measuring Instrument, 20 cm
8	1	V 750.00	Drill, 1.5 mm
9	1	V 752.00	Drill Guide, 20 cm
10	1	V 754.00	Drill Guide, 23 cm
11	1	V 754.05	Drill Guide, Ø 2.5 mm
12	1	V 754.06	Drill Guide, Ø 2.5 mm
13	1	Y 310.10	Container, 285 x 280 x100 mm
14	1	Y 390.05	Wire Basket, 250 x 245 x 50 mm



1



2



3



4



5



6



7



8

1	1	M 813.01	Mallet 19 cm
2	1	T 680.00	Extractor 40 cm
3	1	T 682.00	Impactor 20 cm
4	1	T 683.00	Holder 20 cm
5	1	V 715.00	Drill 0.5 mm 20 cm
6	1	V 716.00	Drill 0.7 mm 20 cm
7	1	Y 310.10	Container 285 x 280 x 100 mm
8	1	Y 390.05	Wire Basket 250 x 245 x 50 mm



1



2



3



4



5



6



7



8



9



10



11



12



13



14



15



16



17



18



19



20



21



22



23



24



25



26



27



28

1	1	M 219.01	Joseph Raspatorie 16 cm
2	1	M 240.01	Adson Raspatorie 8 mm 17 cm
3	1	M 241.01	Adson Raspatorie 7 mm 17 cm
4	1	M 242.01	Adson Raspatorie 7 mm 17 cm
5	1	M 243.01	Adson Raspatorie 7 mm 17 cm
6	2	M 401.00	Buck - Gramcko Bone Lever 16 cm
7	2	M 402.00	Bone Lever 15 cm
8	2	M 405.00	Bone Lever 15 cm
9	1	M 615.01	Partsch Chisel 4 mm 14 cm
10	1	M 615.02	Partsch Chisel 6 mm 14 cm
11	1	M 615.03	Partsch Chisel 8 mm 14 cm
12	1	M 615.04	Partsch Chisel 10 mm 14 cm
13	1	M 615.05	Partsch Chisel 12 mm 14 cm
14	1	M 620.01	Partsch Gouge 3 mm 14 cm
15	1	M 620.02	Partsch Gouge 4 mm 14 cm
16	1	M 620.03	Partsch Gouge 5 mm 14 cm
17	1	M 620.04	Partsch Gouge 6 mm 14 cm
18	1	M 812.01	Hajek Impactor 22 cm
19	1	N 180.01	Williger Bone Curette 17 cm
20	1	N 326.01	Fomon Raspatorie 21 cm
21	1	P 100.00	Bone Holding Forcep9.5 cm
22	1	P 102.00	Bone Holding Forcep13.5 cm
23	1	P 107.01	Bone Holding Forcep20 cm
24	1	P 142.00	Bone Holding Forcep
25	1	P 300.01	Bohler Bone Rongeur
26	1	P 368.00	Mc Indoe Bone Cutting Forcep
27	1	Y 310.15	Container 285 x 280 x150 mm
28	2	Y 390.05	Wire Basket 250 x 245 x 50 mm

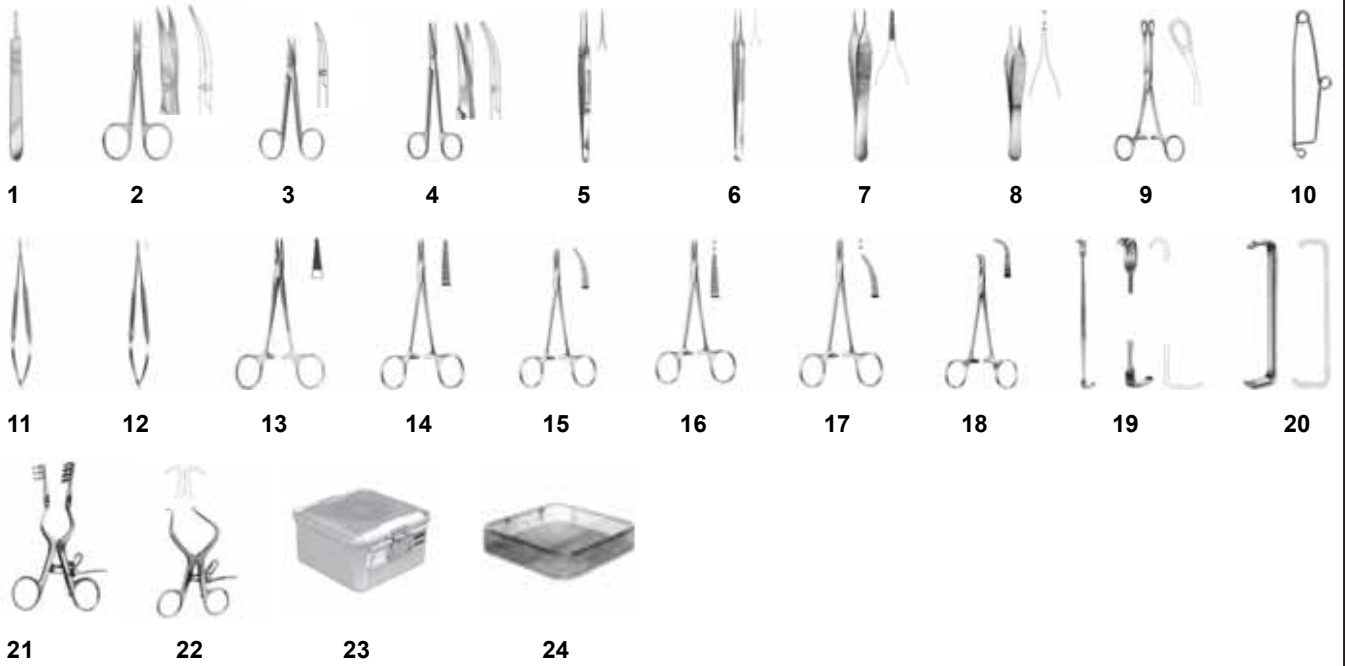

1	1	B 030.01	Scalpel Handle 3 No 12 cm
2	1	C 223.00	Scissors Curved 9.5 cm
3	1	C 391.00	Stevens Scissors Curved 10.5 cm
4	1	C 421.00	Metzenbaum Scissors Curved 16 cm
5	1	D 126.00	Lazar Micro Forcep Uc 0.5 mm 15 cm
6	1	D 128.00	Lazar Micro Forcep Uc 0.8 mm 15 cm
7	1	D 205.00	Adson Forcep Straight 12 cm
8	1	D 323.00	Adson Forcep Teeth 12 cm
9	2	E 083.00	Foerster - Ballanger Dressing Forcep 18 cm
10	1	E 481.00	Mayo Safety Pin 14 cm
11	1	F 132.00	Micro Needle Holder 18 cm
12	1	F 133.00	Micro Needle Holder 18 cm
13	1	F 325.00	Halsey Needle Holder 13 cm
14	2	G 214.00	Halsted - Mosquito Forcep Straight 12.5 cm
15	4	G 215.00	Halsted - Mosquito Forcep Curved 12.5 cm
16	2	G 218.00	Halsted - Mosquito Forcep Straight Teeth 12.5 cm
17	4	G 219.00	Halsted - Mosquito Forcep Curved Teeth 12.5 cm
18	1	G 617.00	Baby - Adson Dissecting Forcep 14 cm
19	2	K 242.00	Senn - Miller Retractor 17 cm
20	1	K 310.00	Farabeuf Retractor 13 cm
21	2	L 330.02	Adson - Baby Self-Retaining Retractor 14 cm
22	2	L 405.00	De Bakey Self-Retaining Retractor 12 cm
23	1	Y 310.10	Container 285 x 280 x 100 mm
24	2	Y 390.07	Wire Basket 255 x 245 x 70 mm



1



2



3



4



5

1	1	M 818.01	Bergman Mallet 23 cm
2	1	T 670.00	Blount Inserter 20 cm
3	1	T 671.01	Blount Extractor 19 cm
4	1	T 673.00	Extractor 20 cm
5	1	Y 410.07	Container 300 x 135 x 70 mm



1	2	K 408.00	Volkman Bone Retractor, Sharp, 24.5 cm
2	2	K 608.02	Kocher - Wagner Retractor, 64x25 mm 28 cm
3	2	M 427.01	Bone Lever, 32 cm
4	2	M 429.02	Bone Lever, 32 cm
5	1	M 434.01	Femoral Retractor, 38 cm
6	1	M 720.05	Chisel, Straight, 26 cm
7	1	M 721.04	Chisel, Curved, 26 cm
8	1	M 735.02	Gouge, 16 mm, 26 cm
9	1	N 600.00	Curette, 37 mm, 25 cm
10	1	N 605.00	Curette, 30 cm
11	1	N 608.00	Curette, 34 cm
12	1	T 700.00	Guide, 50 cm
13	1	T 700.02	Metal Head, 22 cm
14	1	T 700.03	Metal Head, 28 cm
15	1	T 700.04	Metal Head, 32 cm
16	1	T 700.06	Teflon Head, 22 cm
17	1	T 700.07	Teflon Head, 28 cm
18	1	T 700.08	Teflon Head, 32 cm
19	1	T 702.00	Pusher, 14 cm
20	1	T 705.00	Pusher, 20 cm
21	1	T 710.00	Austin Graft Al1c1, 21 cm
22	1	T 711.00	Extractor, 25 cm
23	1	T 714.00	More Prostheses Extractor, 50 cm
24	1	V 730.00	" T " Guide Handle, 21 cm
25	1	V 730.01	Reamer Handle, 23 cm
26	1	V 730.09	Acetabulum Reamer, 44 mm
27	1	V 730.10	Acetabulum Reamer, 46 mm
28	1	V 730.11	Acetabulum Reamer, 48 mm
29	1	V 730.12	Acetabulum Reamer, 50 mm
30	1	V 730.13	Acetabulum Reamer, 52 mm
31	1	V 730.14	Acetabulum Reamer, 56 mm
32	1	Y 110.15	Container, 580 x 280 x 150 mm
33	2	Y 191.05	Wire Basket, 540 x 250 x 50 mm



NUMERICAL INDEX



Kat. No. Cat. No.	Sayfa. Page.	Kat. No. Cat. No.	Sayfa. Page.	Kat. No. Cat. No.	Sayfa. Page.	Kat. No. Cat. No.	Sayfa. Page.
A 890.00	233	B 188.00	5	C 120.00	6	C 313.01	11
A 890.30	233	B 500.00	204	C 121.00	6	C 313.02	11
A 890.45	233	B 501.00	204	C 124.00	7	C 313.03	11
A 890.70	233	B 502.00	204	C 125.00	7	C 313.04	11
A 891.00	233	B 504.00	204	C 126.00	7	C 313.05	11
A 891.30	233	B 506.00	204	C 130.00	7	C 313.06	11
A 891.45	233	B 507.00	204	C 130.01	7	C 314.01	12
A 891.70	233	B 510.00	205	C 131.00	7	C 314.02	12
A 900.00	233	B 511.00	205	C 131.01	7	C 314.03	12
A 900.30	233	B 512.00	205	C 140.00	7	C 314.04	12
A 900.45	233	B 515.00	205	C 141.00	7	C 314.05	12
A 900.70	233	B 516.00	205	C 142.00	7	C 315.01	12
A 901.00	233	B 517.00	205	C 150.00	7	C 315.02	12
A 901.30	233	B 550.00	228	C 151.00	7	C 315.03	12
A 901.45	233	B 550.01	228	C 152.00	7	C 315.04	12
A 901.70	233	B 550.02	228	C 153.00	7	C 390.00	13
		B 550.03	228	C 155.00	7	C 391.00	13
		B 550.08	228	C 220.00	8	C 392.00	13
		B 550.09	228	C 221.00	8	C 393.00	13
B 010.00	2	B 550.10	228	C 222.00	8	C 418.00	13
B 012.00	2	B 550.11	228	C 223.00	8	C 418.01	13
B 014.00	2	B 550.12	228	C 230.00	8	C 419.00	13
B 016.00	2	B 550.13	228	C 231.00	8	C 420.00	14
B 018.00	2	B 550.14	228	C 232.00	8	C 420.01	14
B 030.00	3	B 550.15	228	C 233.00	8	C 420.02	14
B 030.01	3	B 550.16	228	C 234.00	8	C 421.00	14
B 030.02	3	B 550.17	228	C 237.00	9	C 421.01	14
B 032.00	2	B 550.18	228	C 238.00	9	C 421.02	14
B 033.00	2	B 552.01	229	C 239.00	9	C 440.00	14
B 034.00	3	B 552.02	229	C 250.00	9	C 440.01	14
B 034.01	3	B 552.03	229	C 251.00	9	C 440.02	14
B 040.00	4	B 552.08	229	C 258.00	9	C 441.00	14
B 040.01	4	B 552.09	229	C 268.00	9	C 441.01	14
B 040.02	4	B 552.10	229	C 269.00	9	C 441.02	14
B 043.00	4	B 552.11	229	C 310.00	10	C 449.00	15
B 043.01	4	B 552.12	229	C 310.01	10	C 449.01	15
B 045.00	4	B 552.13	229	C 310.02	10	C 451.00	15
B 141.00	193	B 552.14	229	C 310.03	10	C 452.00	15
B 143.00	193	B 552.15	229	C 310.04	10	C 458.00	15
B 144.00	192	B 552.16	229	C 310.05	10	C 458.01	15
B 145.00	193	B 552.17	229	C 310.06	10	C 459.00	15
B 146.00	192	B 552.18	229	C 310.07	10	C 459.01	15
B 146.01	192			C 310.08	10	C 459.02	15
B 146.02	192			C 311.01	10	C 630.00	16
B 146.03	192			C 311.02	10	C 631.00	16
B 160.00	192	C 102.00	6	C 311.03	10	C 632.00	16
B 163.00	192	C 103.00	6	C 311.04	10	C 633.00	16
B 175.00	188	C 106.00	6	C 311.05	10	C 653.00	17
B 176.00	188	C 107.00	6	C 311.06	10	C 653.01	17
B 177.00	188	C 108.00	6	C 311.07	10	C 654.00	17
B 179.00	188	C 110.00	6	C 312.02	11	C 656.00	17
B 180.00	5	C 112.00	6	C 312.03	11	C 658.00	17
B 182.00	5	C 113.00	6	C 312.04	11	C 660.00	13
B 184.00	5	C 116.00	6	C 312.05	11	C 796.00	184
B 186.00	5	C 117.00	6	C 312.06	11	C 798.00	184

Kat. No. Cat. No.	Sayfa. Page.	Kat. No. Cat. No.	Sayfa. Page.	Kat. No. Cat. No.	Sayfa. Page.	Kat. No. Cat. No.	Sayfa. Page.
C 880.00	188	D 260.00	22	D 389.01	26	E 170.00	31
C 882.00	188	D 260.02	22	D 390.00	26	E 171.00	31
C 884.00	188	D 262.00	22	D 390.01	26	E 171.01	31
C 885.00	189	D 262.01	22	D 390.02	26	E 174.00	31
C 886.00	189	D 263.00	22	D 392.00	26	E 174.01	31
		D 263.01	22	D 394.00	26	E 184.00	32
		D 265.00	22	D 396.00	26	E 184.01	32
		D 265.01	22	D 398.00	26	E 186.00	32
D 103.00	18	D 266.00	20	D 503.00	27	E 187.00	32
D 103.01	18	D 266.01	20	D 504.00	27	E 187.01	32
D 104.00	18	D 268.00	22	D 510.00	27	E 189.00	32
D 105.00	18	D 268.01	22	D 510.01	27	E 302.00	33
D 106.00	18	D 320.00	23	D 512.00	27	E 302.01	33
D 108.00	18	D 322.00	23	D 512.01	27	E 311.00	33
D 109.00	18	D 323.00	23	D 513.00	27	E 312.00	33
D 110.00	18	D 324.00	23	D 516.00	27	E 331.00	33
D 113.00	18	D 325.01	23	D 516.01	27	E 331.01	33
D 125.00	18	D 327.00	23	D 516.02	27	E 332.00	33
D 126.00	19	D 329.00	23	D 520.00	27	E 332.01	33
D 126.01	19	D 340.00	23	D 520.01	27	E 402.00	34
D 127.00	19	D 341.00	23	D 570.00	222	E 403.00	34
D 128.00	19	D 341.01	23	D 571.00	222	E 404.00	34
D 130.00	19	D 341.02	23	D 572.00	222	E 420.00	34
D 130.01	19	D 360.00	24	D 575.00	222	E 420.01	34
D 130.02	19	D 360.01	24	D 576.00	222	E 420.02	34
D 131.00	19	D 360.02	24	D 610.00	91	E 430.00	34
D 131.01	19	D 360.03	24			E 430.01	34
D 131.02	19	D 360.04	24			E 430.02	34
D 204.00	20	D 360.05	24			E 440.00	34
D 205.00	20	D 360.06	24	E 019.00	28	E 442.00	34
D 220.00	20	D 360.07	24	E 022.00	28	E 444.00	35
D 220.01	20	D 360.08	24	E 023.00	28	E 450.00	34
D 220.02	20	D 361.00	24	E 030.00	28	E 451.00	34
D 221.02	20	D 361.01	24	E 042.00	28	E 451.01	34
D 225.00	20	D 361.02	24	E 043.00	28	E 480.00	35
D 225.01	20	D 361.03	24	E 044.00	28	E 481.00	35
D 225.02	20	D 362.00	24	E 045.00	28	E 482.00	35
D 225.03	20	D 364.00	24	E 080.00	29		
D 225.04	20	D 365.00	24	E 081.00	29		
D 232.00	21	D 365.01	24	E 082.00	29	F 110.00	46
D 233.00	21	D 366.00	24	E 083.00	29	F 111.00	46
D 238.00	21	D 368.00	25	E 084.00	29	F 114.00	46
D 240.00	21	D 369.00	25	E 085.00	29	F 115.00	46
D 240.01	21	D 370.00	25	E 086.00	29	F 116.00	46
D 240.02	21	D 370.01	25	E 087.00	29	F 117.00	46
D 240.03	21	D 370.02	25	E 143.00	30	F 118.00	46
D 240.04	21	D 370.03	25	E 144.00	30	F 119.00	46
D 240.05	21	D 370.04	25	E 145.00	30	F 124.00	46
D 240.06	21	D 371.00	25	E 150.00	30	F 125.00	46
D 242.00	21	D 371.01	25	E 150.02	30	F 126.00	46
D 244.00	21	D 371.02	25	E 150.04	30	F 127.00	46
D 244.01	21	D 373.00	25	E 150.06	30	F 132.00	46
D 244.02	21	D 387.00	25	E 150.08	30	F 133.00	46
D 244.03	21	D 387.01	25	E 158.00	31	F 134.00	46
D 247.00	21	D 389.00	26	E 159.00	31	F 135.00	46

Kat. No. Cat. No.	Sayfa. Page.	Kat. No. Cat. No.	Sayfa. Page.	Kat. No. Cat. No.	Sayfa. Page.	Kat. No. Cat. No.	Sayfa. Page.
F 203.00	47	F 457.00	191	G 023.00	37	G 427.02	41
F 204.00	47	F 458.00	191	G 024.00	37	G 427.03	41
F 210.00	47	F 459.00	191	G 024.01	37	G 428.00	41
F 215.00	47	F 460.00	191	G 024.02	37	G 428.01	41
F 219.00	47	F 465.00	54	G 024.03	37	G 428.02	41
F 223.01	47	F 465.01	54	G 024.04	37	G 428.03	41
F 223.03	47	F 466.00	54	G 024.05	37	G 428.04	41
F 230.00	47	F 466.01	54	G 024.06	37	G 430.00	42
F 230.01	47	F 481.00	55	G 026.00	37	G 430.01	42
F 230.02	47	F 482.00	55	G 030.00	37	G 430.02	42
F 236.00	48	F 483.00	55	G 030.01	37	G 430.03	42
F 237.00	48	F 484.00	55	G 200.00	38	G 430.04	42
F 239.00	48	F 485.00	55	G 201.00	38	G 431.00	42
F 250.00	51	F 488.00	55	G 204.00	38	G 431.01	42
F 251.00	51	F 489.00	55	G 205.00	38	G 431.02	42
F 285.00	51	F 520.00	180	G 206.00	38	G 431.03	42
F 290.00	51	F 522.00	180	G 207.00	38	G 431.04	42
F 290.01	51	F 525.00	180	G 210.00	38	G 448.00	43
F 325.00	49	F 526.00	180	G 211.00	38	G 448.01	43
F 328.00	49	F 527.00	180	G 214.00	38	G 448.02	43
F 332.00	49	F 529.00	180	G 215.00	38	G 448.03	43
F 334.00	49 / 181	F 529.01	180	G 218.00	38	G 448.04	43
F 336.00	49 / 181	F 529.02	180	G 219.00	38	G 448.05	43
F 337.01	181	F 529.03	180	G 230.00	39	G 449.00	43
F 339.01	181	F 529.04	180	G 231.00	39	G 449.01	43
F 347.00	49	F 529.05	180	G 234.00	39	G 449.02	43
F 347.01	49	F 529.06	180	G 235.00	39	G 449.03	43
F 347.02	49	F 529.07	180	G 240.00	38	G 449.04	43
F 355.00	50	F 529.08	180	G 241.00	38	G 449.05	43
F 355.01	50	F 529.09	180	G 244.00	38	G 614.00	44
F 355.02	50	F 529.10	180	G 245.00	38	G 615.00	44
F 380.00	50	F 530.01	179	G 250.00	39	G 616.00	44
F 380.01	50	F 530.02	179	G 251.00	39	G 616.01	44
F 380.02	50	F 530.03	179	G 254.00	39	G 617.00	44
F 380.03	50	F 531.01	179	G 255.00	39	G 618.00	44
F 381.00	50	F 531.03	179	G 260.00	40	G 618.01	44
F 381.01	50	F 532.01	179	G 261.00	40	G 618.02	44
F 381.02	50	F 533.00	179	G 264.00	40	G 618.03	44
F 389.01	50			G 265.00	40	G 620.00	45
F 389.02	50			G 268.00	40	G 620.01	45
F 389.03	50			G 269.00	40	G 620.02	45
F 424.00	52	G 010.00	37	G 274.00	40	G 620.03	45
F 425.00	52	G 010.01	37	G 275.00	40	G 620.04	45
F 426.00	52	G 010.02	37	G 278.00	40	G 620.05	45
F 427.00	52	G 011.00	37	G 279.00	40	G 620.06	45
F 428.00	52	G 011.01	37	G 280.00	39	G 654.00	45
F 429.00	52	G 011.02	37	G 281.00	39	G 672.00	45
F 432.00	52	G 012.00	37	G 286.00	39	G 672.01	45
F 433.00	52	G 013.00	37	G 300.00	41	G 674.00	45
F 438.00	53	G 013.01	37	G 301.00	41	G 674.01	45
F 439.00	53	G 020.00	37	G 304.00	41	G 883.00	35
F 440.00	53	G 020.01	37	G 305.00	41	G 884.00	35
F 441.00	53	G 021.00	37	G 308.00	41	G 884.01	35
F 445.00	53	G 021.01	37	G 427.00	41	G 884.02	35
F 446.00	53	G 022.00	37	G 427.01	41		

Kat. No. Cat. No.	Sayfa. Page.	Kat. No. Cat. No.	Sayfa. Page.	Kat. No. Cat. No.	Sayfa. Page.	Kat. No. Cat. No.	Sayfa. Page.
H 820.01	229	J 438.03	57	K 310.00	62	K 432.03	68
H 820.02	229	J 438.04	57	K 311.00	62	K 432.04	68
H 821.00	228			K 312.00	62	K 433.00	68
H 821.01	228			K 314.00	62	K 433.01	68
				K 315.00	62	K 433.02	68
		K 104.00	58	K 320.00	63	K 433.03	68
		K 112.01	58	K 320.01	63	K 433.04	68
J 010.00	56	K 112.02	58	K 320.02	63	K 434.00	68
J 010.01	56	K 112.03	58	K 322.01	62	K 434.01	68
J 010.02	56	K 127.00	58	K 325.00	54	K 434.02	68
J 012.00	56	K 137.00	58	K 325.01	64	K 434.03	68
J 015.00	56	K 138.00	58	K 325.02	64	K 435.00	69
J 030.00	56	K 138.01	58	K 325.03	64	K 435.01	69
J 030.01	56	K 176.00	59	K 327.00	63	K 435.02	69
J 030.02	56	K 180.00	59	K 327.01	63	K 435.03	69
J 030.03	56	K 180.01	59	K 328.00	64	K 436.00	69
J 030.04	56	K 180.02	59	K 329.00	64	K 436.01	69
J 031.00	56	K 181.00	59	K 333.00	63	K 436.02	69
J 033.01	56	K 181.01	59	K 337.01	65	K 436.03	69
J 033.07	56	K 181.02	59	K 338.01	72	K 437.00	69
J 033.08	56	K 182.00	59	K 339.01	65	K 438.00	69
J 033.09	56	K 182.01	59	K 339.02	65	K 439.00	69
J 033.10	56	K 182.02	59	K 339.03	65	K 440.00	70
J 033.11	56	K 183.00	59	K 341.00	65	K 442.00	70
J 033.12	56	K 183.02	59	K 342.00	65	K 444.00	70
J 033.15	56	K 195.00	61	K 400.00	66	K 444.01	70
J 033.16	56	K 195.01	61	K 401.00	66	K 444.02	70
J 033.17	56	K 195.02	61	K 402.00	66	K 444.03	70
J 033.18	56	K 221.00	58	K 403.00	66	K 450.01	71
J 033.20	56	K 223.00	58	K 404.00	66	K 450.02	71
J 035.00	56	K 232.00	61	K 405.00	66	K 450.03	71
J 035.01	56	K 235.00	61	K 406.00	66	K 451.01	71
J 035.02	56	K 237.00	59	K 407.00	66	K 451.02	71
J 038.00	56	K 240.00	59	K 408.00	66	K 451.03	71
J 038.01	56	K 241.00	59	K 410.00	67	K 451.04	71
J 219.00	57	K 242.00	59	K 411.00	67	K 451.05	71
J 220.02	57	K 251.00	59	K 415.00	67	K 451.06	71
J 240.01	233	K 252.00	59	K 415.01	67	K 452.01	71
J 240.02	233	K 263.00	61	K 415.02	67	K 452.02	71
J 241.01	233	K 263.01	61	K 415.03	67	K 452.03	71
J 241.02	233	K 274.00	61	K 420.00	67	K 452.04	71
J 255.01	232	K 274.01	61	K 420.01	67	K 452.05	71
J 255.02	232	K 274.02	61	K 420.02	67	K 452.06	71
J 256.01	232	K 276.00	61	K 420.03	67	K 452.07	71
J 256.02	232	K 276.01	61	K 430.00	68	K 452.08	71
J 257.01	232	K 279.00	65	K 430.01	68	K 452.09	71
J 257.02	232	K 280.01	59	K 430.02	68	K 452.10	71
J 258.01	232	K 280.02	59	K 430.03	68	K 454.00	72
J 258.02	232	K 280.03	59	K 431.00	68	K 454.01	72
J 300.00	57	K 283.01	59	K 431.01	68	K 456.00	72
J 301.00	57	K 284.00	59	K 431.02	68	K 460.00	72
J 304.00	57	K 284.01	59	K 431.03	68	K 460.01	72
J 306.00	57	K 284.02	59	K 432.00	68	K 460.02	72
J 308.00	57	K 284.03	59	K 432.01	68	K 460.03	72
J 352.00	57	K 285.01	59	K 432.02	68	K 460.04	72

Kat. No. Cat. No.	Sayfa. Page.	Kat. No. Cat. No.	Sayfa. Page.	Kat. No. Cat. No.	Sayfa. Page.	Kat. No. Cat. No.	Sayfa. Page.
K 470.00	207	L 330.15	85	L 392.00	87	L 463.10	90
K 470.01	207	L 331.02	79	L 394.00	87	L 461.01	90
K 470.02	207	L 331.04	79	L 405.00	85	L 463.00	90
K 470.03	207	L 331.06	79	L 406.00	85	L 463.02	90
K 470.04	207	L 333.00	77	L 408.00	85	L 463.11	90
K 477.00	207	L 335.00	78	L 409.00	85	L 463.12	90
K 479.00	207	L 336.00	78	L 430.01	92	L 463.13	90
K 480.00	73	L 338.00	79	L 430.03	92	L 463.14	90
K 480.01	73	L 339.00	80	L 430.10	92	L 463.15	90
K 480.02	73	L 340.00	77	L 430.11	92	L 463.16	90
K 481.00	73	L 343.00	80	L 431.01	92	L 463.17	90
K 550.06	228	L 344.00	80	L 431.03	92	L 463.20	90
K 551.00	229	L 345.00	80	L 432.01	92	L 463.21	90
K 601.00	73	L 347.00	81	L 432.03	92	L 463.22	90
K 602.00	73	L 348.00	80	L 435.00	92	L 463.23	90
K 602.01	73	L 350.00	80	L 450.00	88	L 463.24	90
K 605.01	74	L 351.00	80	L 450.04	88	L 463.25	90
K 605.02	74	L 352.00	85	L 450.06	88	L 463.26	90
K 605.04	74	L 353.01	81	L 450.08	88	L 463.27	90
K 605.05	74	L 353.02	81	L 450.10	88	L 463.30	90
K 605.06	74	L 353.03	81	L 450.12	88	L 463.31	90
K 607.00	74	L 354.01	81	L 450.14	88	L 463.32	90
K 607.01	74	L 354.02	81	L 450.15	88	L 463.33	90
K 607.02	74	L 354.03	81	L 450.16	88	L 463.34	90
K 608.00	75	L 356.00	81	L 450.18	88	L 463.35	90
K 608.01	75	L 360.00	81	L 450.20	88	L 463.36	90
K 608.02	75	L 362.00	82	L 452.00	88	L 463.37	90
K 608.03	75	L 364.00	82	L 452.01	88	L 465.00	91
		L 365.01	82	L 452.04	88	L 465.01	91
		L 366.02	83	L 452.06	88	L 467.00	91
		L 368.02	83	L 452.08	88	L 467.01	91
L 300.00	76	L 370.02	83	L 452.10	88	L 469.00	91
L 301.00	76	L 371.02	83	L 452.12	88	L 469.01	91
L 302.00	76	L 375.02	84	L 455.00	89	L 470.00	91
L 304.00	76	L 377.02	84	L 455.01	89	L 470.01	91
L 305.00	76	L 378.01	84	L 455.05	89	L 470.02	91
L 306.00	76	L 379.01	84	L 455.06	89	L 470.03	91
L 308.00	76	L 380.00	86	L 455.10	89	L 470.04	91
L 309.00	76	L 380.01	86	L 455.12	89	L 470.06	91
L 312.00	77	L 380.02	86	L 455.14	89	L 470.07	91
L 313.00	77	L 380.03	86	L 455.16	89	L 470.08	91
L 314.00	80	L 380.04	86	L 455.18	89	L 470.09	91
L 318.00	78	L 380.05	86	L 455.19	89	L 470.10	91
L 320.00	78	L 381.00	86	L 455.20	89	L 471.00	91
L 321.00	78	L 381.01	86	L 455.26	89	L 471.01	91
L 322.01	78	L 381.02	86	L 455.28	89	L 471.02	91
L 323.01	78	L 381.03	86	L 455.30	89	L 471.03	91
L 325.00	79	L 381.04	86	L 455.32	89	L 471.04	91
L 326.00	79	L 381.05	86	L 455.40	89	L 471.06	91
L 327.00	77	L 384.01	87	L 455.45	89	L 471.07	91
L 328.00	77	L 384.02	87	L 455.51	89	L 471.08	91
L 329.00	77	L 386.00	87	L 455.61	89	L 471.09	91
L 330.02	79	L 386.01	87	L 460.00	90	L 471.10	91
L 330.04	79	L 386.02	87	L 460.01	90	L 472.00	91
L 330.06	79	L 390.00	87	L 461.00	90	L 472.01	91

Kat. No. Cat. No.	Sayfa. Page.	Kat. No. Cat. No.	Sayfa. Page.	Kat. No. Cat. No.	Sayfa. Page.	Kat. No. Cat. No.	Sayfa. Page.
L 472.02	91	L 487.11	93	M 214.00	97	M 341.02	103
L 472.03	91	L 487.13	93	M 214.01	97	M 343.01	103
L 472.04	91	L 487.15	93	M 215.00	97	M 345.01	104
L 472.05	91	L 488.06	93	M 216.00	97	M 346.01	104
L 472.08	91	L 488.07	93	M 219.01	97	M 348.01	104
L 472.09	91	L 488.08	93	M 240.01	98	M 349.02	104
L 472.10	91	L 488.09	93	M 241.01	98	M 400.00	105
L 472.11	91	L 488.10	93	M 242.01	98	M 401.00	105
L 472.12	91	L 488.11	93	M 243.01	98	M 402.00	105
L 472.13	91	L 488.12	93	M 245.01	98	M 402.01	105
L 472.14	91	L 490.00	94	M 245.02	98	M 403.00	105
L 472.15	91	L 490.01	94	M 247.01	103	M 405.00	105
L 472.16	91	L 490.05	94	M 250.01	98	M 406.00	105
L 472.17	91	L 490.06	94	M 252.01	98	M 410.01	106
L 474.00	91	L 490.07	94	M 253.01	98	M 411.02	106
L 474.01	91	L 490.08	94	M 260.00	99	M 412.01	106
L 474.10	91	L 490.09	94	M 261.00	99	M 412.02	106
L 474.11	91	L 491.00	94	M 263.00	99	M 413.01	107
L 474.12	91	L 491.01	94	M 264.00	99	M 413.03	107
L 474.13	91	L 491.05	94	M 265.01	99	M 415.02	108
L 474.14	91	L 491.06	94	M 266.01	99	M 416.02	108
L 474.15	91	L 491.07	94	M 270.01	99	M 418.02	108
L 474.16	91	L 491.08	94	M 271.01	99	M 420.02	109
L 474.17	91	L 491.09	94	M 275.01	100	M 421.02	109
L 474.18	91	L 494.00	95	M 276.01	100	M 421.03	109
L 474.19	91	L 495.00	95	M 278.01	100	M 423.02	110
L 474.21	91	L 497.00	95	M 278.02	100	M 424.02	110
L 474.22	91	L 498.00	95	M 278.03	100	M 425.02	111
L 474.23	91	L 499.00	95	M 278.04	100	M 427.01	112
L 474.24	91	L 895.00	217	M 278.05	100	M 429.02	112
L 474.25	91			M 300.01	100	M 430.02	111
L 474.26	91			M 300.02	100	M 431.02	111
L 474.27	91			M 300.03	100	M 434.01	112
L 474.28	91	M 090.00	229	M 300.04	100	M 435.01	113
L 474.29	91	M 090.01	229	M 305.01	100	M 435.02	113
L 474.30	91	M 091.00	229	M 305.02	100	M 437.01	113
L 482.00	94	M 091.01	229	M 305.03	100	M 437.02	113
L 482.01	94	M 092.00	229	M 310.01	101	M 437.03	113
L 484.00	94	M 092.01	229	M 311.01	101	M 440.00	114
L 486.02	93	M 095.00	228	M 311.02	101	M 442.02	114
L 486.03	93	M 095.01	228	M 313.01	101	M 450.01	115
L 486.04	93	M 096.00	228	M 315.01	101	M 452.01	115
L 486.05	93	M 096.01	228	M 316.01	101	M 453.01	115
L 486.06	93	M 097.00	228	M 317.01	101	M 455.01	115
L 486.07	93	M 097.01	228	M 320.02	102	M 457.01	115
L 486.09	93	M 098.00	229	M 322.02	102	M 459.01	115
L 486.11	93	M 099.00	229	M 322.04	102	M 600.00	116
L 487.00	93	M 115.01	96	M 330.01	103	M 600.01	116
L 487.01	93	M 150.01	96	M 330.02	103	M 600.02	116
L 487.05	93	M 154.01	96	M 332.01	103	M 600.03	116
L 487.06	93	M 159.01	96	M 335.01	103	M 605.00	116
L 487.07	93	M 162.01	96	M 335.02	103	M 606.00	116
L 487.08	93	M 165.01	96	M 337.01	103	M 608.01	116
L 487.09	93	M 180.01	96	M 340.01	103	M 610.00	116
L 487.10	93	M 189.01	97	M 341.01	103	M 611.00	116

Kat. No. Cat. No.	Sayfa. Page.	Kat. No. Cat. No.	Sayfa. Page.	Kat. No. Cat. No.	Sayfa. Page.	Kat. No. Cat. No.	Sayfa. Page.
M 611.01	116	M 635.02	118	M 665.01	120	M 700.01	122
M 611.02	116	M 636.00	118	M 665.02	120	M 700.02	122
M 615.01	117	M 637.00	118	M 665.03	120	M 700.03	122
M 615.02	117	M 637.01	118	M 665.04	120	M 700.04	122
M 615.03	117	M 638.00	118	M 665.05	120	M 700.05	122
M 615.04	117	M 638.01	118	M 670.01	120	M 700.07	122
M 615.05	117	M 645.01	119	M 670.02	120	M 700.08	122
M 616.01	117	M 645.02	119	M 670.03	120	M 700.09	122
M 616.02	117	M 645.03	119	M 670.04	120	M 702.03	122
M 616.03	117	M 645.04	119	M 670.05	120	M 702.04	122
M 616.04	117	M 645.05	119	M 670.06	120	M 703.03	122
M 616.05	117	M 645.06	119	M 670.07	120	M 703.04	122
M 617.01	117	M 650.04	119	M 671.01	120	M 703.05	122
M 617.02	117	M 650.05	119	M 671.02	120	M 704.03	122
M 617.03	117	M 650.06	119	M 671.03	120	M 704.04	122
M 617.04	117	M 650.07	119	M 671.04	120	M 704.05	122
M 618.01	117	M 650.08	119	M 671.05	120	M 705.01	123
M 618.02	117	M 651.04	119	M 671.06	120	M 705.02	123
M 618.03	117	M 651.05	119	M 671.07	120	M 705.03	123
M 618.04	117	M 651.06	119	M 673.01	120	M 705.04	123
M 618.05	117	M 651.07	119	M 673.02	120	M 705.05	123
M 619.01	117	M 651.08	119	M 673.03	120	M 706.01	123
M 619.02	117	M 651.09	119	M 673.04	120	M 706.02	123
M 619.03	117	M 653.04	119	M 673.05	120	M 706.03	123
M 620.01	117	M 653.05	119	M 673.06	120	M 706.04	123
M 620.02	117	M 653.06	119	M 673.07	120	M 706.05	123
M 620.03	117	M 653.07	119	M 674.01	120	M 708.01	123
M 620.04	117	M 653.08	119	M 674.02	120	M 708.02	123
M 621.01	117	M 654.04	119	M 674.03	120	M 708.03	123
M 621.02	117	M 654.05	119	M 674.04	120	M 708.04	123
M 621.03	117	M 654.06	119	M 674.05	120	M 708.05	123
M 621.04	117	M 654.07	119	M 674.06	120	M 708.06	123
M 621.05	117	M 654.08	119	M 674.07	120	M 708.07	123
M 622.01	117	M 656.04	119	M 680.01	121	M 709.01	123
M 622.02	117	M 656.05	119	M 680.02	121	M 709.02	123
M 622.03	117	M 656.06	119	M 680.03	121	M 709.03	123
M 622.04	117	M 656.07	119	M 680.04	121	M 709.04	123
M 622.05	117	M 656.08	119	M 680.05	121	M 709.05	123
M 625.01	117	M 658.04	119	M 680.06	121	M 709.06	123
M 625.02	117	M 658.05	119	M 680.07	121	M 709.07	123
M 625.03	117	M 661.01	120	M 680.08	121	M 711.03	123 / 212
M 625.04	117	M 661.02	120	M 680.09	121	M 713.01	123
M 630.01	118	M 661.03	120	M 680.10	121	M 713.02	123
M 630.02	118	M 661.04	120	M 680.11	121	M 715.01	123
M 630.03	118	M 661.05	120	M 680.12	121	M 715.02	123
M 630.04	118	M 662.01	120	M 681.02	121	M 715.03	123
M 630.05	118	M 662.02	120	M 681.04	121	M 716.01	123
M 631.01	118	M 662.03	120	M 681.06	121	M 716.02	123
M 631.02	118	M 662.04	120	M 681.08	121	M 716.03	123
M 631.03	118	M 662.05	120	M 681.09	121	M 720.05	124
M 631.04	118	M 664.01	120	M 681.10	121	M 721.04	124
M 632.01	118	M 664.02	120	M 683.03	121	M 723.04	124
M 633.01	118	M 664.03	120	M 684.02	121	M 723.05	124
M 635.00	118	M 664.04	120	M 684.04	121	M 724.04	124
M 635.01	118	M 664.05	120	M 700.00	122	M 724.05	124

Kat. No. Cat. No.	Sayfa. Page.	Kat. No. Cat. No.	Sayfa. Page.	Kat. No. Cat. No.	Sayfa. Page.	Kat. No. Cat. No.	Sayfa. Page.
M 725.01	125	M 800.01	130	N 177.01	133	N 187.03	134
M 725.02	125	M 801.00	131	N 177.02	133	N 190.01	134
M 727.01	125	M 802.01	131	N 177.03	133	N 190.02	134
M 727.02	125	M 802.02	131	N 177.04	133	N 190.03	134
M 727.03	125	M 803.00	131	N 177.05	133	N 190.04	134
M 728.01	125	M 803.02	131	N 177.06	133	N 192.01	134
M 728.02	125	M 803.03	131	N 177.07	133	N 192.02	134
M 728.03	125	M 803.10	131	N 178.01	133	N 192.03	134
M 729.01	125	M 805.01	131	N 178.02	133	N 192.04	134
M 729.02	125	M 805.02	131	N 178.03	133	N 193.01	134
M 729.03	125	M 805.03	131	N 178.04	133	N 193.02	134
M 730.01	126	M 811.01	130	N 178.05	133	N 193.03	134
M 730.02	126	M 812.01	130	N 178.06	133	N 205.01	135
M 730.03	126	M 815.01	130	N 178.07	133	N 205.02	135
M 730.06	126	M 816.01	131	N 179.01	133	N 205.03	135
M 732.01	126	M 816.03	131	N 179.02	133	N 205.04	135
M 732.02	126	M 818.01	131	N 179.03	133	N 205.05	135
M 735.01	127	M 818.02	131	N 179.04	133	N 205.06	135
M 735.02	127	M 819.02	130	N 179.05	133	N 205.07	135
M 736.01	127	M 820.02	131	N 179.06	133	N 205.08	135
M 737.01	127	M 821.02	130	N 179.07	133	N 205.09	135
M 739.01	127	M 822.02	130	N 179.08	133	N 206.01	135
M 740.02	128			N 179.09	133	N 206.02	135
M 741.02	128			N 179.10	133	N 206.03	135
M 742.02	128			N 180.01	133	N 206.04	135
M 743.02	128	N 093.00	229	N 180.02	133	N 206.05	135
M 745.00	218	N 094.00	228	N 182.01	133	N 206.06	135
M 745.01	218	N 096.00	228	N 182.02	133	N 206.07	135
M 745.02	218	N 097.00	228	N 182.03	133	N 206.08	135
M 746.00	218	N 150.00	132	N 182.04	133	N 206.09	135
M 746.01	218	N 151.00	132	N 182.05	133	N 210.01	135
M 746.02	18	N 170.00	132	N 182.06	133	N 210.02	135
M 747.00	218	N 170.01	132	N 183.01	134	N 210.03	135
M 747.01	218	N 171.00	132	N 183.02	134	N 210.04	135
M 747.02	218	N 171.01	132	N 183.03	134	N 210.05	135
M 750.00	129	N 173.00	132	N 183.04	134	N 210.06	135
M 751.00	129	N 174.00	132	N 183.05	134	N 210.07	135
M 751.01	129	N 175.01	132	N 183.06	134	N 210.08	135
M 754.01	129	N 175.02	132	N 184.01	134	N 210.09	135
M 754.02	129	N 175.03	132	N 184.02	134	N 211.01	135
M 754.03	129	N 175.04	132	N 184.03	134	N 211.02	135
M 755.00	129	N 175.05	132	N 184.04	134	N 211.03	135
M 755.01	129	N 175.06	132	N 184.05	134	N 211.04	135
M 755.02	129	N 175.07	132	N 184.06	134	N 211.05	135
M 755.03	129	N 175.08	132	N 185.01	134	N 183.02	134
M 756.01	129	N 175.09	132	N 185.02	134	N 183.03	134
M 756.02	129	N 176.01	132	N 185.03	134	N 183.04	134
M 756.03	129	N 176.02	132	N 185.04	134	N 183.05	134
M 757.01	129	N 176.03	132	N 186.01	134	N 183.06	134
M 757.02	129	N 176.04	132	N 186.02	134	N 184.01	134
M 757.03	129	N 176.05	132	N 186.03	134	N 184.02	134
M 758.01	129	N 176.06	132	N 186.04	134	N 184.03	134
M 758.02	129	N 176.07	132	N 186.05	134	N 184.04	134
M 758.03	129	N 176.08	132	N 187.01	134	N 184.05	134
M 758.04	129	N 176.09	132	N 187.02	134	N 184.06	134

Kat. No. Cat. No.	Sayfa. Page.	Kat. No. Cat. No.	Sayfa. Page.	Kat. No. Cat. No.	Sayfa. Page.	Kat. No. Cat. No.	Sayfa. Page.
N 185.01	134	N 211.06	135	N 326.01	141	P 126.00	147
N 185.02	134	N 211.07	135	N 328.01	141	P 128.00	146
N 185.03	134	N 211.08	135	N 330.01	141	P 129.00	147
N 185.04	134	N 211.09	135	N 330.02	141	P 130.01	147
N 186.01	134	N 220.00	136	N 330.03	141	P 131.01	147
N 186.02	134	N 220.01	136	N 330.04	141	P 133.01	147
N 186.03	134	N 220.02	136	N 330.05	141	P 135.00	148
N 186.04	134	N 220.03	136	N 335.01	142	P 136.00	148
N 186.05	134	N 220.04	136	N 340.01	142	P 140.01	148
N 187.01	134	N 220.05	136	N 342.01	142	P 142.00	148
N 187.02	134	N 220.06	136	N 342.02	142	P 143.00	148
N 187.03	134	N 220.07	136	N 345.01	143	P 143.01	148
N 190.01	134	N 220.08	136	N 347.01	143	P 145.00	149
N 190.02	134	N 220.10	136	N 348.01	143	P 145.01	149
N 190.03	134	N 220.11	136	N 500.06	138	P 145.02	149
N 190.04	134	N 220.12	136	N 500.07	138	P 146.00	149
N 192.01	134	N 220.13	136	N 500.08	138	P 146.01	149
N 192.02	134	N 220.14	136	N 500.09	138	P 146.02	149
N 192.03	134	N 220.15	136	N 500.10	138	P 150.00	150
N 192.04	134	N 220.16	136	N 500.11	138	P 151.00	150
N 193.01	134	N 220.17	136	N 502.06	138	P 152.00	150
N 193.02	134	N 220.18	136	N 502.07	138	P 155.00	150
N 193.03	134	N 225.00	136	N 502.08	138	P 155.01	150
N 205.01	135	N 225.01	136	N 502.09	138	P 156.01	150
N 205.02	135	N 225.02	136	N 502.10	138	P 158.01	151
N 205.03	135	N 225.03	136	N 502.11	138	P 158.03	151
N 205.04	135	N 225.04	136	N 510.06	138	P 160.00	153
N 205.05	135	N 225.05	136	N 510.08	138	P 160.01	153
N 205.06	135	N 225.06	136	N 510.10	138	P 161.00	152
N 205.07	135	N 225.07	136	N 510.12	138	P 161.01	152
N 205.08	135	N 225.08	136	N 510.14	138	P 161.02	152
N 205.09	135	N 235.00	137	N 600.00	139	P 163.00	154
N 206.01	135	N 235.01	137	N 602.00	139	P 163.01	154
N 206.02	135	N 235.02	137	N 605.00	139	P 163.02	154
N 206.03	135	N 280.01	137	N 606.00	139	P 170.01	155
N 206.04	135	N 280.02	137	N 608.00	139	P 170.02	155
N 206.05	135	N 280.03	137			P 170.03	155
N 206.06	135	N 280.04	137			P 170.04	155
N 206.07	135	N 281.02	137			P 170.05	155
N 206.08	135	N 302.00	228	P 100.00	144	P 171.00	155
N 206.09	135	N 302.01	228	P 102.00	144	P 172.01	155
N 210.01	135	N 302.03	228	P 103.00	144	P 172.02	155
N 210.02	135	N 302.04	228	P 105.00	144	P 172.03	155
N 210.03	135	N 303.01	140	P 106.00	144	P 175.01	156
N 210.04	135	N 304.01	140	P 107.01	144	P 176.01	156
N 210.05	135	N 305.00	140	P 110.00	145	P 176.02	156
N 210.06	135	N 310.01	140	P 112.00	145	P 176.03	156
N 210.07	135	N 310.02	140	P 113.00	145	P 177.00	156
N 210.08	135	N 311.01	140	P 115.00	145	P 178.00	156
N 210.09	135	N 315.01	140	P 120.00	146	P 180.00	157
N 211.01	135	N 316.01	140	P 120.01	146	P 180.01	157
N 211.02	135	N 320.01	140	P 121.00	146	P 180.02	157
N 211.03	135	N 321.01	140	P 123.00	146	P 183.00	157
N 211.04	135	N 322.01	140	P 124.00	146	P 185.00	157
N 211.05	135	N 325.01	141	P 125.00	147	P 250.00	162

Kat. No. Cat. No.	Sayfa. Page.	Kat. No. Cat. No.	Sayfa. Page.	Kat. No. Cat. No.	Sayfa. Page.	Kat. No. Cat. No.	Sayfa. Page.
P 250.01	162	P 359.02	158	P 625.00	183	R 390.08	173
P 251.00	162	P 359.03	158	P 630.00	184	R 390.09	173
P 251.01	162	P 359.04	158	P 630.01	184	R 390.10	173
P 260.01	162	P 365.00	159	P 632.00	184	R 390.11	173
P 260.02	162	P 366.00	159	P 634.00	184	R 390.12	173
P 265.00	162	P 367.00	159	P 635.00	184	R 390.13	173
P 266.00	162	P 368.00	159	P 639.00	181	R 390.14	173
P 267.00	162	P 370.00	159	P 640.00	185/ 223	R 392.01	173
P 268.00	162	P 371.00	159	P 641.00	185	R 392.02	173
P 270.00	163	P 375.01	160	P 643.00	185	R 392.03	173
P 271.00	163	P 376.01	160	P 645.00	185	R 392.06	173
P 275.00	163	P 377.01	160	P 647.00	186	R 392.07	173
P 276.00	163	P 378.01	161	P 648.00	186	R 392.08	173
P 277.00	163	P 379.01	161	P 650.00	186	R 392.11	173
P 278.00	163	P 430.00	170	P 652.00	186	R 392.12	173
P 279.00	163	P 430.01	170	P 655.00	187	R 392.13	173
P 280.00	164	P 430.02	170	P 660.00	206	R 394.01	174
P 282.00	164	P 430.03	170	P 661.00	206	R 394.02	174
P 285.00	164	P 430.04	170	P 662.00	206	R 394.06	174
P 286.00	164	P 431.00	170	P 664.00	206	R 394.07	174
P 287.00	164	P 431.01	170	P 665.00	206	R 394.11	174
P 290.00	164	P 431.02	170	P 666.00	206	R 394.12	174
P 291.00	164	P 431.03	170	P 668.00	206	R 400.01	174
P 293.00	165	P 431.04	170	P 669.00	206	R 430.00	174
P 295.00	165	P 432.00	171	P 670.00	225	R 431.00	174
P 296.00	165	P 432.01	171	P 670.01	225	R 432.00	174
P 297.00	165	P 432.02	171	P 675.00	212	R 450.00	175
P 298.00	165	P 432.03	171	P 683.00	223	R 455.00	175
P 300.00	166	P 432.04	171	P 685.00	224	R 455.01	175
P 302.00	166	P 433.01	171	P 686.00	224	R 455.04	175
P 303.00	166	P 433.02	171	P 687.00	225	R 455.06	175
P 304.01	166	P 433.04	171			R 456.01	175
P 306.01	166	P 438.03	171			R 456.02	175
P 308.01	166	P 438.04	171			R 456.03	175
P 309.01	166	P 438.05	171	R 362.00	172	R 500.01	230
P 310.01	167	P 600.00	190	R 362.01	172	R 500.02	230
P 310.02	167	P 601.00	190	R 362.02	172	R 500.03	230
P 312.00	167	P 602.00	190	R 375.00	172	R 500.05	230
P 315.01	167	P 605.00	190	R 375.01	172	R 500.06	230
P 316.01	167	P 608.00	190	R 375.02	172	R 500.07	230
P 318.01	167	P 608.02	190	R 375.03	172	R 501.01	230
P 320.01	168	P 610.00	181	R 377.00	172	R 501.02	230
P 321.01	168	P 611.00	182	R 377.01	172	R 501.03	230
P 325.01	168	P 612.00	182	R 377.02	172	R 501.04	230
P 326.01	168	P 613.00	182	R 379.00	173	R 502.01	230
P 330.00	167	P 614.00	182	R 379.01	173	R 502.02	230
P 333.01	169	P 615.00	182	R 379.02	173	R 502.03	230
P 335.01	169	P 616.00	182	R 390.00	173	R 502.05	230
P 338.02	169	P 617.00	223	R 390.01	173	R 502.06	230
P 350.00	158	P 618.01	183	R 390.02	173	R 502.07	230
P 350.01	158	P 618.02	183	R 390.03	173	R 503.01	230
P 358.01	158	P 618.03	183	R 390.04	173	R 503.02	230
P 358.02	158	P 618.05	183	R 390.05	173	R 503.03	230
P 358.03	158	P 620.00	183	R 390.06	173	R 503.04	230
P 358.04	158	P 621.00	183	R 390.07	173	R 504.01	230

Kat. No. Cat. No.	Sayfa. Page.	Kat. No. Cat. No.	Sayfa. Page.	Kat. No. Cat. No.	Sayfa. Page.	Kat. No. Cat. No.	Sayfa. Page.
R 504.02	230	S 010.00	36	T 251.01	209	T 648.00	211
R 504.03	230	S 011.00	36	T 252.01	209	T 648.01	211
R 504.04	230	S 012.00	36	T 254.01	209	T 648.02	211
R 504.05	230	S 013.00	36	T 255.01	194	T 648.03	211
R 504.06	230	S 014.00	36	T 380.00	145	T 664.01	208
R 505.01	230	S 015.00	36	T 530.00	194	T 664.05	208
R 505.02	230	S 020.00	36	T 531.00	194	T 670.00	220
R 505.03	230	S 021.00	36	T 536.00	194	T 671.01	220
R 505.04	230	S 022.00	36	T 536.01	194	T 672.00	220
R 506.01	230	S 023.00	36	T 536.02	194	T 673.00	220
R 506.02	230	S 024.00	36	T 600.00	194	T 684.02	208
R 506.03	230	S 025.00	36	T 602.00	194	T 685.00	214
R 506.04	230	S 026.00	36	T 602.05	194	T 686.03	208
R 506.05	230	S 030.00	36	T 603.00	194	T 688.00	215
R 506.06	230	S 500.00	176	T 603.02	194	T 688.01	215
R 507.01	230	S 500.02	176	T 603.05	194	T 688.03	215
R 507.02	230	S 500.03	176	T 603.06	194	T 688.05	215
R 507.03	230	S 500.04	176	T 605.00	188	T 689.00	215
R 507.04	230	S 502.01	176	T 607.00	195	T 689.01	215
R 508.01	230	S 502.03	176	T 607.03	195	T 689.02	215
R 508.02	230	S 505.01	176	T 607.04	195	T 690.00	215
R 508.03	230	S 505.03	176	T 607.06	195	T 691.00	215
R 508.04	230	S 505.10	176	T 607.10	195	T 691.01	215
R 508.05	230	S 510.00	176	T 608.00	195	T 691.02	215
R 508.06	230	S 550.00	177	T 608.05	195	T 691.03	215
R 509.01	230	S 550.01	177	T 608.07	195	T 691.04	215
R 509.02	230	S 551.00	177	T 608.10	195	T 691.05	213
R 509.03	230	S 552.00	178	T 609.00	195	T 691.06	213
R 509.04	230	S 552.01	178	T 609.05	195	T 691.07	213
R 510.01	230	S 552.02	178	T 609.06	195	T 691.08	213
R 511.01	230	S 552.03	178	T 609.07	195	T 692.00	213
R 512.01	230	S 552.04	178	T 609.08	195	T 693.00	213
R 513.01	230	S 552.05	178	T 609.10	195	T 694.00	213
R 514.01	230	S 552.06	178	T 609.12	195	T 694.01	213
R 515.01	230	S 552.08	178	T 610.00	200	T 694.02	213
R 516.01	230	S 552.10	178	T 611.00	200	T 695.00	213
R 518.01	231	S 552.12	178	T 615.00	200	T 695.01	213
R 518.02	231	S 554.00	178	T 616.00	200	T 695.02	213
R 519.01	231	S 554.01	178	T 620.00	201	T 700.00	216
R 519.02	231	S 554.02	178	T 621.00	201	T 700.02	216
R 520.01	231	S 555.00	178	T 622.00	201	T 700.03	216
R 520.02	231	S 555.01	178	T 622.01	201	T 700.04	216
R 521.01	231	S 556.01	177	T 623.00	201	T 700.06	216
R 521.02	231	S 556.03	177	T 623.01	201	T 700.07	216
R 522.01	231	S 557.00	177	T 625.00	201	T 700.08	216
R 522.02	231	S 557.01	177	T 627.00	201	T 701.00	216
R 523.01	231	S 557.02	177	T 628.01	208	T 702.00	216
R 523.02	231	S 557.03	177	T 628.04	208	T 703.00	216
R 525.01	231	S 558.00	178/ 213	T 635.01	208	T 705.00	216
R 526.01	231	S 560.01	177	T 640.00	211	T 710.00	217
R 780.00	219	S 560.03	177	T 641.00	211	T 711.00	217
		S 560.05	177	T 643.00	211	T 712.00	217
		S 560.07	177	T 644.01	211	T 714.00	217
		S 560.08	177	T 645.01	211	T 720.00	218
				T 647.00	211	T 721.00	218

Kat. No. Cat. No.	Sayfa. Page.	Kat. No. Cat. No.	Sayfa. Page.	Kat. No. Cat. No.	Sayfa. Page.	Kat. No. Cat. No.	Sayfa. Page.
T 725.00	219	V 610.00	197	V 636.00	199	V 704.02	212
T 726.00	219	V 610.01	197	V 643.00	199	V 704.03	221
T 726.01	219	V 610.02	197	V 643.02	199	V 704.04	221
T 726.02	219	V 610.03	197	V 644.00	90	V 704.05	221
T 728.02	214	V 610.04	197	V 645.01	200	V 704.06	221
T 729.00	214	V 610.05	197	V 645.02	200	V 705.00	212
T 745.00	222	V 610.06	197	V 645.03	200	V 705.01	212
T 746.00	222	V 610.07	197	V 645.04	200	V 705.02	212
T 747.00	222	V 610.08	197	V 648.00	200	V 705.03	221
T 749.00	222	V 610.12	197	V 648.03	200	V 705.04	221
T 750.00	226	V 610.14	197	V 649.00	200	V 705.05	221
T 750.01	226	V 610.16	197	V 649.03	200	V 705.06	221
T 752.00	226	V 610.18	197	V 650.00	202	V 705.07	221
T 760.00	224	V 610.19	197	V 651.00	202	V 705.08	221
T 760.01	224	V 612.00	197	V 652.00	202	V 706.00	212
T 760.02	224	V 615.00	197	V 655.00	202	V 706.01	212
T 760.03	224	V 617.01	197	V 655.01	202	V 706.02	212
T 761.00	224	V 620.00	198	V 655.02	202	V 707.00	212
T 761.01	224	V 620.01	198	V 655.03	202	V 707.01	212
T 761.02	224	V 620.02	198	V 657.00	202	V 707.02	212
T 765.00	224	V 620.03	198	V 657.01	202	V 710.00	212
T 766.00	224	V 620.04	198	V 657.02	202	V 710.01	212
T 766.01	224	V 620.05	198	V 657.03	202	V 711.00	212
T 792.00	178	V 621.00	198	V 657.05	202	V 712.00	212
T 792.01	178	V 621.01	198	V 657.06	202	V 712.10	212
T 792.02	178	V 621.02	198	V 658.01	209	V 713.00	212
T 795.00	217	V 621.03	198	V 659.00	209	V 720.00	214
T 890.00	227	V 622.00	198	V 660.00	203	V 720.01	214
T 891.00	227	V 622.01	198	V 661.00	203	V 721.00	214
		V 623.00	198	V 661.01	203	V 725.06	214
		V 623.01	198	V 662.00	203	V 725.07	214
		V 624.00	198	V 662.01	203	V 725.08	214
V 505.00	196	V 624.01	198	V 662.05	203	V 725.09	214
V 505.01	196	V 624.02	198	V 662.06	203	V 725.10	214
V 505.03	196	V 624.03	198	V 663.00	203	V 725.11	214
V 505.04	196	V 624.04	198	V 664.01	208	V 725.12	214
V 554.01	196	V 624.05	198	V 664.05	208	V 725.13	214
V 557.01	196	V 625.00	198	V 665.00	203	V 725.14	214
V 561.01	210	V 625.01	198	V 665.01	203	V 725.15	214
V 562.01	210	V 625.02	198	V 666.00	203	V 725.16	214
V 564.01	210	V 625.03	198	V 667.00	203	V 727.06	214
V 565.01	210	V 626.00	198	V 667.01	203	V 727.07	214
V 565.05	210	V 626.01	198	V 667.02	203	V 727.08	214
V 599.00	191	V 627.00	198	V 668.00	203	V 727.09	214
V 600.00	191	V 627.01	198	V 669.00	203	V 727.10	214
V 601.00	191	V 628.01	208	V 679.00	202	V 727.11	214
V 603.00	191	V 628.04	208	V 679.03	202	V 727.12	214
V 603.01	191	V 630.00	199	V 684.02	208	V 727.13	214
V 605.00	196	V 630.01	199	V 686.03	208	V 727.14	214
V 606.00	196 / 197	V 631.00	199	V 697.01	208	V 727.15	214
V 608.00	196 / 197	V 632.00	199	V 698.01	208	V 727.16	214
V 609.00	196	V 633.00	199	V 699.01	208	V 728.02	214
V 609.04	196	V 633.01	199	V 703.01	208	V 728.03	214
V 609.12	196	V 635.00	199	V 704.00	212	V 728.04	214
		V 635.01	208	V 704.01	212	V 728.05	214

Kat. No. Cat. No.	Sayfa. Page.	Kat. No. Cat. No.	Sayfa. Page.	Kat. No. Cat. No.	Sayfa. Page.	Kat. No. Cat. No.	Sayfa. Page.
V 728.06	214	Y 103.05	242	Y 122.13	241	Y 143.15	241
V 728.07	214	Y 103.06	242	Y 122.15	241	Y 143.20	241
V 728.08	214	Y 105.10	242	Y 122.20	241	Y 143.26	241
V 728.09	214	Y 105.13	242	Y 122.26	241	Y 145.15	260
V 735.00	219	Y 105.15	242 / 260	Y 123.10	241	Y 150.10	240
V 736.00	219	Y 105.20	242	Y 123.13	241	Y 150.13	240
V 737.00	219	Y 105.26	242	Y 123.15	241	Y 150.15	240
V 750.00	223	Y 105.62	253	Y 123.20	241	Y 150.20	240
V 752.00	223	Y 105.68	253	Y 123.26	241	Y 150.26	240
V 754.00	223	Y 106.10	242	Y 125.15	260	Y 150.62	252
V 754.04	223	Y 106.13	242	Y 130.10	240	Y 150.68	252
V 754.05	223	Y 106.15	242	Y 130.13	240	Y 151.10	240
V 754.06	223	Y 106.20	242	Y 130.15	240	Y 151.13	240
V 760.00	225	Y 106.26	242	Y 130.20	240	Y 151.15	240
V 760.01	225	Y 106.62	253	Y 130.26	240	Y 151.20	240
V 760.02	225	Y 106.68	253	Y 130.62	252	Y 151.26	240
V 760.05	225	Y 110.10	240	Y 130.68	252	Y 151.62	252
V 760.10	225	Y 110.15	240	Y 131.10	240	Y 151.68	252
V 765.00	225	Y 110.20	240	Y 131.13	240	Y 152.10	241
V 766.00	225	Y 110.26	240	Y 131.15	240	Y 152.13	41
		Y 110.62	252	Y 131.20	240	Y 152.15	241
		Y 110.68	252	Y 131.26	240	Y 152.20	241
		Y 111.10	240	Y 131.62	252	Y 152.26	241
Y 095.01	257 / 258	Y 111.13	240	Y 131.68	252	Y 153.10	241
Y 095.02	258	Y 111.15	240	Y 132.10	241	Y 153.13	241
Y 095.03	258	Y 111.20	240	Y 132.13	241	Y 153.15	241
Y 095.04	251 / 255	Y 111.26	240	Y 132.15	241	Y 153.20	241
Y 095.05	251 / 255	Y 111.62	252	Y 132.20	241	Y 153.26	241
Y 095.06	251	Y 111.68	252	Y 132.26	241	Y 155.15	260
Y 095.07	243 / 251	Y 112.10	241	Y 133.10	241	Y 160.10	240
Y 095.08	243 / 247	Y 112.13	241	Y 133.13	241	Y 160.13	240
Y 095.09	243	Y 112.15	241	Y 133.15	241	Y 160.15	240
Y 095.10	243	Y 112.20	241	Y 133.20	241	Y 160.20	240
Y 100.01	242	Y 112.26	241	Y 133.26	241	Y 160.26	240
Y 100.02	242	Y 113.10	241	Y 135.15	260	Y 160.62	252
Y 100.03	242	Y 113.13	241	Y 140.10	240	Y 160.68	252
Y 100.04	242	Y 113.15	241	Y 140.13	240	Y 161.10	240
Y 100.05	242	Y 113.20	241	Y 140.15	240	Y 161.13	240
Y 100.06	242	Y 113.26	241	Y 140.20	240	Y 161.15	240
Y 100.51	253	Y 115.15	260	Y 140.26	240	Y 161.20	240
Y 100.52	253	Y 120.10	240	Y 140.62	252	Y 161.26	240
Y 100.53	253	Y 120.13	240	Y 140.68	252	Y 161.62	252
Y 100.54	253	Y 120.15	240	Y 141.10	240	Y 161.68	252
Y 100.55	253	Y 120.20	240	Y 141.13	240	Y 162.10	241
Y 100.56	253	Y 120.26	240	Y 141.15	240	Y 162.13	241
Y 102.01	261	Y 120.62	252	Y 141.26	240	Y 162.15	241
Y 102.02	261	Y 120.68	252	Y 141.62	252	Y 162.20	241
Y 102.03	261	Y 121.10	240	Y 141.68	252	Y 162.26	241
Y 102.04	261	Y 121.13	240	Y 142.10	241	Y 163.10	241
Y 102.05	261	Y 121.15	240	Y 142.13	241	Y 163.13	241
Y 102.06	261	Y 121.20	240	Y 142.15	241	Y 163.15	241
Y 103.01	242	Y 121.26	240	Y 142.20	241	Y 163.20	241
Y 103.02	242	Y 121.62	252	Y 142.26	241	Y 163.26	241
Y 103.03	242	Y 121.68	252	Y 143.10	241	Y 165.15	260
Y 103.04	242	Y 122.10	241	Y 143.13	241	Y 190.03	243

Kat. No. Cat. No.	Sayfa. Page.	Kat. No. Cat. No.	Sayfa. Page.	Kat. No. Cat. No.	Sayfa. Page.	Kat. No. Cat. No.	Sayfa. Page.
Y 190.05	243	Y 230.15	244	Y 300.04	250	Y 313.20	249
Y 190.07	243	Y 231.10	244	Y 300.05	250	Y 313.26	249
Y 190.10	243	Y 231.13	244	Y 300.06	250	Y 315.10	260
Y 190.55	252	Y 231.15	244	Y 302.01	261	Y 315.15	260
Y 191.03	243	Y 232.10	245	Y 302.02	261	Y 320.05	254
Y 191.05	243	Y 232.13	245	Y 302.03	261	Y 320.08	254
Y 191.07	243	Y 232.15	245	Y 302.04	261	Y 320.10	248
Y 191.10	243	Y 233.10	245	Y 302.05	261	Y 320.13	248
Y 191.60	252	Y 233.13	245	Y 302.06	261	Y 320.15	248
Y 193.00	243	Y 233.15	245	Y 303.01	250	Y 320.20	248
Y 195.00	243	Y 240.10	244	Y 303.02	250	Y 320.26	248
Y 200.01	246	Y 240.13	244	Y 303.03	250	Y 321.08	254
Y 200.02	246	Y 240.15	244	Y 303.04	250	Y 321.10	248
Y 200.03	246	Y 241.10	244	Y 303.05	250	Y 321.13	248
Y 200.04	246	Y 241.13	244	Y 303.06	250	Y 321.15	248
Y 200.05	246	Y 241.15	244	Y 304.01	255	Y 321.20	248
Y 200.06	246	Y 242.10	245	Y 304.02	255	Y 321.26	248
Y 203.01	246	Y 242.13	245	Y 304.03	255	Y 322.10	249
Y 203.02	246	Y 242.15	245	Y 304.04	255	Y 322.13	249
Y 203.03	246	Y 243.10	245	Y 304.05	255	Y 322.15	249
Y 203.04	246	Y 243.13	245	Y 304.06	255	Y 322.20	249
Y 203.05	246	Y 243.15	245	Y 305.05	255	Y 322.26	249
Y 203.06	246	Y 250.10	244	Y 305.08	255	Y 323.10	249
Y 205.10	246	Y 250.13	244	Y 305.10	250 / 260	Y 323.13	249
Y 205.13	246	Y 250.15	244	Y 305.13	250	Y 323.15	249
Y 205.15	246	Y 251.10	244	Y 305.15	250 / 260	Y 323.20	249
Y 206.10	246	Y 251.13	244	Y 305.20	250	Y 323.26	249
Y 206.13	246	Y 251.15	244	Y 305.26	250	Y 325.10	260
Y 206.15	246	Y 252.10	245	Y 306.08	255	Y 325.15	260
Y 210.10	244	Y 252.13	245	Y 306.11	250	Y 330.05	254
Y 210.13	244	Y 252.15	245	Y 306.13	250	Y 330.08	254
Y 210.15	244	Y 253.10	245	Y 306.15	250	Y 330.10	248
Y 211.10	244	Y 253.13	245	Y 306.20	250	Y 330.13	248
Y 211.13	244	Y 253.15	245	Y 306.26	250	Y 330.15	248
Y 211.15	244	Y 260.10	244	Y 310.05	254	Y 330.20	248
Y 212.10	245	Y 260.13	244	Y 310.08	254	Y 330.26	248
Y 212.13	245	Y 260.15	244	Y 310.10	248	Y 331.08	254
Y 212.15	245	Y 261.10	244	Y 310.13	248	Y 331.10	248
Y 213.10	245	Y 261.13	244	Y 310.15	248	Y 331.13	248
Y 213.13	245	Y 261.15	244	Y 310.20	248	Y 331.15	248
Y 213.15	245	Y 262.10	245	Y 310.26	248	Y 331.20	248
Y 220.10	244	Y 262.13	245	Y 311.08	254	Y 331.26	248
Y 220.13	244	Y 262.15	245	Y 311.10	248	Y 332.10	249
Y 220.15	244	Y 263.10	245	Y 311.13	248	Y 332.13	249
Y 221.10	244	Y 263.13	245	Y 311.15	248	Y 332.15	249
Y 221.13	244	Y 263.15	245	Y 311.20	248	Y 332.20	249
Y 221.15	244	Y 290.03	247	Y 311.26	248	Y 332.26	249
Y 222.10	245	Y 290.05	247	Y 312.10	249	Y 333.10	249
Y 222.13	245	Y 290.07	247	Y 312.13	249	Y 333.13	249
Y 222.15	245	Y 290.10	247	Y 312.15	249	Y 333.15	249
Y 223.10	245	Y 293.03	247	Y 312.20	249	Y 333.20	249
Y 223.13	245	Y 295.00	247	Y 312.26	249	Y 333.26	249
Y 223.15	245	Y 300.01	250	Y 313.10	249	Y 335.10	260
Y 230.10	244	Y 300.02	250	Y 313.13	249	Y 335.15	260
Y 230.13	244	Y 300.03	250	Y 313.15	249	Y 340.05	254

Kat. No. Cat. No.	Sayfa. Page.	Kat. No. Cat. No.	Sayfa. Page.	Kat. No. Cat. No.	Sayfa. Page.	Kat. No. Cat. No.	Sayfa. Page.
Y 340.08	254	Y 360.26	248	Y 440.04	256	Y 820.04	264
Y 340.10	248	Y 361.08	254	Y 440.07	256	Y 820.05	264
Y 340.13	248	Y 361.10	248	Y 440.10	256	Y 820.06	264
Y 340.15	248	Y 361.13	248	Y 441.04	256	Y 829.00	264
Y 340.20	248	Y 361.15	248	Y 441.07	256	Y 830.00	265
Y 340.26	248	Y 361.20	248	Y 441.10	256	Y 830.01	265
Y 341.08	254	Y 361.26	248	Y 450.04	256	Y 831.05	265
Y 341.10	248	Y 362.10	249	Y 450.07	256	Y 831.13	265
Y 341.13	248	Y 362.13	249	Y 450.10	256	Y 831.22	265
Y 341.15	248	Y 362.15	249	Y 451.04	256	Y 831.46	265
Y 341.20	248	Y 362.20	249	Y 451.07	256	Y 840.00	265
Y 341.26	248	Y 362.26	249	Y 451.10	256	Y 841.00	265
Y 342.10	249	Y 363.10	249	Y 460.04	256	Y 841.01	265
Y 342.13	249	Y 363.13	249	Y 460.07	256	Y 842.00	265
Y 342.15	249	Y 363.15	249	Y 460.10	256	Y 842.01	265
Y 342.20	249	Y 363.20	249	Y 461.04	256	Y 845.00	265
Y 342.26	249	Y 363.26	249	Y 461.07	256	Y 847.00	265
Y 343.10	249	Y 365.10	260	Y 461.10	256	Y 849.00	265
Y 343.13	249	Y 365.15	260	Y 495.00	257	Y 849.01	265
Y 343.15	249	Y 390.03	251 / 255	Y 500.01	258	Y 849.20	265
Y 343.20	249	Y 390.05	251 / 255	Y 500.02	258	Y 849.21	265
Y 343.26	249	Y 390.07	251	Y 506.04	258	Y 849.22	265
Y 345.10	260	Y 390.10	251	Y 506.06	258	Y 849.23	265
Y 345.15	260	Y 393.00	251 / 255	Y 506.13	258	Y 849.24	265
Y 350.05	254	Y 395.00	251 / 255	Y 510.04	258	Y 850.00	257 / 264
Y 350.08	254	Y 400.01	257	Y 510.06	258	Y 851.00	255 / 264
Y 350.10	248	Y 400.02	257	Y 510.13	258	Y 852.00	264
Y 350.13	248	Y 400.03	257	Y 595.00	258	Y 852.10	264
Y 350.15	248	Y 400.04	257	Y 600.01	259	Y 852.20	264
Y 350.20	248	Y 400.05	257	Y 600.02	259	Y 852.30	264
Y 350.26	248	Y 400.06	257	Y 610.06	259	Y 880.00	263
Y 351.08	254	Y 405.04	257	Y 612.07	259	Y 880.01	263
Y 351.10	248	Y 405.07	257	Y 620.06	259	Y 880.02	263
Y 351.13	248	Y 405.10	257	Y 622.07	259	Y 880.03	263
Y 351.15	248	Y 406.04	257	Y 630.06	259	Y 880.04	263
Y 351.20	248	Y 406.07	257	Y 632.07	259	Y 882.00	262
Y 351.26	248	Y 406.10	257	Y 640.06	259	Y 890.00	266
Y 352.10	249	Y 410.04	256	Y 642.07	259	Y 891.00	266
Y 352.13	249	Y 410.07	256	Y 650.06	259		
Y 352.15	249	Y 410.10	256	Y 652.07	259		
Y 352.20	249	Y 411.04	256	Y 660.06	259		
Y 352.26	249	Y 411.07	256	Y 662.07	259	Z 001.00	237
Y 353.10	249	Y 411.10	256	Y 800.00	264	Z 002.00	237
Y 353.13	249	Y 420.04	256	Y 800.01	264	Z 003.00	237
Y 353.15	249	Y 420.07	256	Y 801.00	264	Z 004.00	237
Y 353.20	249	Y 420.10	256	Y 802.00	264	Z 005.00	237
Y 353.26	249	Y 421.04	256	Y 802.01	264	Z 006.00	237
Y 355.10	260	Y 421.07	256	Y 809.00	264	Z 009.00	237
Y 355.15	260	Y 421.10	256	Y 809.01	264	Z 010.00	237
Y 360.05	254	Y 430.04	256	Y 810.00	264	Z 012.00	237
Y 360.08	254	Y 430.07	256	Y 812.00	264	Z 015.00	237
Y 360.10	248	Y 430.10	256	Y 819.00	264	Z 015.01	237
Y 360.13	248	Y 431.04	256	Y 820.01	264	Z 015.02	237
Y 360.15	248	Y 431.07	256	Y 820.02	264	Z 016.00	237
Y 360.20	248	Y 431.10	256	Y 820.03	264	Z 016.01	237

Kat. No. Cat. No.	Sayfa. Page.
Z 016.02	237
Z 060.00	237
Z 065.00	237
Z 095.00	237
Z 096.00	237
Z 097.00	237
Z 100.00	234
Z 120.00	234
Z 121.00	234
Z 150.00	234
Z 150.01	234
Z 150.03	234
Z 151.01	234
Z 151.03	234
Z 160.08	235
Z 160.09	235
Z 160.10	235
Z 160.11	235
Z 160.12	235
Z 160.13	235
Z 160.14	235
Z 160.15	235
Z 160.16	235
Z 160.17	235
Z 160.18	235
Z 160.19	235
Z 160.20	235
Z 160.21	235
Z 160.22	235
Z 160.23	235
Z 170.01	235
Z 170.04	235
Z 170.07	235
Z 171.01	235
Z 172.01	235
Z 180.00	234
Z 180.01	234
Z 180.02	234
Z 188.00	236
Z 190.00	236



BAHADIR TIBBİ ALETLER SANAYİ VE TİCARET A.Ş.
BAHADIR MEDICAL EQUIPMENT INDUSTRY AND TRADE CO.

Organize Sanayi 55300 / Kutlukent / SAMSUN / TURKEY
Tel : +90 (362) 266 70 00 (PBX) Fax : +90 (362) 266 70 05
Url: www.bahadir.com.tr E-mail: info@bahadir.com.tr