



 BAHADIR®

KBB, PLASTİK VE REKONSTRÜKTİF CERRAHI
ENT, PLASTIC AND RECONSTRUCTIVE SURGERY



KBB, Plastik ve Rekonstrüktif Cerrahi
ENT, Plastic and Reconstructive Surgery

BAHADIR A.Ş.
Organize Sanayi Bölgesi
55300 SAMSUN
Location 41.2389, 36.4277
Tel: 0362 266 70 00
Fax: 0362 266 70 05

www.bahadir.com.tr
info@bahadir.com.tr





BAHADIR; sađlık sektöründe hizmet veren tecrübeli bir aile şirkettir. 1983 yılında kurulmuş olan firma Türkiye'nin önde gelen cerrahi alet üreticilerinden birisidir. Ana üretim alanlarımız; sađlık kurumlarının bütün branşları için medikal aletler, steril konteyner sistemleri, hastane terlikleri ve masa üstü buhar sterilizatördür. Diğer ürünler için üretim ve geliştirme çalışmaları yapılmaktadır. Ürünlerin büyük bir bölümü ihraç edilmektedir. BAHADIR; geçmişin tecrübesini, ileri teknolojilerle birleştirerek, yüksek kalite ve servis hizmeti sağlamak konusunda daima önde olma çabası içerisindedir. Misyonumuz; bilgi ve tecrübeyi, çok çalışma ve azimle birleştirerek; sürekli gelişen dünyada lider ve kalıcı olabilmektir. Bizi ne zaman isterseniz ziyaret edebilirsiniz. Sizleri aramızda görmekten memnuniyet duyarız.

BAHADIR is an experienced family company serving in healthcare sector. It is one of the leading manufacturer of surgical instruments in Turkey established in 1983. Our main production fields are medical instruments for all branches in hospitals and schools of medicine, sterile container systems, hospital clogs and banch top steam sterilizers. The production and development studies for other products are carried out. A great number of our products are exported. BAHADIR strives to be at the forefront by adding past experiences to those of advancing technologies and provide high quality product and service. Our mission is to combine knowledge and experience with hardwork and enthusiasm for be coming permanent and leader in ever-evolving world. You can visit us whenever you want. We would be happy to see you among us.





BAHADIR; cerrahi aletlerin dövme malzemelerini, temsilcisi olduđu firmalardan almaktadır. Müşterilerden gelen siparişler doğrultusunda bu malzemeler firmamızda işlenerek nihayi ürün haline getirilir.

The raw forged materials of the medical instruments are bought from the companies whose representative is BAHADIR. Raw materials are converted into a final product after being processed in our company according to the orders from our customers.





Bütün branşlar için üretilen cerrahi alet ve aparatlar, klasik ve modern cerrahi tekniklerine uygun olarak üretilmektedir. Yüksek kalite için Alman paslanmaz çelik ham malzeme kullanılmaktadır.

The surgical instruments and apparatus are produced in accordance with the classical and modern surgical techniques for all branches. German stainless steel raw material is used for high quality.





Klasik cerrahi alet başlığı altında bulunan ürünlerimiz, tüm cerrahi branşlarda, ihtiyaçları karşılayabilecek çeşitliliğe sahiptir. Tesislerimizde; genel cerrahi, ortopedi cerrahi, beyin cerrahi, KBB, kalp ve damar cerrahi, üroloji, mikro cerrahi, jinekoloji ve plastik cerrahi branşları için aletler üretilmektedir.



Our products under the title of classical surgery are rich enough to meet the needs of the surgical branches in schools of medicine and hospitals. Medical Instruments for general surgery, orthopedic surgery, brain surgery, ENT, cardio-vascular surgery, urology, micro surgery, gynaecology, plastic and reconstructive surgery are produced in our facilities



BAHADIR markası ile tedarik edilen ürünler, işçilik ve malzeme hatalarına karşı garantilidir. Garanti periyodu içerisinde hatalı malzemeler yenileri ile değiştirilir.

The products supplied under BAHADIR brand are guaranteed for the defects stemming from workmanship and material. Within the guarantee period, the defected material is replaced with a new one.



Katalogdaki resimler, ölçüler ve detaylar bilgi verilmeksizin değiştirilebilir.

Katalogumuzda bulduğunuz yanlışlıkları, eksiklikleri ve katalog hakkındaki önerilerinizi bildirmenizi önemle rica ederiz.

Her hakkı saklıdır. Bu katalogun hiçbir bölümü BAHADIR'ın yazılı izni olmadan kopya edilemez, yayınlanamaz.

We, may change pictures, dimensions and details in this catalog without. Without informing third parties.

We kindly ask you to inform us about mistakes, lack of information you may find in this catalog and your comments please.

All rights reserved. No part of this catalog may be reproduced in any form without written permission from BAHADIR.



Genel Cerrahi
General Surgery

1-84



Otoloji - Kulak Mikrocerrahi
Otology - Ear Microsurgery

85-120



Rinoloji - Rinoplasti
Rhinology - Rhinoplasty

121-148



Sinüs ve Hipofizektomi
Sinus and Hypophysectomy

149 - 158



Oral Cerrahi, Adenoidektomi - Tonsilektomi
Larengoloji - Bronkoskopi, Özofagoskopi - Trakeotomi
Oral Surgery, Adenoidectomy - Tonsillectomy
Laryngology - Bronchoscopy, Oesophagoscopy - Tracheotomy

159-194



Oral, Yüz Cerrahi
Oral, Facial Surgery

195-212



Genel Cerrahi
General Surgery

213-226



Setler
Sets

227-258



Sayısal İndeks
Numerical Index

259-271

0-9



Genel Cerrahi
General Surgery



A 500.00 - A 500.04

A 500.00 10 cm

A 500.01 15 cm

A 500.02 20 cm

A 500.03 30 cm

A 500.04 50 cm



1/2

A 518.00
Ölçme 150 mm
Measuring 150 mm



1/1

CASTROVIEJO
A 516.00
Ölçme 15 mm
Measuring 15 mm



1/1

CASTROVIEJO
A 516.01
Ölçme 20 mm
Measuring 20 mm

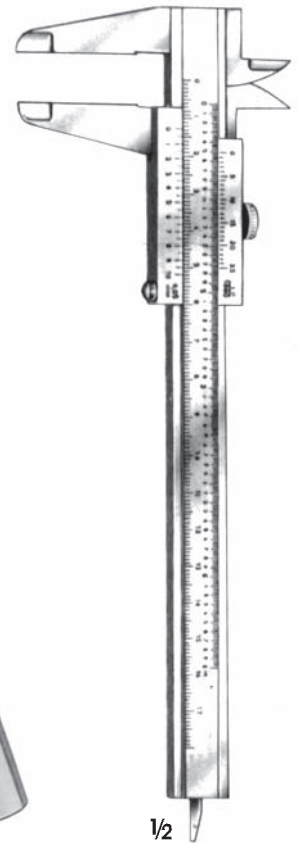

1/2

A 510.00
Ölçme 150 mm
Measuring 150 mm

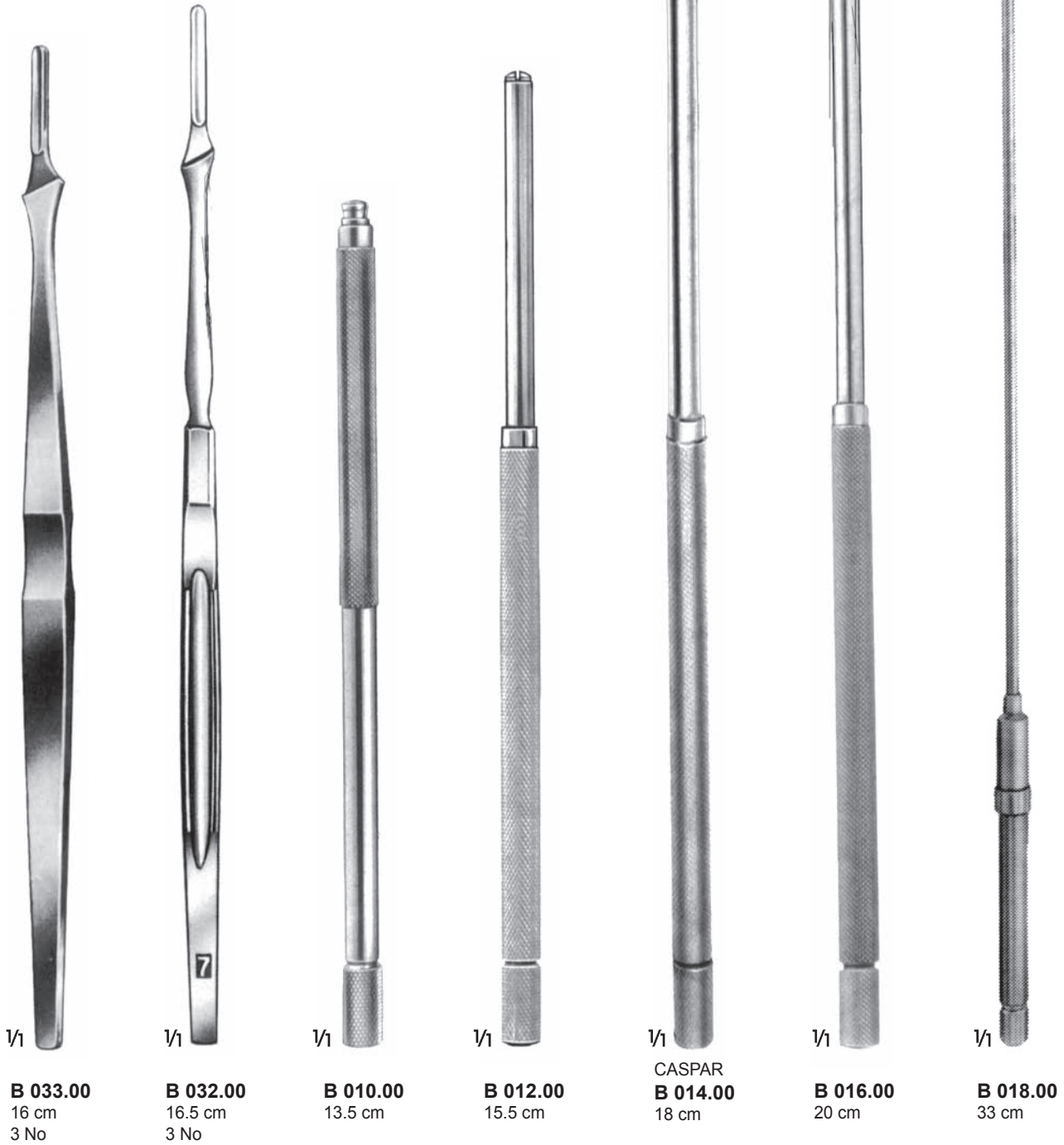



3 No



$\frac{1}{1}$
B 030.00
13.5 cm



$\frac{1}{1}$
B 030.01
13.5 cm



$\frac{1}{1}$
B 030.02
21.5 cm



$\frac{1}{1}$
B 034.00
22.5 cm



$\frac{1}{1}$
B 034.01
22.5 cm



4 No

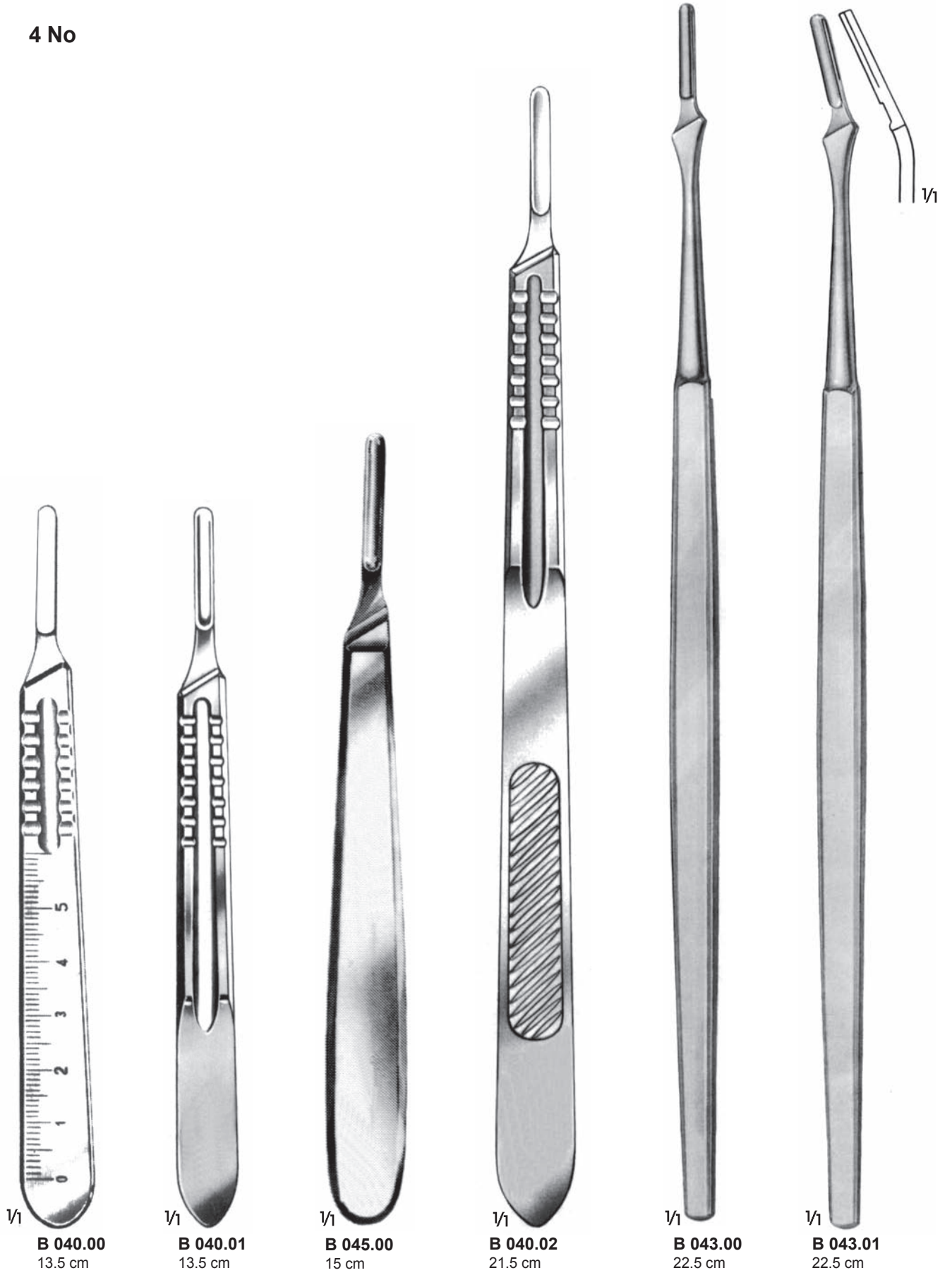

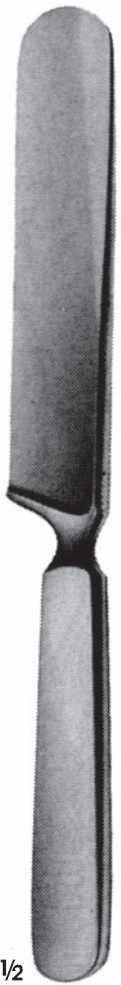

1/2
REHN
B 180.00
23.5 cm

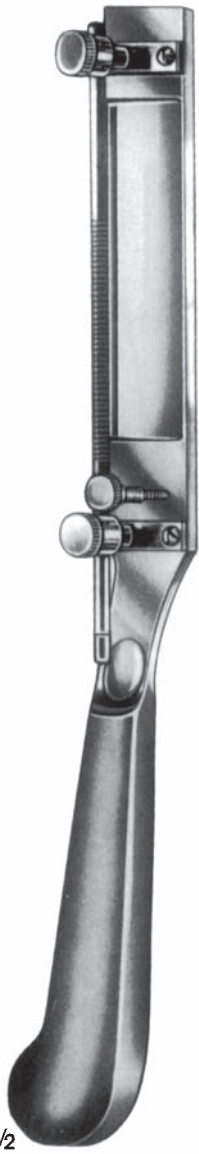

1/2
SCHINIC
B 182.00
30 cm

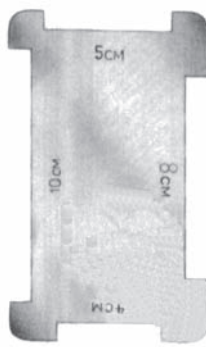

B 188.00

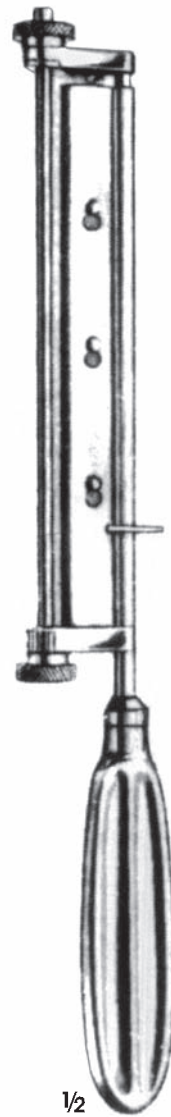

1/2
WATSON
B 184.00
30 cm



1/2
SILVER
B 186.00
19 cm





C 102.00
Düz/Straight
12 cm



C 103.00
Eğri/Curved
12 cm



C 112.00 - C 113.00
16 cm



C 112.00
Düz/Straight



C 113.00
Eğri/Curved



C 116.00 Düz/Straight
C 117.00 Eğri/Curved
16 cm

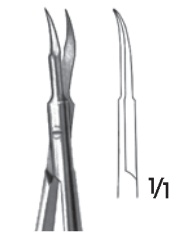

C 117.00



C 120.00 - C 121.00
Çift ağız tırtıllı/Both jaws serrated
16 cm



C 120.00
Düz/Straight



C 121.00
Eğri/Curved

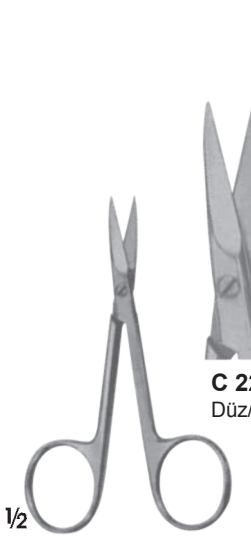

C 220.00 - C 221.00
9 cm



C 220.00
Düz/Straight



C 221.00
Eğri/Curved

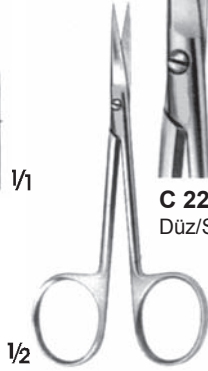

C 222.00 - C 223.00
9.5 cm



C 222.00
Düz/Straight



C 223.00
Eğri/Curved



C 224.00
Düz/Straight
Sivri/Sharp
11.5 cm



1/1



C 230.00 - C 233.00
11 cm



C 230.00
Düz/Straight
Sivri/Sharp



C 231.00
Eğri/Curved
Sivri/Sharp



C 232.00
Sivri/Sharp
Künt/Blunt



C 233.00
Sivri/Sharp
Künt/Blunt

1/1

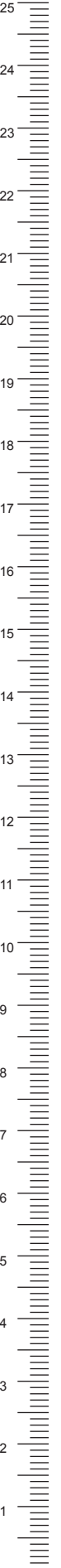



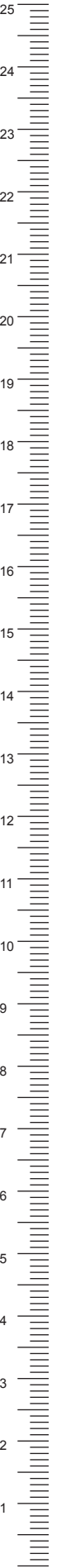

1/2
CHADWICK
C 260.00
11.5 cm

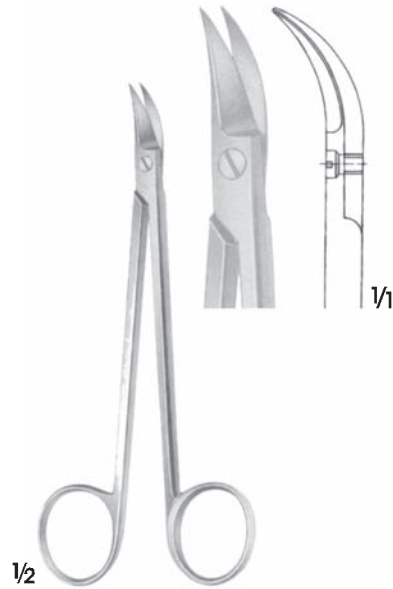

1/2
QUINBY
C 261.00
13 cm

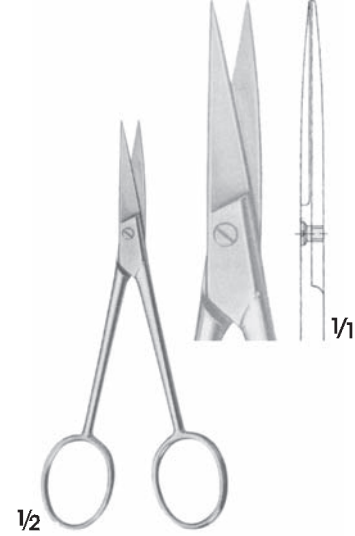

1/2
C 264.00
11 cm

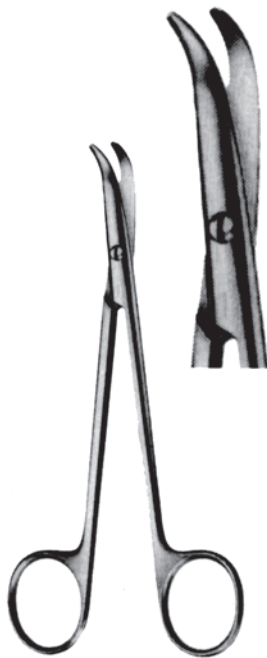

FOMON
C 265.00 - C 266.00

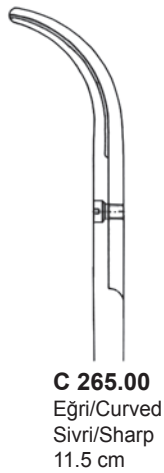

C 265.00
Eğri/Curved
Sivri/Sharp
11.5 cm

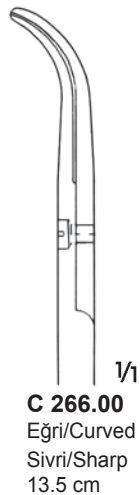

C 266.00
Eğri/Curved
Sivri/Sharp
13.5 cm



1/2
LANDOLT
C 268.00 - C 269.00
12 cm



C 268.00

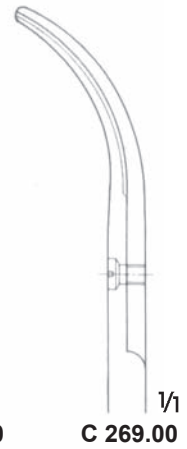

C 269.00



C 310.01 - C 310.04
Sivri/Künt, Düz
Sharp/Blunt, Straight



C 310.01
11.5 cm



C 310.02
13 cm



C 310.03
14.5 cm

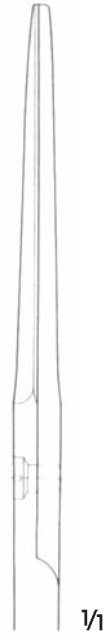

C 310.04
15 cm



C 312.02 - C 312.05
Künt/Blunt
Düz/ Straight



C 312.02
13 cm



C 312.03
14.5 cm



C 312.04
15 cm

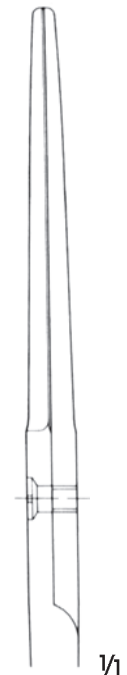

C 312.05
16.5 cm



C 311.01 - C 311.05
Sivri/Künt, Eğri
Sharp/Blunt, Curved



C 311.01
11.5 cm



C 311.02
13 cm



C 311.03
14.5 cm



C 311.04
15 cm



C 311.05
16.5 cm



COOPER
C 313.01 - C 313.05
Künt/Blunt
Eğri/Curved



C 313.01
11.5 cm



C 313.02
13 cm



C 313.03
14.5 cm



C 313.04
15 cm



C 313.05
16.5 cm

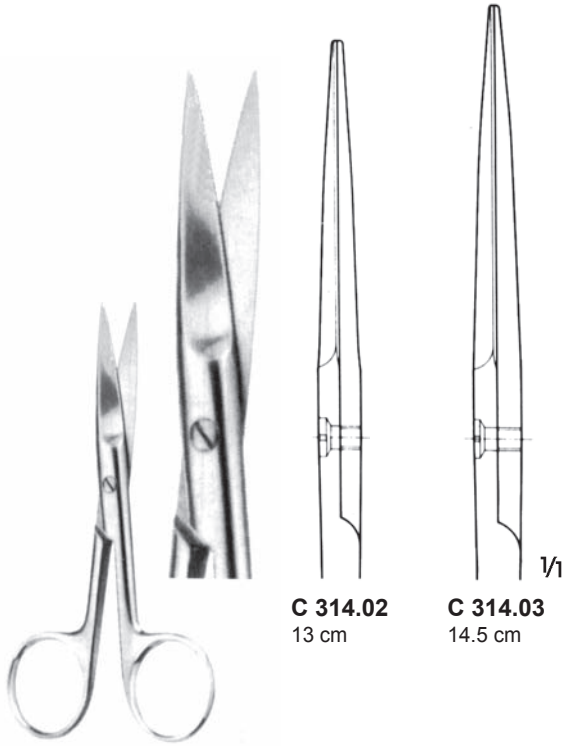

C 314.02 - C 314.03
Sivri/Sharp
Düz/Straight

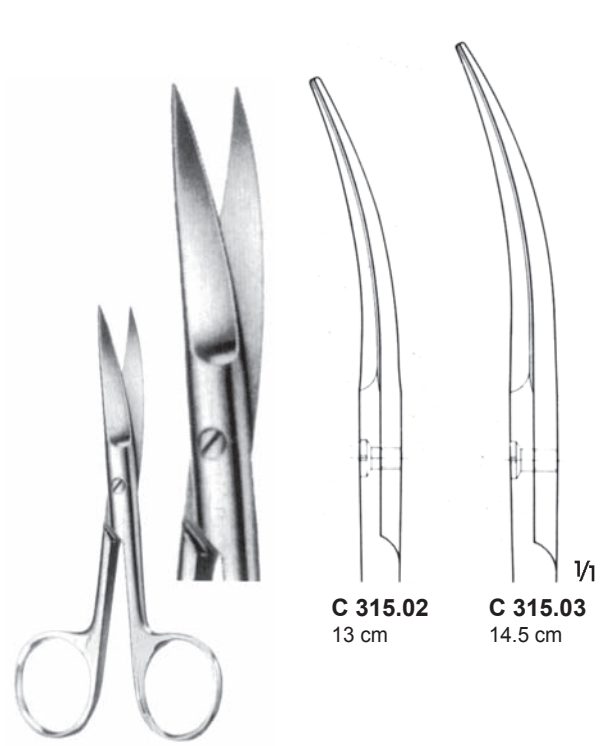

C 315.02 - C 315.03
Sivri/Sharp
Eğri/Curved

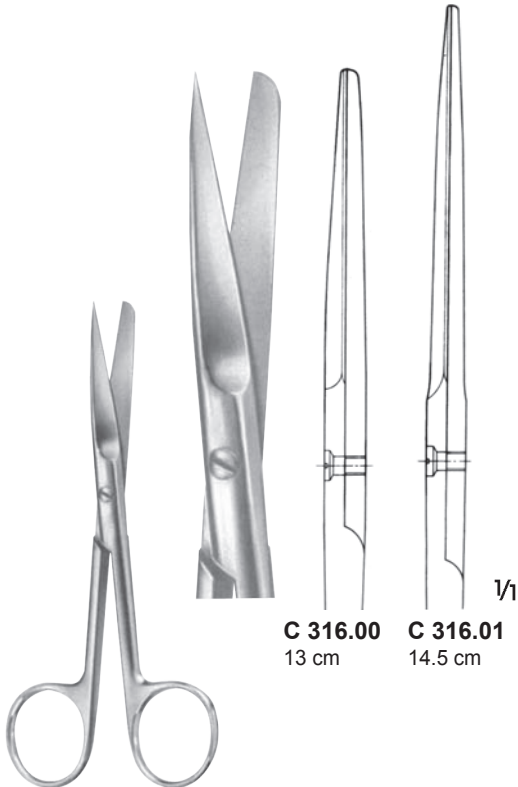

C 316.00 - C 316.01
Sivri/Künt, Düz
Sharp/Blunt, Straight

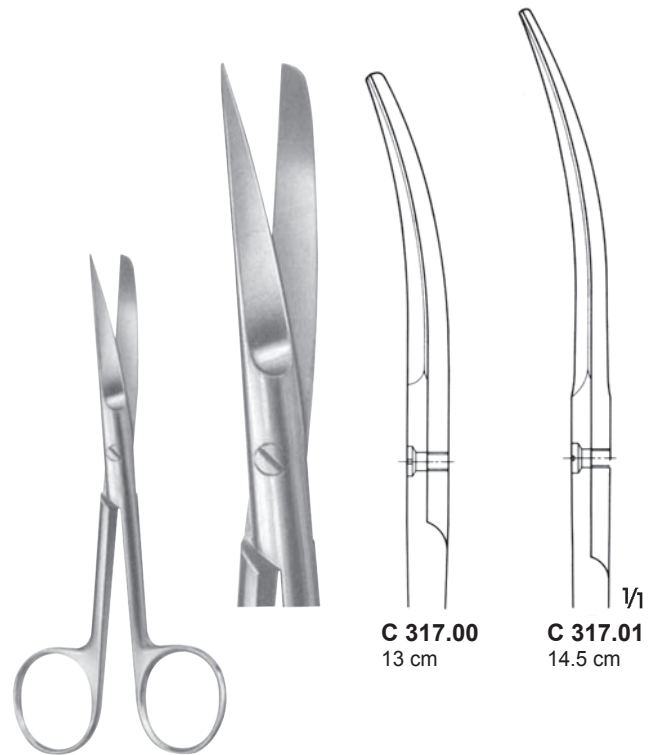

C 317.00 - C 317.01
Sivri/Künt, Eğri
Sharp/Blunt, Curved



GRAEFE
C 360.00
Künt/Blunt
10 cm



C 365.00 Düz/Straight
C 366.00 Eğri/Curved
11.5 cm

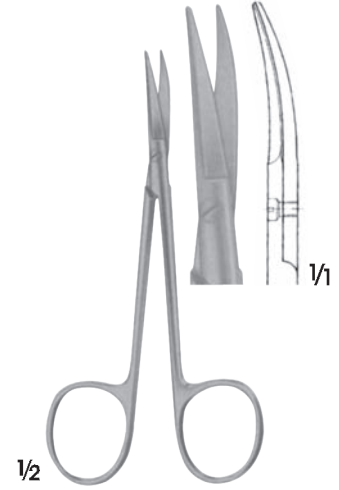
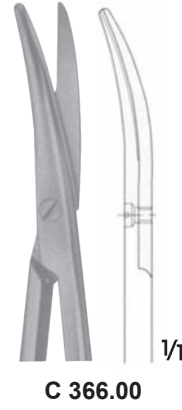

COTTLE
C 368.00
11.5 cm



COTTLE-MASING
C 370.00 - C 371.00
10 cm

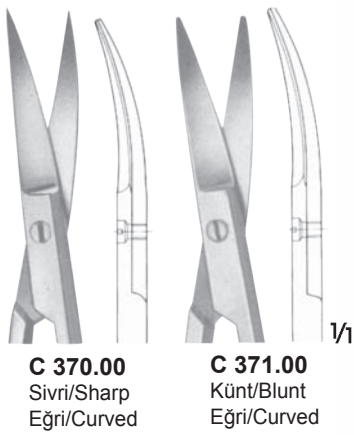

C 370.00
Sivri/Sharp
Eğri/Curved

C 371.00
Künt/Blunt
Eğri/Curved

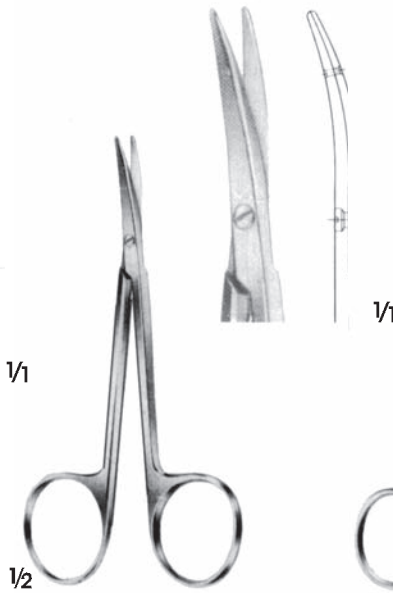

LITTLER
C 380.00
11.5

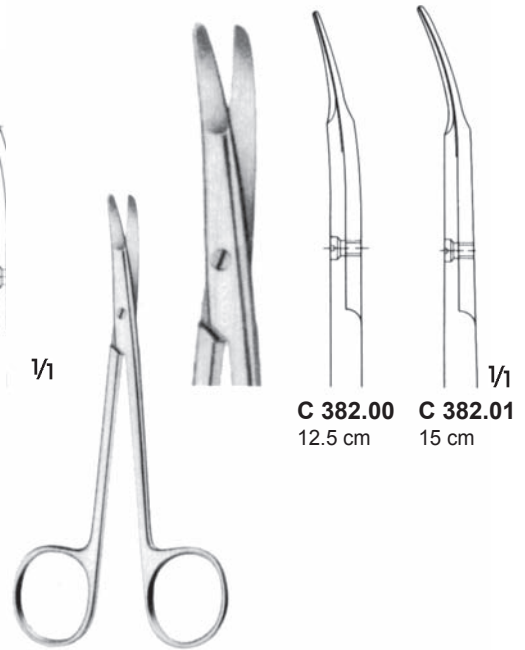

KILNER
C 382.00 - C 382.01

C 382.00
12.5 cm

C 382.01
15 cm



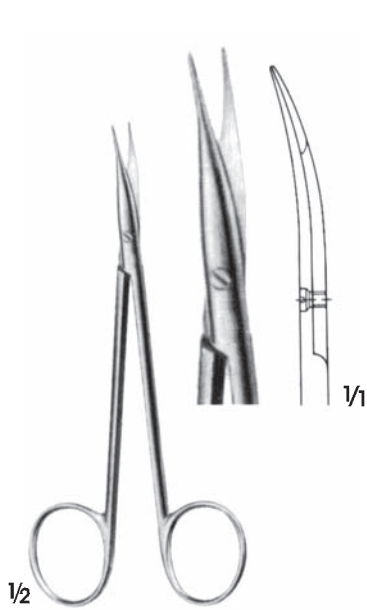

1/2
JAMESON-WERBER
C 385.00
Konik Uçlu/With tapered tips
Künt/Blunt, Eğri/Curved
13 cm



1/2
JAMESON
C 386.00
Konik Uçlu/With tapered tips
Künt/Blunt, Eğri/Curved
15 cm

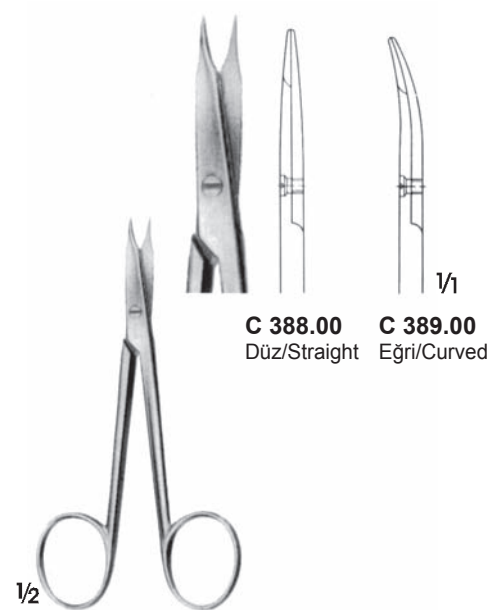

1/2
STEVENS
C 388.00 - C 389.00
10 cm

C 388.00 Düz/Straight
C 389.00 Eğri/Curved

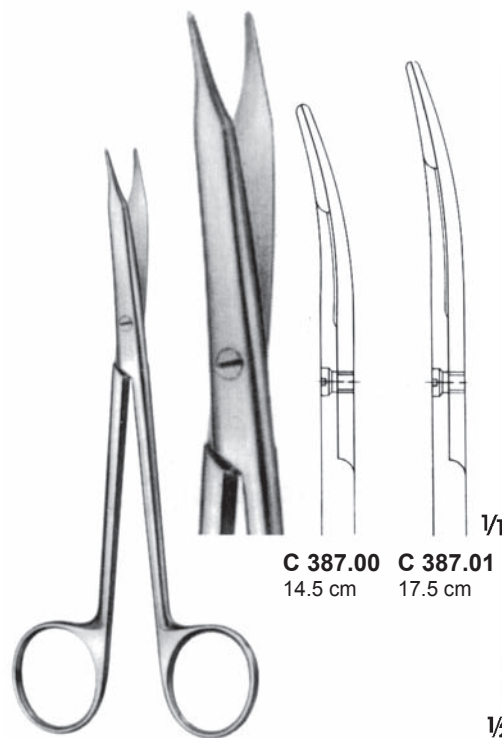

REYNOLDS
C 387.00 - C 387.01
Eğri/Curved

C 387.00 14.5 cm
C 387.01 17.5 cm



1/2
STEVENS
C 390.00 - C 393.00
11 cm

C 390.00 Düz/Straight Sivri/Sharp
C 391.00 Eğri/Curved Sivri/Sharp
C 392.00 Düz/Straight Künt/Blunt
C 393.00 Eğri/Curved Künt/Blunt

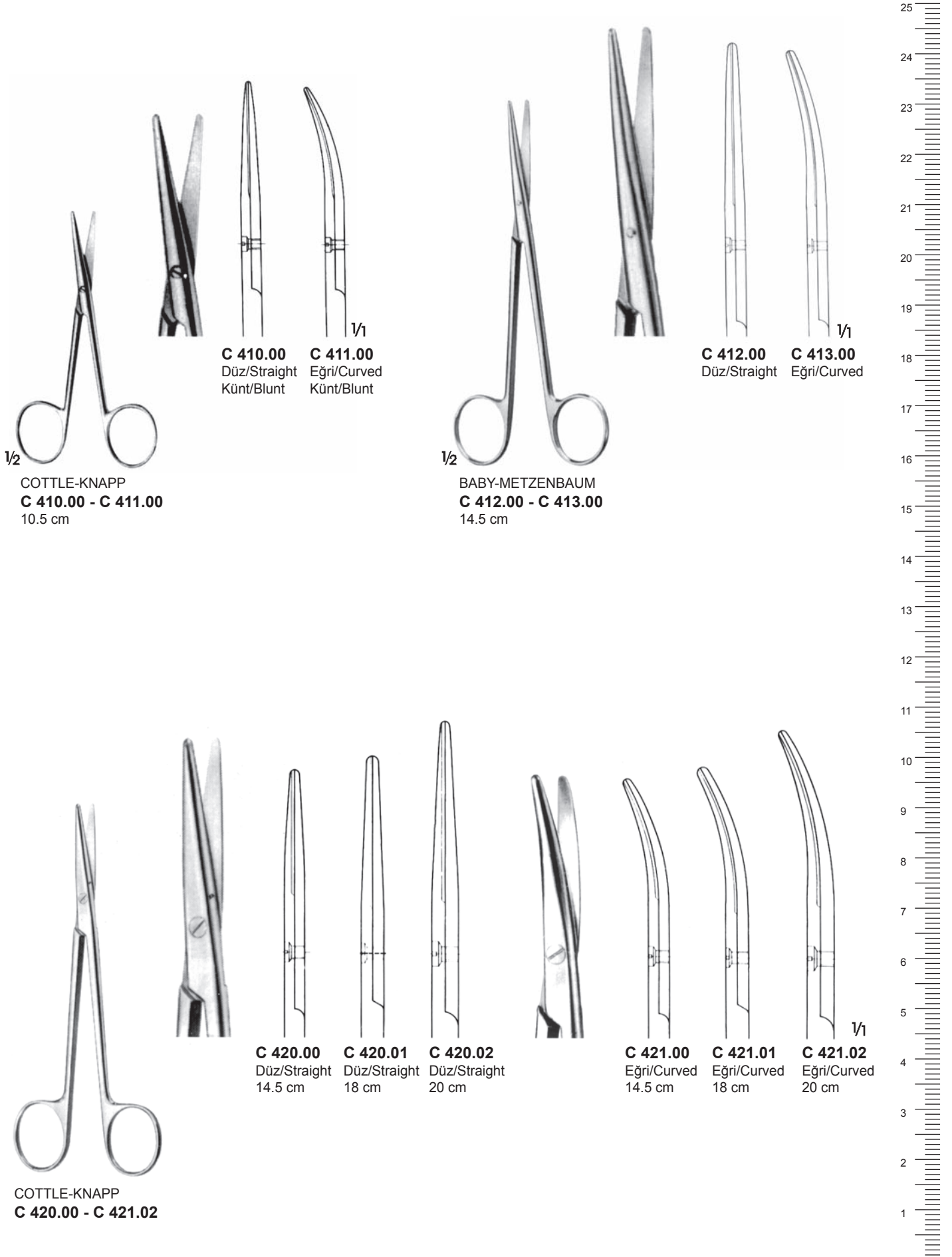

$\frac{1}{2}$
COTTLE-KNAPP
C 410.00 - C 411.00
10.5 cm

C 410.00
Düz/Straight
Künt/Blunt

C 411.00
Eğri/Curved
Künt/Blunt

$\frac{1}{2}$
BABY-METZENBAUM
C 412.00 - C 413.00
14.5 cm

C 412.00
Düz/Straight

C 413.00
Eğri/Curved



COTTLE-KNAPP
C 420.00 - C 421.02



C 420.00
Düz/Straight
14.5 cm



C 420.01
Düz/Straight
18 cm



C 420.02
Düz/Straight
20 cm



C 421.00
Eğri/Curved
14.5 cm



C 421.01
Eğri/Curved
18 cm



C 421.02
Eğri/Curved
20 cm

$\frac{1}{1}$

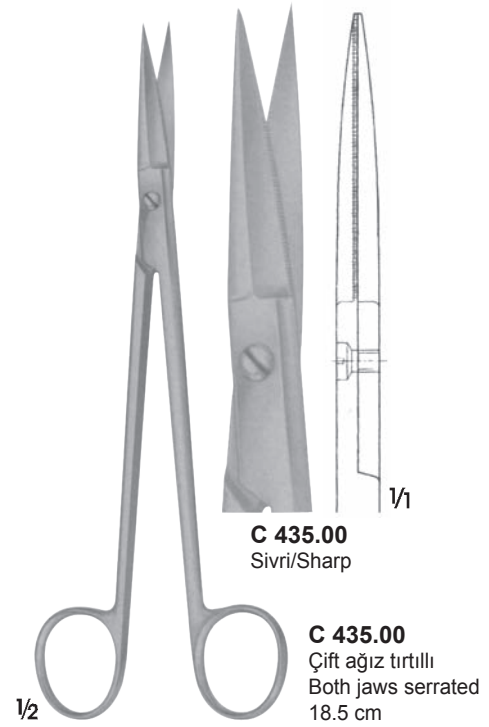
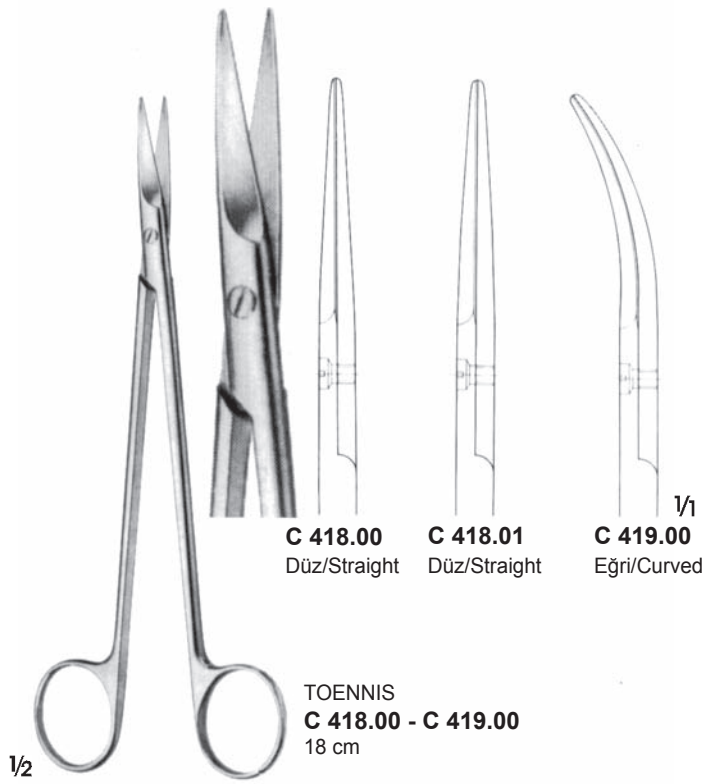
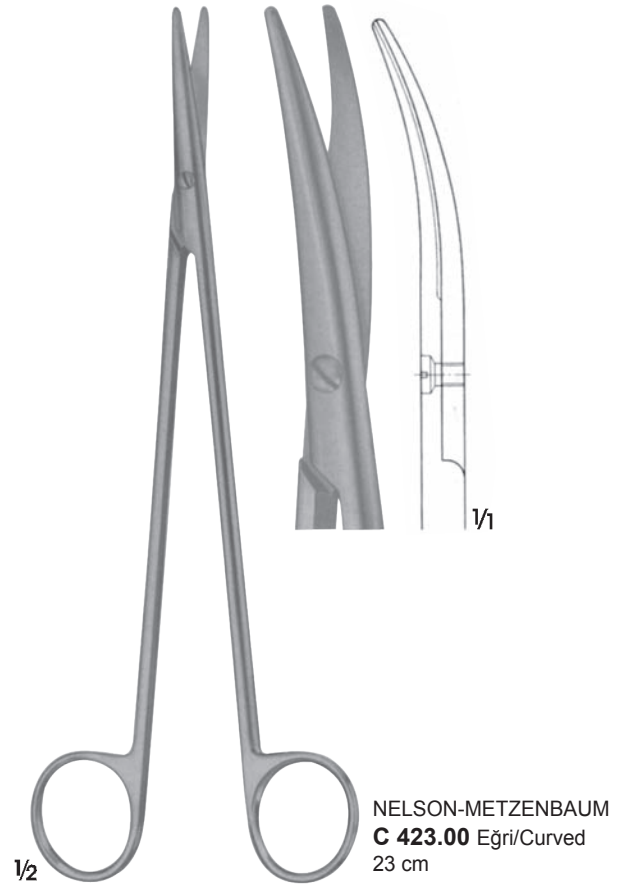
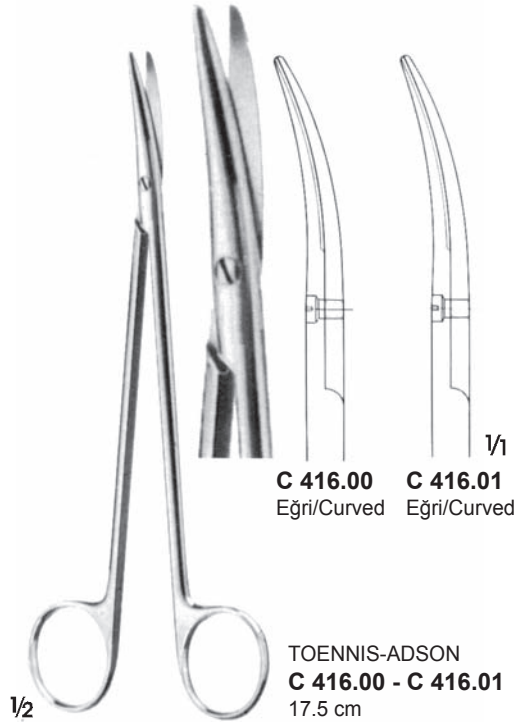

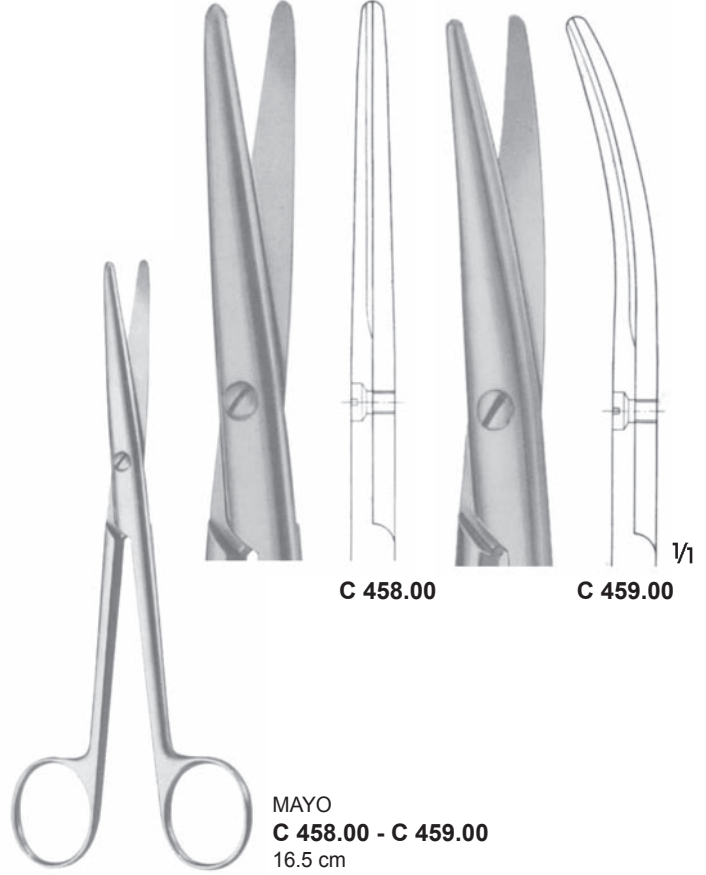
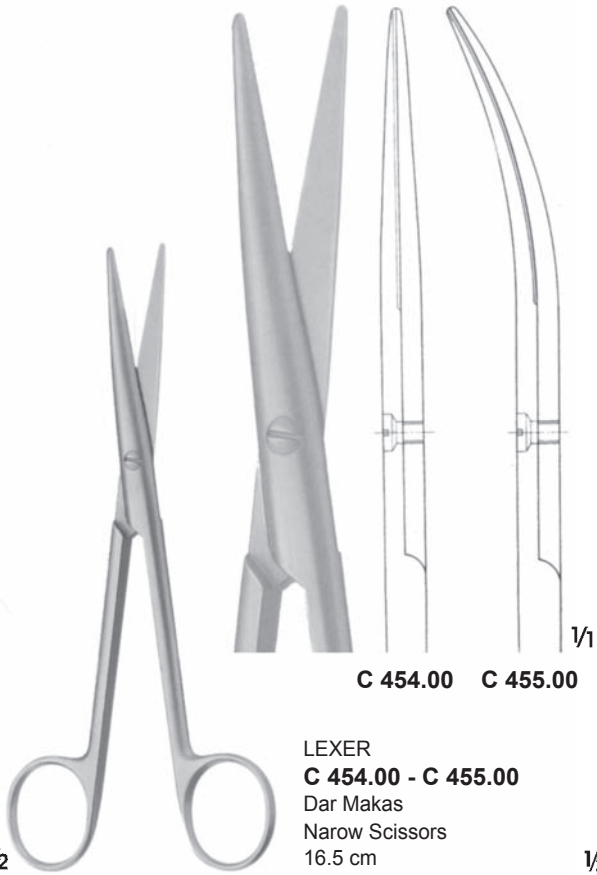
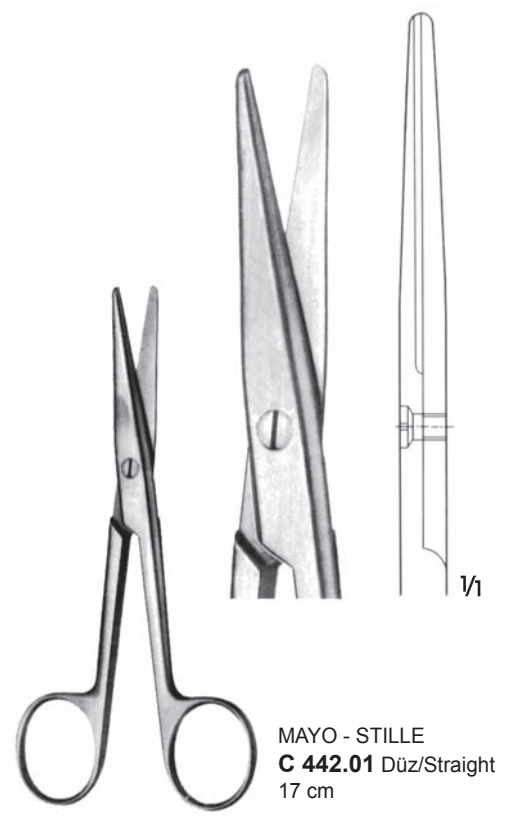
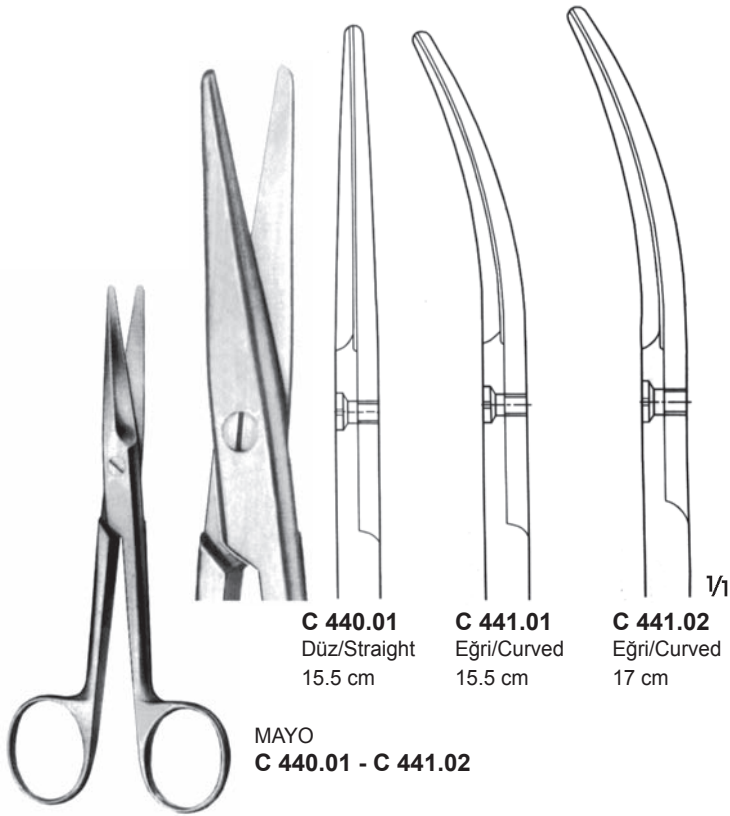

Karbür kesme ucu yerleştirilmiş HardTips makaslar

- Mükemmel kesim
- Uzun çalışma ömrü

HardTips scissors with inserted carbide cutting edges

- Excellent Cutting
- Long working

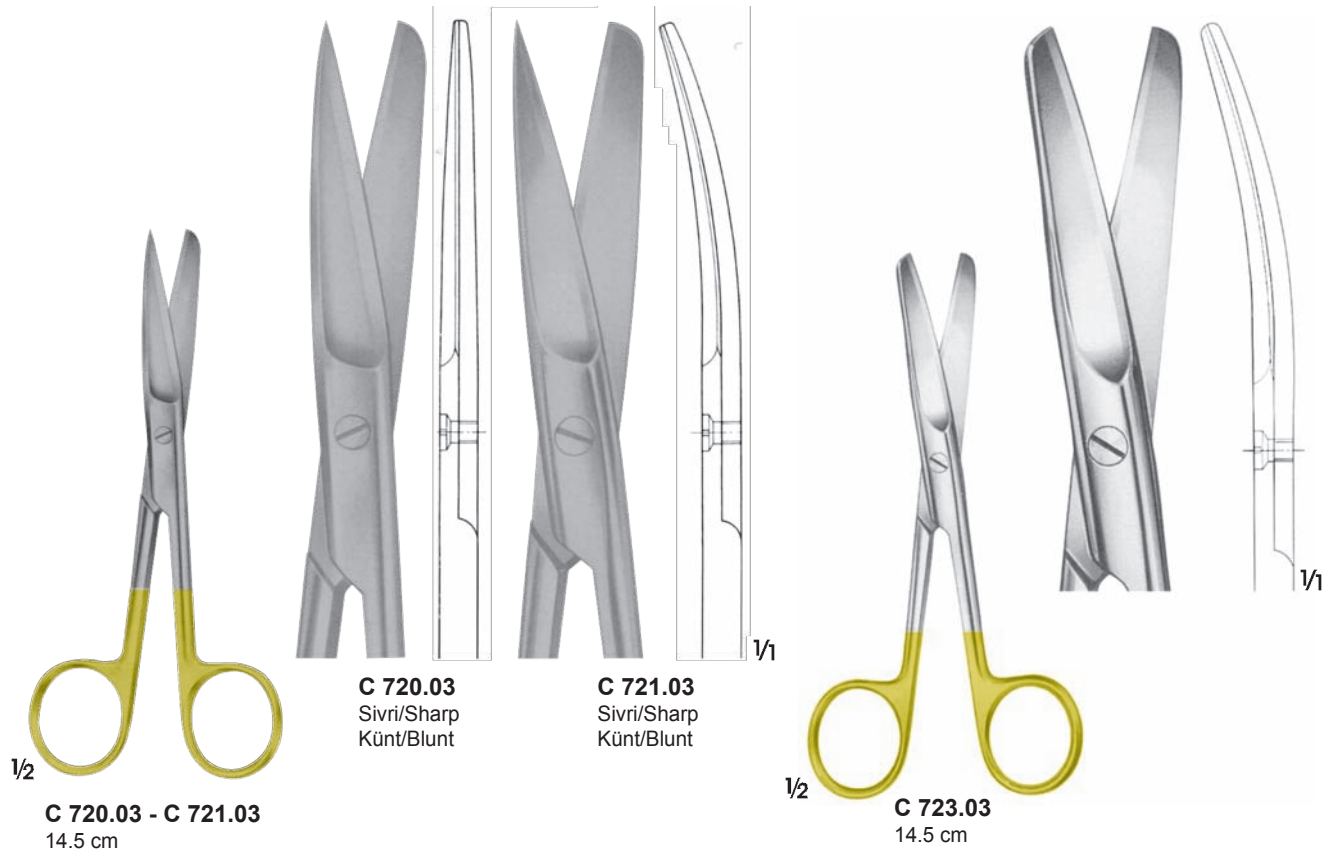

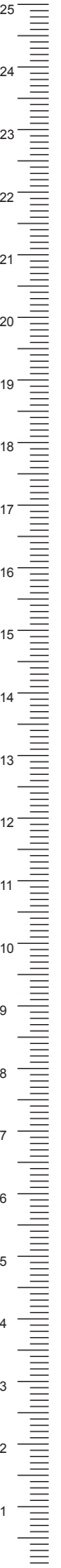
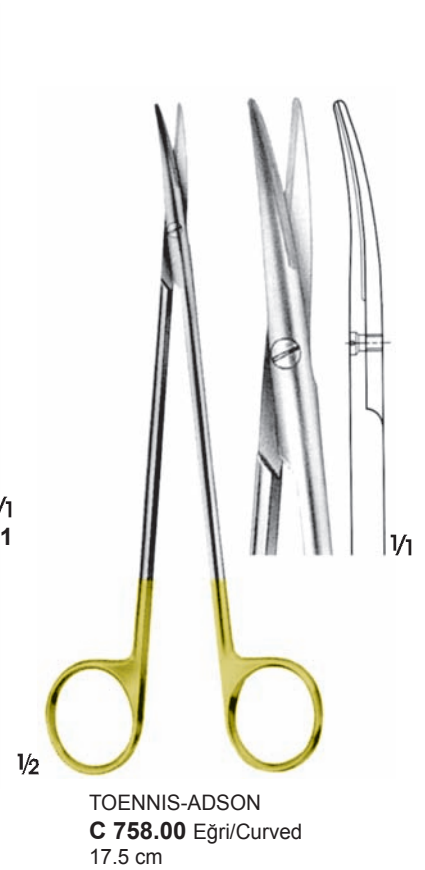
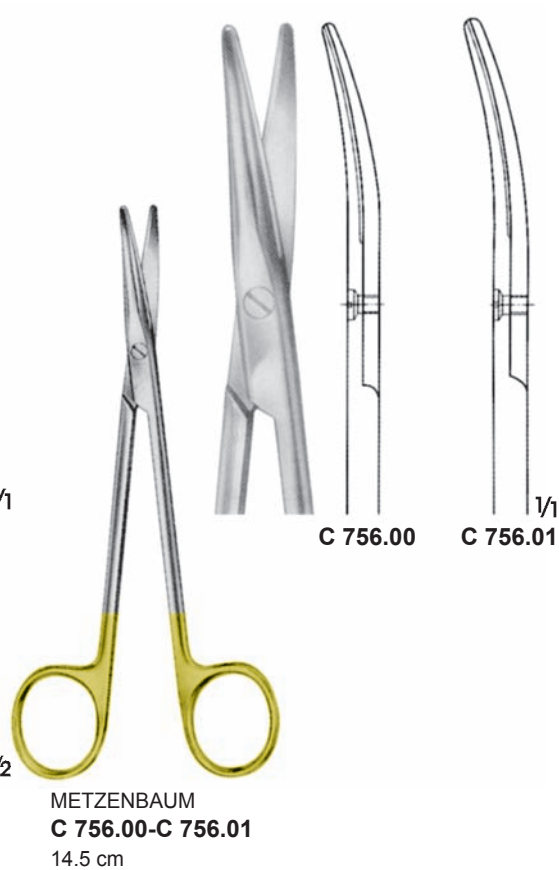

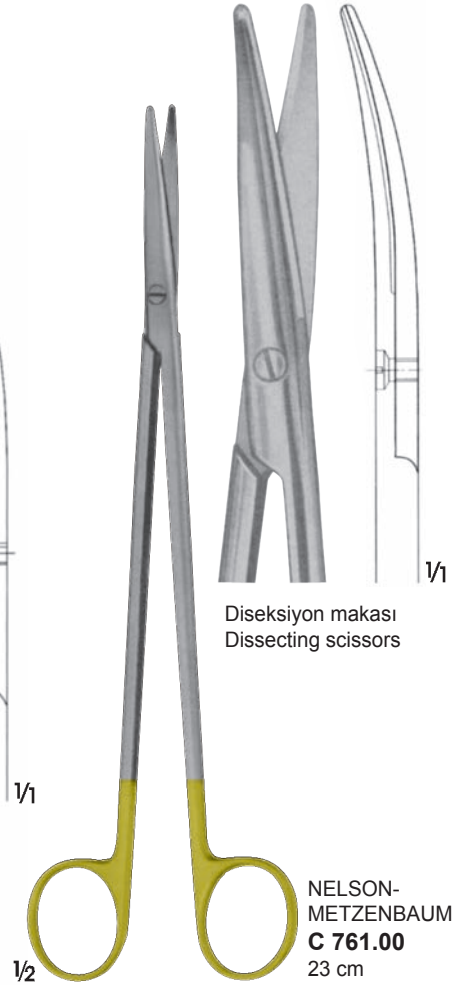
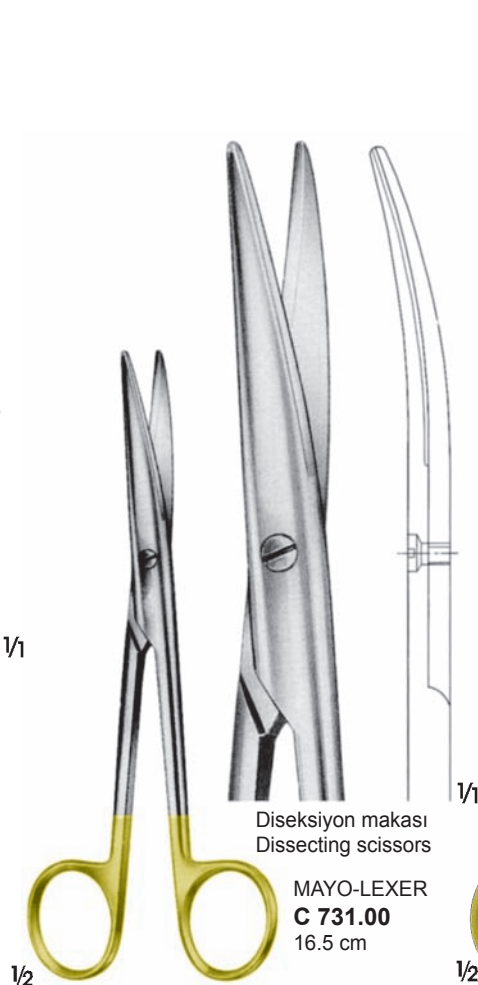
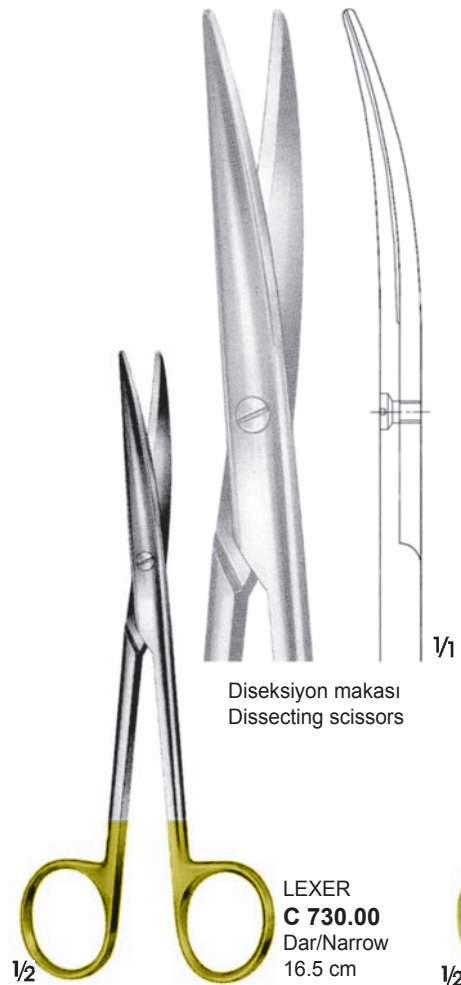
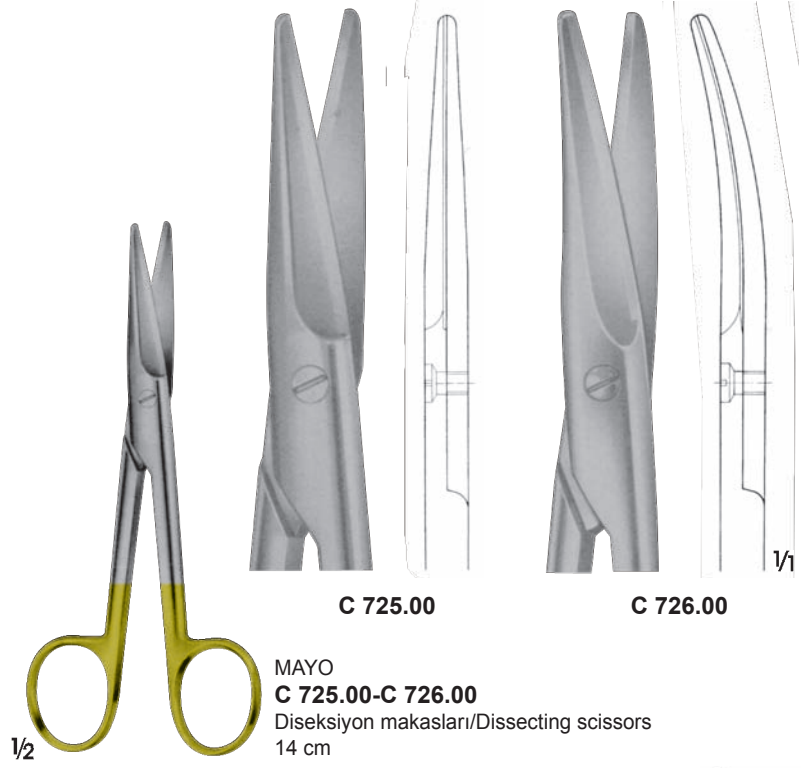
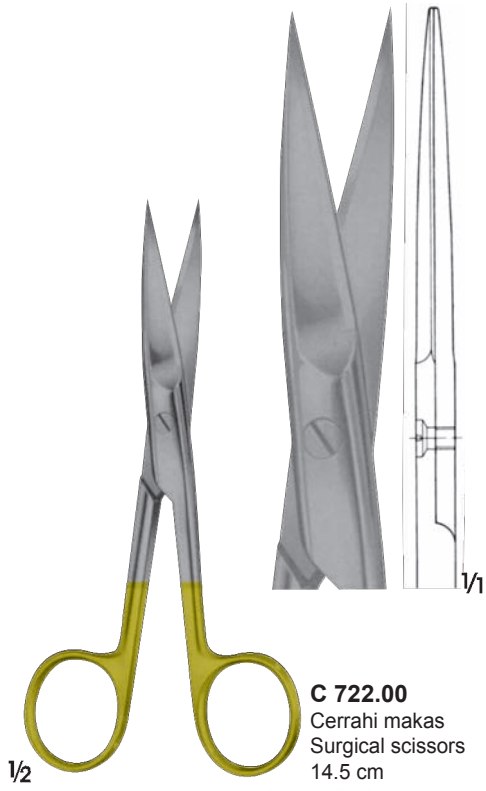

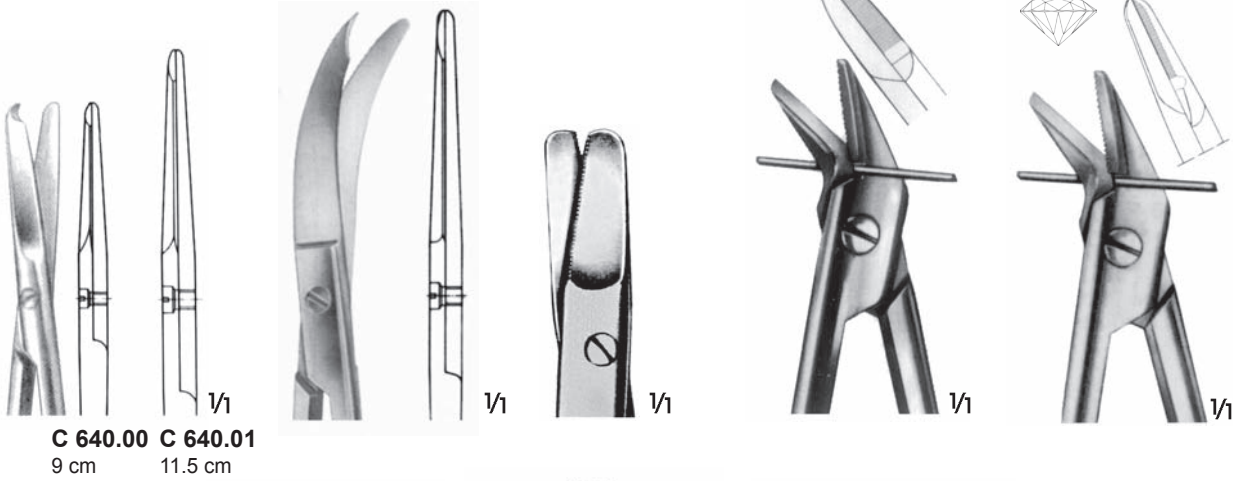

C 640.00 **C 640.01**
9 cm 11.5 cm

1/1

1/1

1/1

1/1



SPENCER
C 640.00 - C 640.01

NORTHBENT
C 643.00
12 cm

HARVEY
C 666.00
Çift ağız tırtıllı
Both jaws serrated
12.5 cm

C 668.00
Tek ağız tırtıllı
One jaw serrated
12 cm

C 798.00
Tek ağız tırtıllı
One jaw serrated
12 cm

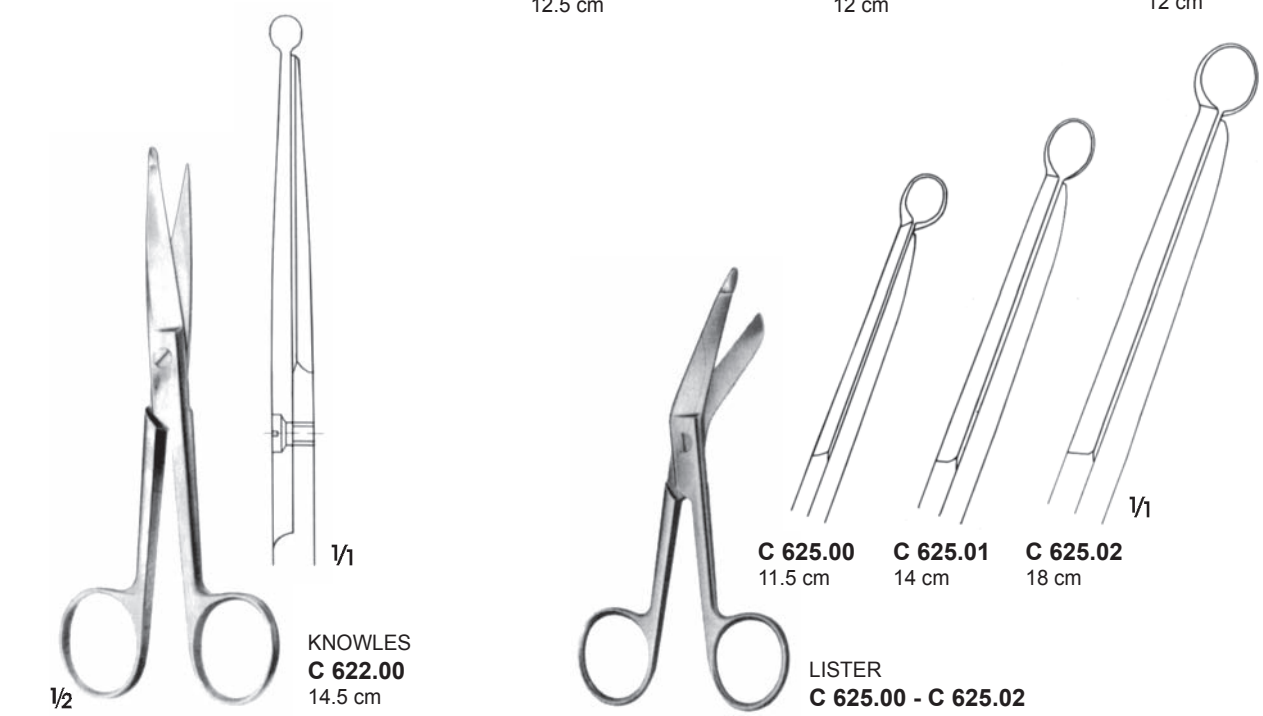

KNOWLES
C 622.00
14.5 cm

C 625.00 11.5 cm
C 625.01 14 cm
C 625.02 18 cm

LISTER
C 625.00 - C 625.02

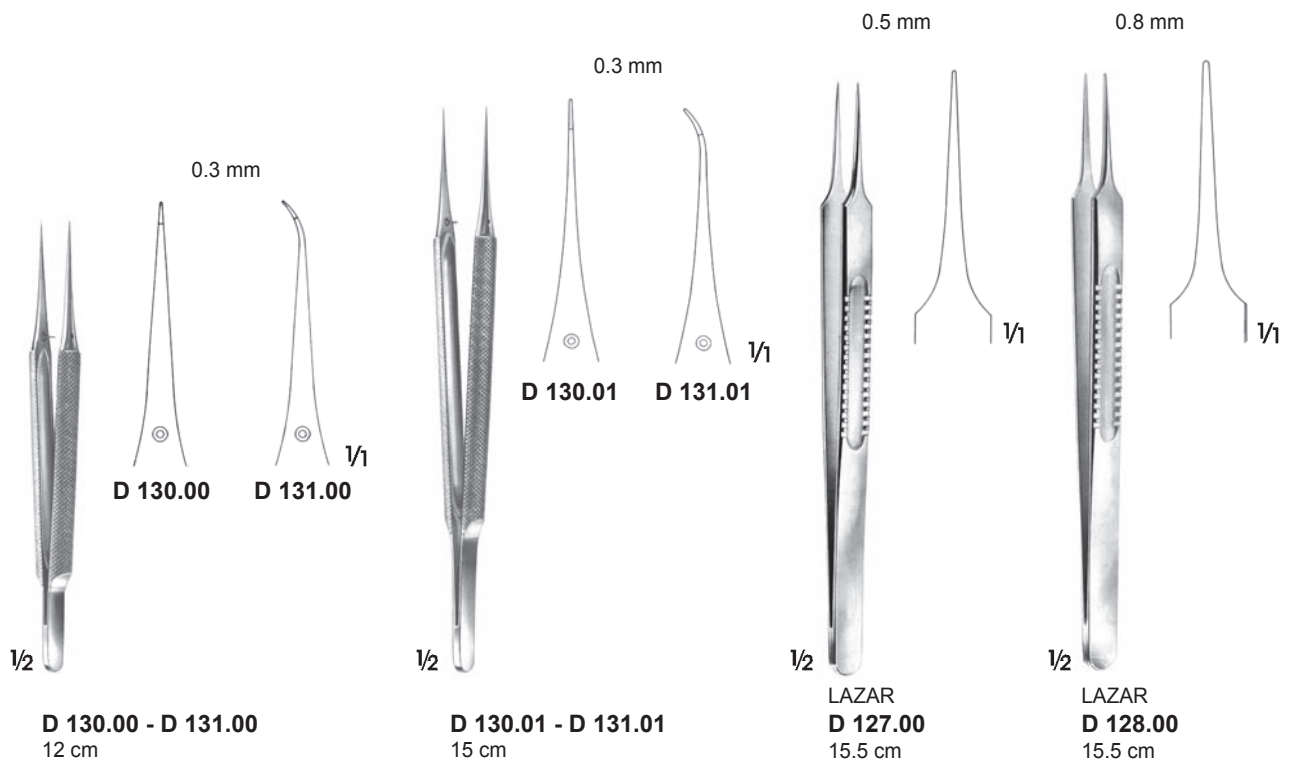
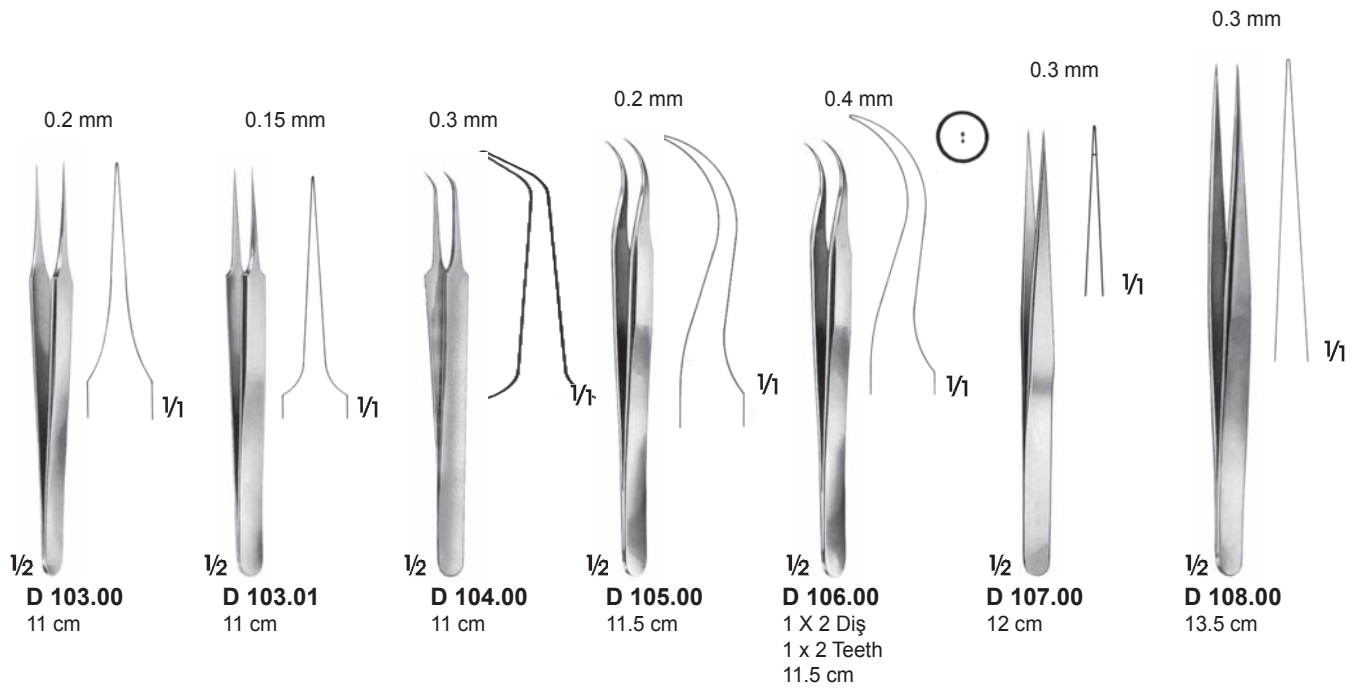

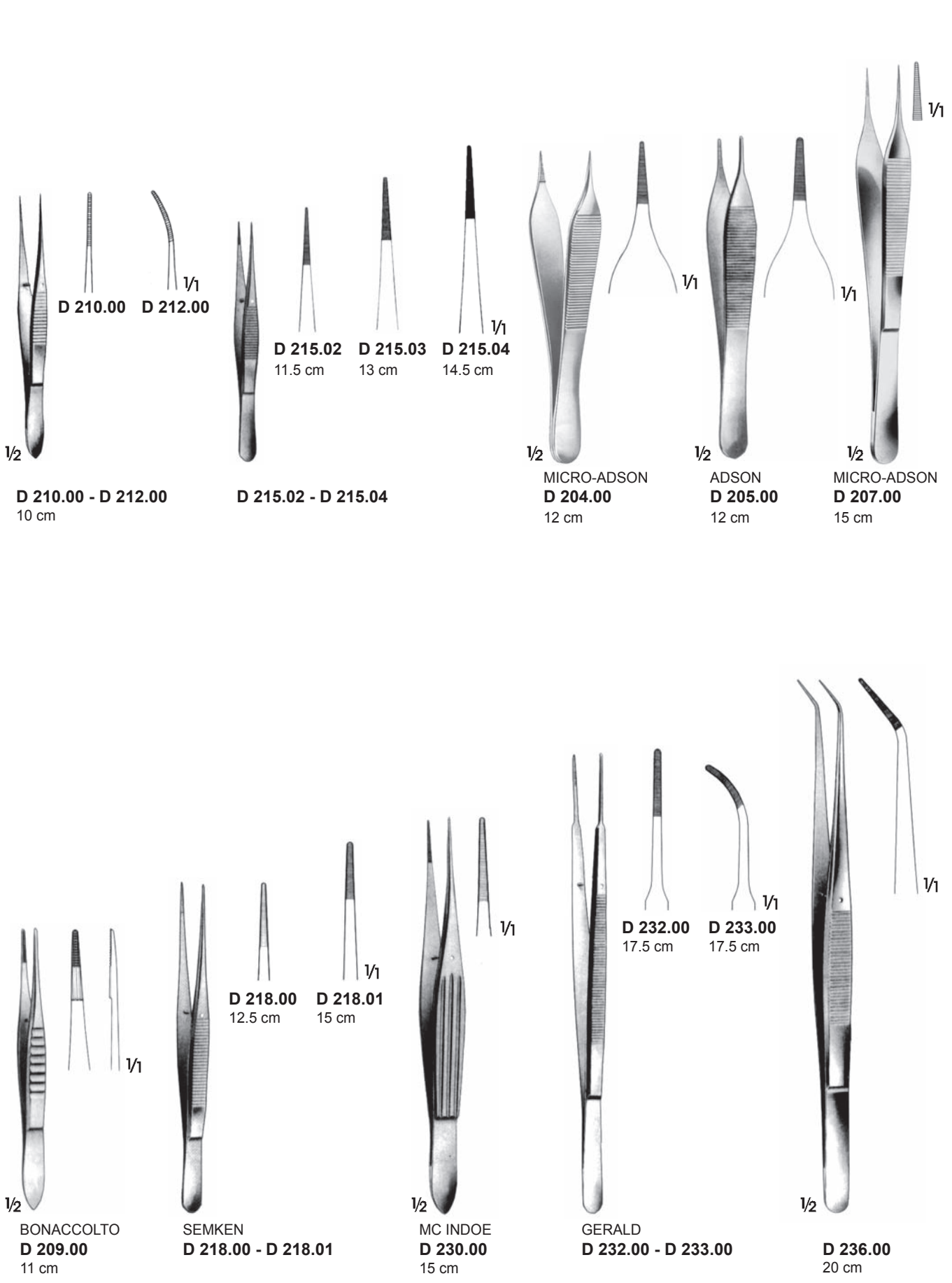

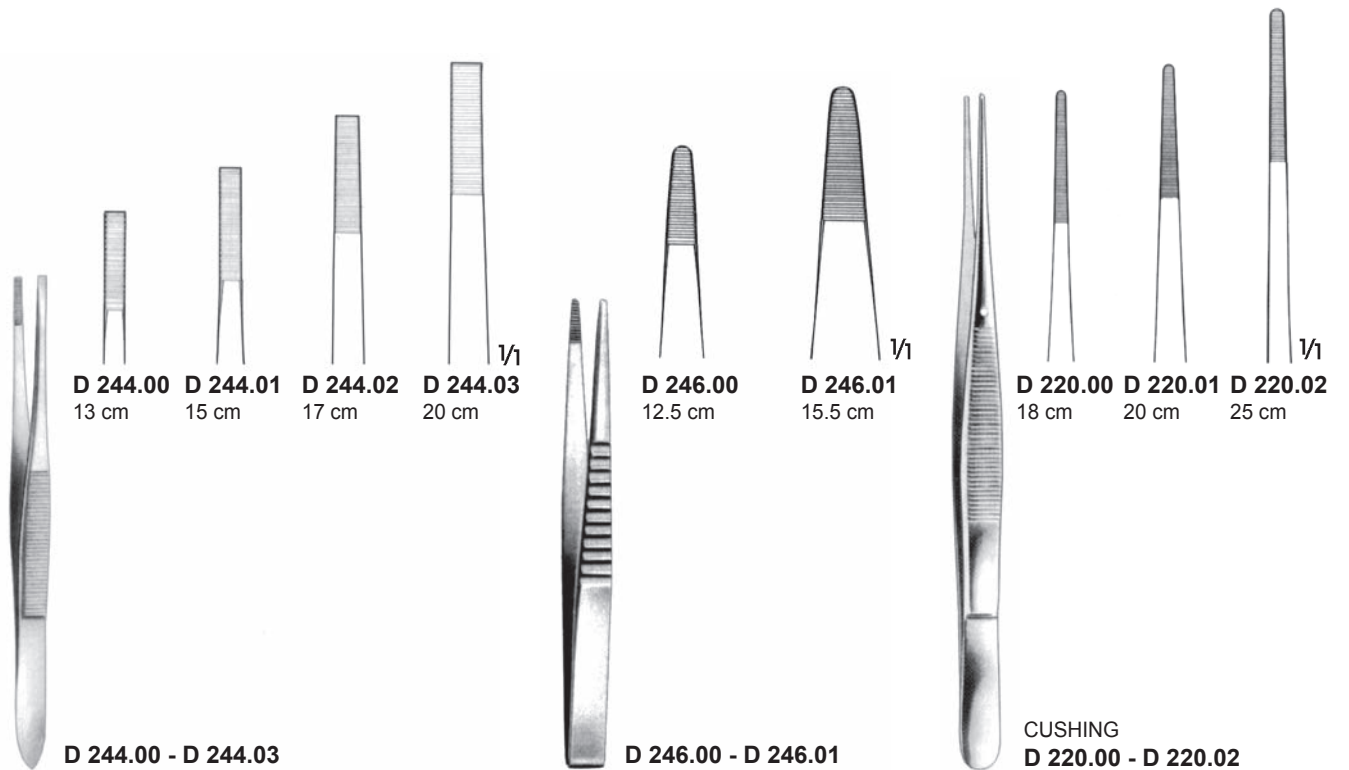
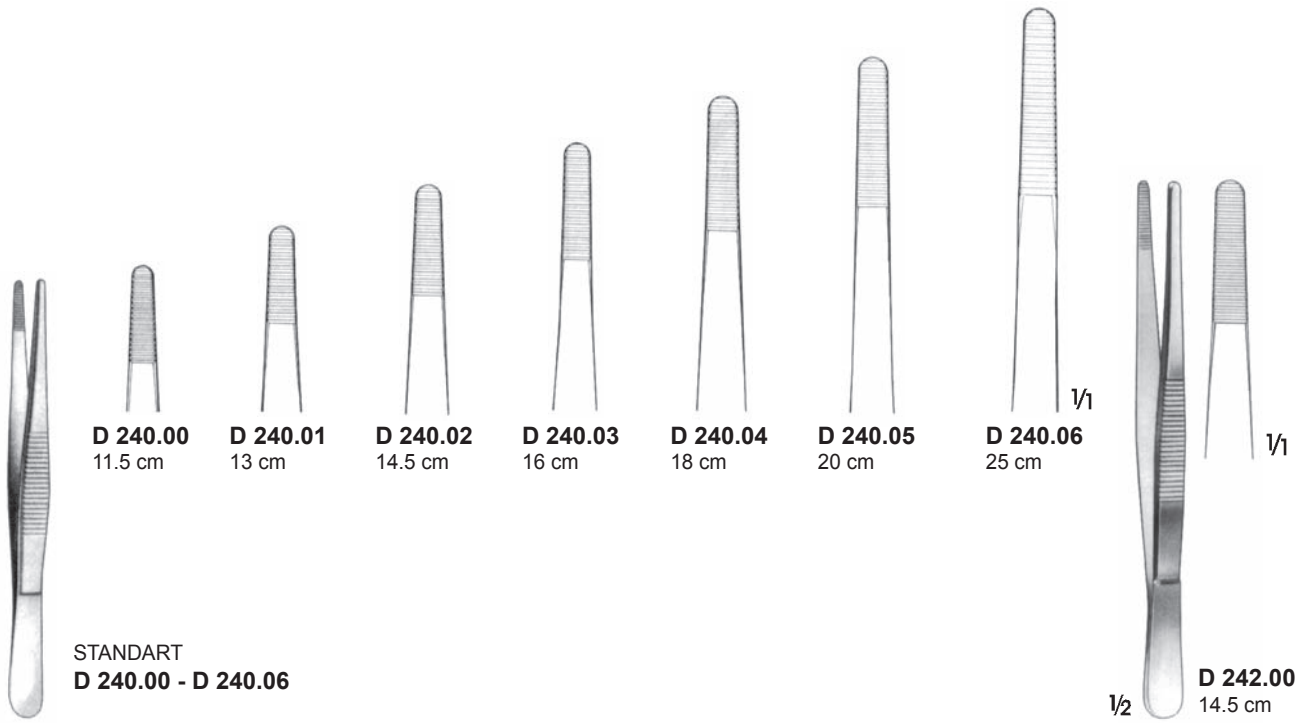

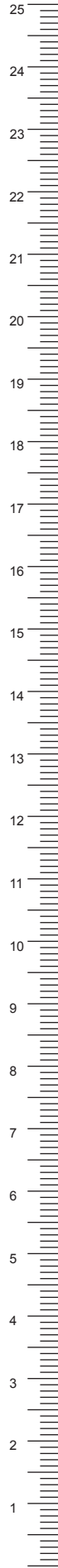
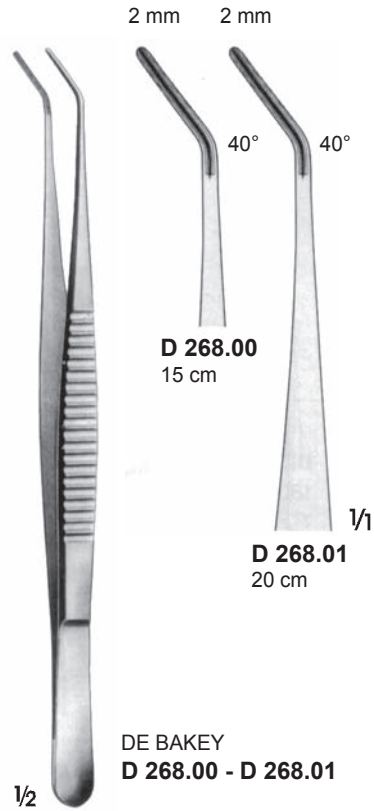
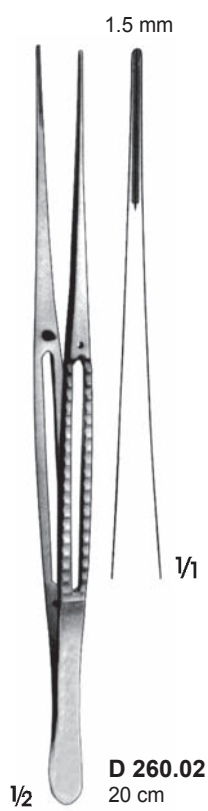
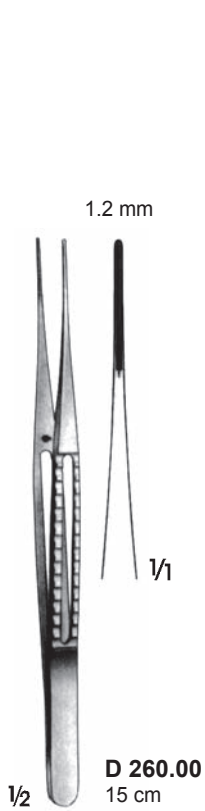
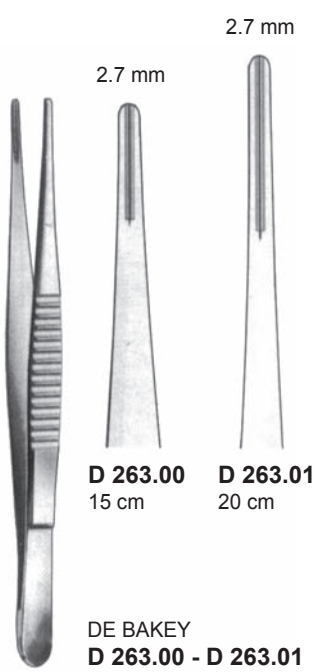

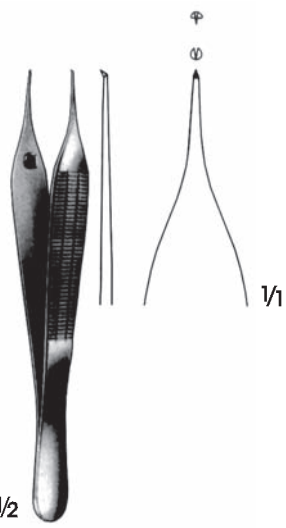

1/2
MICRO-ADSON-BIEMER
D 320.00
12 cm



1/2
MICRO-ADSON
D 322.00
12 cm

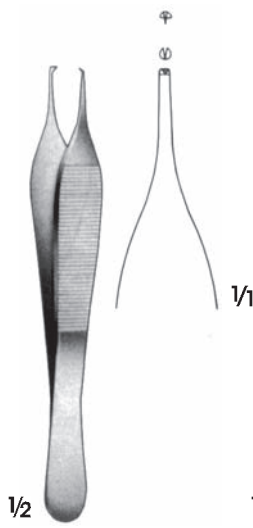

1/2
ADSON
D 323.00
12 cm



1/2
ADSON
D 324.00
12 cm

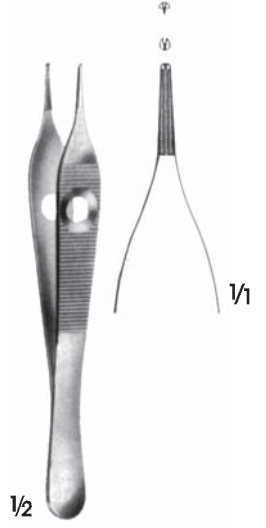

1/2
ADSON
D 325.01
12 cm



1/2
MICRO-ADSON
D 327.00
15 cm



1/2
ADSON
D 329.00
15 cm



1/2
ADSON-BROWN
D 340.00
12 cm



1/2
BROWN
D 341.00
15 cm



1/2
COTTLE
D 151.01
10 cm

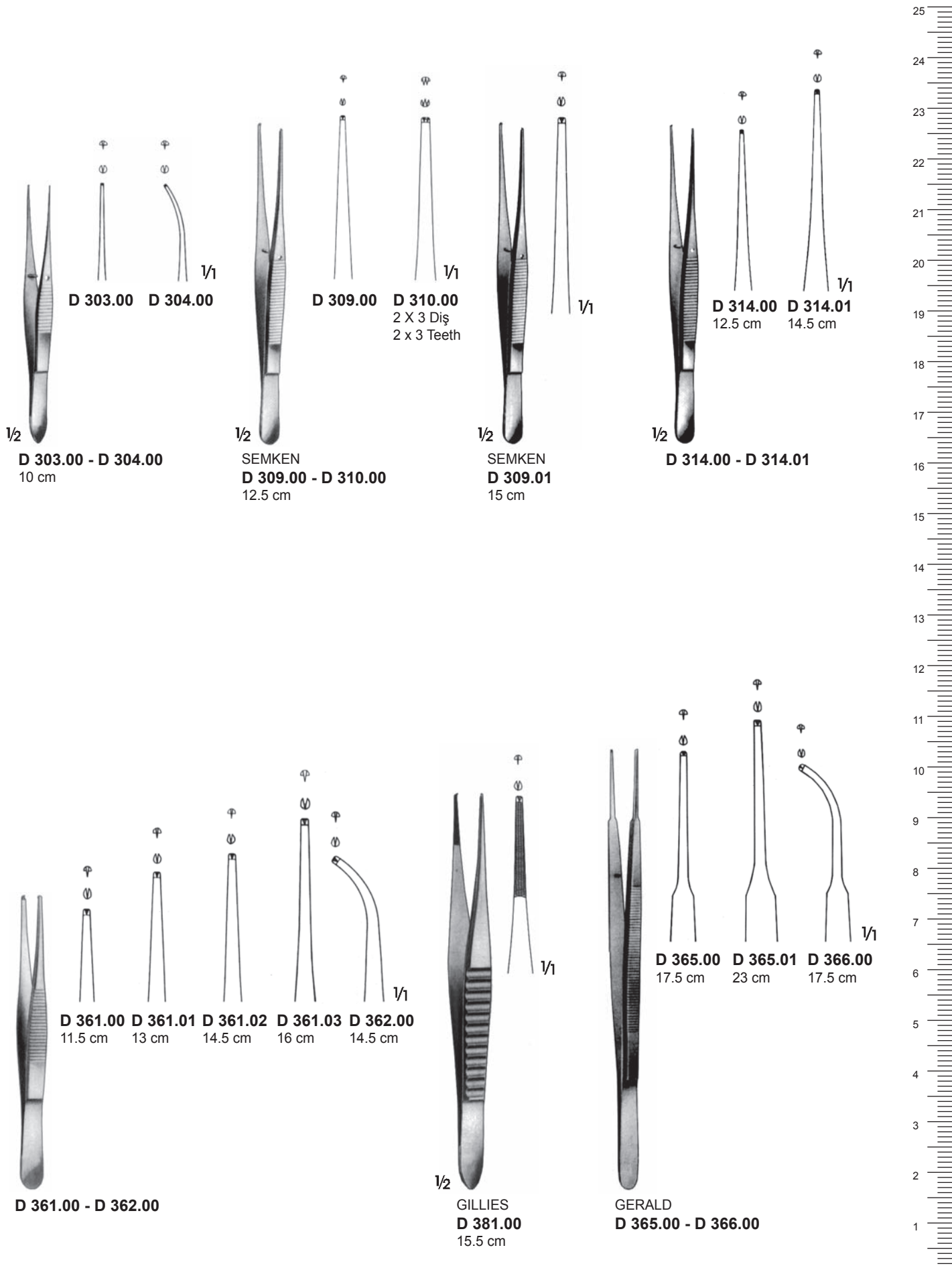

The image displays various dental tissue forceps models, each with a technical drawing and a photograph. A vertical ruler on the right side indicates measurements in centimeters, ranging from 1 to 25.

Model 1: D 303.00, D 304.00. Length: 10 cm. Ratio: 1/2 (photo), 1/1 (drawing).

Model 2: SEMKEN D 309.00, D 310.00. Length: 12.5 cm. Ratio: 1/2 (photo), 1/1 (drawing). Description: 2 X 3 Diş / 2 x 3 Teeth.

Model 3: SEMKEN D 309.01. Length: 15 cm. Ratio: 1/2 (photo), 1/1 (drawing).

Model 4: D 314.00, D 314.01. Length: 12.5 cm and 14.5 cm. Ratio: 1/2 (photo), 1/1 (drawing).

Model 5: D 361.00, D 361.01, D 361.02, D 361.03, D 362.00. Lengths: 11.5 cm, 13 cm, 14.5 cm, 16 cm, 14.5 cm. Ratio: 1/2 (photo), 1/1 (drawing).

Model 6: GILLIES D 381.00. Length: 15.5 cm. Ratio: 1/2 (photo), 1/1 (drawing).

Model 7: GERALD D 365.00, D 365.01, D 366.00. Lengths: 17.5 cm, 23 cm, 17.5 cm. Ratio: 1/2 (photo), 1/1 (drawing).

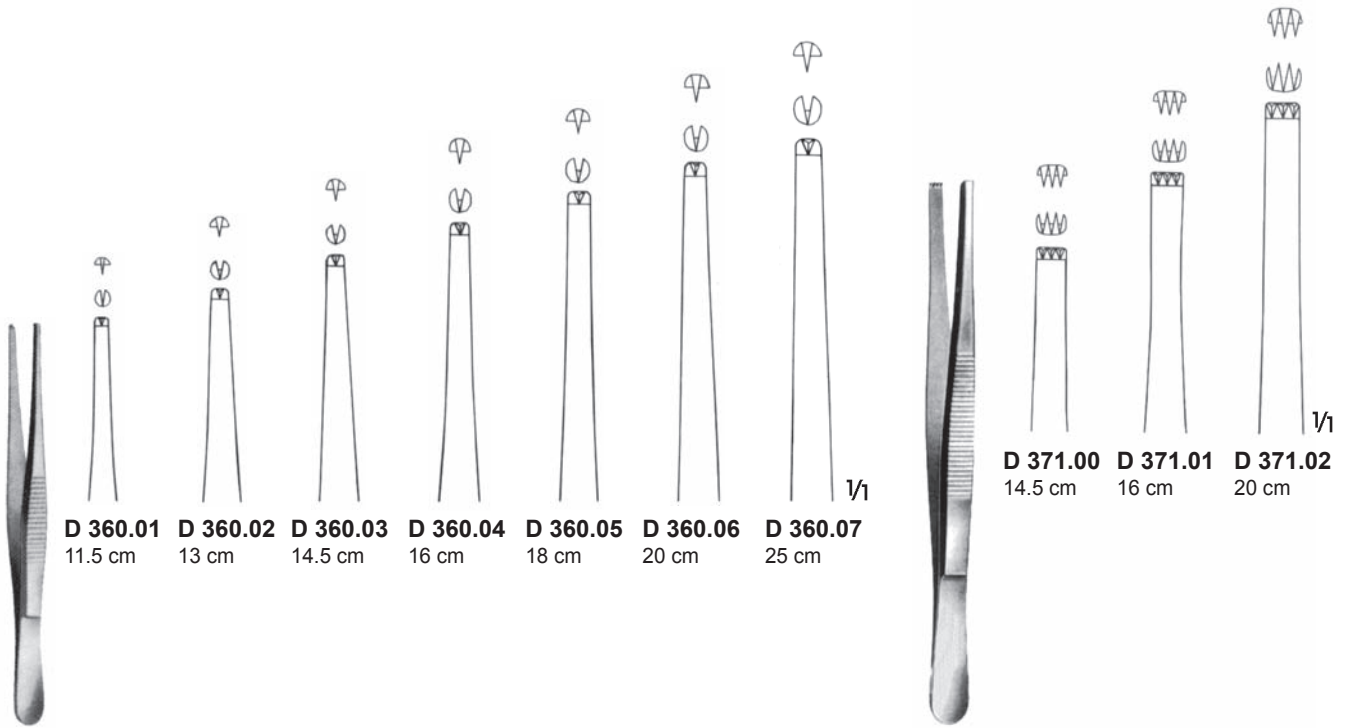

STANDART
D 360.01 - D 360.07

STANDART
D 371.00 - D 371.02
3 X 4 Diş/3 x 4 Teeth

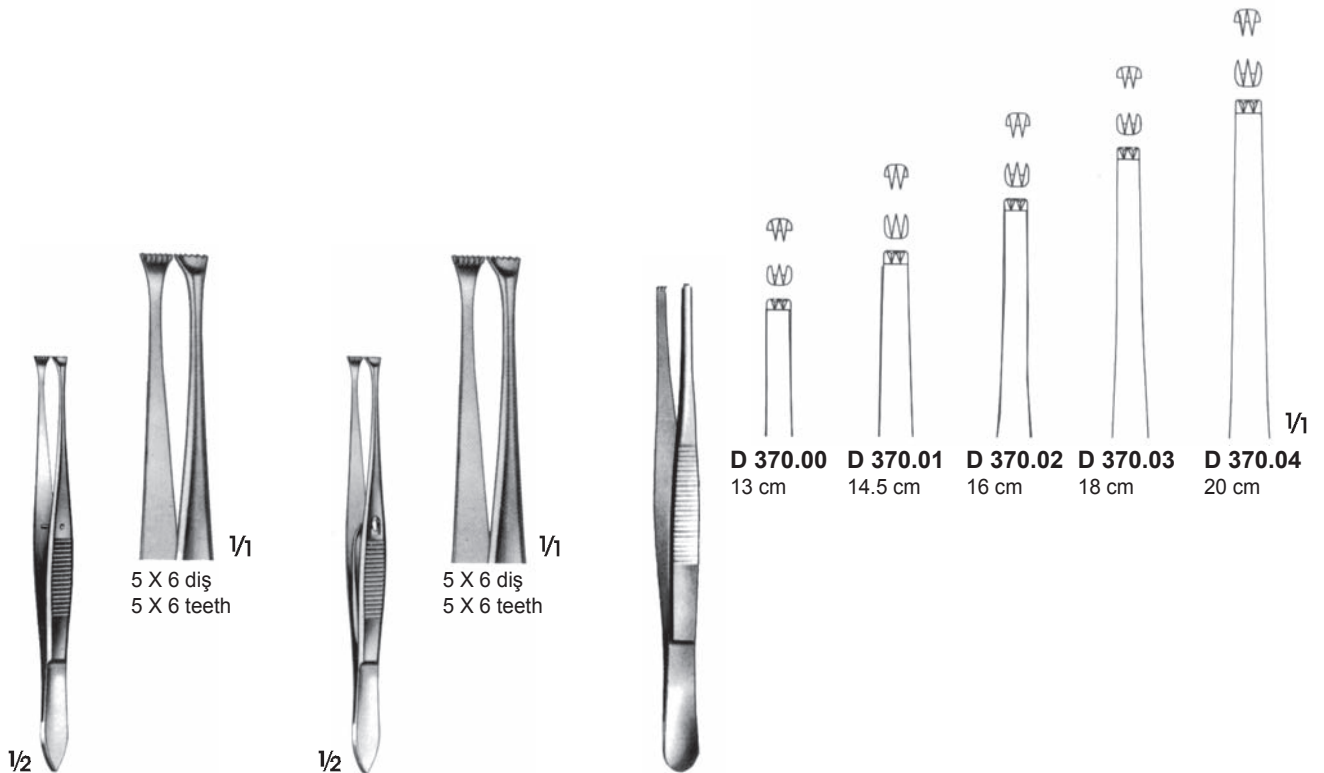

GRAEFE
D 351.00
11 cm

GRAEFE
D 352.01
Kilitli/With catch
11 cm

D 370.00 - D 370.04
2 X 3 Diş/2 x 3 Teeth

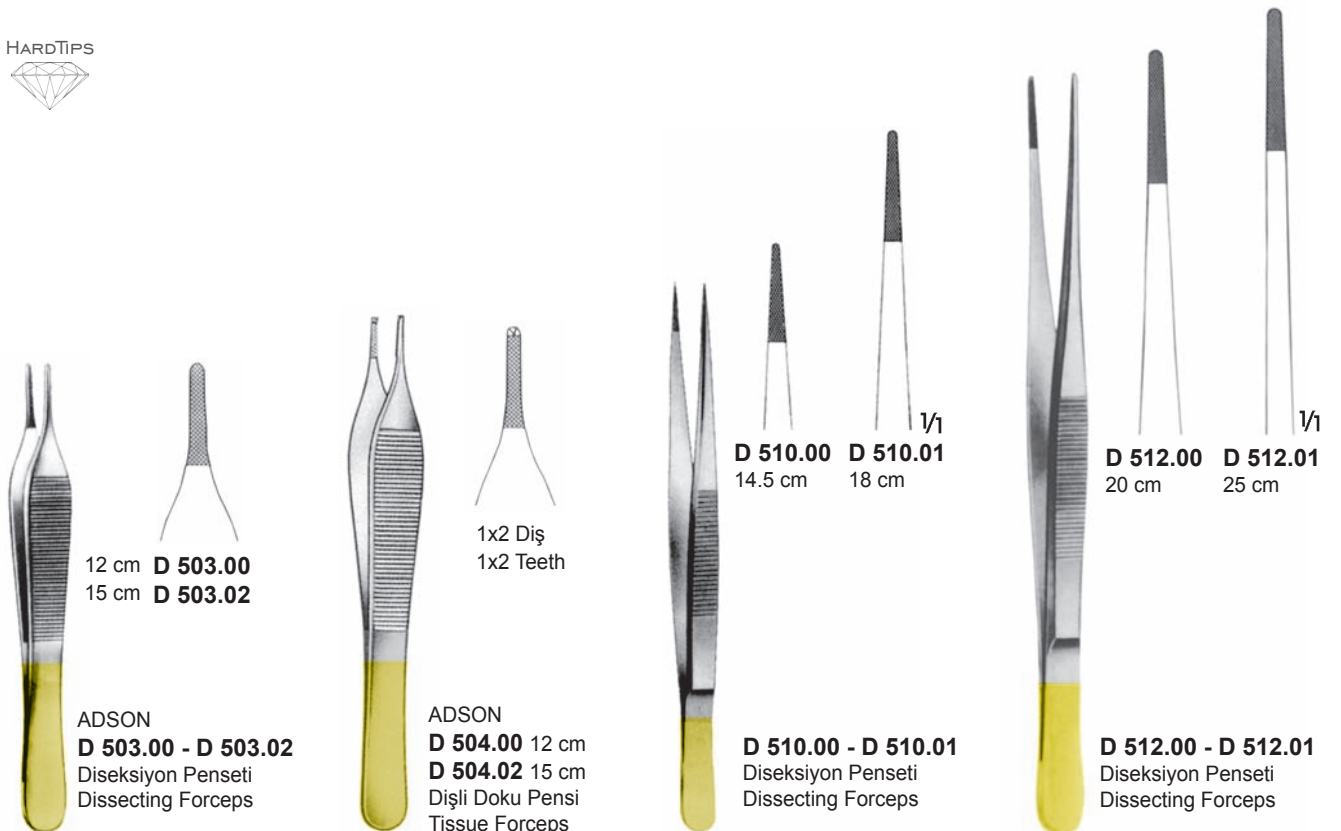
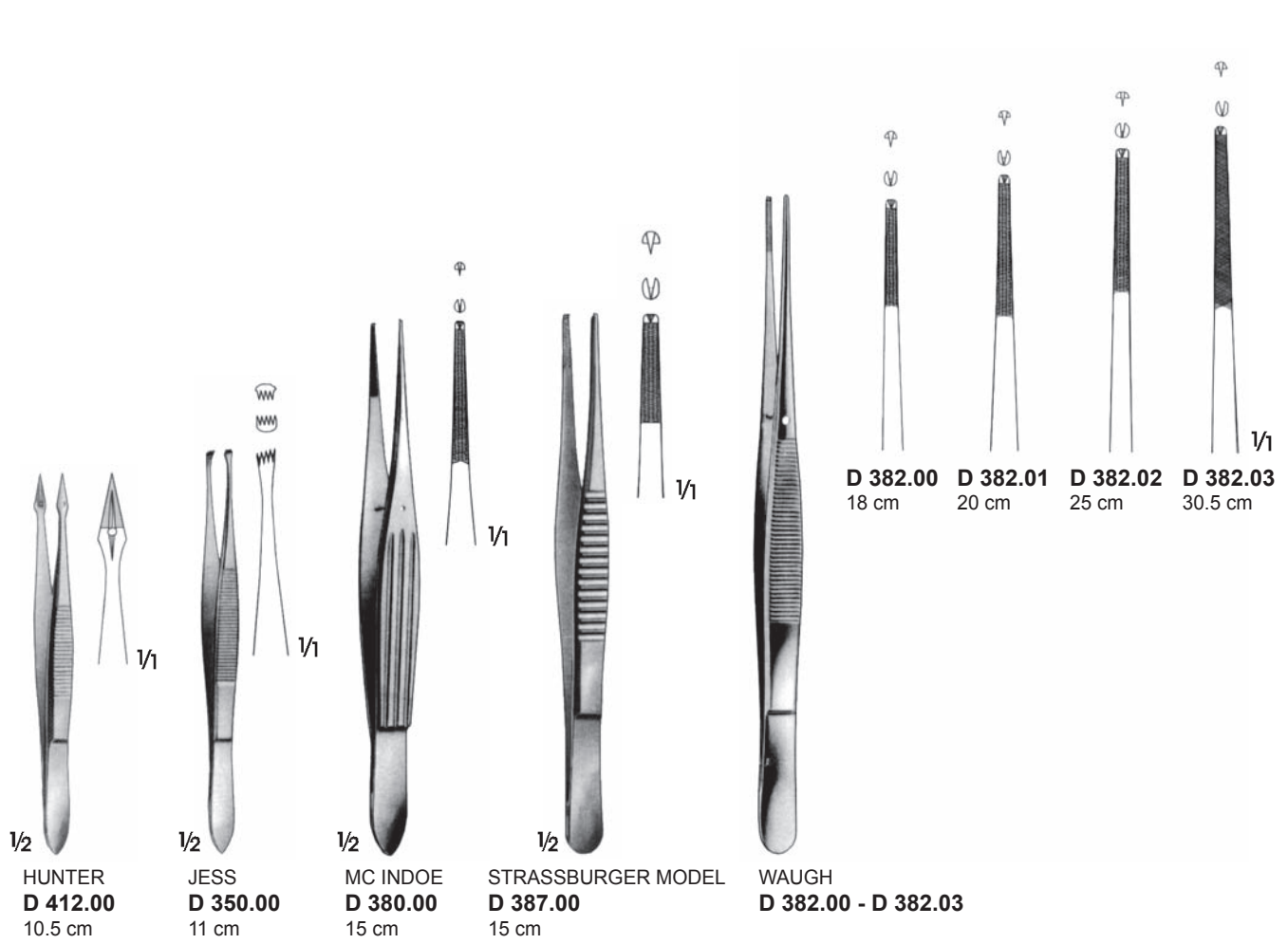

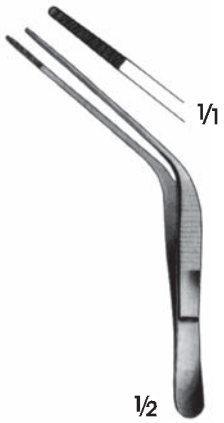

$\frac{1}{2}$
TROELTSCH
D 156.00
10 cm



$\frac{1}{2}$
TROELTSCH
D 156.01
11.5 cm



$\frac{1}{2}$
TROELTSCH
D 156.02
14 cm

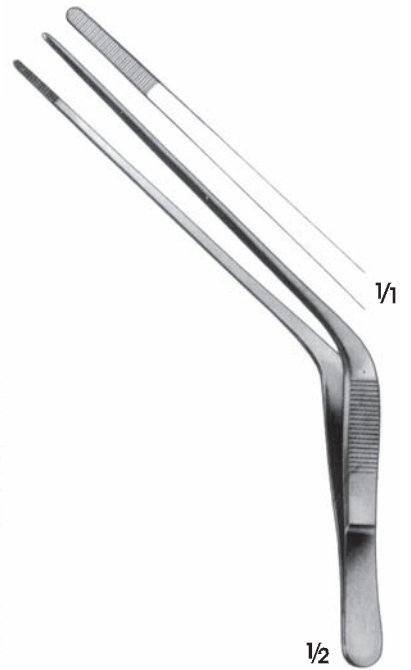

$\frac{1}{2}$
TROELTSCH
D 156.03
17 cm



$\frac{1}{2}$
WILDE
D 157.00
11.5 cm



$\frac{1}{2}$
TROELTSCH
D 158.00
12 cm



$\frac{1}{2}$
TROELTSCH
D 159.00
11.5 cm



LUCAE
D 147.00
14 cm

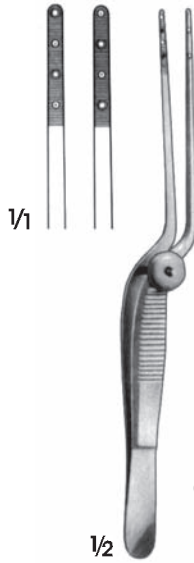

COTTLE
D 150.00
14 cm

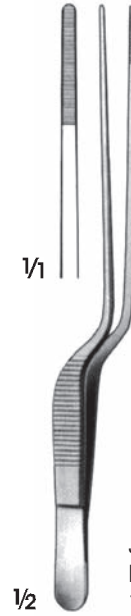

JANSEN
D 148.00
16 cm

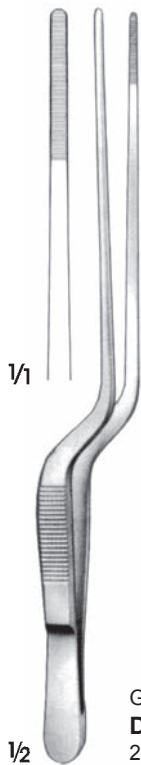

GRUENWALD
D 149.00
20 cm

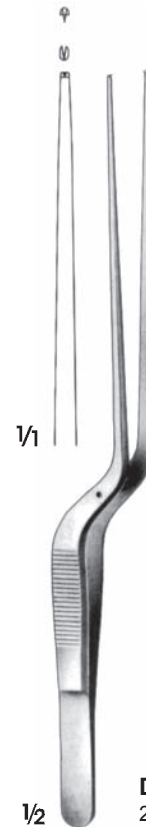

D 154.00
20 cm



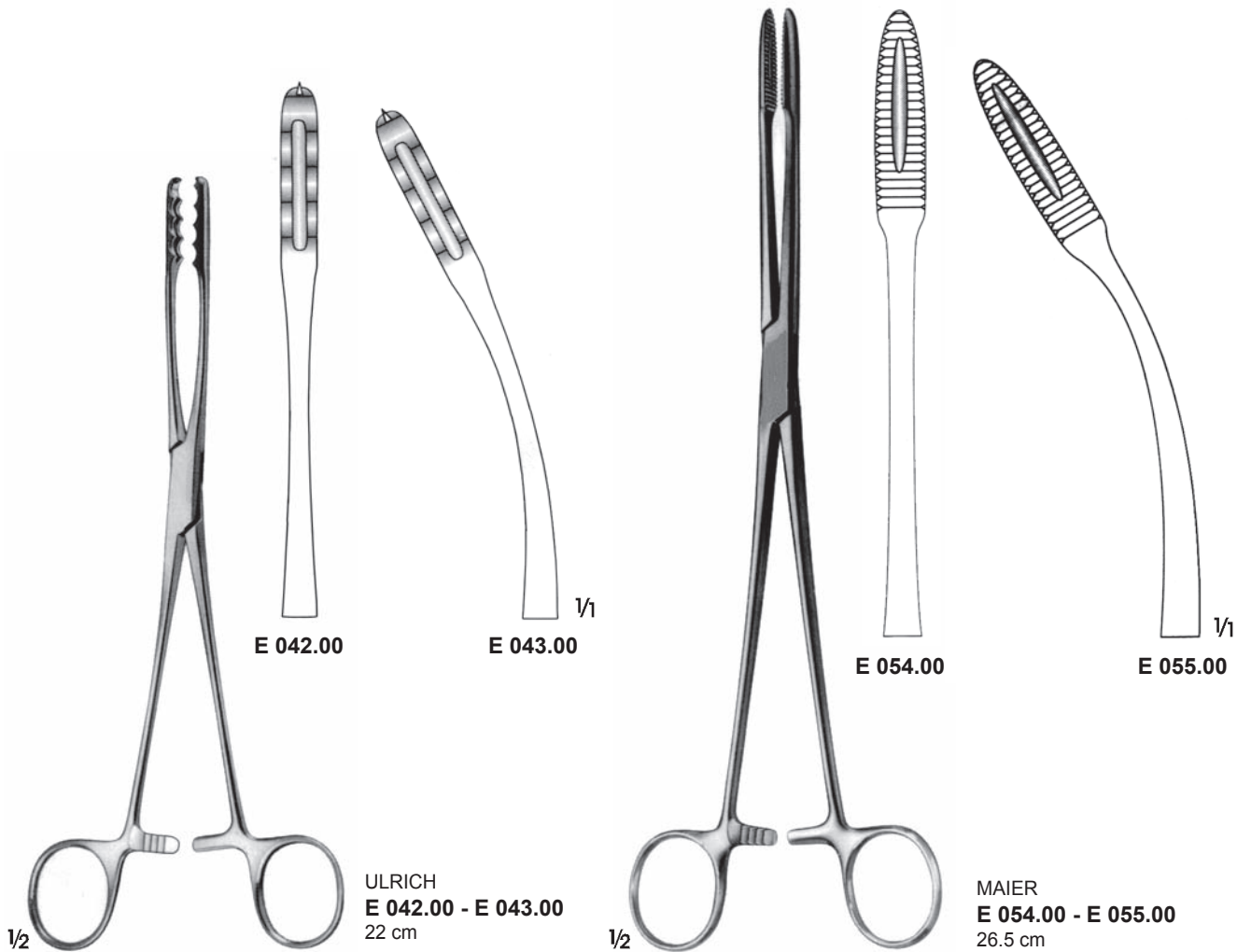

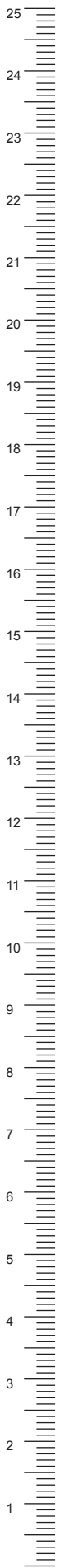

1/2

BOYS-ALLIS
E 143.00
5 X 6 Diş/5 X 6 Teeth
15.5 cm

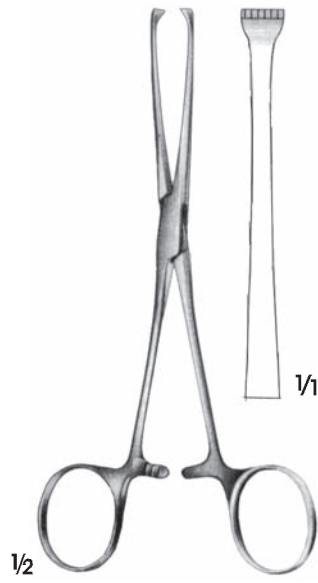

1/2

ALLIS
E 144.00
5 X 6 Diş/5 X 6 Teeth
15.5 cm



1/2

ALLIS
E 145.00
4 X 5 Diş/4 X 5 Teeth
15.5 cm



1/2

LAHEY
E 201.00
15.5 cm



1/2

BRAUN
E 202.00
15.5 cm



1/2

CZERNY
E 206.00
20 cm



JAGER
E 330.00
Esnek şaft/Flexible shaft
27.5 cm

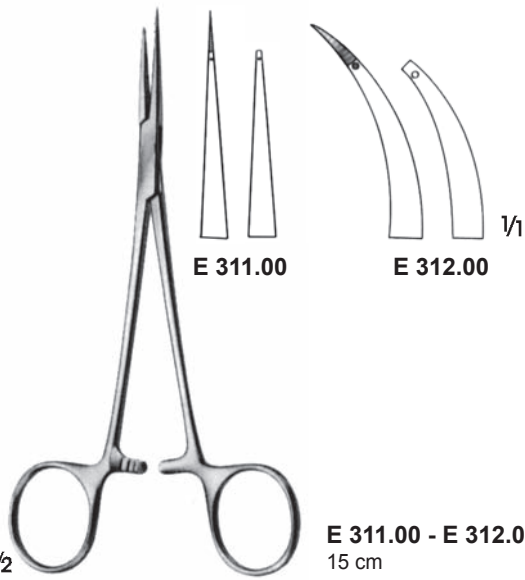

E 311.00

E 312.00

E 311.00 - E 312.00
15 cm

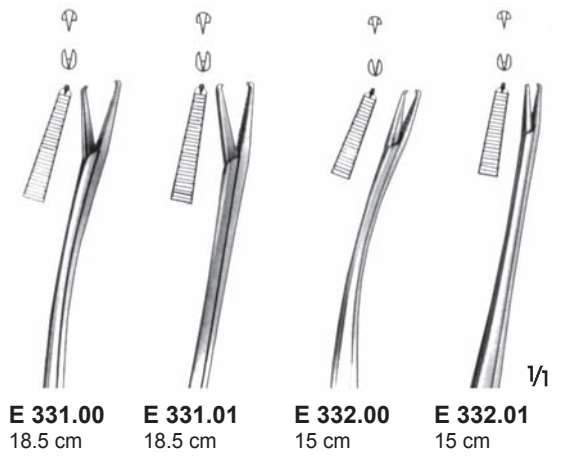

E 331.00
18.5 cm

E 331.01
18.5 cm

E 332.00
15 cm

E 332.01
15 cm



E 302.00

E 302.01

HERZ
E 302.00 - E 302.01
15.5 cm

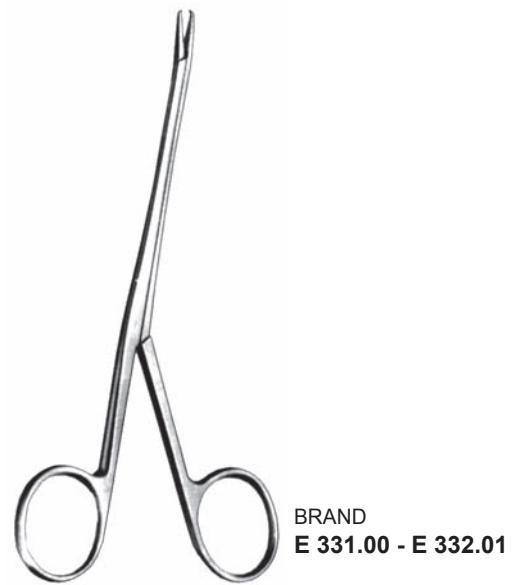

BRAND
E 331.00 - E 332.01

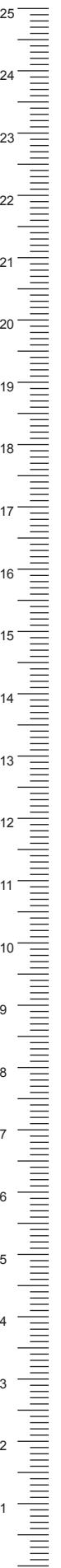
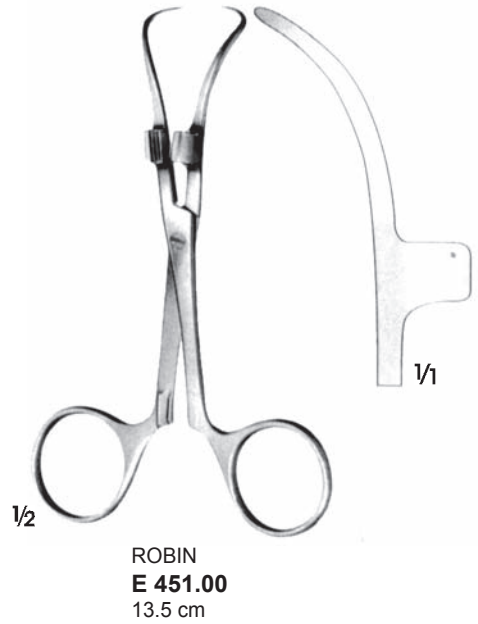
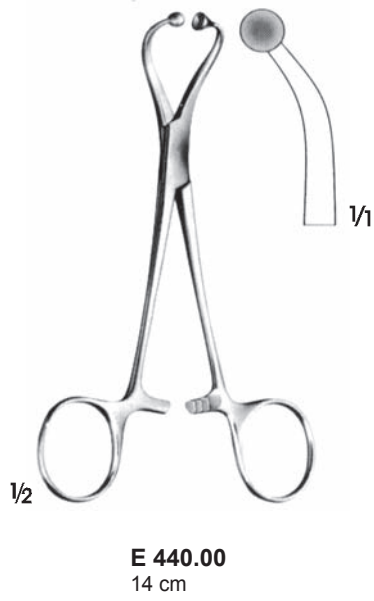
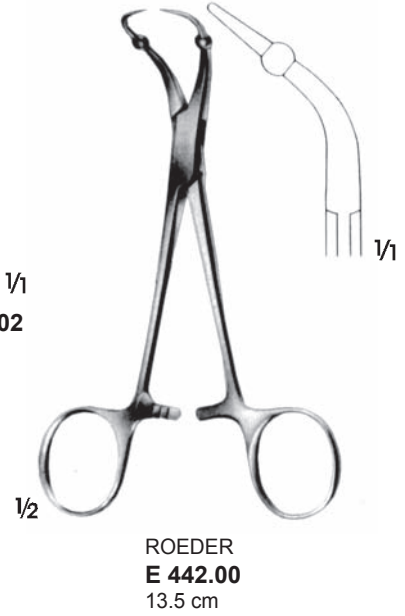
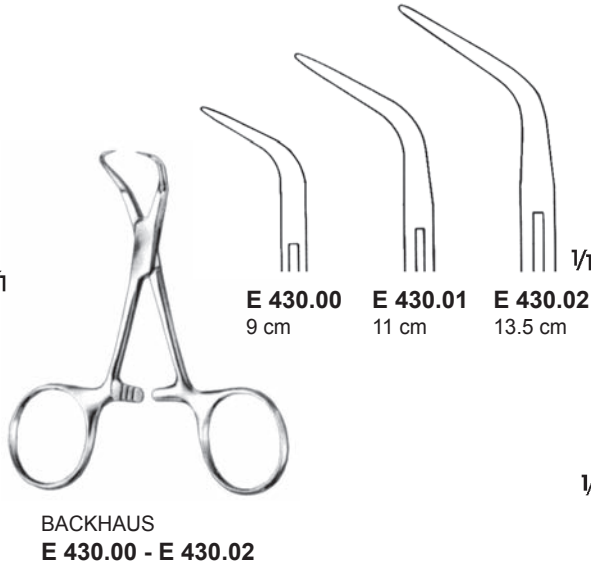

F 130.00 11.5 cm **F 131.00** 13.5 cm

F 110.00 **F 111.00** 1/1

F 112.00 **F 113.00** 1/1

F 116.00 Kilitsiz/Without catch **F 117.00** Kilitli/With catch 1/1

1/2
BARRAQUER
F 130.00 - F 131.00
Kilitsiz/Without catch

1/2
CASTROVIEJO
F 110.00 - F 111.00
Kilitli/With catch
14.5 cm

1/2
F 112.00 - F 113.00
Kilitsiz/Without catch
16 cm

1/2
JACOBSON
F 116.00 - F 117.00
18.5 cm

F 120.00 **F 121.00** 1/1

F 122.00 **F 123.00** 1/1

F 124.00 **F 125.00** 1/1

F 126.00 **F 127.00** 1/1

1/2
BARRAQUER
F 120.00 - F 121.00
Kilitli/With catch
12 cm

1/2
BARRAQUER
F 122.00 - F 123.00
Kilitsiz/Without catch
12 cm

1/2
F 124.00 - F 125.00
Kilitli/With catch
15 cm

1/2
BARRAQUER
F 126.00 - F 127.00
Kilitsiz/Without catch
15 cm



$\frac{1}{2}$
HALSEY
F 203.00 - F 204.00
13 cm



$\frac{1}{2}$
DERF
F 206.00
12.5 cm



$\frac{1}{2}$
BAUMGARTNER
F 210.00
14.5 cm



$\frac{1}{2}$
CRILE-WOOD
F 215.00
15 cm



$\frac{1}{2}$
CRILE-MURKAY
F 219.00
15 cm



$\frac{1}{2}$
HEANEY (HEGAR)
F 236.00
20 cm

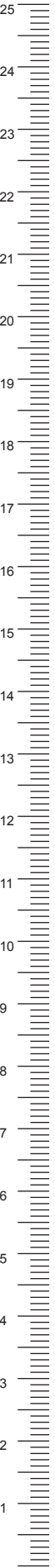

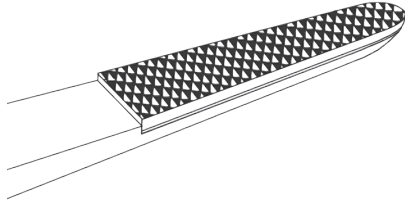

Elmas Uclu Portegüler :

Bahadır Portegülerinin ağızlarındaki elmas uçlarının kullanıma göre yüzey yapısı seçilebilir. Bahadır elmas uclu portegülerinin 4 farklı yüzeyi vardır. Pürüzsüz yüzey ve

3 farklı çentik yüzeyi uygun iğne yakalamayı sağlar.

Needle holders with carbide inserts.

The carbide inserts on BAHADIR needle holders can be selected based on usage. BAHADIR needle holders with carbide inserts have four different surface types. Smooth surface and three different notched surfaces provide appropriate needle catch.



Düz
smooth

Pürüzsüz yüzeye sahip ağızda kullanılacak, dikiş malzemesi için: 9/0 - 11/0

With smooth jaw surface for suture materials: 9/0 - 11/0



0,2

0.2 mm adımlı çentiğe sahip ağızda kullanılacak, dikiş malzemesi için: 6/0 - 10/0

With 0.2 mm pitch of serration for suture material: 6/0 - 10/0



0,4

0.4 mm adımlı çentiğe sahip ağızda kullanılacak, dikiş malzemesi için: 4/0 - 6/0

0.4 mm pitch of serration for suture material: 4/0 - 6/0



0,5

0.5 mm adımlı çentiğe sahip ağızda kullanılacak, dikiş malzemesi için: 3/0' a kadar

0.5 mm pitch of serration for suture material: up to 3/0

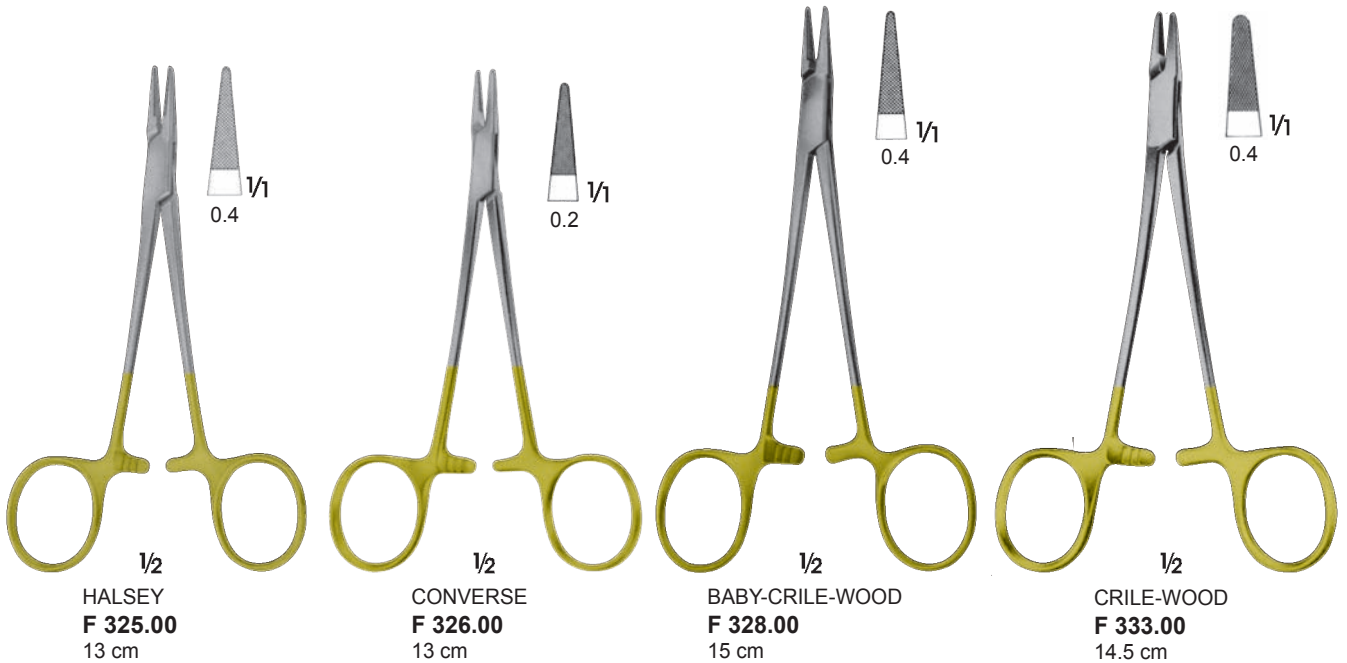



BAUMGARTNER
F 332.00
 14.5 cm

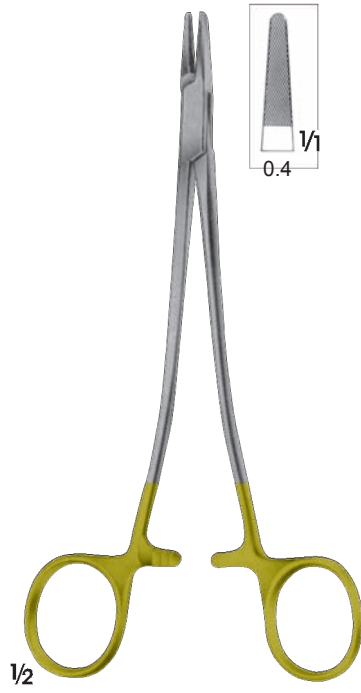

SAROT
F 338.00
 17.5 cm

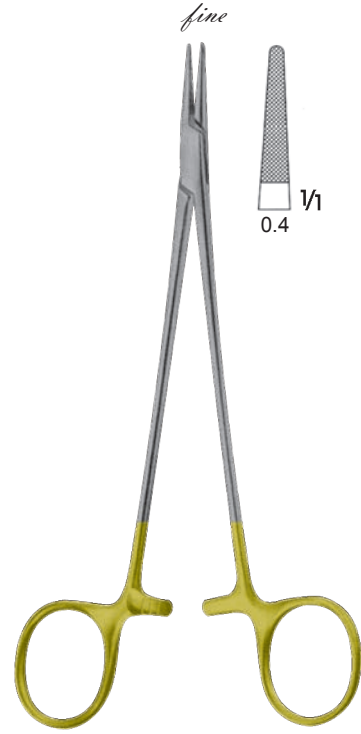

DE BAKEY
F 346.00
 18 cm



F 334.00
 Tel Bükücü/Wire Twister
 15 cm



F 336.00
 Tel Bükücü/Wire Twister
 15 cm

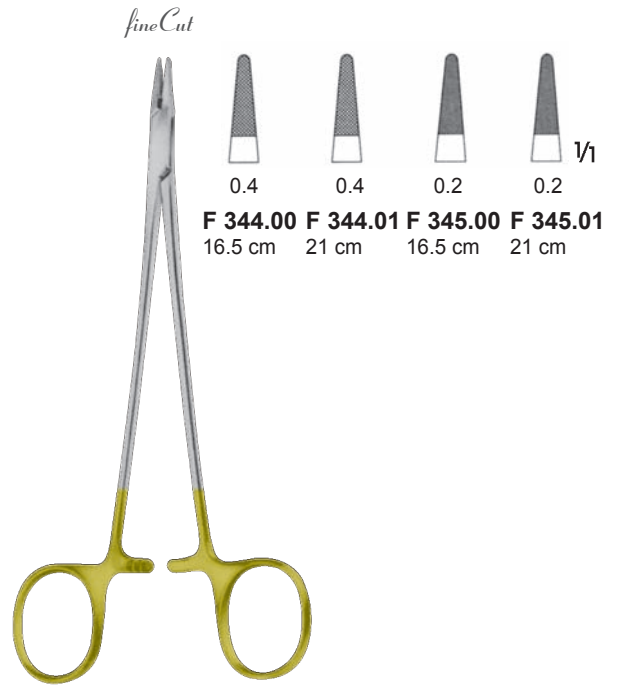

DE BAKEY
F 344.00 - F 345.01
 Çok Hassas/Very Delicate

F 344.00 16.5 cm
F 344.01 21 cm
F 345.00 16.5 cm
F 345.01 21 cm



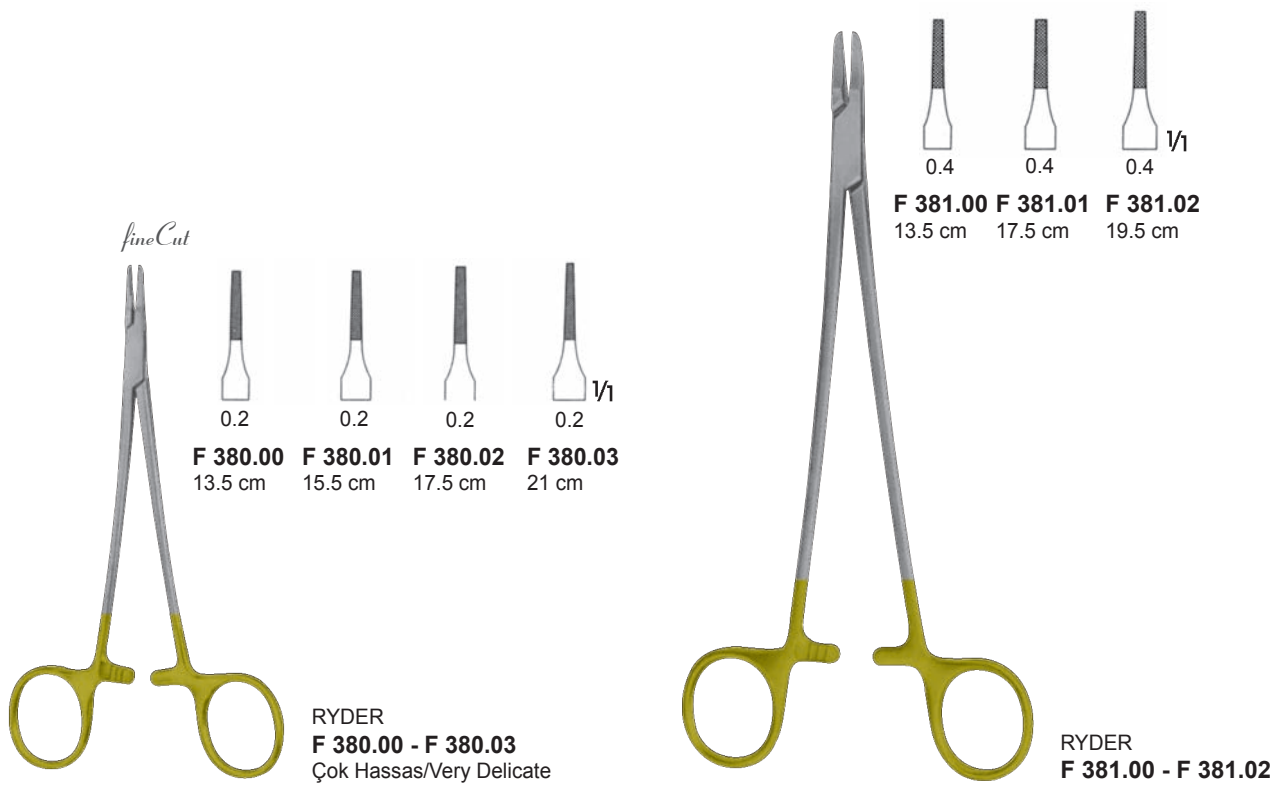
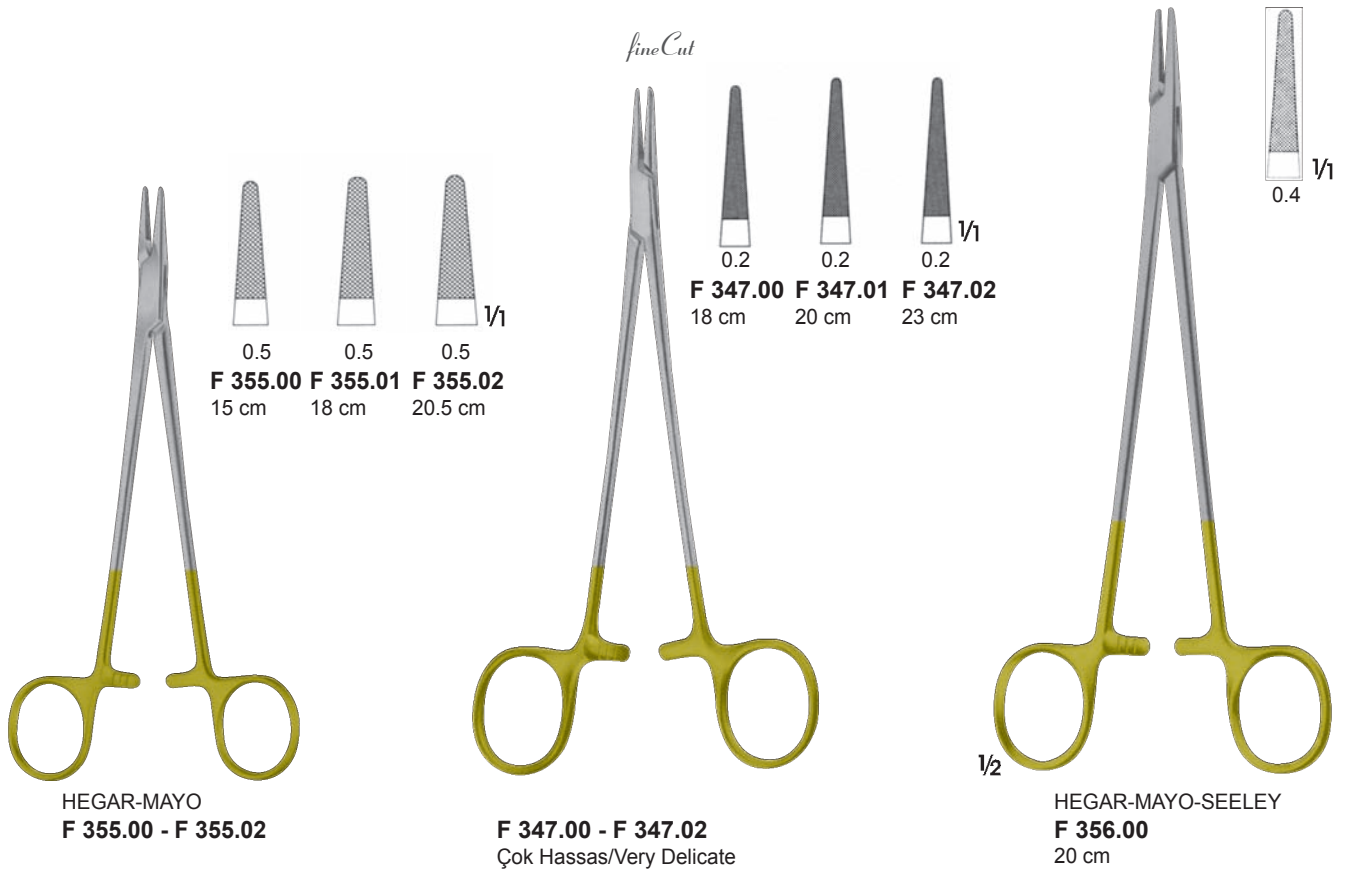

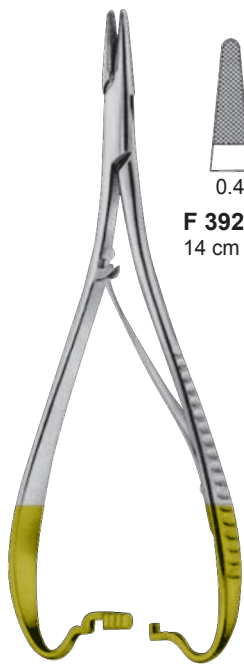

F 392.00 14 cm
F 392.01 17 cm
F 392.02 20 cm

MATHIEU-STANDART
F 392.00 - F 392.02



F 396.00
 Elastik Model/Elastic Pattern
 19.5 cm

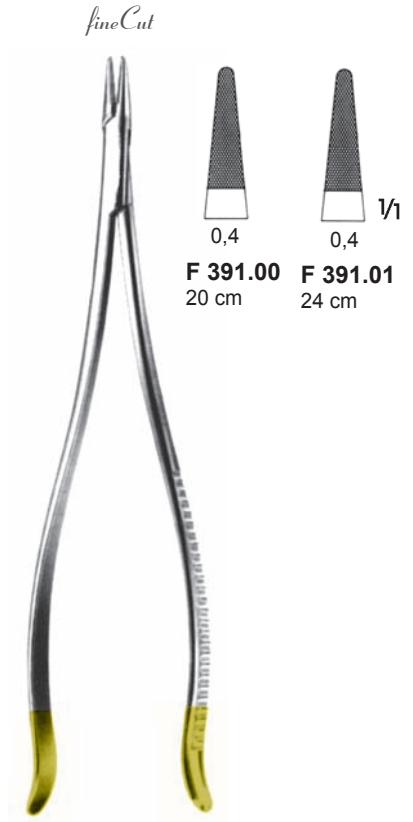

LAHGENBECK
F 391.00 - F 391.01

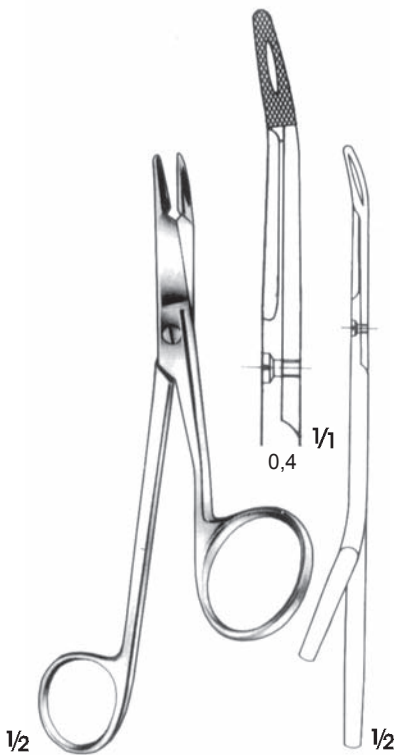

GILLIES
F 269.00
 16 cm

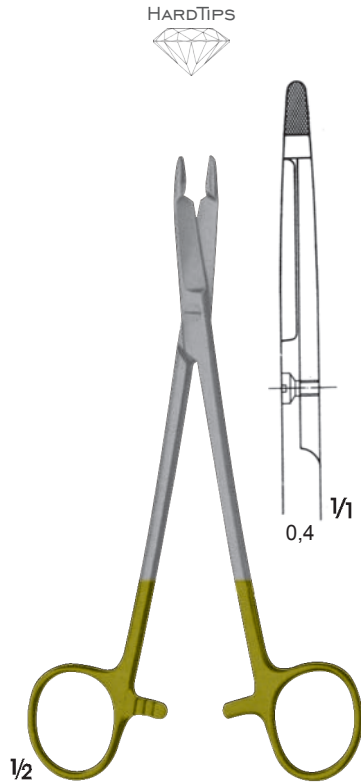

HEGAR-OLSEN
F 343.01
 16.5 cm

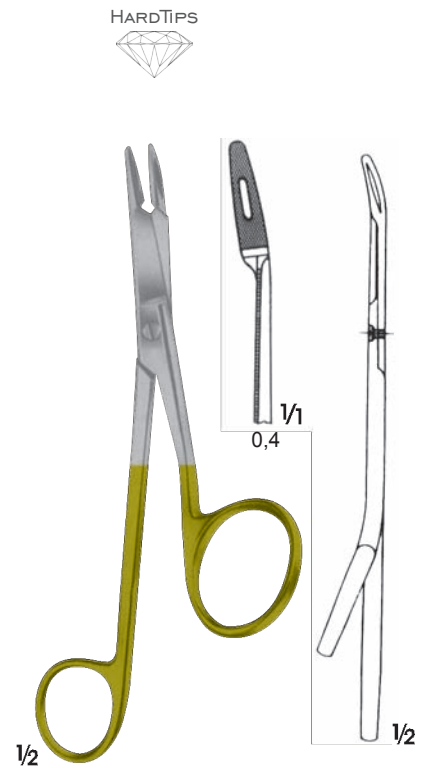

GILLIES
F 342.00
 Tırtilli/Serrated
 16 cm

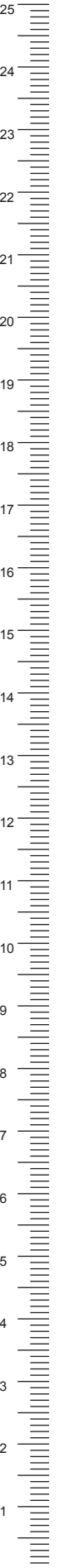



KRONECKER
F 420.00 Sağ/Right
F 421.00 Sol/Left
 Künt/Blunt
 15.5 cm



DESCHAMPS
F 422.00 Sağ/Right
F 423.00 Sol/Left
 Sivri/Sharp
 20.5 cm



HURD
F 424.00 Sağ/Right
F 425.00 Sol/Left
 Sivri/Sharp
 21 cm



DESCHAMPS
F 432.00 Sağ/Right
F 433.00 Sol/Left
 Künt/Blunt
 21.5 cm

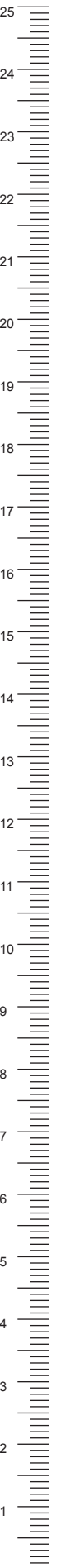
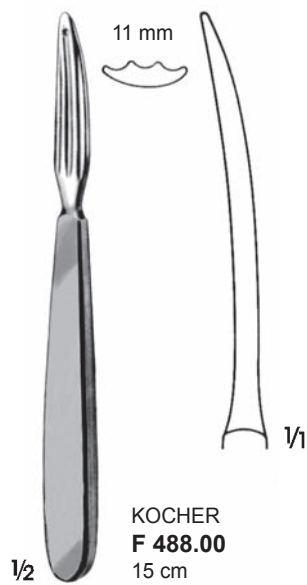
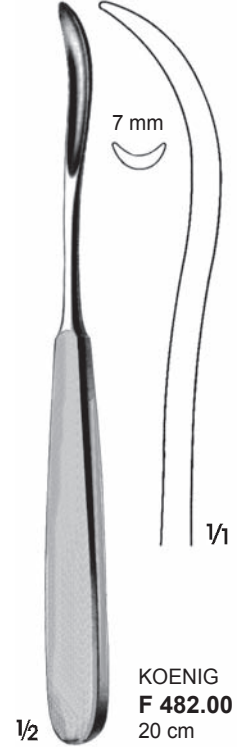
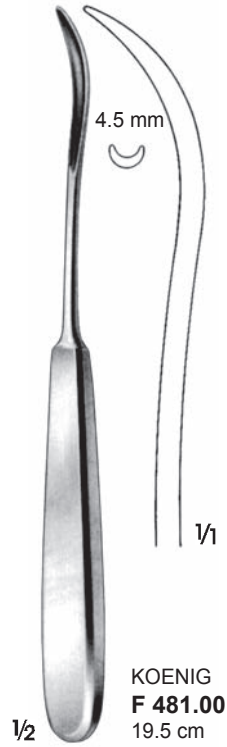
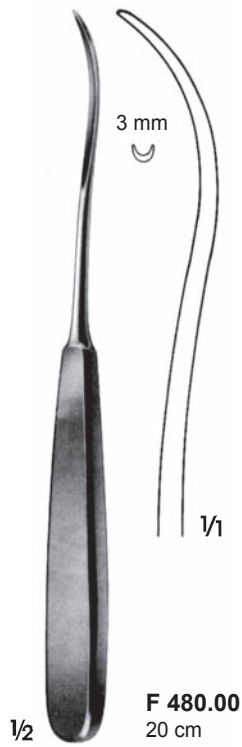

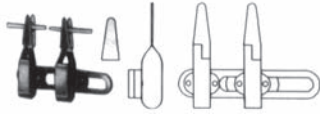

BIEMER-MULLER
S 010.00
Çene uzunluğu/Lenght of jaws.6 mm
Açıklık/Opening 4 mm
Kapanma Kuvveti/Closing force 30-40 gr.



BIEMER-MULLER
S 011.00
Çene uzunluğu/Lenght of jaws.4.5 mm
Açıklık/Opening 3 mm
Kapanma Kuvveti/Closing force 25-30 gr.

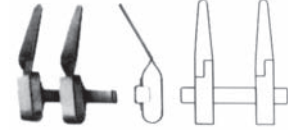

BIEMER-MULLER
S 012.00
Çene uzunluğu/Lenght of jaws.9 mm
Açıklık/Opening 5 mm
Kapanma Kuvveti/Closing force 25-30 gr.

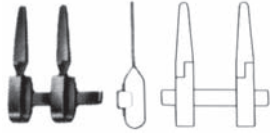

BIEMER-MULLER
S 013.00
Çene uzunluğu/Lenght of jaws.9 mm
Açıklık/Opening 5 mm
Kapanma Kuvveti/Closing force 25-30 gr.



BIEMER-MULLER
S 014.00
Çene uzunluğu/Lenght of jaws.9 mm
Açıklık/Opening 5 mm
Kapanma Kuvveti/Closing force 25-30 gr.

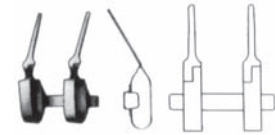

BIEMER-MULLER
S 015.00
Çene uzunluğu/Lenght of jaws.9 mm
Açıklık/Opening 5 mm
Kapanma Kuvveti/Closing force 25-30 gr.

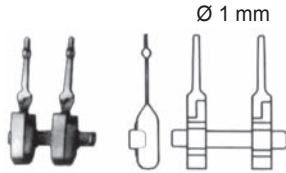

MULLER
S 020.00
Kapanma kuvveti/Closing force. 25-30 gr.

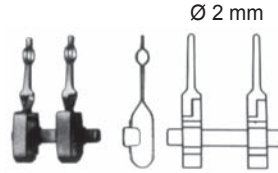

MULLER
S 021.00
Kapanma kuvveti/Closing force. 25-30 gr.

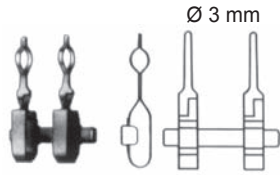

MULLER
S 022.00
Kapanma kuvveti/Closing force. 25-30 gr.

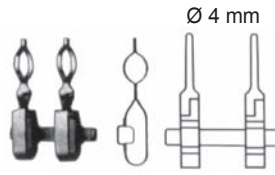

MULLER
S 023.00
Kapanma kuvveti/Closing force. 25-30 gr.



S 030.00
Aproksimatör/Approximator



BIEMER
S 024.00
Aproksimatör/Approximator
1/2 14.5 cm

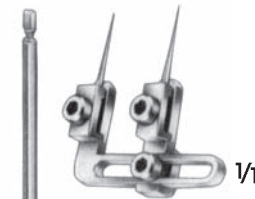

BIEMER
S 026.00
Komple Aproksimatör,
anahtarı ile
S 029.00 Approximator, complete
with key S 029.00



BIEMER
S 025.00
Komple Aproksimatör,
anahtarı ile
S 029.00 Approximator, complete
with key S 029.00

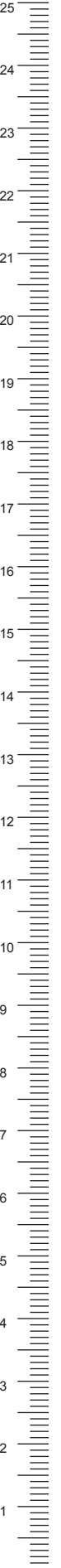
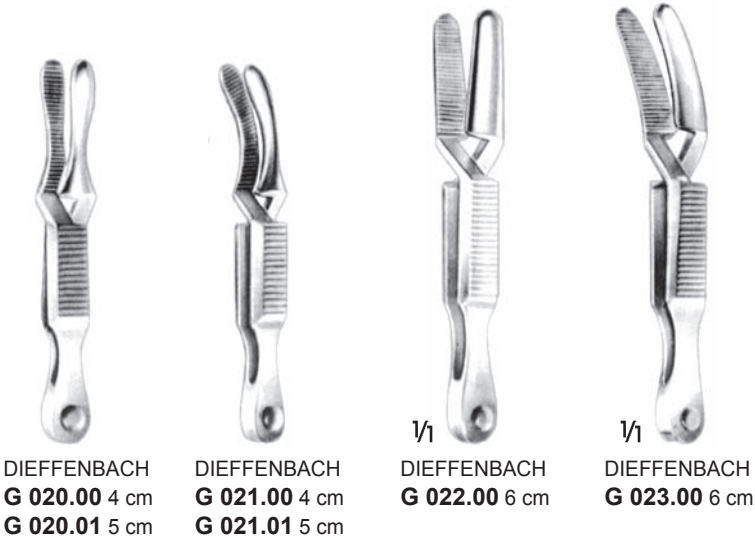
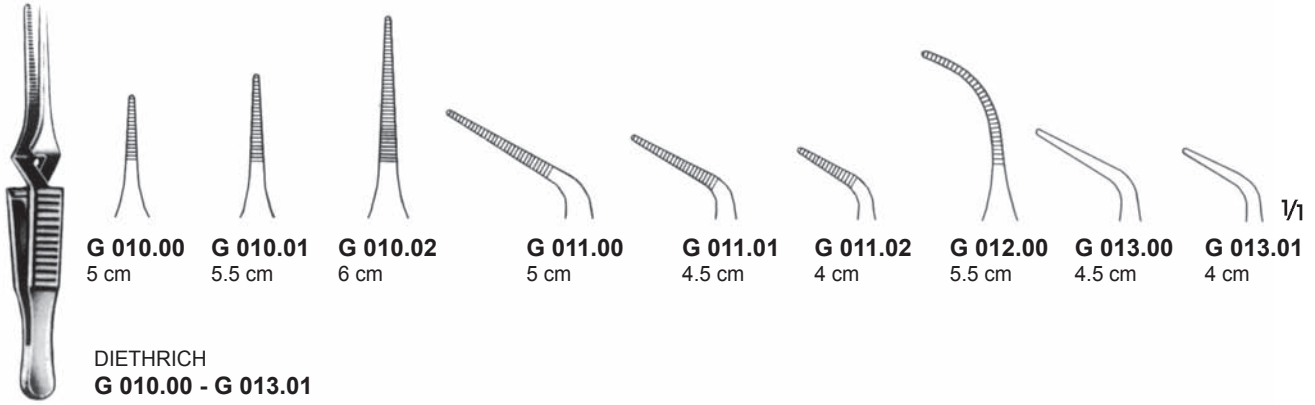

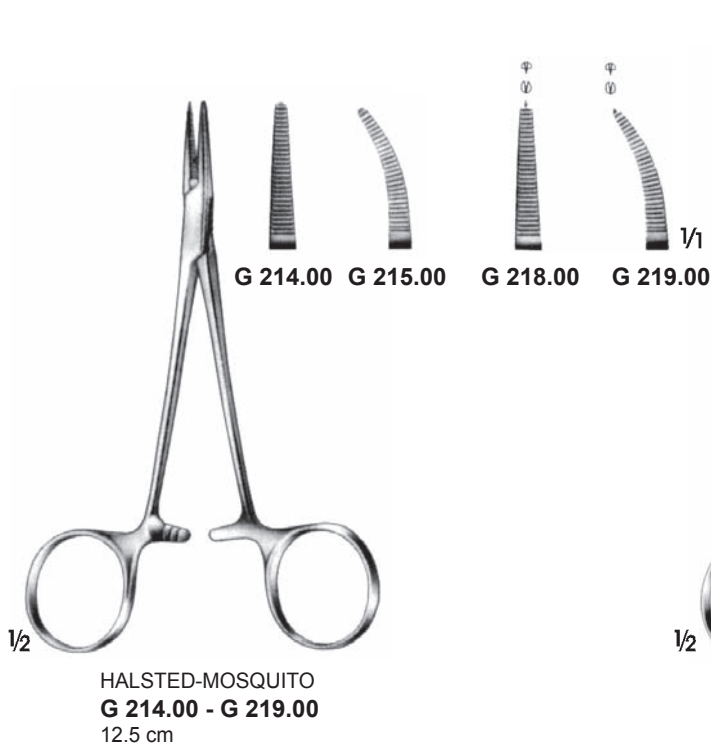
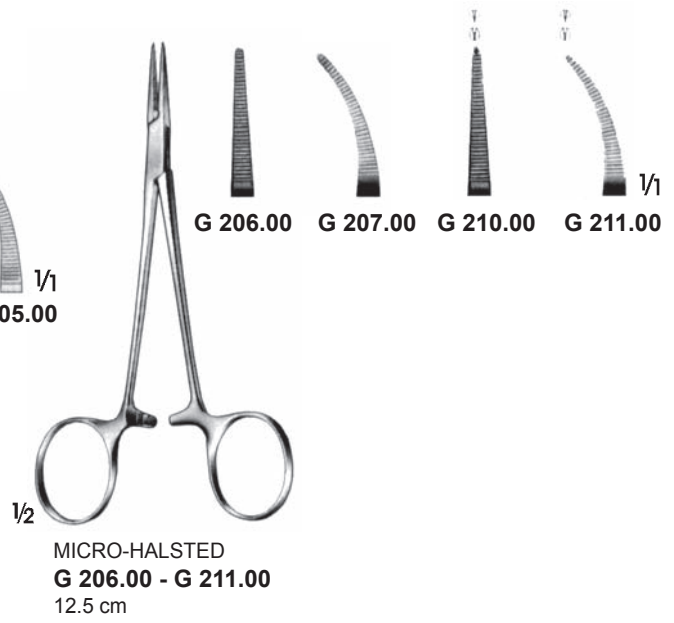
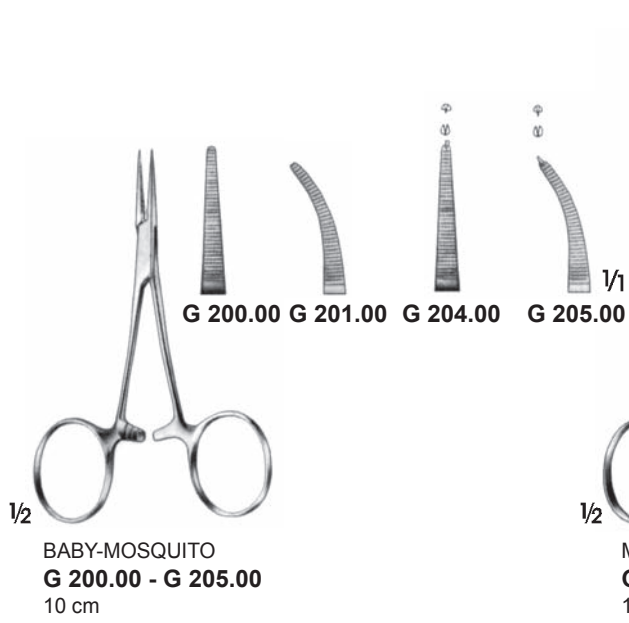

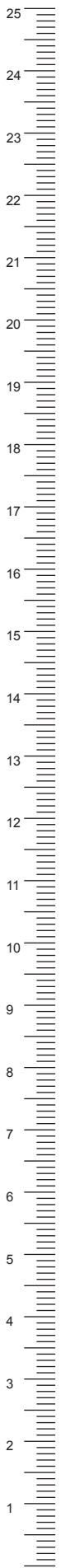

G 230.00 G 231.00

1/2

PROCIDENCE-HOSPITAL
G 230.00 - G 231.00
14 cm

G 234.00 G 235.00

1/2

KELLY
G 234.00 - G 235.00
14 cm

G 278.00 G 279.00

1/2

ADSON
G 278.00 - G 279.00
18.5 cm

G 240.00 G 241.00

G 244.00 G 245.00

1/2

CRILE
G 240.00 - G 245.00
14 cm

G 250.00 G 251.00

G 254.00 G 255.00

1/2

LERICHE
G 250.00 - G 255.00
15 cm

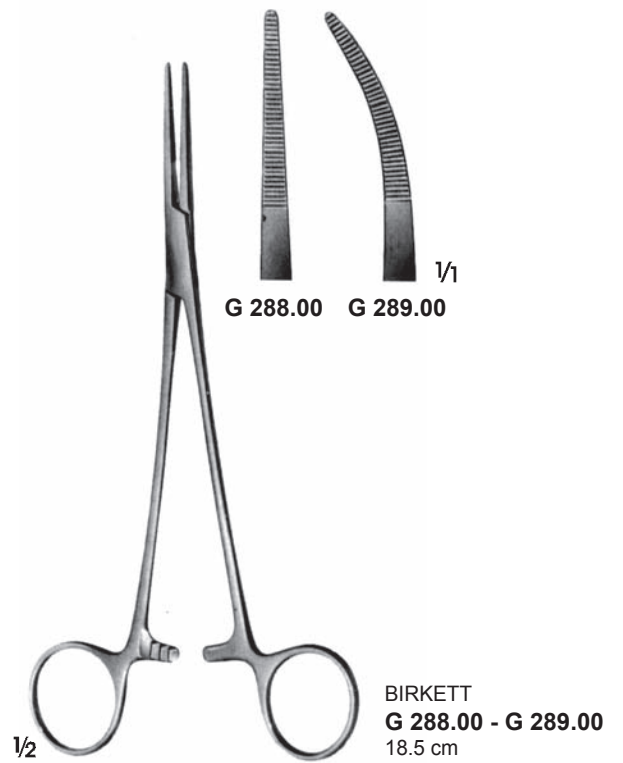
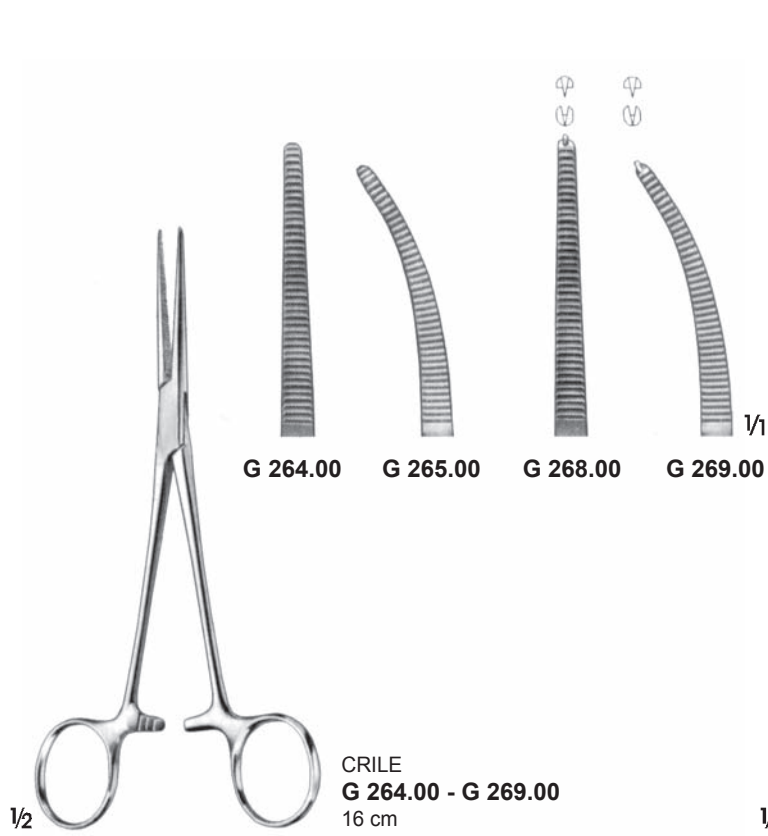

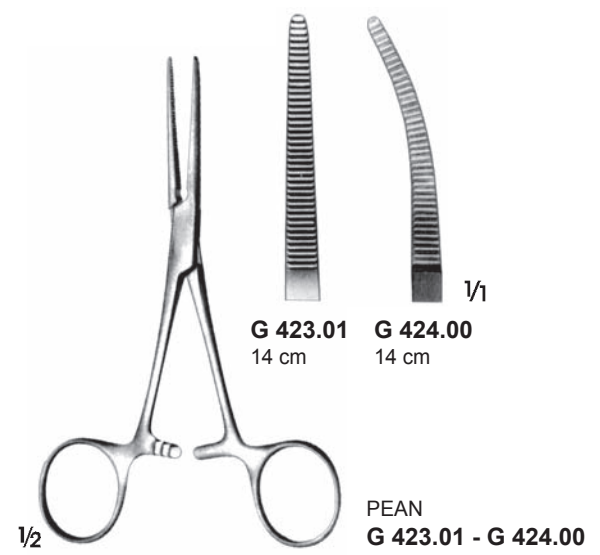
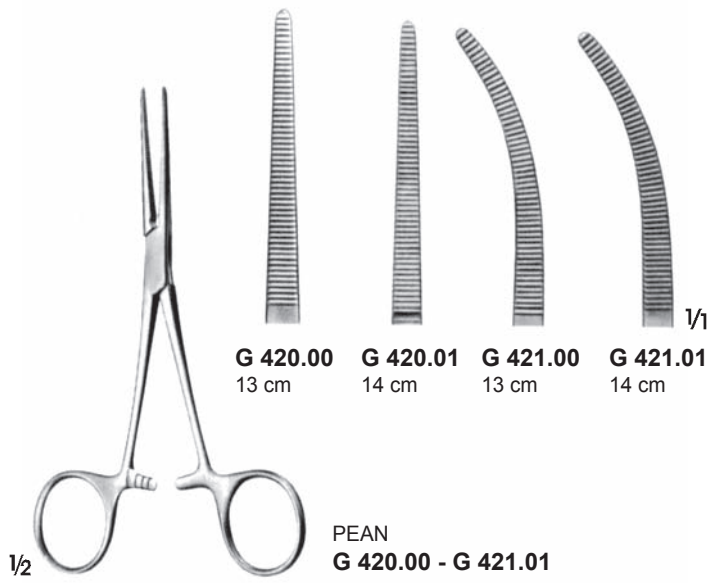
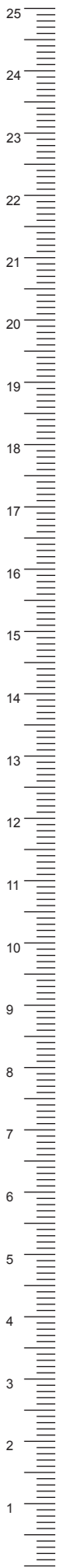

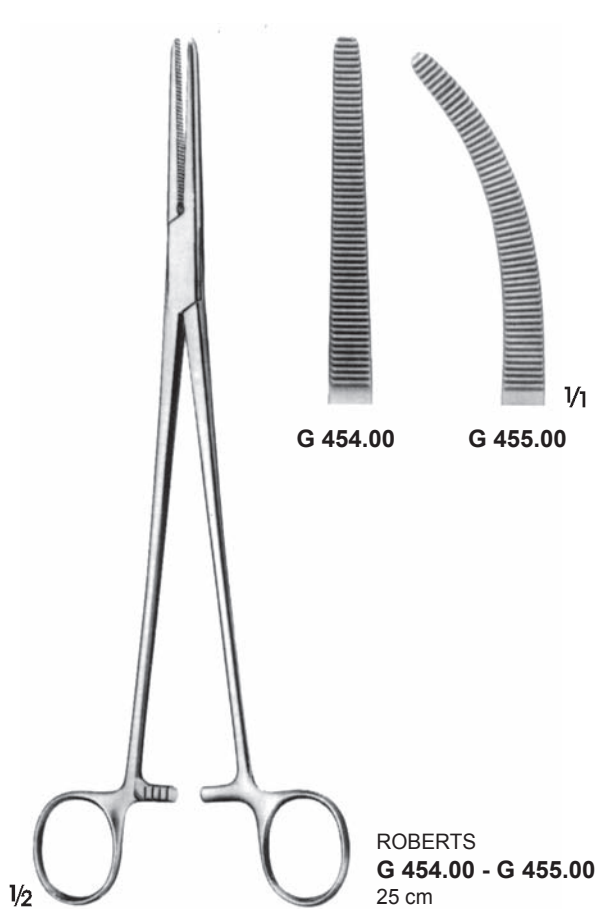
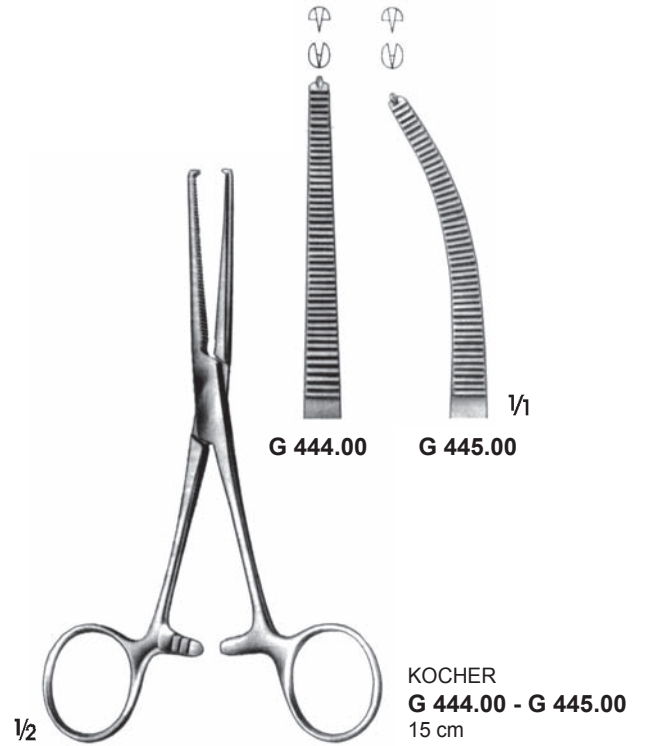
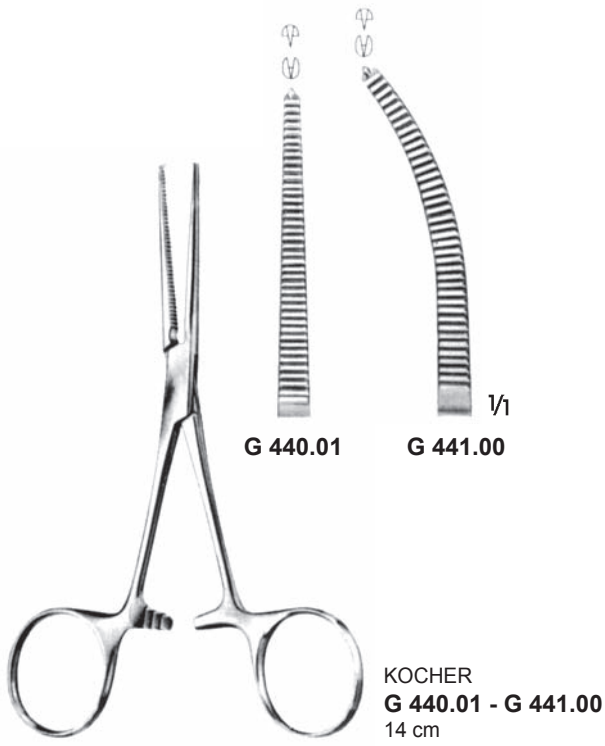



MICRO-ADSON
G 614.00
14 cm



BABY-OVERHOLT
G 615.00
13.5 cm



G 616.00 14 cm
G 616.01 18 cm

BABY-MIXTER
G 616.00 - G 616.01



BABY-ADSON
G 617.00
14 cm



G 618.00 18.5 cm
G 618.01 21 cm
G 618.02 21.5 cm
G 618.03 22 cm

G 618.00 - G 618.03



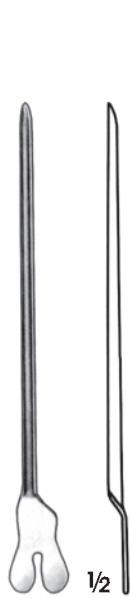

J 010.00 13 cm
J 010.01 14.5 cm
J 010.02 16 cm



J 015.00
14 cm



J 030.00 13 cm
J 030.01 14.5 cm
J 030.02 16 cm
J 030.03 18 cm
J 030.04 20 cm



BOWMAN
J 049.00 Ø 0.7 + 0.8 mm
J 049.01 Ø 0.9 + 1.1 mm
J 049.02 Ø 1.3 + 1.4 mm
J 049.03 Ø 1.5 + 1.6 mm
J 049.04 Ø 1.8 + 1.9 mm
Bükülebilir/Malleable
13 cm



J 043.00
16 cm



SEIFFERT
J 045.00
Bükülebilir/Malleable
18 cm



KILLIAN
J 047.00
16.5 cm



RITTER
J 026.01 Ø 2.5 mm
J 026.02 Ø 3.0 mm
J 026.03 Ø 4.0 mm
J 026.04 Ø 5.0 mm
16 cm

Ø 0.8 mm



1/2

STACKE
J 042.00Bükülebilir/Malleable
10 cmUc çapı
Diameter of tips

1 mm	1.5 mm	2 mm	Uzunluk Length
-	J 033.07	-	13 cm
J 033.01	J 033.08	J 033.15	14.5 cm
-	J 033.09	J 033.16	16 cm
-	J 033.10	J 033.17	18 cm
-	J 033.11	J 033.18	20 cm
-	J 033.12	-	25 cm
-	-	J 033.20	30 cm

J 033.01 - J 033.20

J 035.00 Ø 2 mm
J 035.01 Ø 2.5 mm
J 035.02 Ø 3.0 mm



J 035.00 14.5 cm
J 035.01 16 cm
J 035.02 20 cm

Ø 3.5 mm



J 038.00 25 cm
J 038.01 30 cm
Bükülebilir/Malleable

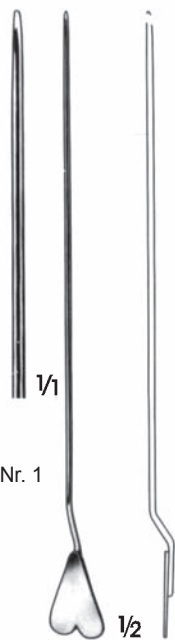

Nr. 1

1/2

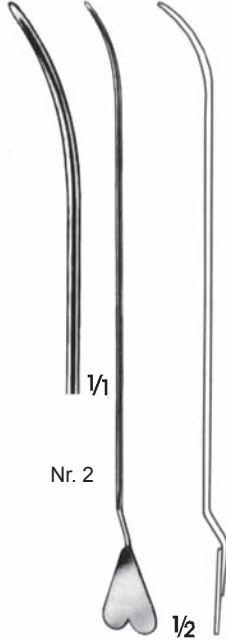

Nr. 2

1/2

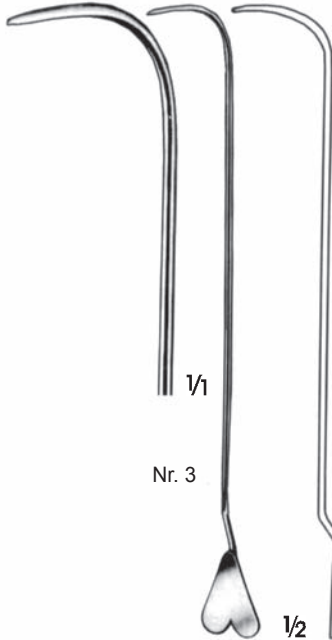

Nr. 3

1/2

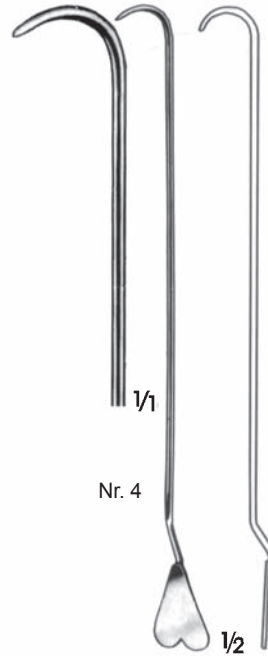

Nr. 4

1/2

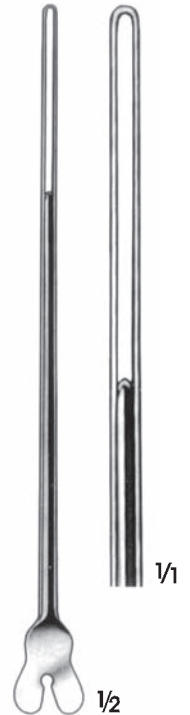

1/1

1/2

LOCKHART-MUMMERY

J 020.00 Nr. 1. Düz/Straight

J 020.01 Nr. 2. 45° Eğri/Curved

J 020.02 Nr. 3. 90° Eğri/Curved

J 020.03 Nr. 4. Eğri/Curved

16.5 cm

J 024.00

Bükülebilir/Malleable
19 cm

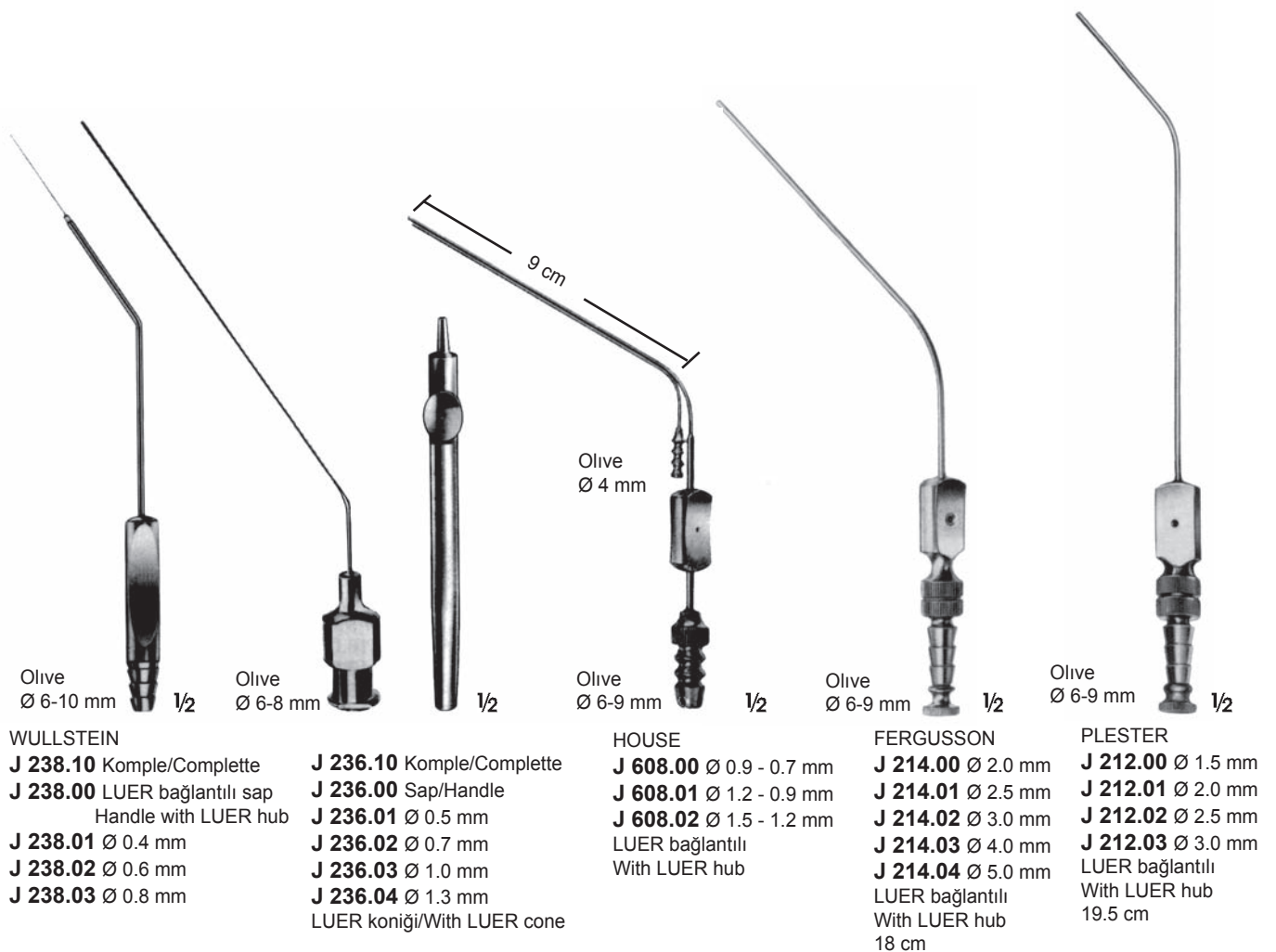
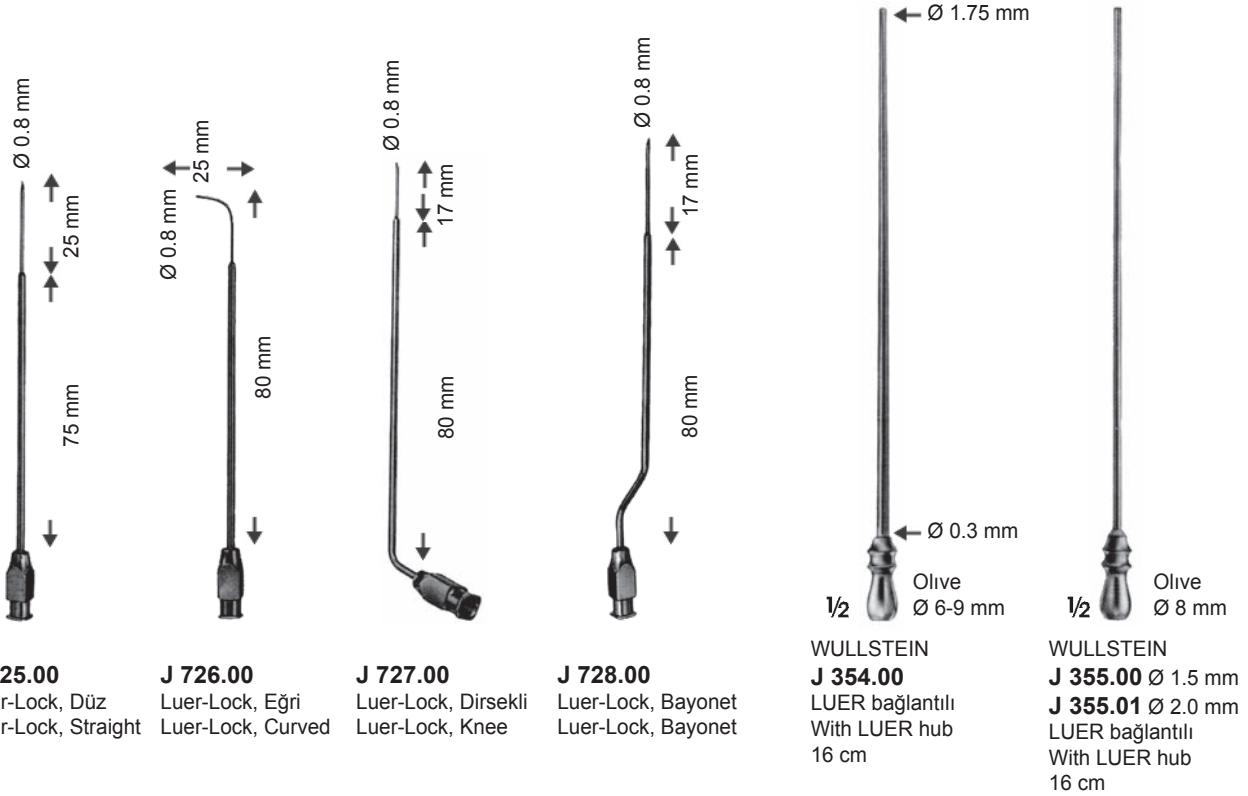



BARON
J 234.00 Ø 1.5 mm
7.5 cm



BARON
J 234.01 Ø 2.0 mm
7.5 cm



BARON
J 234.02 Ø 1.0 mm
7.5 cm



1/1
SCHUKNECHT
J 370.00 Ø 1 mm
J 370.01 Ø 1.5 mm
J 370.02 Ø 2 mm
J 370.03 Ø 3 mm
13 cm

Ø 5.0 mm



J 352.00
Uc genişliği 6.5 mm
Tip wide 6.5 mm
LUER bağlantılı
With LUER hub
18 cm



J 230.00
LUER
RECORD



J 231.00
RECORD
LUER-LOCK

Olive
Ø 6-9 mm

1/2



Olive
Ø 6-9 mm

1/2

FERGUSSON
J 220.02 Ø 4 mm
İzoleli/Insulated
LUER bağlantılı
With LUER hub
18 cm



Olive
Ø 6-9 mm

1/2

FRAZIER
J 222.00 Ø 3 mm
J 222.01 Ø 5 mm
LUER bağlantılı
With LUER hub
18 cm

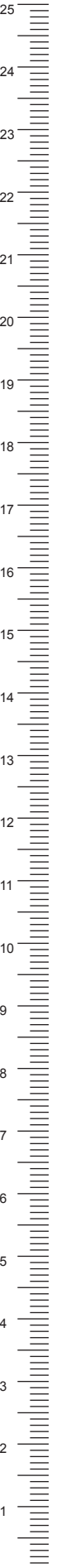

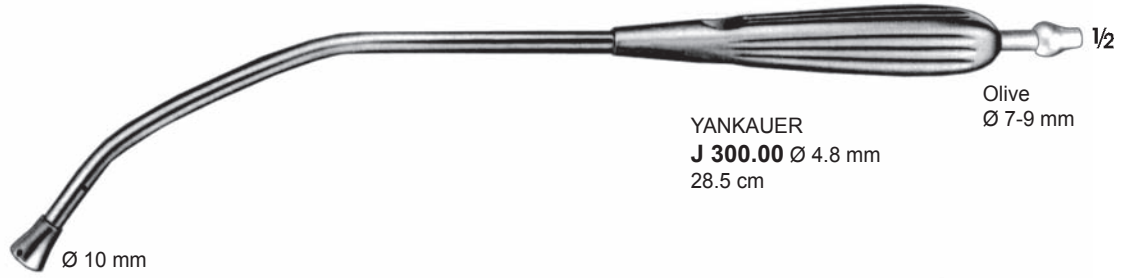

YASARGIL

J 260.00 Ø 1.5 mm	J 260.01 Ø 1.5 mm	J 260.02 Ø 1.5 mm	J 260.03 Ø 1.5 mm
J 260.04 Ø 2.0 mm	J 260.05 Ø 2.0 mm	J 260.06 Ø 2.0 mm	J 260.07 Ø 2.0 mm
J 260.08 Ø 2.5 mm	J 260.09 Ø 2.5 mm	J 260.10 Ø 2.5 mm	J 260.11 Ø 2.5 mm
J 260.12 Ø 3.5 mm 13 cm	J 260.13 Ø 3.5 mm 15 cm	J 260.14 Ø 3.5 mm 18 cm	J 260.15 Ø 3.5 mm 22 cm

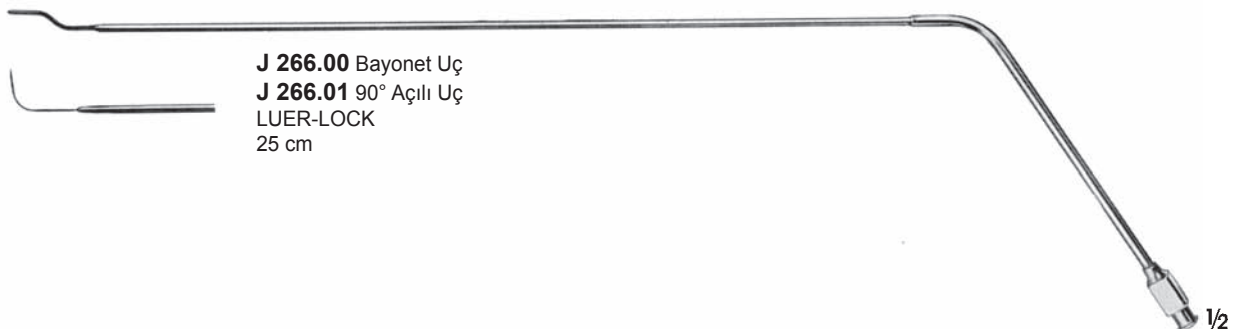
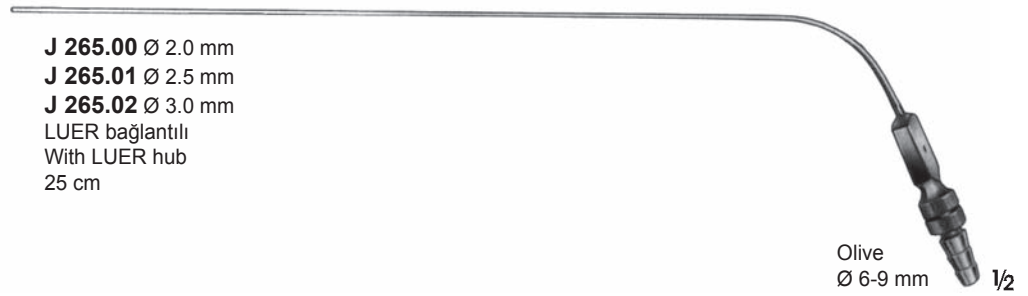
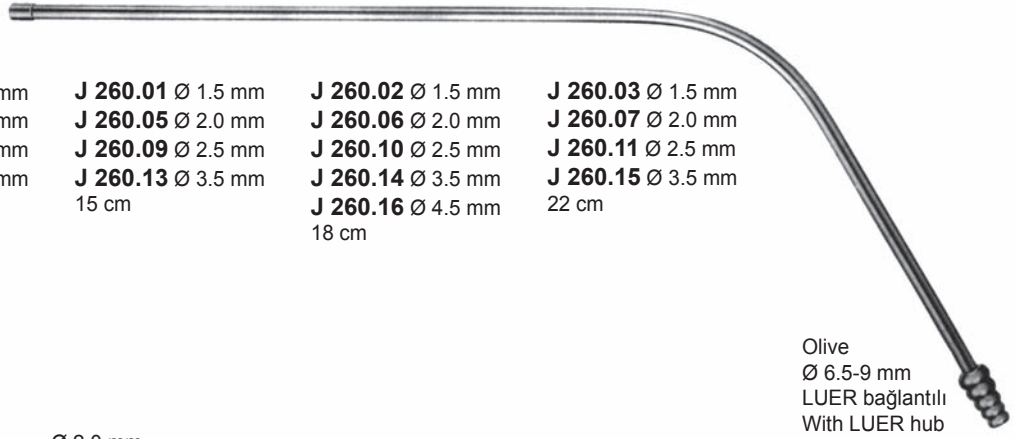



$\frac{1}{2}$
J 350.00 Ø 4.5 mm
J 350.01 Ø 5.5 mm
17.5 cm



$\frac{1}{2}$
SIEBENMANN
J 314.01 Ø 2.5 mm
J 314.02 Ø 3.0 mm
Künt/Blunt
13 cm



$\frac{1}{2}$
J 317.01



$\frac{1}{2}$
BELLOCQ
J 318.00 Ø 2.5 mm
13 cm



$\frac{1}{2}$
EICKEN
J 325.01 Ø 2.5 mm
J 325.02 Ø 3.0 mm
LUER bağlantılı
LUER attachment
13 cm



$\frac{1}{2}$
LICHTWITZ-BIER
J 340.01 Ø 1.5 mm
J 340.02 Ø 1.8 mm
J 340.03 Ø 2.0 mm
LUER bağlantılı
LUER attachment
10 cm



$\frac{1}{2}$
EICKEN
J 341.01 Ø 1.5 mm
J 341.02 Ø 1.8 mm
J 341.03 Ø 2.0 mm
J 341.04 Ø 2.5 mm
LUER bağlantılı
LUER attachment
10 cm



$\frac{1}{2}$
GORNEY
J 368.00
18 cm



Olive
Ø 6-10 mm
 $\frac{1}{2}$

J 360.00 4 mm
J 360.01 5 mm
Sivri/Sharp
20 cm



$\frac{1}{2}$
LANDOLT
J 361.00 3.2 mm
Sivri/Sharp
20 cm

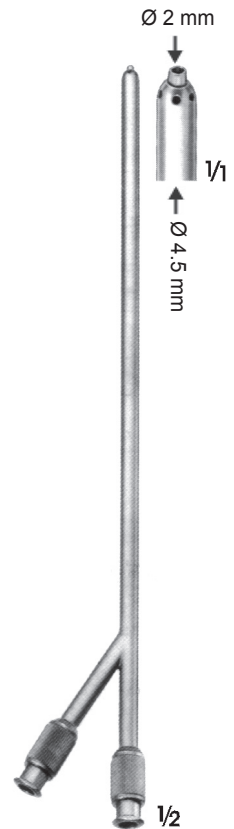

$\frac{1}{2}$
YASARGIL
J 602.00
LUER-LOCK koniği
LUER-LOCK cone
20 cm





J 116.00 Ø 5 mm
8.5 cm



J 117.00 Ø 5 mm
8.5 cm



Rekord koniği
With Record cone

1/2
PIERCE
J 108.00 Ø 4.0 mm



Rekord koniği
With Record cone

1/2
KRAUSE
J 110.00 Ø 4.0 mm



1/2
TILLEY LICHTWITZ
J 113.01 Ø 1.7 mm
J 113.02 Ø 2.0 mm
20 cm









1/2
TILLEY LICHTWITZ
J 114.01 Ø 2.3 mm
J 114.02 Ø 2.7 mm
18.5 cm



LUER-LOCK koniği
LUER-LOCK cone

1/2
COAKLEY
J 126.00 Ø 3 mm
14 cm

-  **J 720.00** Ø 2 mm
LUER-LOCK
4 cm
-  **J 721.00** Ø 2.5 mm
-  **J 721.01** Ø 3.0 mm
LUER-LOCK
10 cm
-  **J 722.00** Ø 2.5 mm
-  **J 722.01** Ø 3.0 mm
LUER-LOCK
10 cm
-  **J 723.00** Ø 2.5 mm
-  **J 723.01** Ø 3.0 mm
LUER-LOCK
10 cm



- ACCELERATOR**
- J 470.00** 2 mm 15 cm
 - J 470.01** 3 mm 15 cm
 - J 470.02** 4 mm 26 cm
 - J 470.03** 5 mm 26 cm
 - J 470.04** 6 mm 36 cm
 - J 470.05** 8 mm 36 cm

- JOHNSON EDGER**
- J 471.00** 2 mm 15 cm
 - J 471.01** 3 mm 15 cm
 - J 471.02** 4 mm 26 cm
 - J 471.03** 5 mm 26 cm
 - J 471.04** 6 mm 36 cm
 - J 471.05** 8 mm 36 cm

- MERCEDES**
- J 472.00** 2 mm 15 cm
 - J 472.01** 3 mm 15 cm
 - J 472.02** 4 mm 26 cm
 - J 472.03** 5 mm 26 cm
 - J 472.04** 6 mm 36 cm
 - J 472.05** 8 mm 36 cm

- ACCELERATOR**
- J 473.00** 2 mm 15 cm
 - J 473.01** 3 mm 15 cm
 - J 473.02** 4 mm 26 cm
 - J 473.03** 5 mm 26 cm
 - J 473.04** 6 mm 36 cm
 - J 473.05** 8 mm 36 cm

- FOURNIER**
- J 474.00** 2 mm 15 cm
 - J 474.01** 3 mm 15 cm
 - J 474.02** 4 mm 26 cm
 - J 474.03** 5 mm 26 cm
 - J 474.04** 6 mm 36 cm
 - J 474.05** 8 mm 45 cm

- LAS VEGAS**
- J 475.00** 2 mm 15 cm
 - J 475.01** 3 mm 15 cm
 - J 475.02** 4 mm 26 cm
 - J 475.03** 5 mm 26 cm
 - J 475.04** 6 mm 36 cm
 - J 475.05** 8 mm 36 cm

- BECKER**
- J 476.00** 2 mm 15 cm
 - J 476.01** 3 mm 15 cm
 - J 476.02** 4 mm 26 cm
 - J 476.03** 5 mm 26 cm
 - J 476.04** 6 mm 36 cm
 - J 476.05** 8 mm 45 cm

- SPATULA**
- J 478.00** 2 mm 15 cm
 - J 478.01** 3 mm 15 cm
 - J 478.02** 4 mm 26 cm
 - J 478.03** 5 mm 26 cm
 - J 478.04** 6 mm 36 cm
 - J 478.05** 8 mm 45 cm

- STANDARD**
- J 469.00** 2 mm 15 cm
 - J 469.01** 3 mm 15 cm
 - J 469.02** 4 mm 26 cm
 - J 469.03** 5 mm 26 cm
 - J 469.04** 6 mm 36 cm
 - J 469.05** 8 mm 36 cm

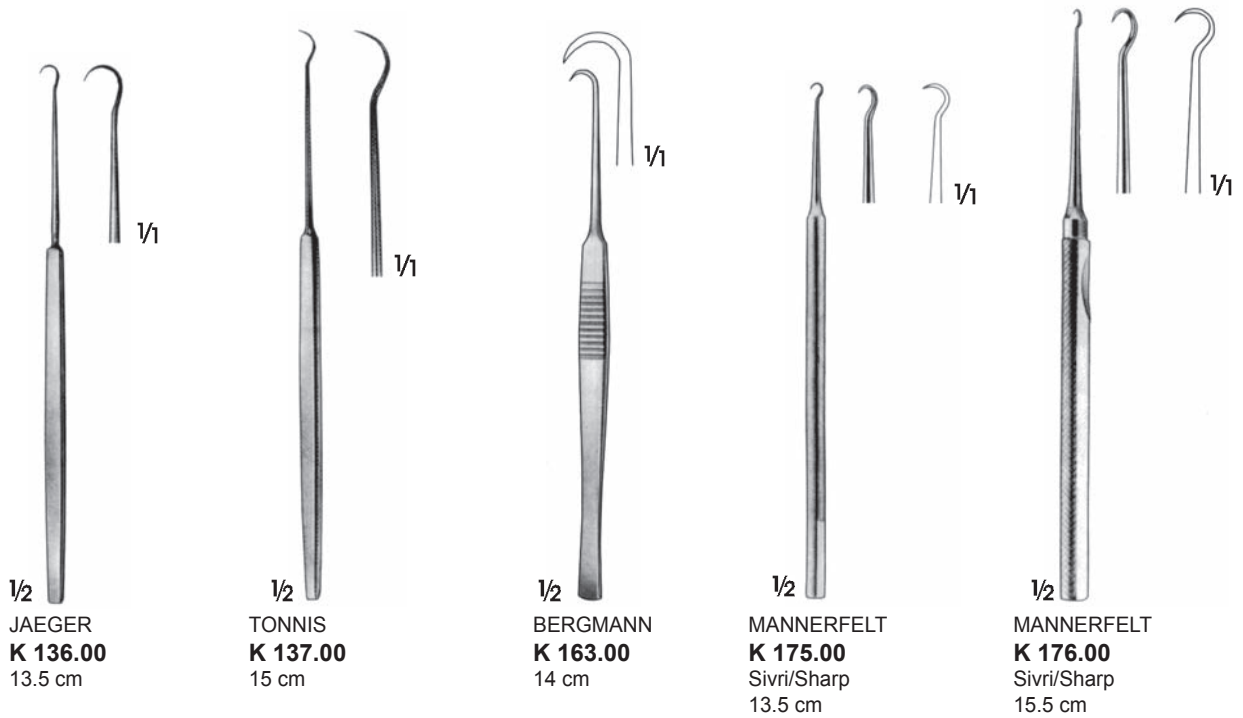
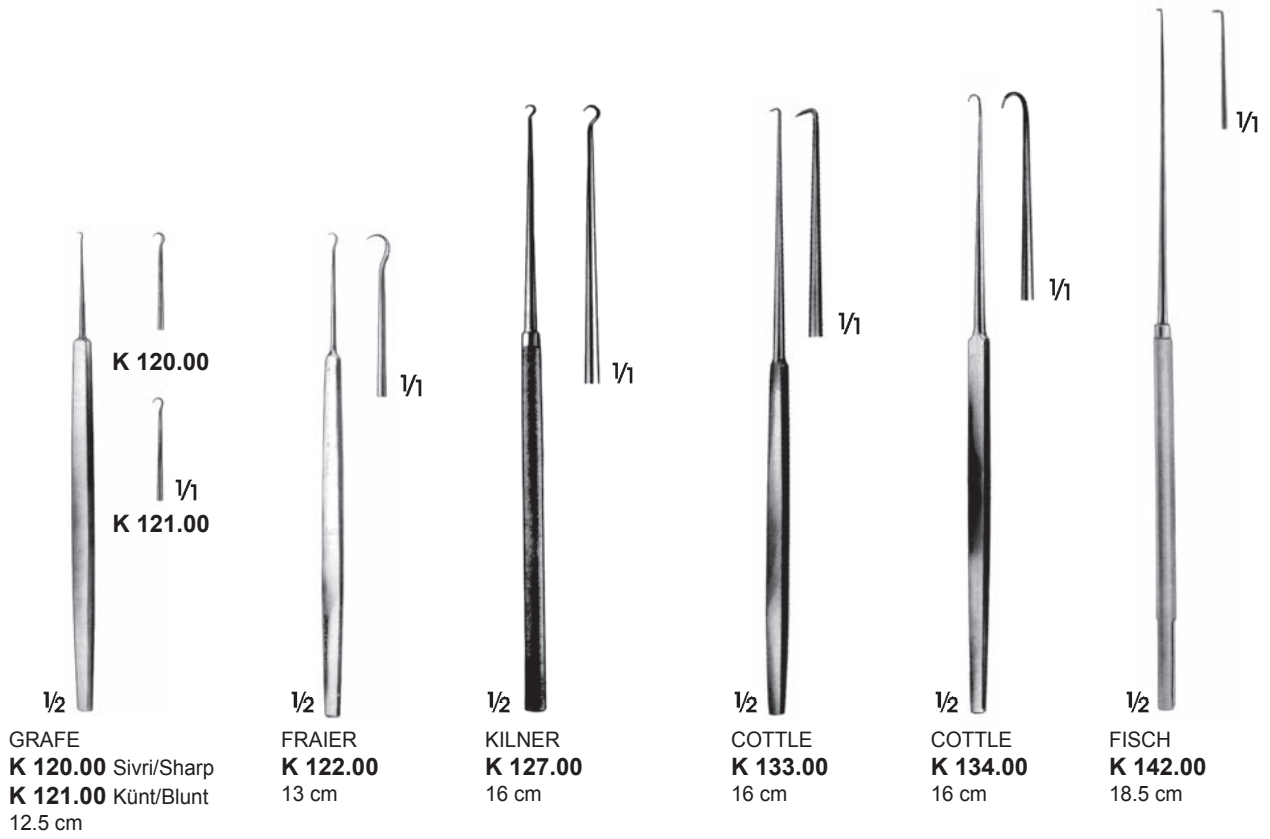

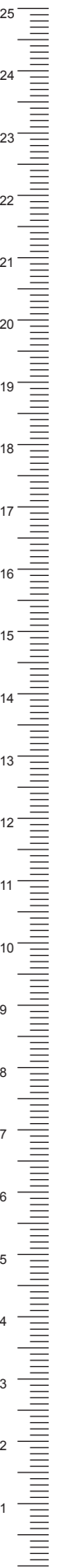
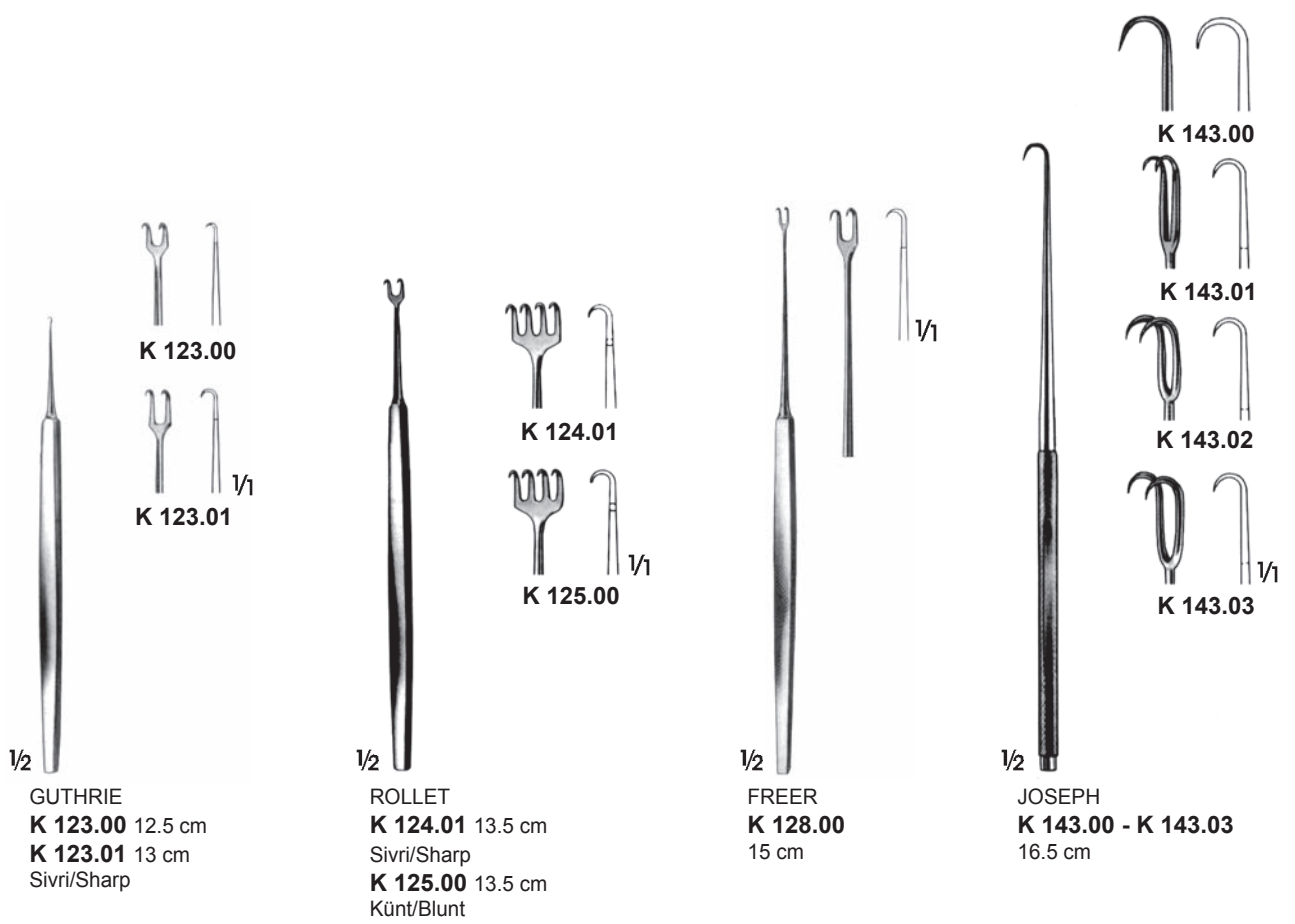
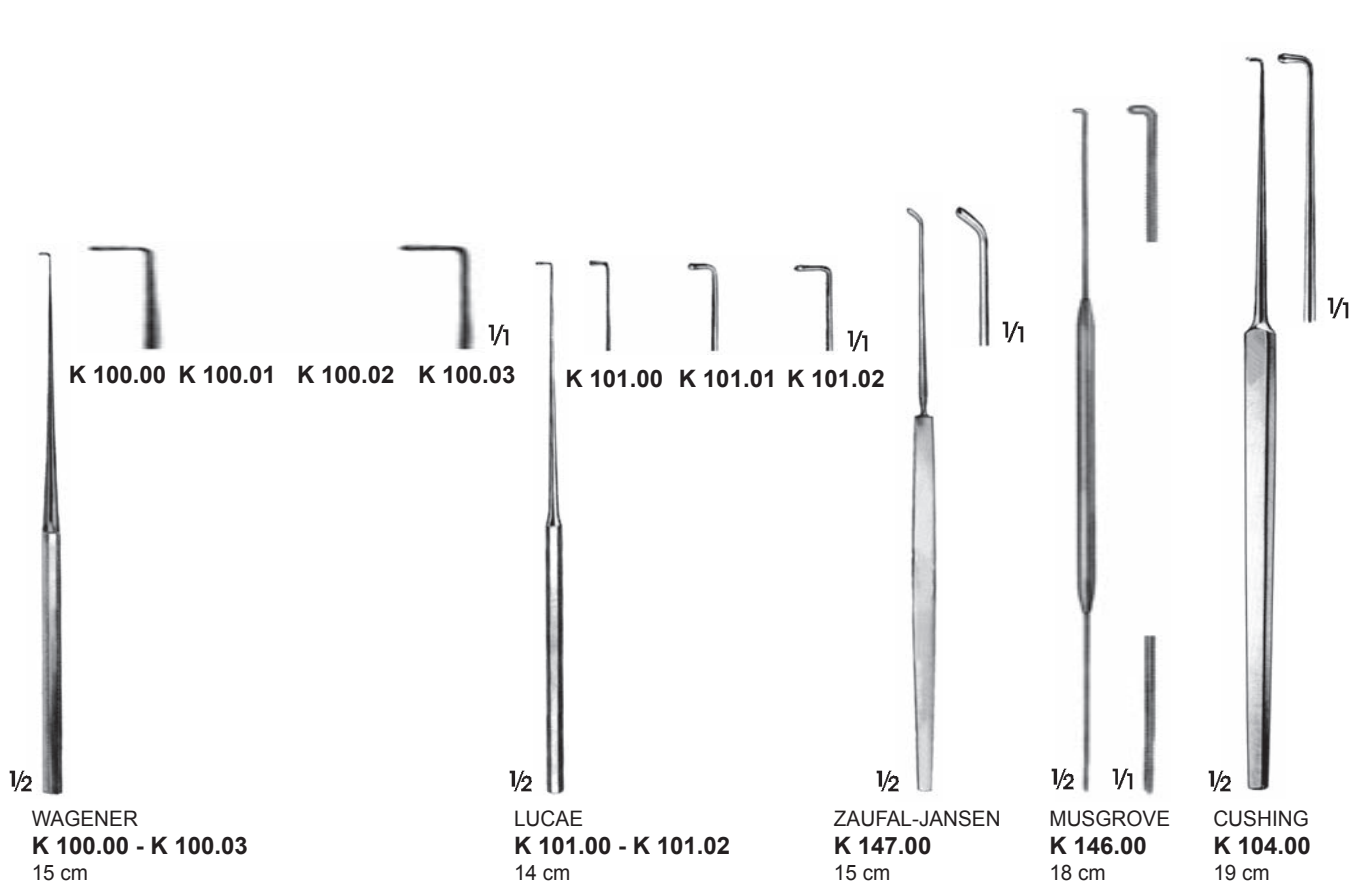

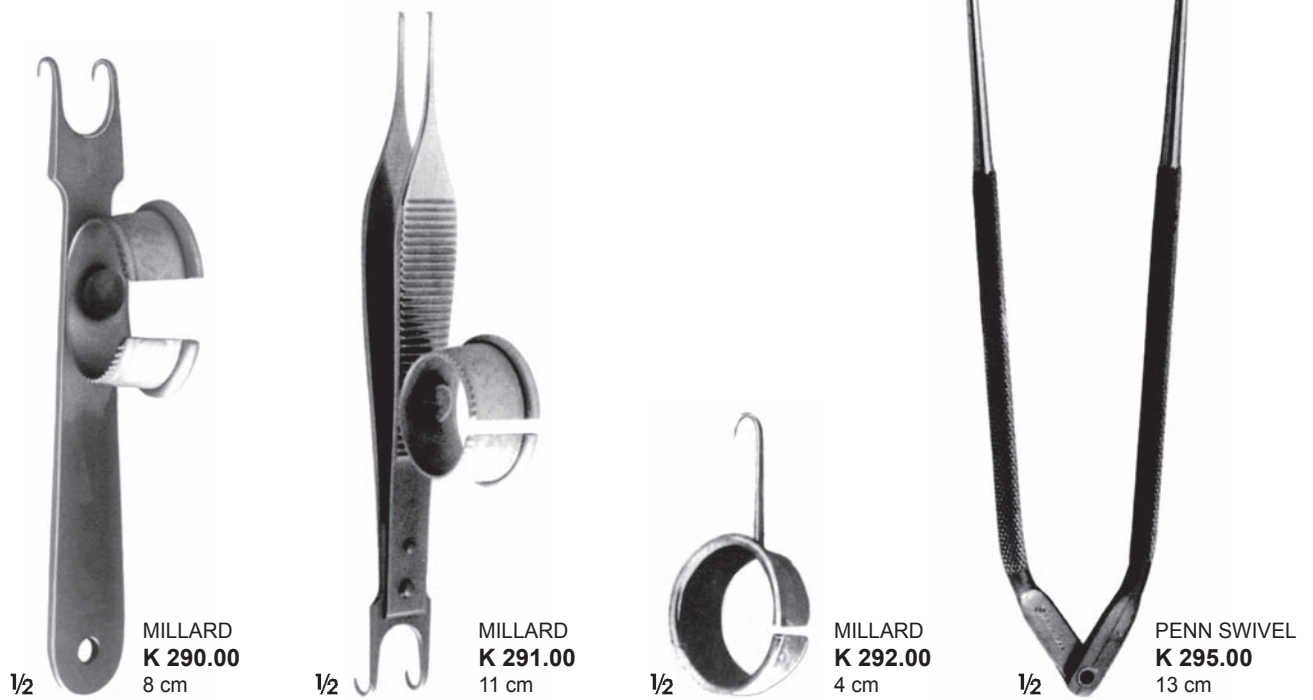
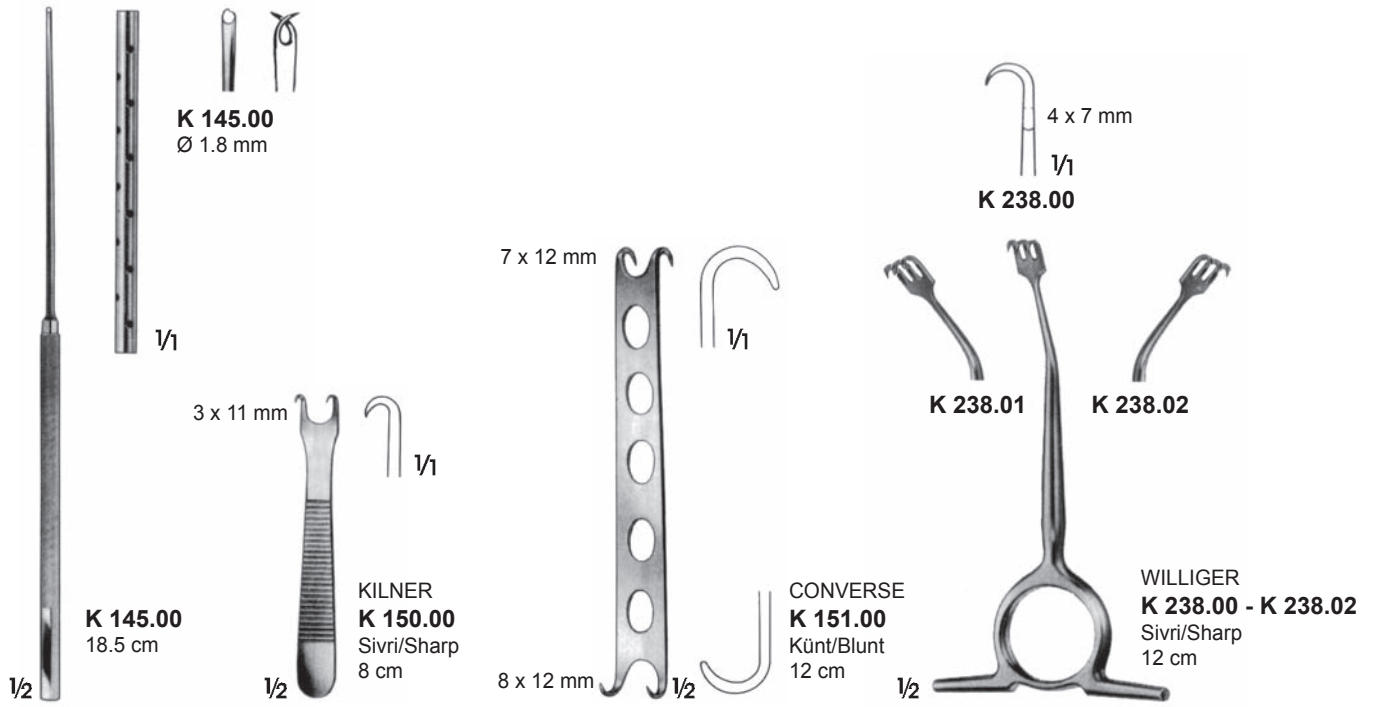

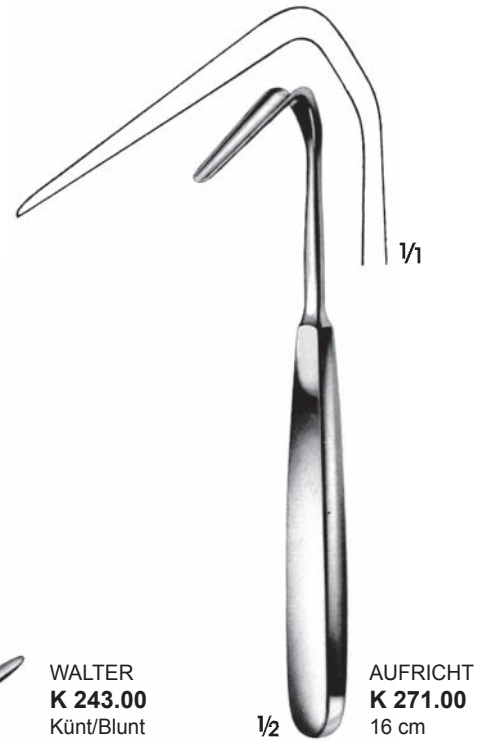
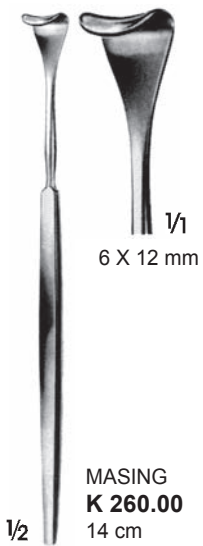
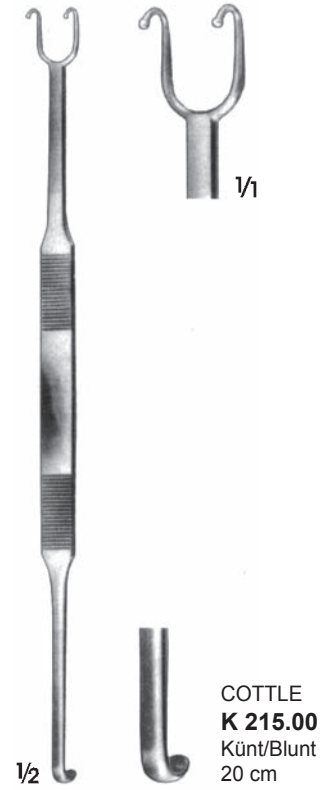
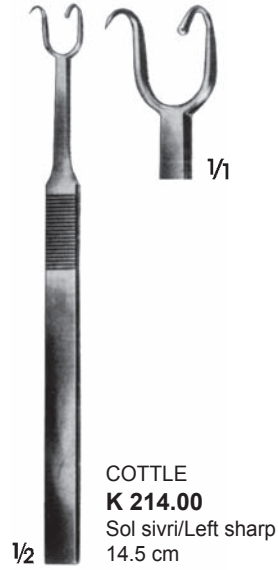
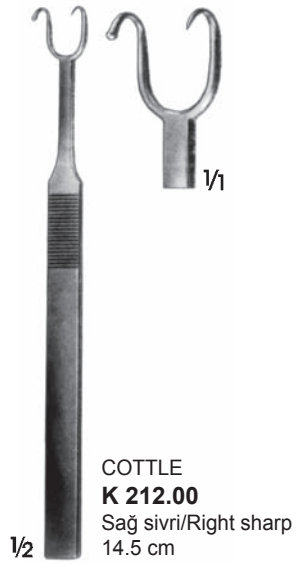
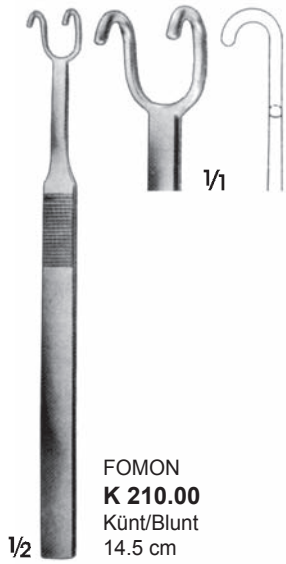

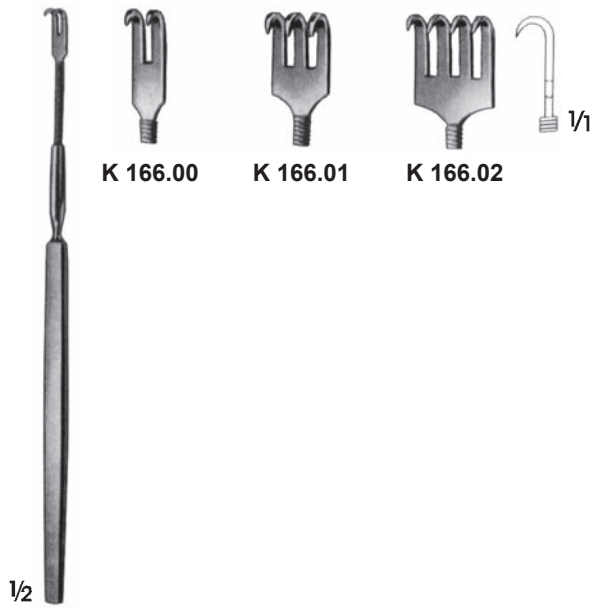

K 166.00 - K 166.02
Bükülebilir/Flexible
Sivri/Sharp
15.5 cm

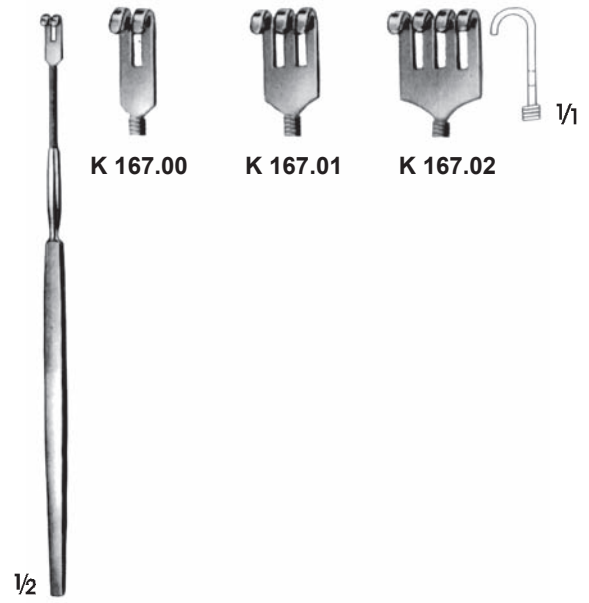

K 167.00 - K 167.02
Bükülebilir/Flexible
Künt/Blunt
15.5 cm

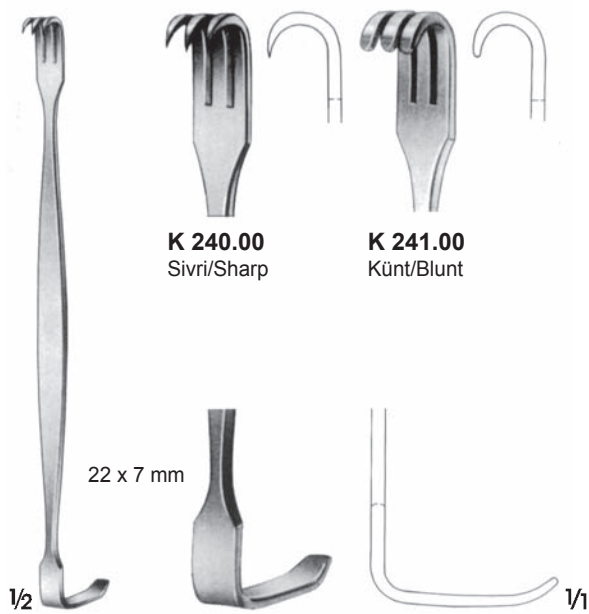

K 240.00
Sivri/Sharp
22 x 7 mm
K 241.00
Künt/Blunt
15.5 cm

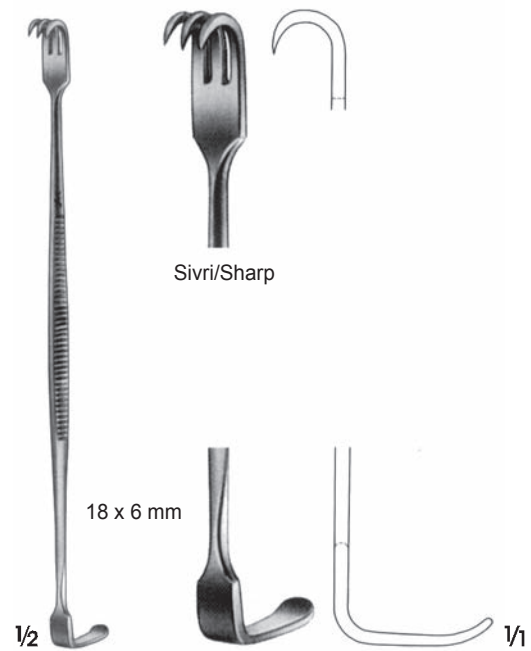

K 242.00
Sivri/Sharp
18 x 6 mm
16.5 cm

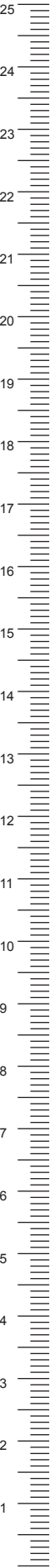

MANNERFELT
K 177.00
Sivri/Sharp
15.5 cm



MANNERFELT
K 178.00
Bükülebilir küçük, sivri
Flexible small, sharp
15.5 cm

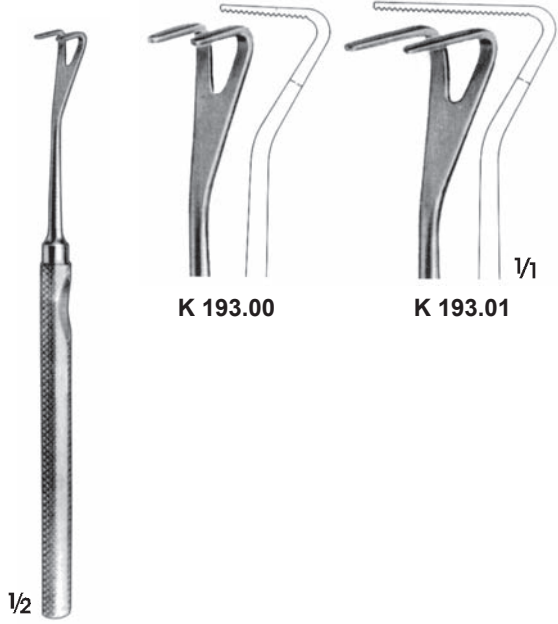

MANNERFELT
K 193.00 - K 193.01
15.5 cm



K 168.00 - K 168.03 Sivri/Sharp
K 169.00 - K 169.03 Künt/Blunt
Küçük/Small
16.5 cm

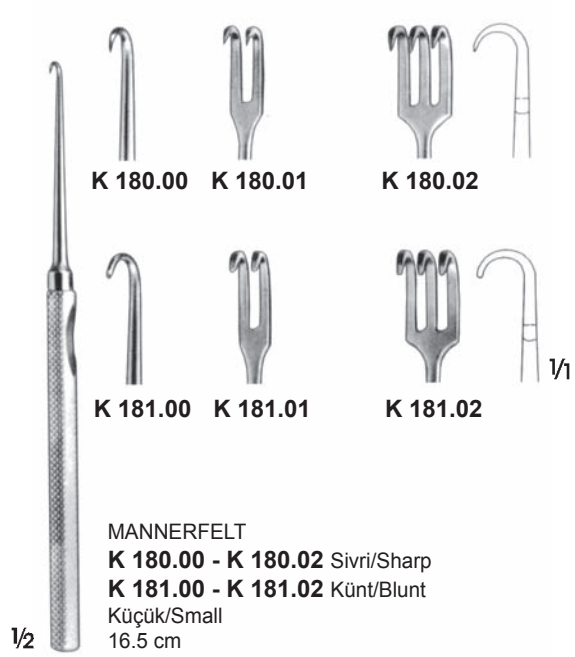

MANNERFELT
K 180.00 - K 180.02 Sivri/Sharp
K 181.00 - K 181.02 Künt/Blunt
Küçük/Small
16.5 cm

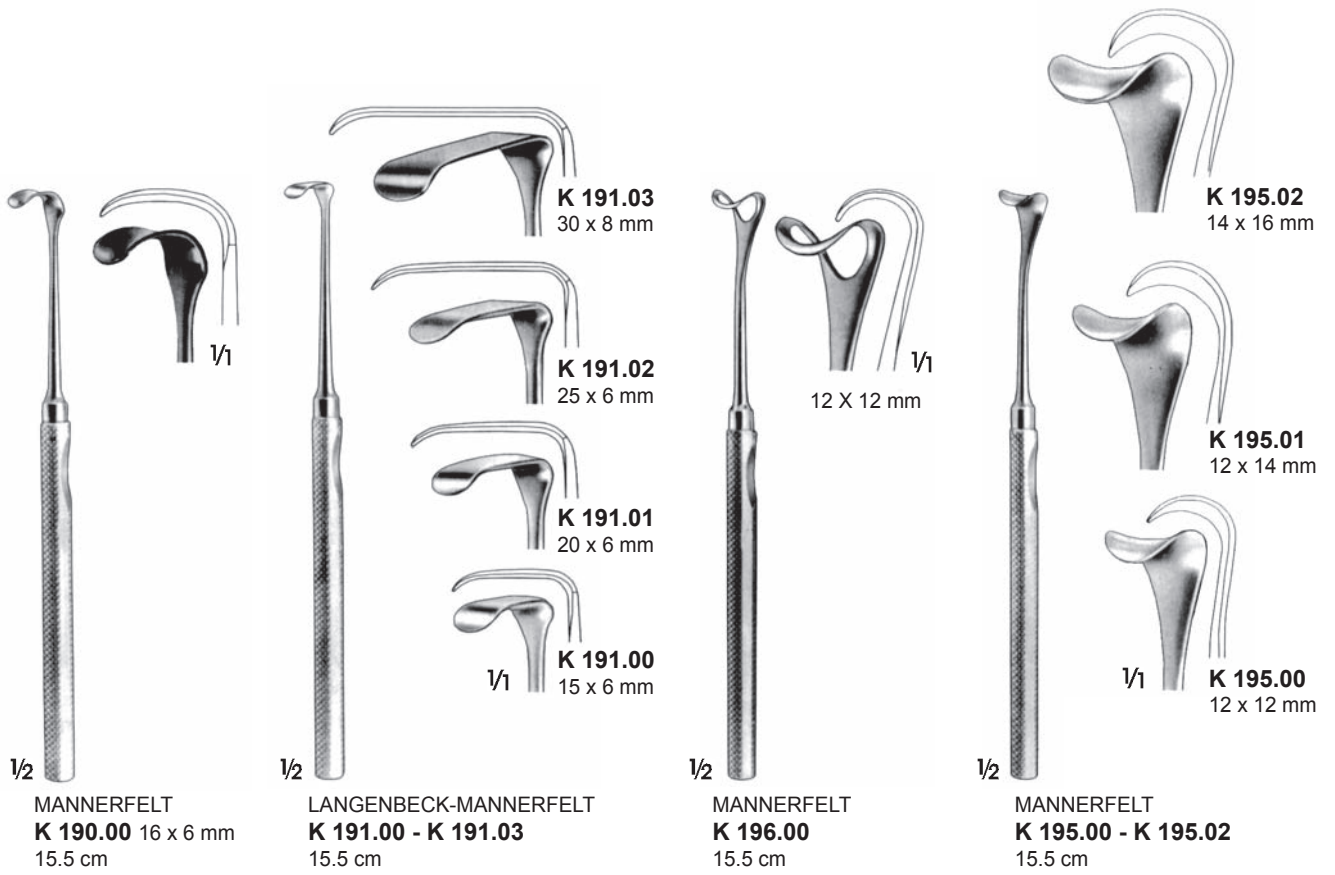

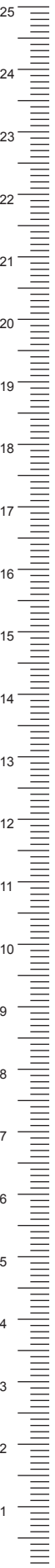
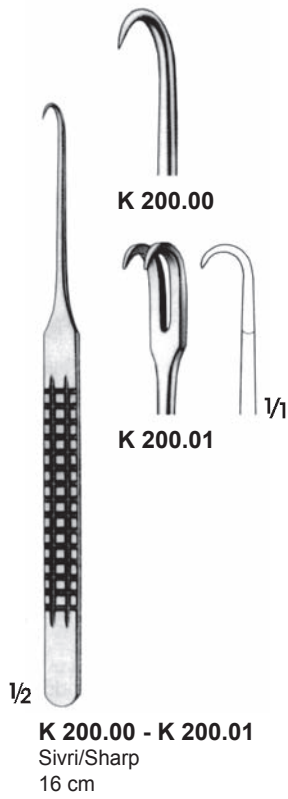

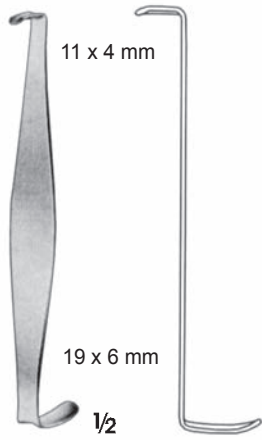

CRILE
K 300.00
11 cm

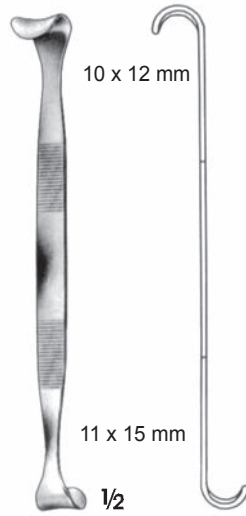

ROSE
K 302.00
13 cm

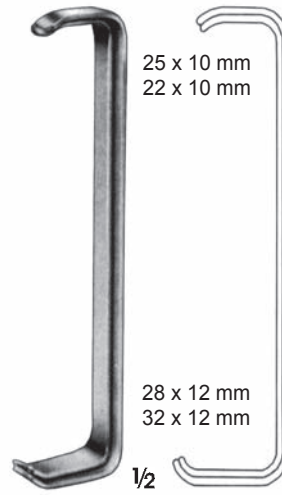

FARABEUF
K 310.00
12.5 cm

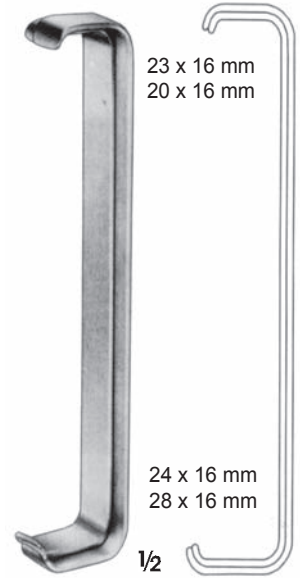

FARABEUF
K 311.00
15 cm



BABY-ROUX
K 315.00
13.5 cm



ROUX
K 325.00
Komple/Complete
16.5 cm
K 325.01 - K 325.03

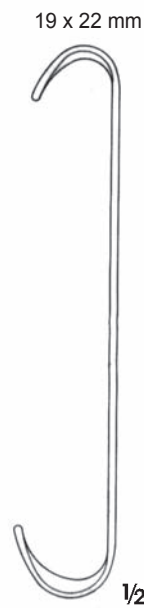

23 x 30 mm
K 325.01

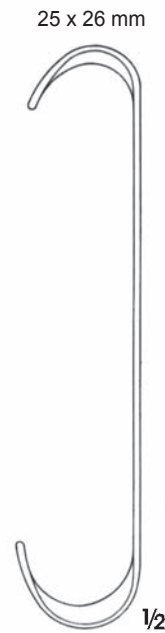

28 x 38 mm
K 325.02

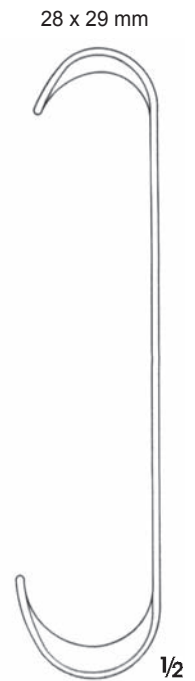

33 x 45 mm
K 325.03

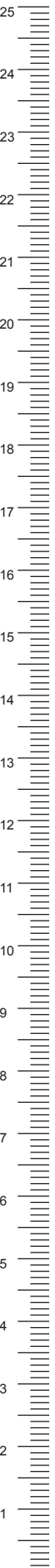
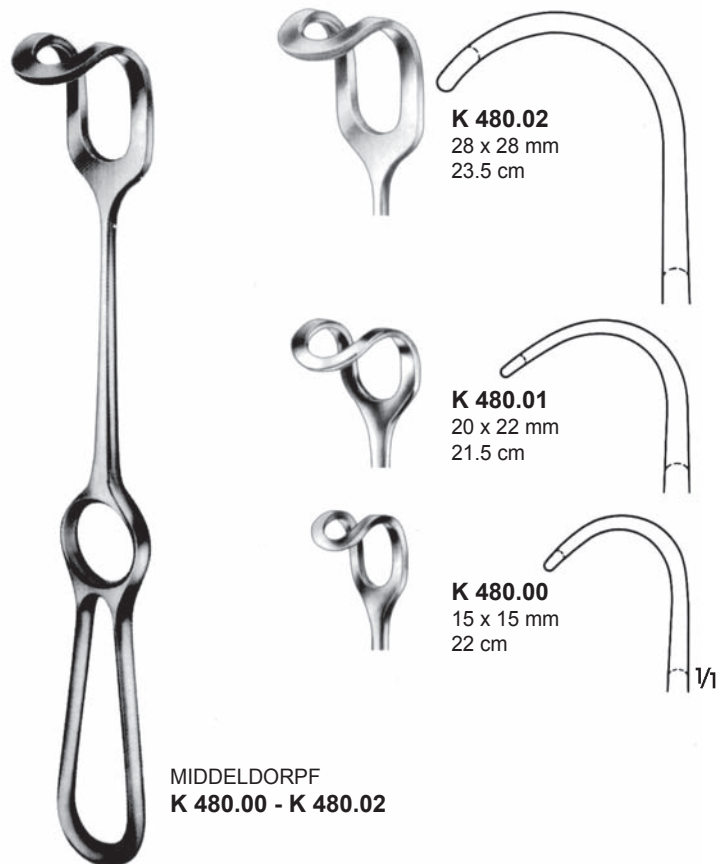
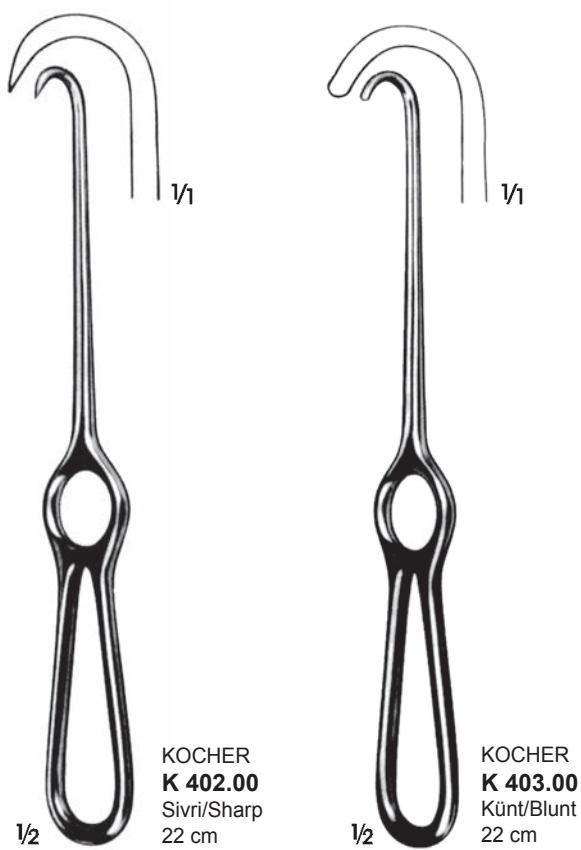
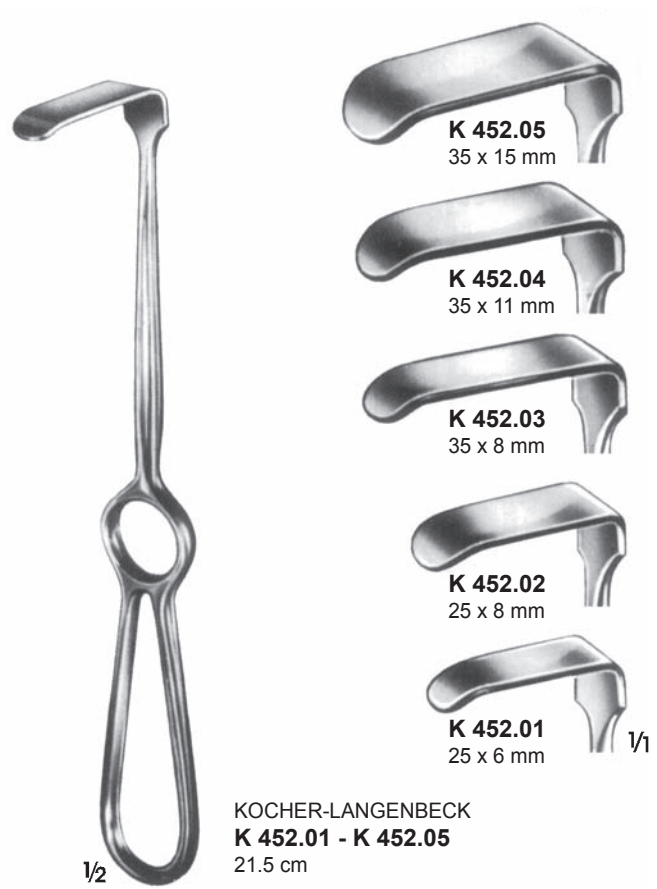
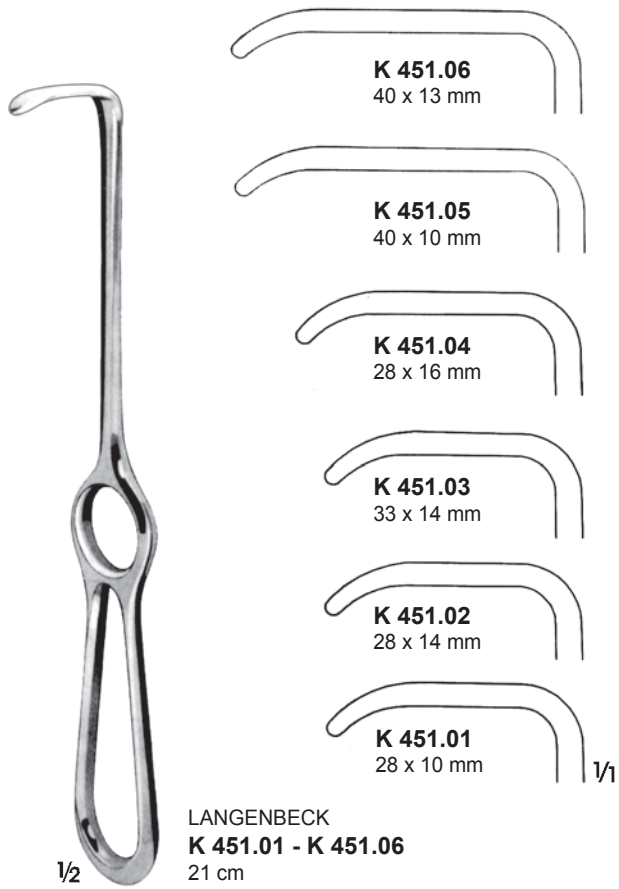



1/2
AGRIS-DINGMANN
M 762.01 Sağ/Right
M 762.02 Sol/Left



1/2
A 520.00 Ø 35 mm
A 520.01 Ø 40 mm
A 520.02 Ø 45 mm
A 520.03 Ø 50 mm
A 520.04 Ø 55 mm

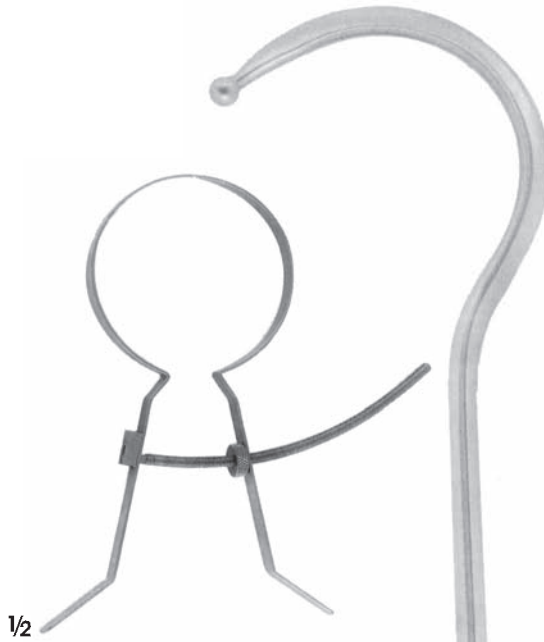

1/2
A 521.00 Ø 35 mm
A 521.01 Ø 40 mm
A 521.02 Ø 45 mm
A 521.03 Ø 50 mm
A 521.04 Ø 55 mm



1/2
M 765.01
Meme markörü
Aerola marker
38 X 42 mm



1/2
M 765.02
Meme kesme markörü
Aerola cutting marker
38 X 42 mm



1/2
OZUN
M 765.03
Meme markörü
Aerola marker
38 X 42 mm



1/2
K 783.01
Küçük boy/Small size

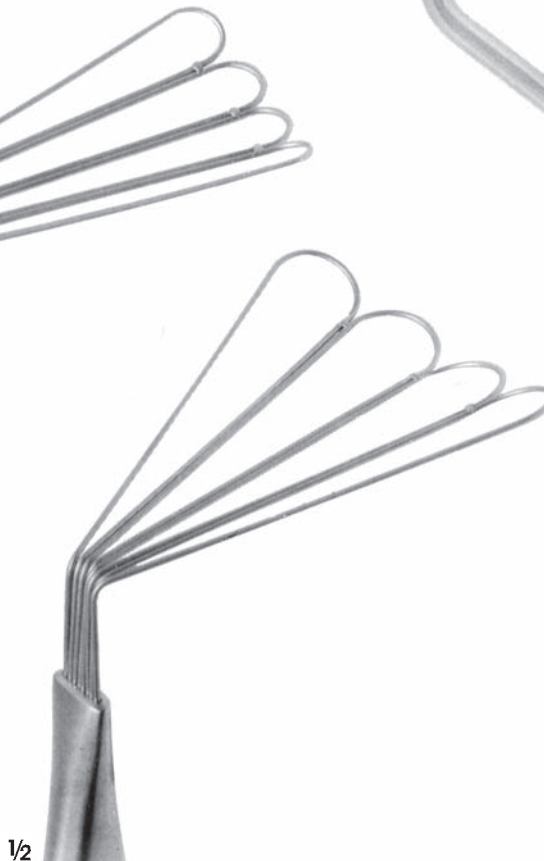

1/2
K 783.02
Büyük boy/Large size



1/2
GRECO-SIMONS
M 763.01



K 780.00
150 X 30 mm

1/2



1/2

OZUN
K 781.00



1/2

L 671.00
Ayarlı tensör
Adjustable tensor

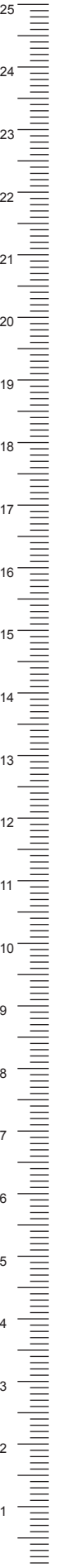

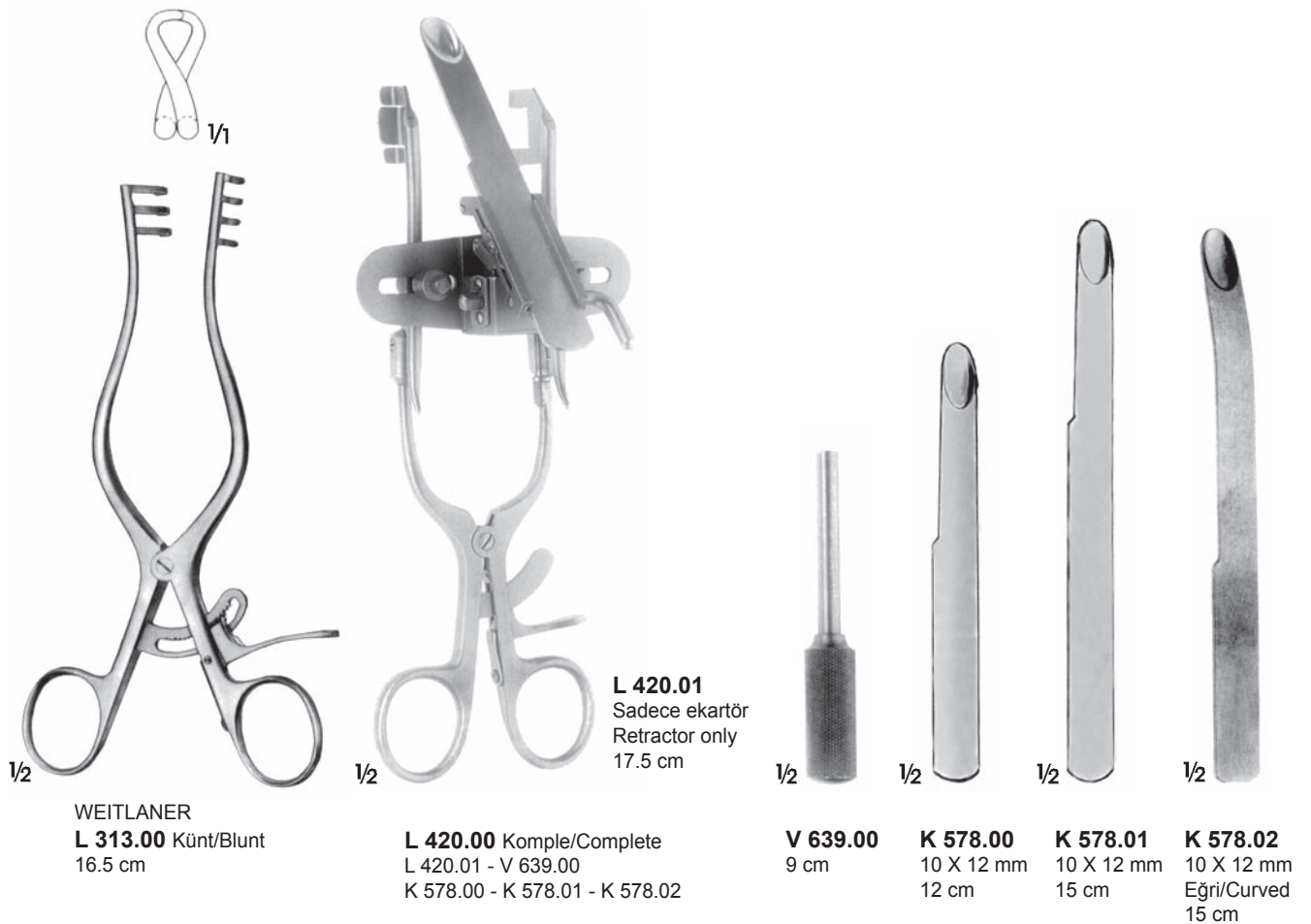
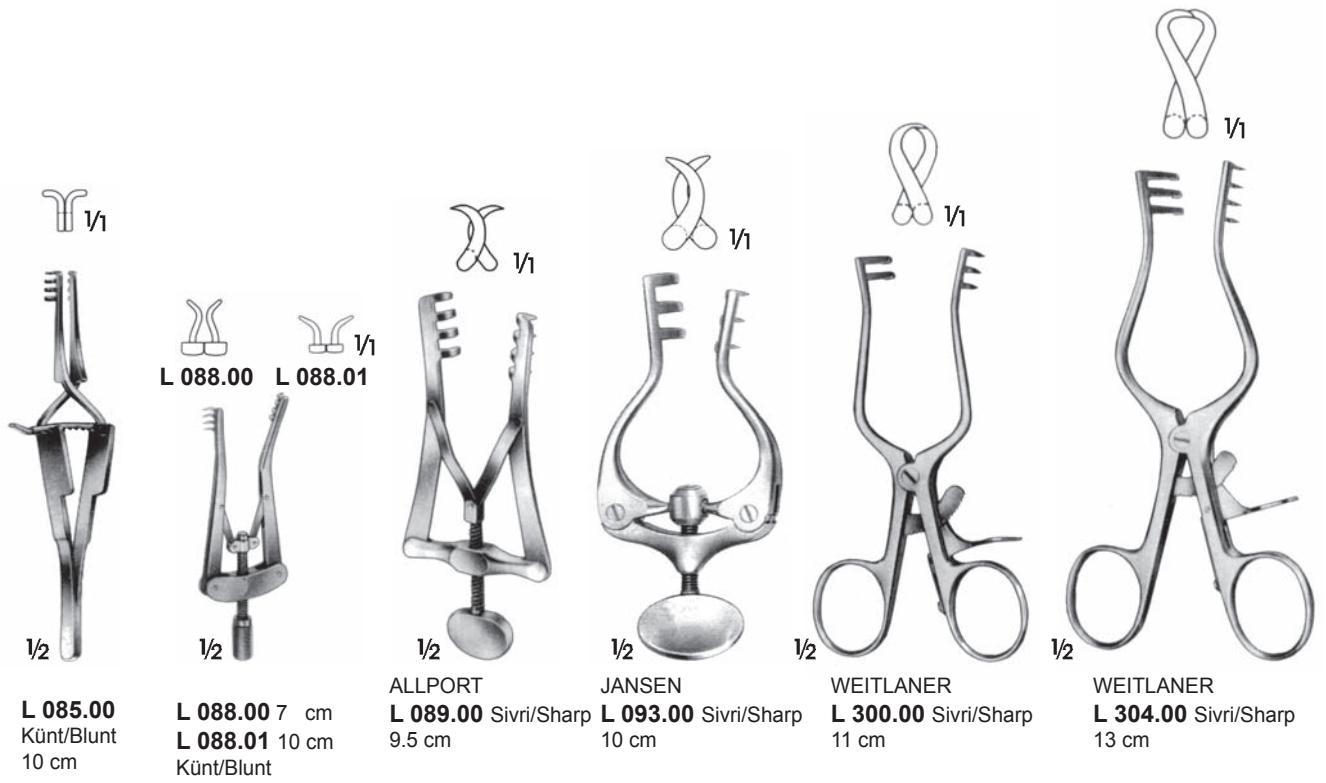

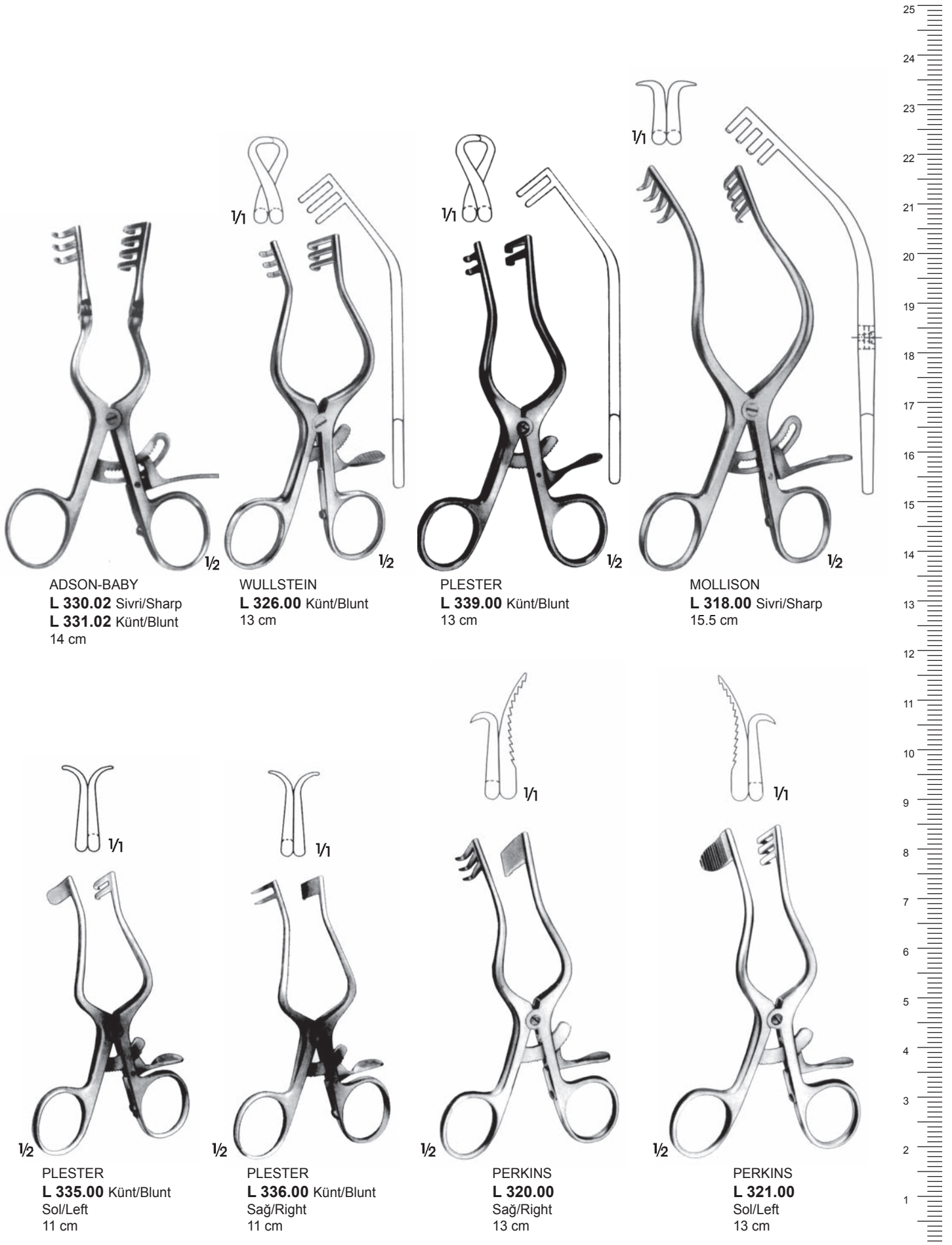



SEWAL
M 170.01 Künt/Blunt
20 cm



OBWEGESER
M 176.00 Sivri/Sharp
Sivri/Sharp
21 cm



OBWEGESER
M 176.01 Sivri/Sharp
Sivri/Sharp
21 cm

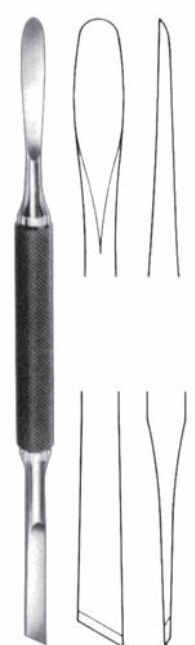

MEAD
M 200.01 Sivri/Sharp
Sivri/Sharp
16.5 cm



MOLT
M 201.01 Sivri/Sharp
Sivri/Sharp
18 cm

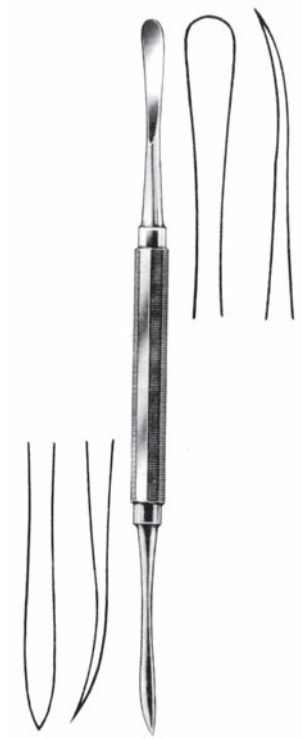

DINGMAN
M 203.01 Sivri/Sharp
Künt/Blunt
18 cm

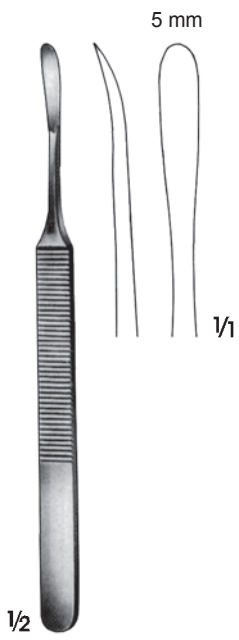

KONIG
M 214.00
15.5 cm

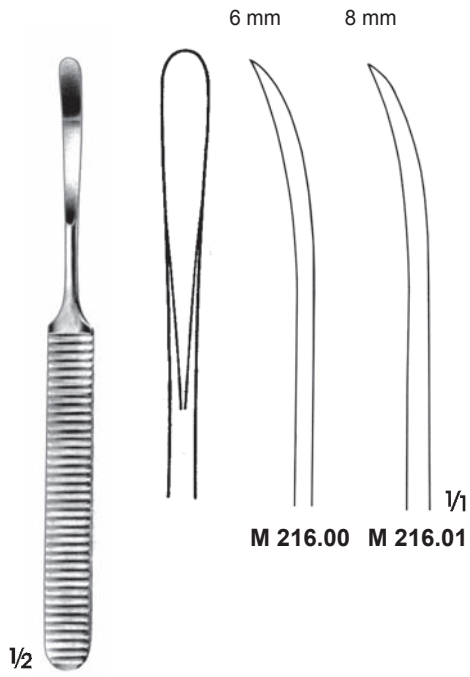

WILLIGER
M 216.00 - M 216.01
16 cm

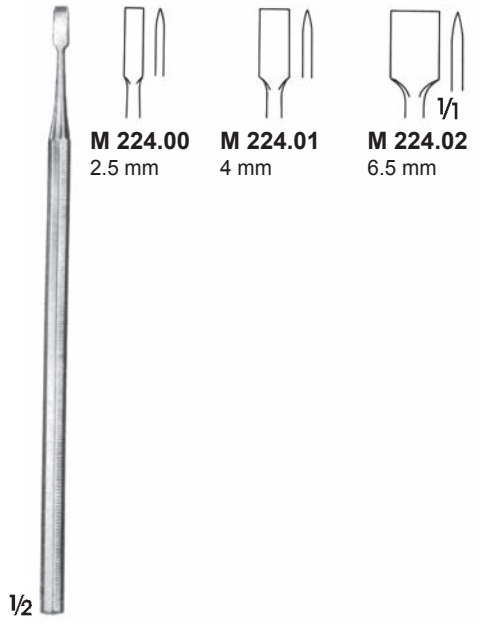

OBWEGESER
M 224.00 - M 224.02
15 cm

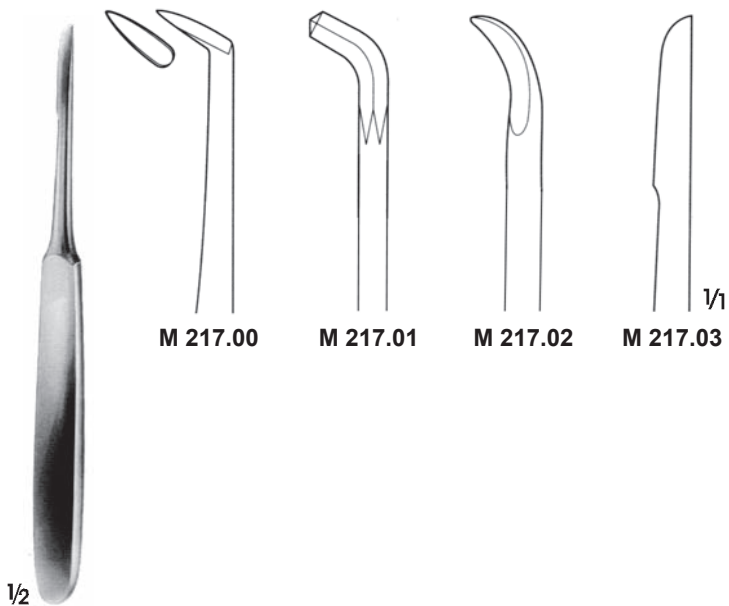

CHOMPRET
M 217.00 - D 217.03
15 cm

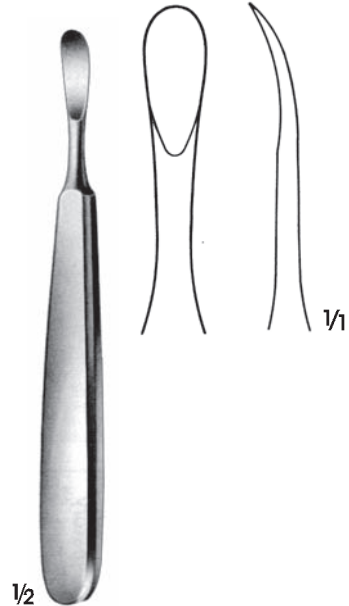
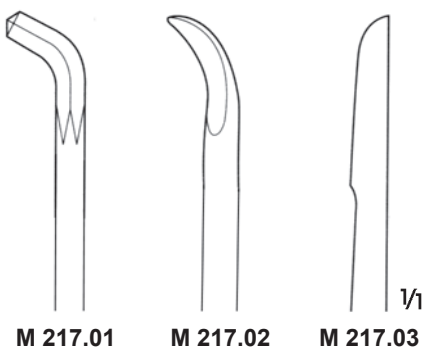

TRELAT
M 218.00
15 cm



STEINHAUSER
M 274.00 4 mm
17 cm

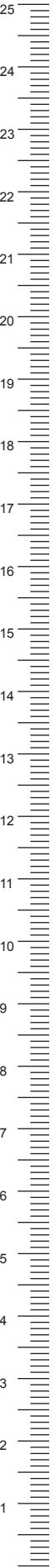

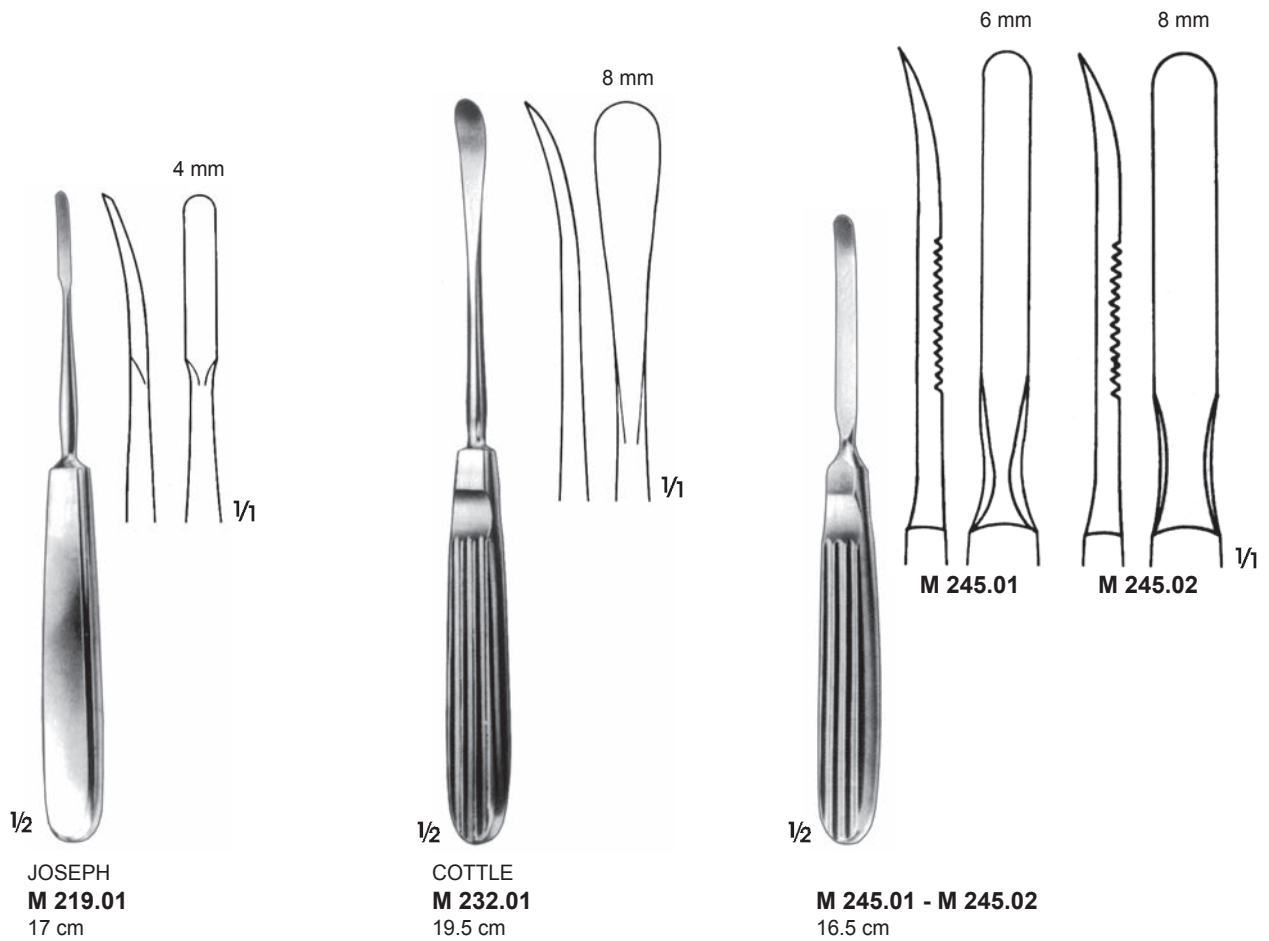
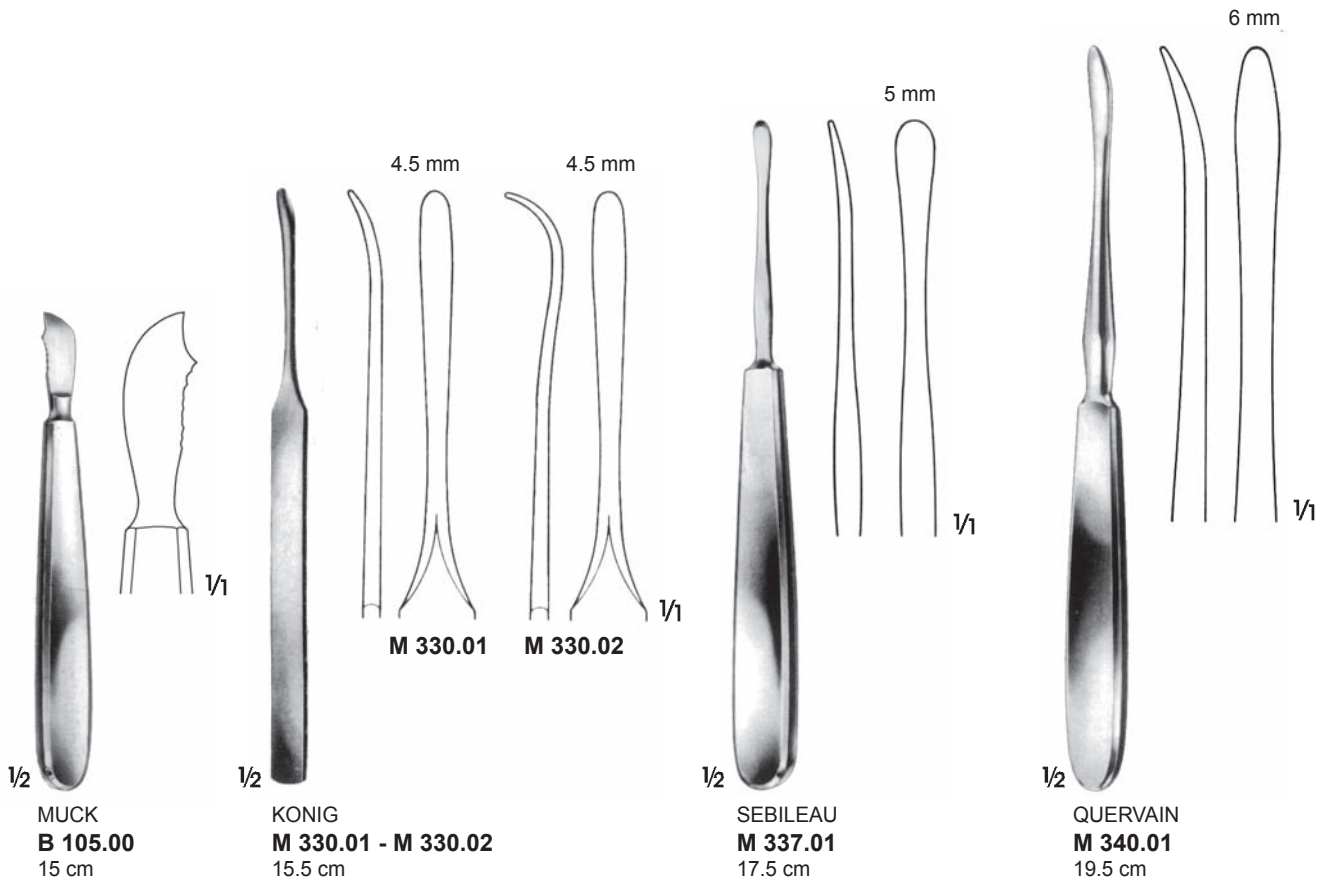

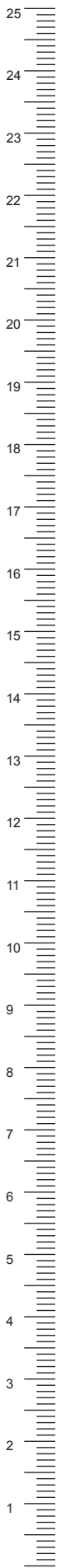
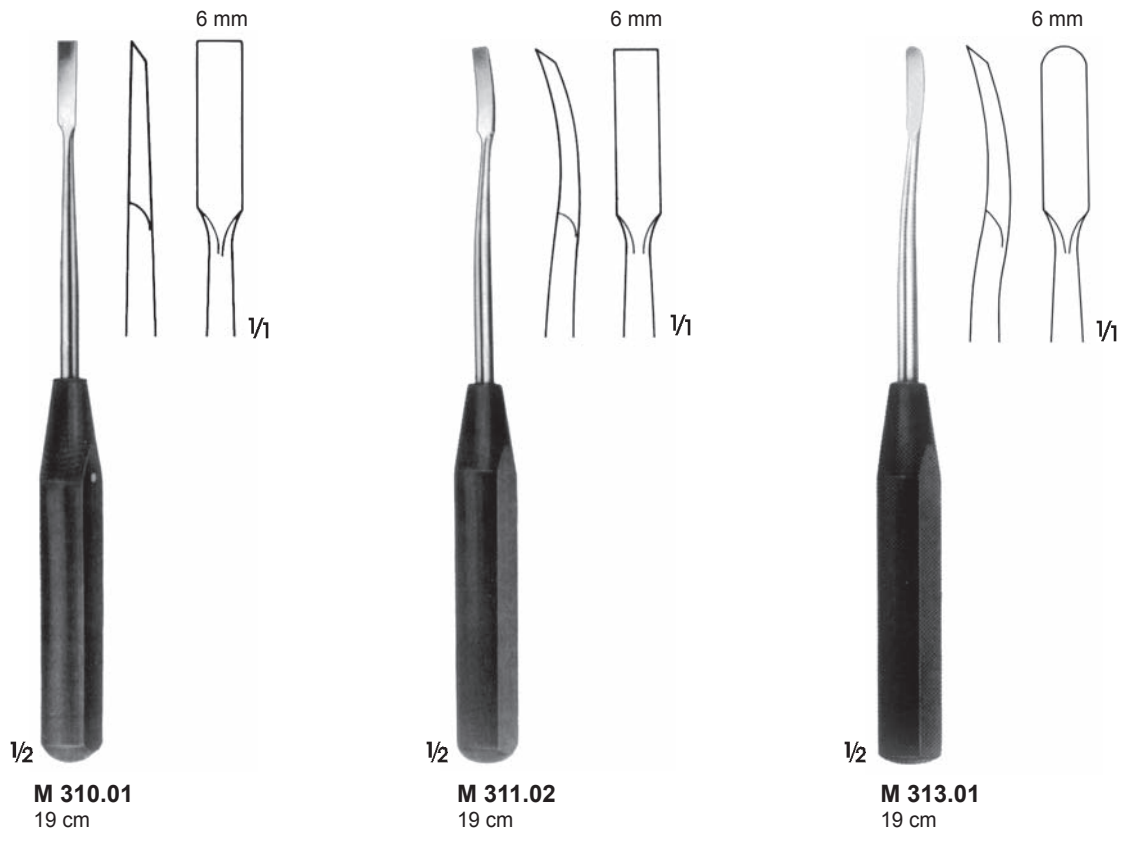
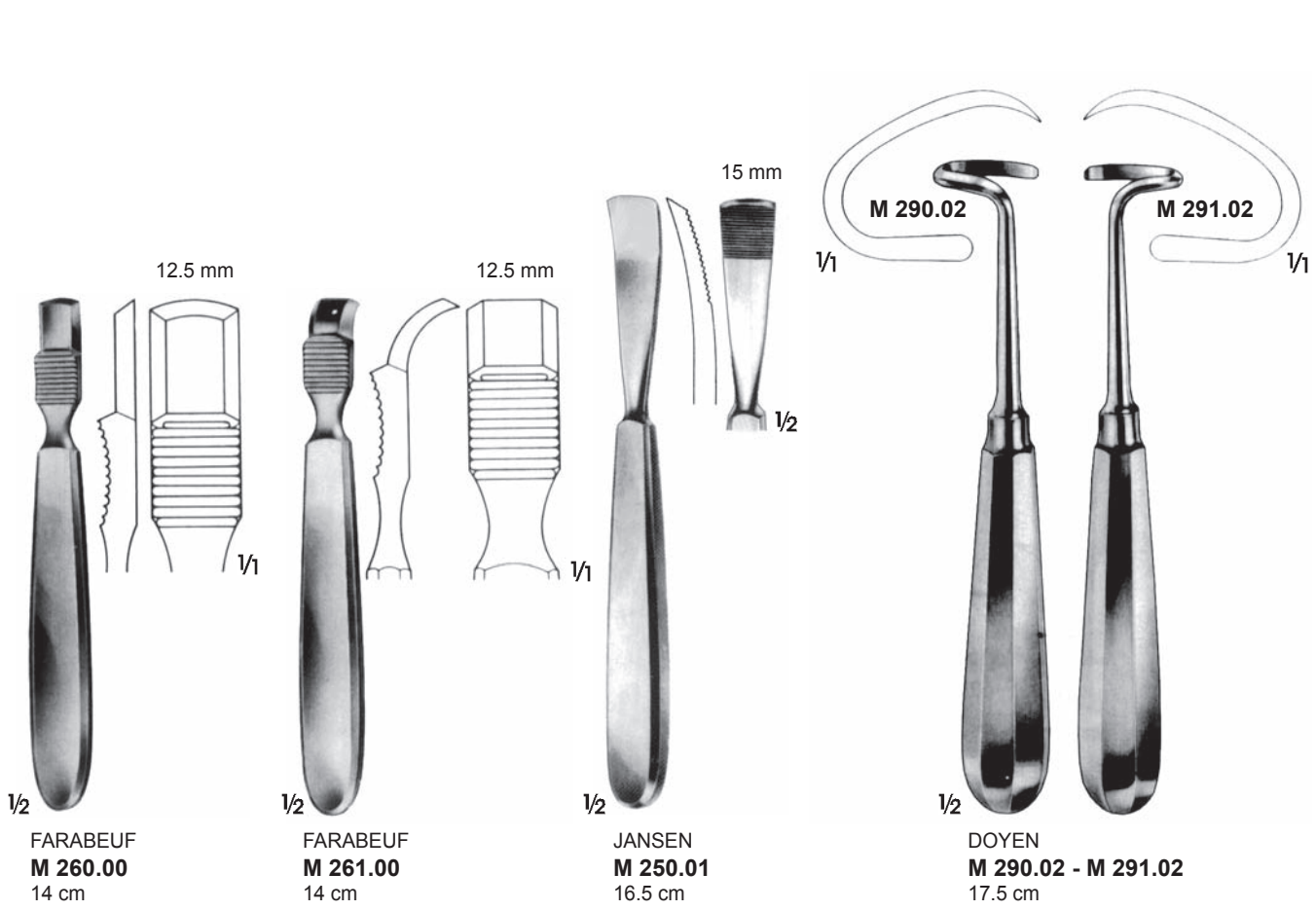

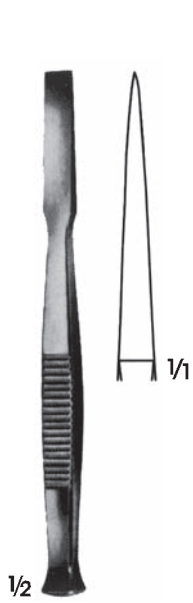

M 615.01 4 mm
M 615.02 6 mm
M 615.03 8 mm
M 615.04 10 mm
M 615.05 12 mm
 14 cm

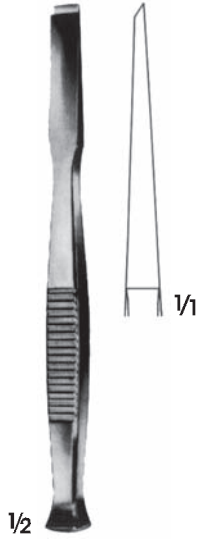

M 616.01 4 mm
M 616.02 6 mm
M 616.03 8 mm
M 616.04 10 mm
M 616.05 12 mm
 14 cm



PARTSCH
M 617.01 3 mm
M 617.02 4 mm
M 617.03 5 mm
M 617.04 6 mm
 14 cm

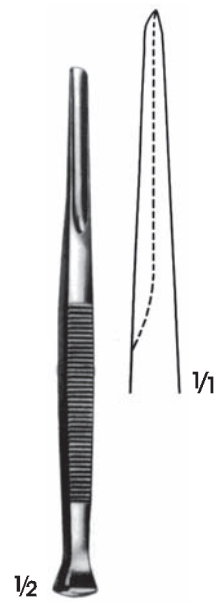

PARTSCH
M 620.01 3 mm
M 620.02 4 mm
M 620.03 5 mm
M 620.04 6 mm
 14 cm

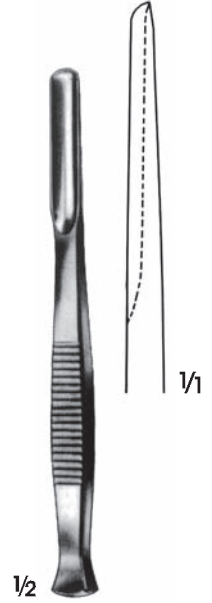

M 621.01 4 mm
M 621.02 6 mm
M 621.03 8 mm
M 621.04 10 mm
M 621.05 12 mm
 14 cm

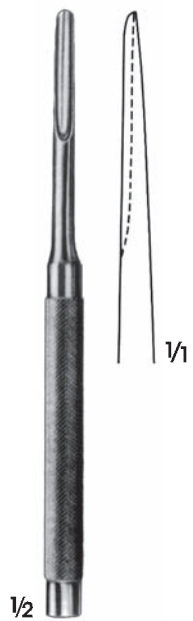

LUCAS
M 637.00 3 mm
M 637.01 5 mm
 16 cm



LUCAS
M 638.00 4 mm
M 638.01 6 mm
 16 cm

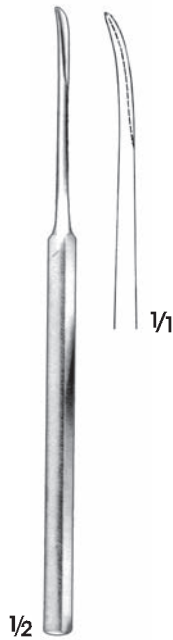



THIES
M 611.00 2 mm
M 611.01 3 mm
M 611.02 4 mm
 16 cm



PASSOW
M 751.00 - M 751.01
 12 cm



PASSOW
M 755.00 - M 755.01
 16 cm

 **M 755.01**
 Ø 5 mm
 1/1
M 755.00
 Ø 3 mm

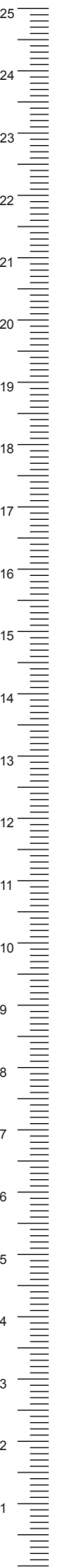
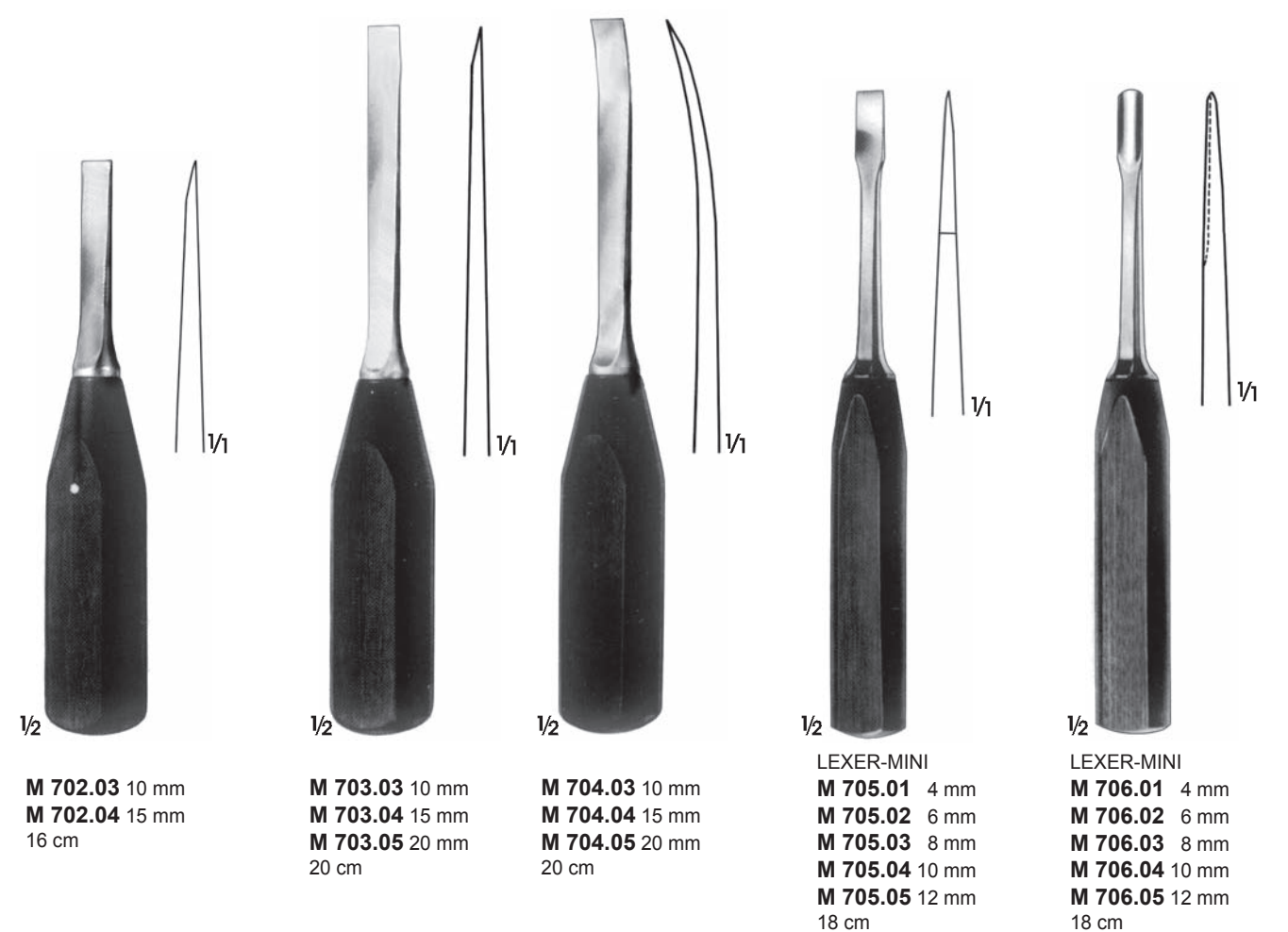

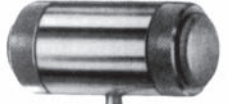

Ø 20 mm

1/2

MEAD
M 800.01 185 gr.
Plastik Diskli/Plastic Disks
19 cm

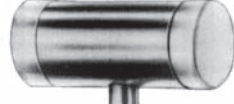

Ø 25 mm

1/2

M 801.00 140 gr.
Plastik Diskli/Plastic Disks
18.5 cm

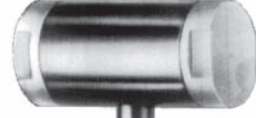

Ø 30 mm

1/2

M 802.01 215 gr.
Plastik Diskli/Plastic Disks
24.5 cm



M 802.02
Yedek plastik disk
Spare plastik disc

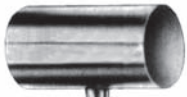

Ø 22 mm

1/2

M 811.01 165 gr.
19 cm



Ø 27 mm

1/2

HAJEK
M 812.01 140 gr.
21.5 cm

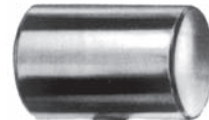

Ø 30 mm

1/2

COTTLE
M 815.01 240 gr.
18.5 cm

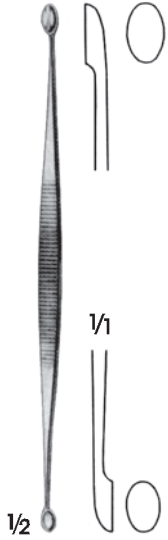

JACOBSON
N 130.00
14 cm

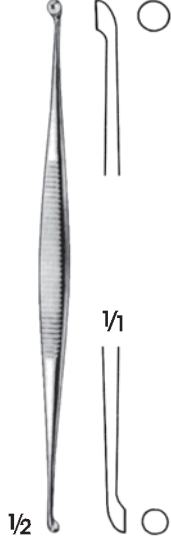

MARTINI
N 131.00
14 cm



WILLIGER
N 132.00
14.5 cm



JANSEN
N 133.00
16 cm



BARTH
N 135.00
18 cm



N 179.01
2.8 mm

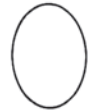

N 179.07
10 mm

N 179.02
3.6 mm



N 179.08
11.5 mm

N 179.03
4.4 mm



N 179.09
13 mm

N 179.04
5.2 mm



N 179.10
14.5 mm

N 179.05
6.8 mm

N 179.06
8.5 mm

N 186.01
1.8 mm

N 186.02
2.0 mm

N 186.03
2.4 mm

N 186.04
2.6 mm

N 186.05
2.8 mm



WILLIGER
N 180.01 - N 180.02
17 cm



WOLKMANN
N 179.01 - N 179.10
17 cm



LEMPERT
N 186.01 - N 186.05
21.5 cm



Otoloji - Kulak Mikrocerrahi
Otology - Ear Microsurgery



A 250.01
Ø 2 mm



A 250.02
Ø 3 mm



A 250.03
Ø 4 mm

POLITZER

A 250.00 3'lü Set/Set Of 3 Sizes
Çocuklar için/For children
Paslanmaz Çelik/Stainless Steel



A 251.01
Ø 3.5 mm



A 251.02
Ø 5.0 mm



A 251.03
Ø 6.5 mm



A 251.04
Ø 8.0 mm

HARTMANN

A 251.00 3'lü Set/Set Of 3 Sizes
(A 251.01, A 251.02, A 251.03)
Paslanmaz Çelik/Stainless Steel

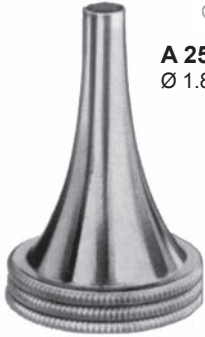

A 251.05
Ø 1.8 mm



A 251.06
Ø 3.2 mm



A 251.07
Ø 4.6 mm

HARTMANN

A 251.05 - A 251.07
Çocuklar için/For children
Paslanmaz Çelik/Stainless Steel

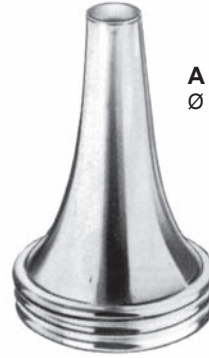

A 252.01
Ø 4.0 mm



A 252.02
Ø 5.5 mm



A 252.03
Ø 7.0 mm

TOYNBEE

A 252.00 3'lü Set/Set Of 3 Sizes
Paslanmaz Çelik/Stainless Steel



A 253.01
Ø 4.2 mm



A 253.02
Ø 5.2 mm



A 253.03
Ø 6.2 mm



A 253.04
Ø 7.2 mm

BOUCHERON

A 253.00 4'lü Set/Set Of 4 Sizes
Paslanmaz Çelik/Stainless Steel



A 254.01
Ø 8.0 mm







A 254.02
Ø 9.0 mm

HARTMANN







A 254.01 - A 254.02
İzoleli/Insulated
Paslanmaz Çelik/Stainless Steel



- | | | | |
|---|---|---|---|
|  |  |  |  |
| A 255.01
Ø 3 mm | A 255.02
Ø 4 mm | A 255.03
Ø 5 mm | A 255.04
Ø 7 mm |





HARTMANN
A 255.01 - A 255.04
Izoleli/Insulated
Paslanmaz Çelik/Stainless Steel



- | | | | | | |
|---|---|---|---|---|---|
|  |  |  |  |  |  |
| A 257.01
5.5 x 6.5 mm | A 257.02
6.5 x 7.5 mm | A 257.03
7.5 x 8.5 mm | A 257.04
8.5 x 9.5 mm | A 257.05
9.5 x 10.5 mm | A 257.06
10.5 x 11.5 mm |









ZÖLLNER
A 257.01 - A 257.06
Izoleli/Insulated
Paslanmaz Çelik/Stainless Steel



- | | | | | |
|---|---|---|--|---|
|  |  |  |  |  |
| A 258.01
3.3 x 4.0 mm | A 258.02
4.0 x 5.4 mm | A 258.03
5.0 x 7.3 mm | A 258.04
6.0 x 8.3 mm | A 258.05
7.3 x 9.7 mm |

SHEA
A 258.00 5'li Set/Set Of 5 Sizes
Paslanmaz Çelik/Stainless Steel



- | | | | | | | | |
|---|---|---|---|---|---|---|---|
|  |  |  |  |  |  |  |  |
| A 256.01
Ø 3.2 mm | A 256.02
Ø 5.0 mm | A 256.03
Ø 5.5 mm | A 256.04
Ø 6.2 mm | A 256.05
Ø 6.6 mm | A 256.06
Ø 7.0 mm | A 256.07
Ø 7.2 mm | A 256.08
Ø 9.2 mm |

TUMARKIN
A 256.00 8'li Set/Set Of 5 Sizes
Izoleli/Insulated
Paslanmaz Çelik/Stainless Steel



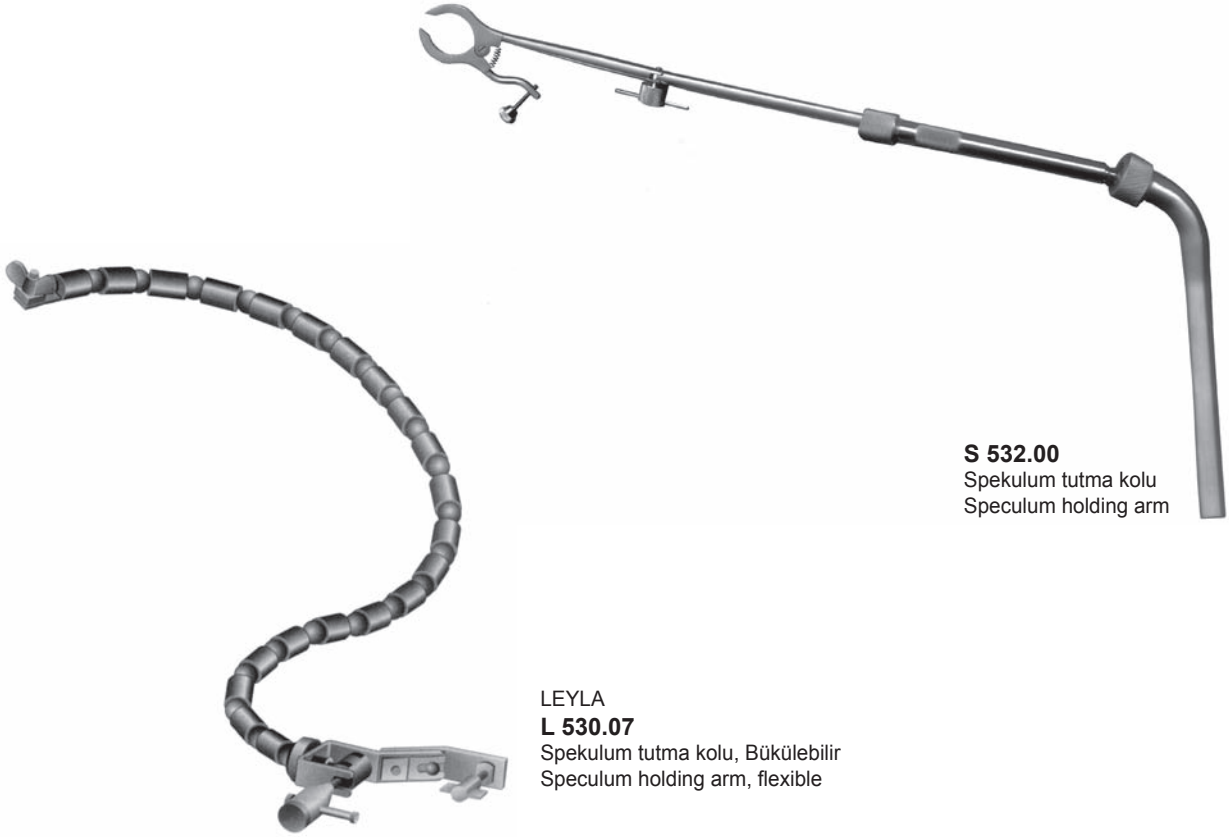

S 532.00
Spekulum tutma kolu
Speculum holding arm

LEYLA
L 530.07
Spekulum tutma kolu, Bükülebilir
Speculum holding arm, flexible



YASARGIL
S 530.05
Yalnız esnek kol
Flexible arm only

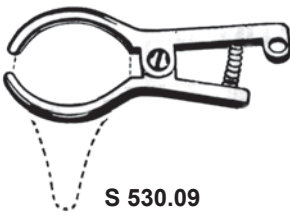

S 530.09
Spekulum tutucu
Speculum holder

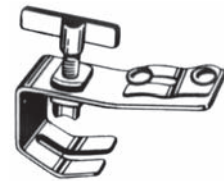

S 530.10
Tesbit elemanı
Fixation base

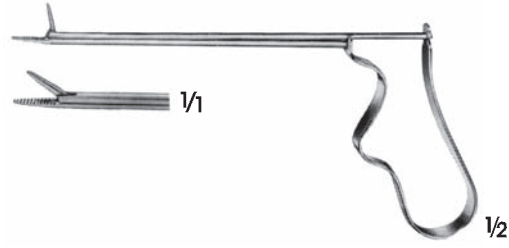

BUCK
R 220.00
Tırtıllı ağız/Serrated jaws
9 cm

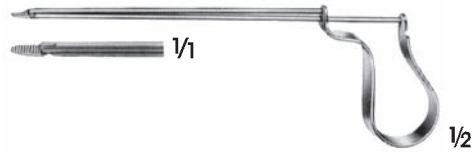

QUIRE
R 221.00
9 cm



HARTMANN
E 280.00
13.5 cm



HARTMANN
E 281.00
13.5 cm



TILLEY
E 282.00
14 cm

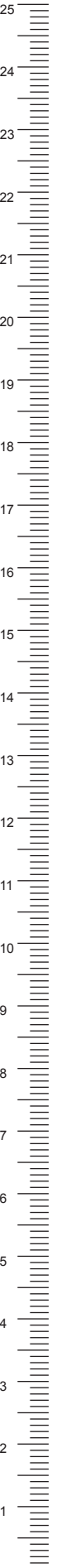

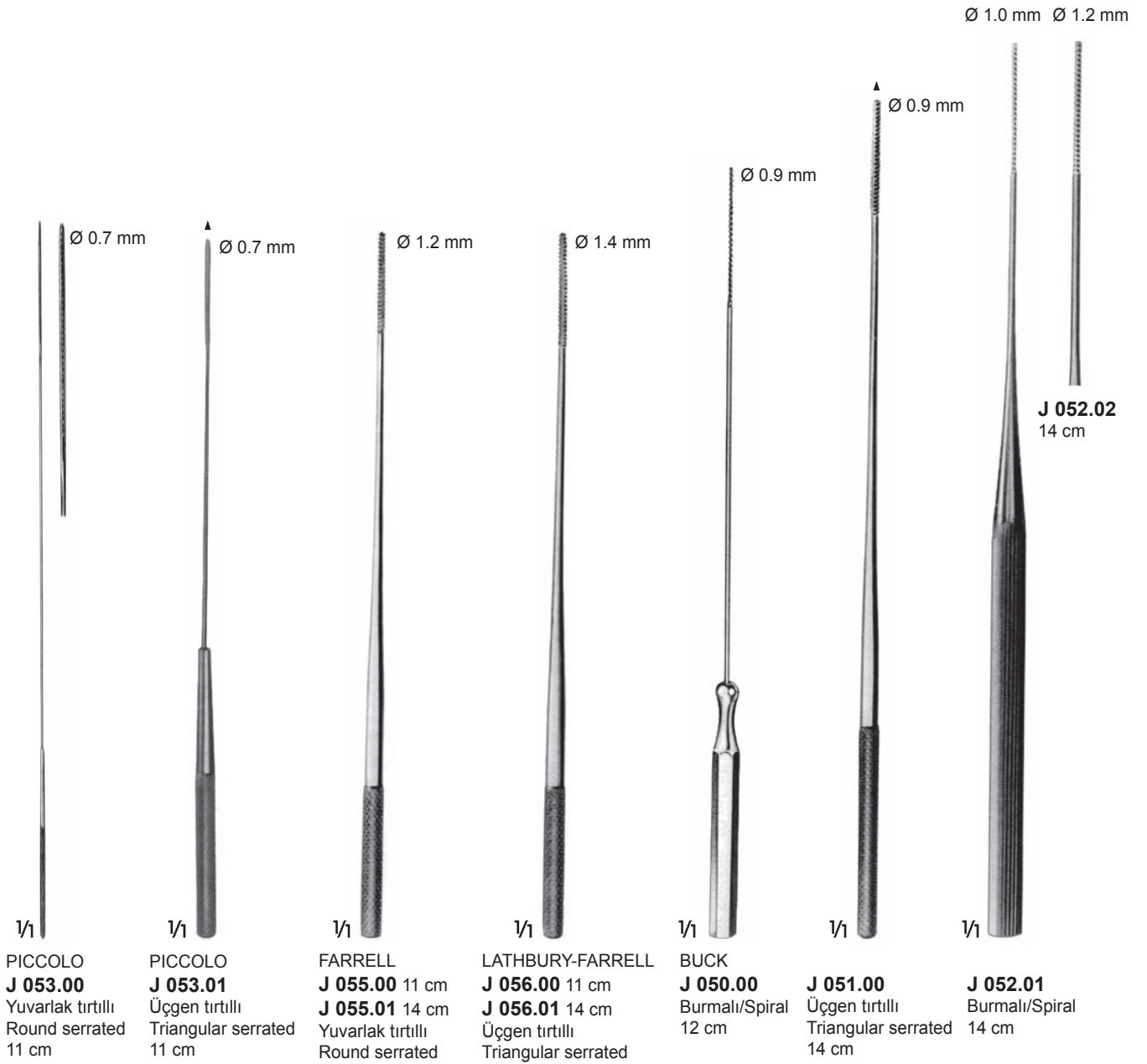

KABIERSCHE

J 190.00 Komple/Complete
(J 190.01 - J 190.06

J 190.01 Yalnız lastik üfleyici
Rubber bulb only

J 190.02 Uç/Tip

J 190.03 Uç/Tip

J 190.04 Uç/Tip

J 190.05 Metal bağlayıcı
Metal mounting

J 190.06 Yalnız yedek cam
Spare glass only

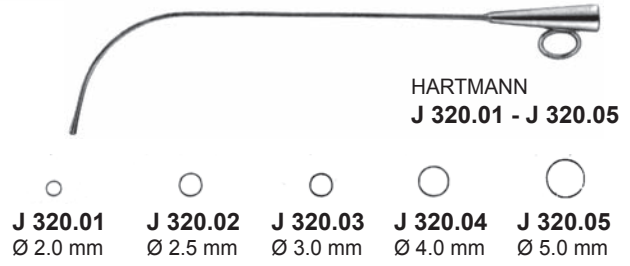
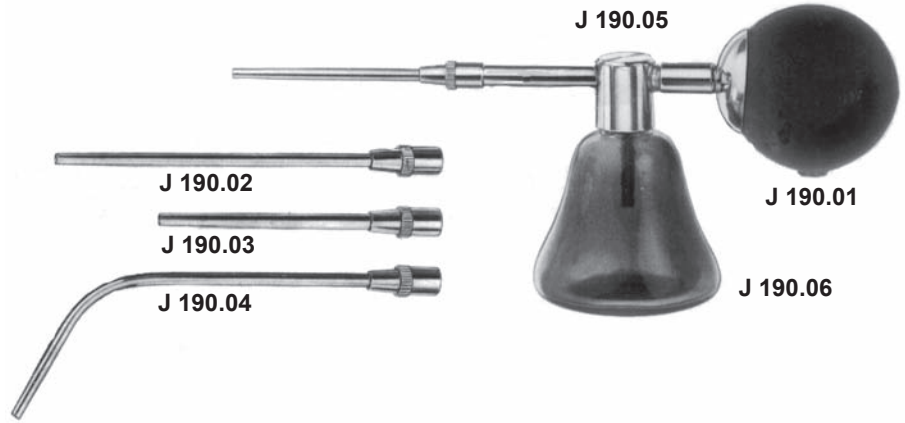

J 192.05
Metal bağlayıcı
Metal connector



J 192.01 Ø 18 mm
J 192.02 Ø 21 mm
J 192.03 Ø 23 mm
Metal uç/Metal tip



POLITZER
J 192.00



J 196.05
LUER-LOCK



J 196.06
LUER-LOCK



J 196.07

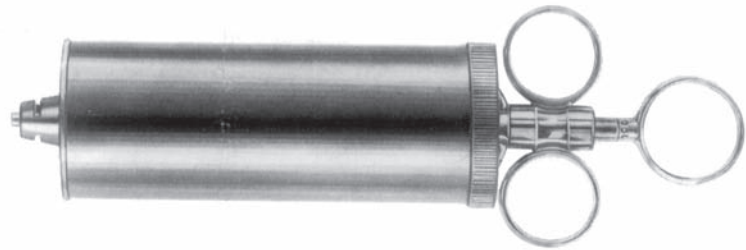

	Komple Complete	Yalnız Şiringa Syringe Only	Sivri Uc Tip Tapered	Yuvarlak Uc Tip Bulbous	Koruma Kalkanı Protection Shield
50 ml	J 193.00	J 196.01	J 196.05	J 196.06	J 196.07
75 ml	J 194.00	J 196.02			
100 ml	J 195.00	J 196.03			



Y 900.02 170 x 100 x 35 mm
Y 900.03 250 x 140 x 40 mm
Y 900.04 275 x 150 x 45 mm

1/3

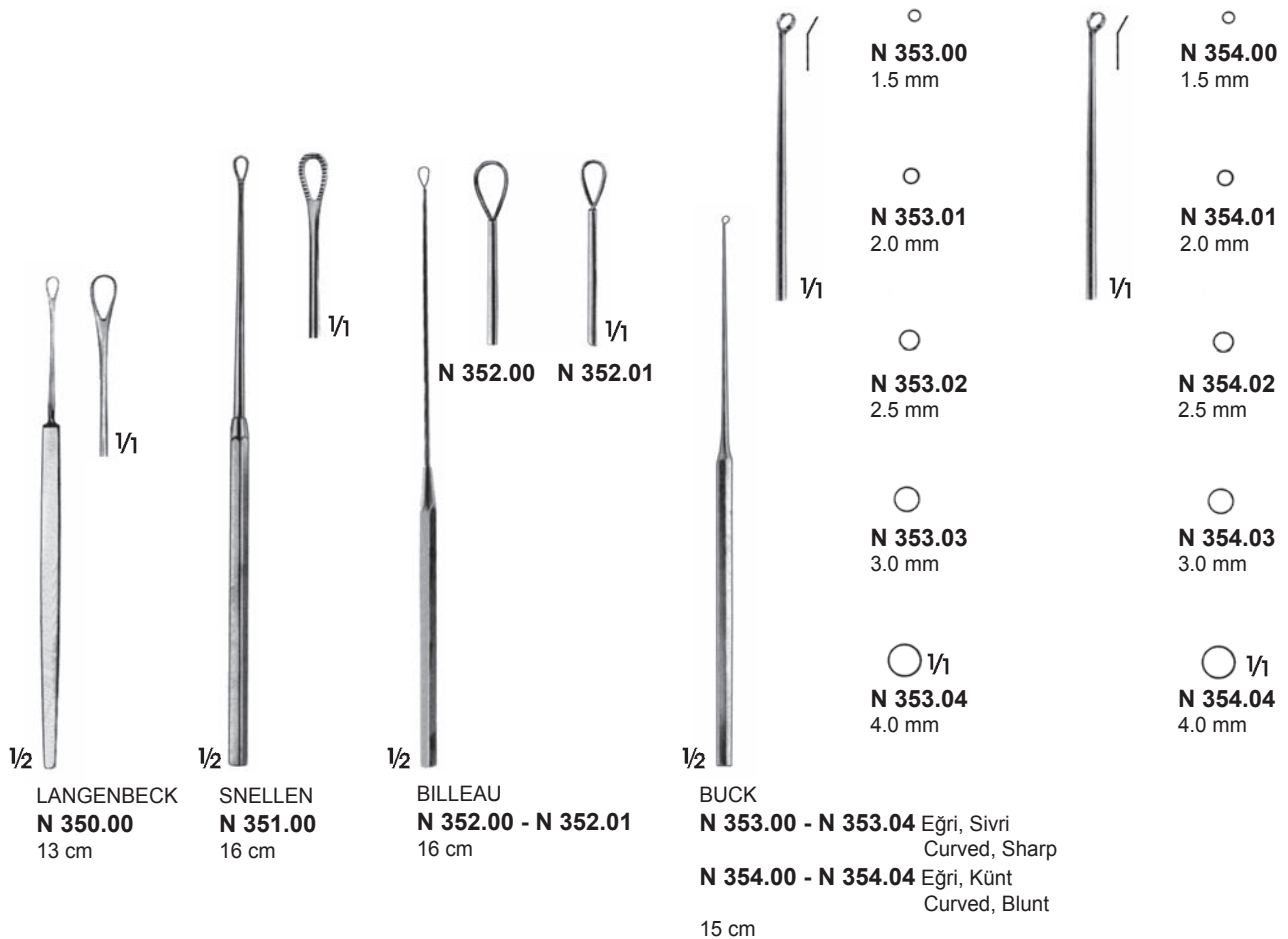
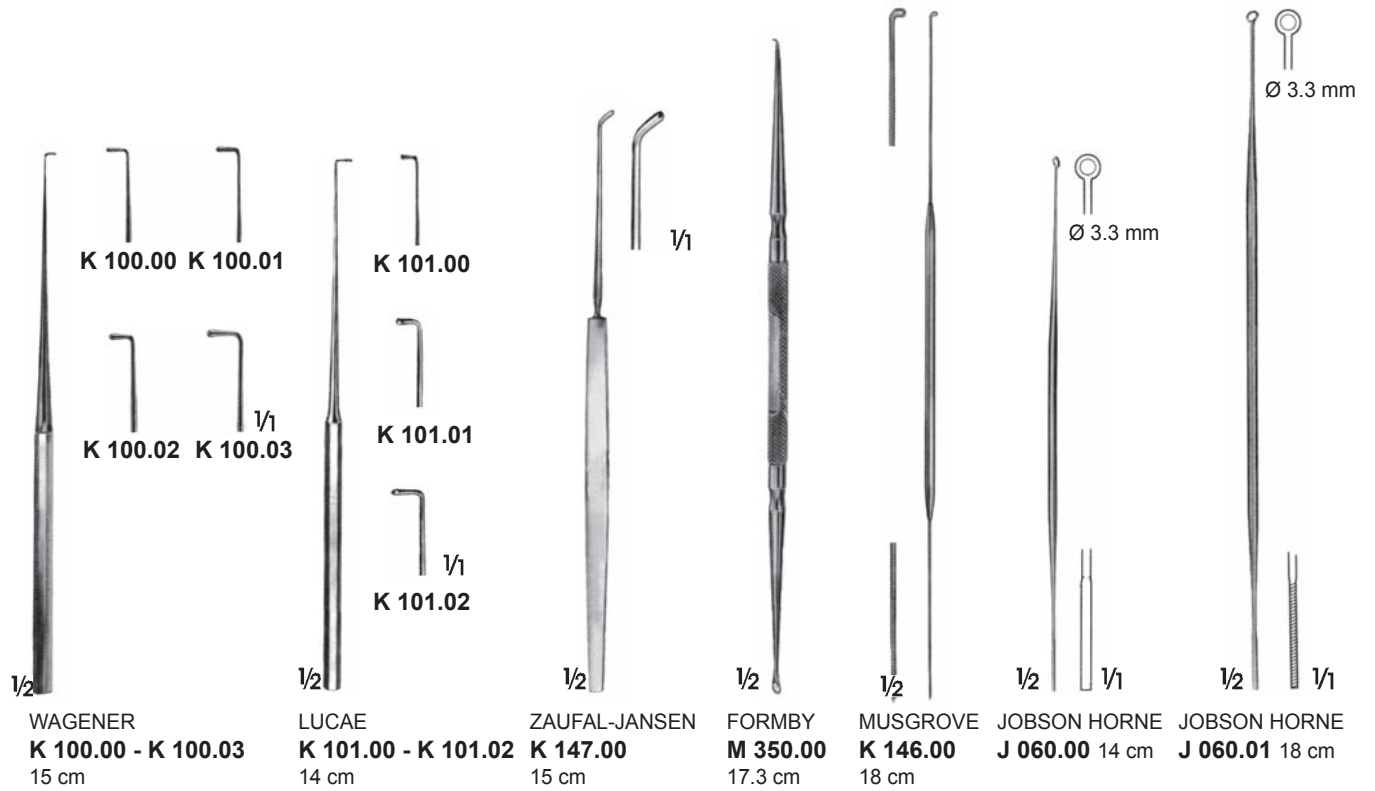

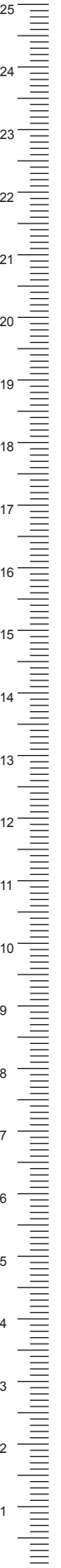
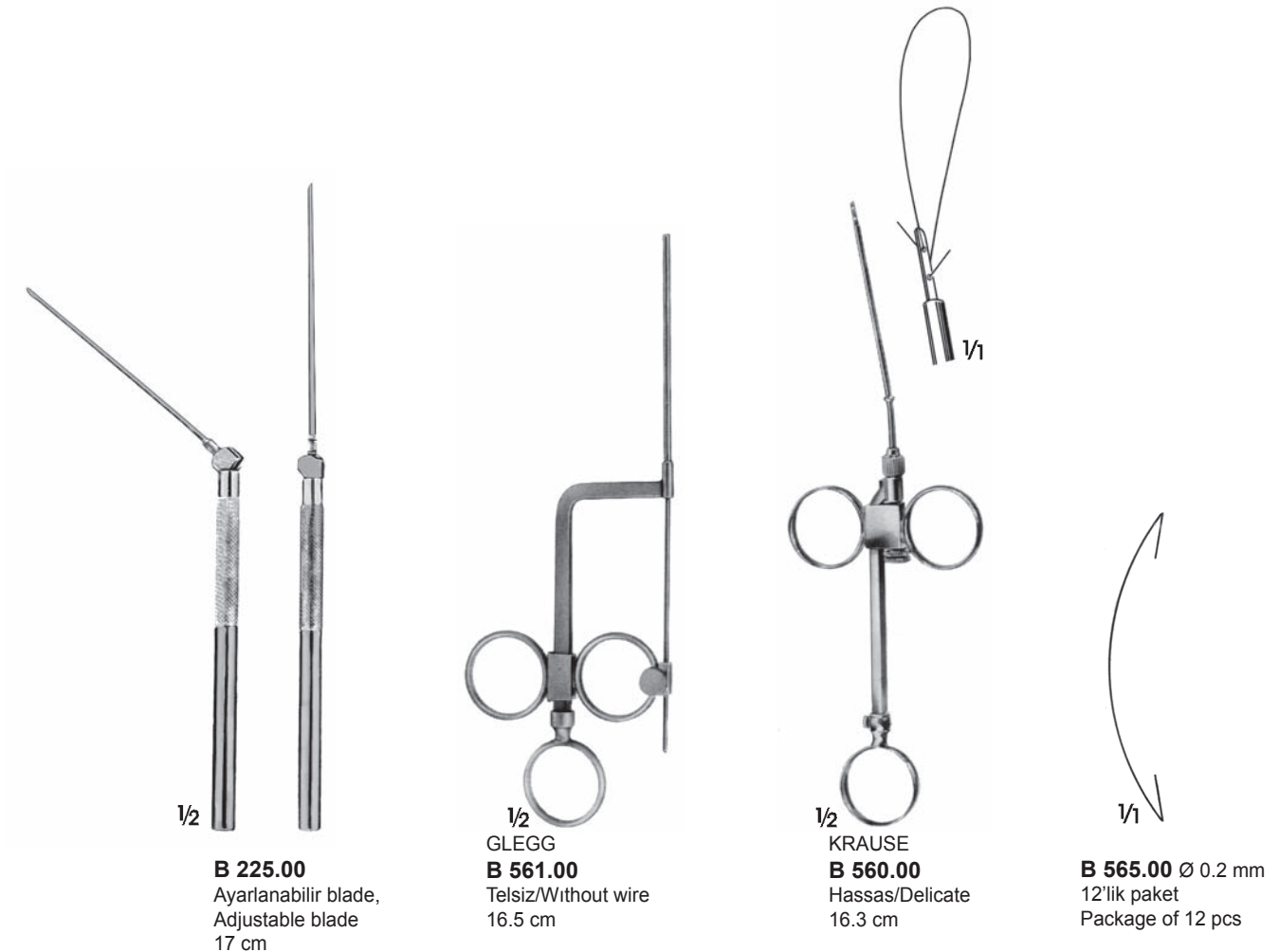
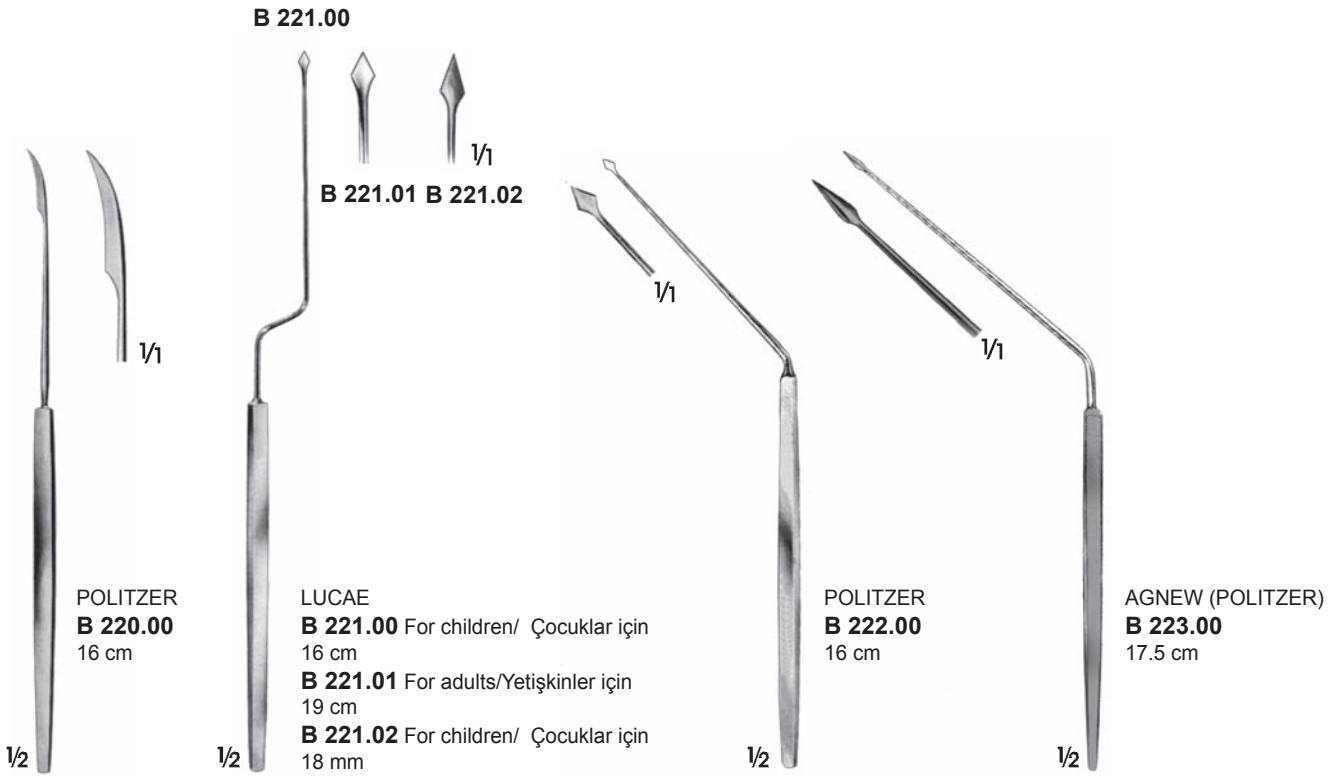



HARTMANN-WULLSTEIN
R 227.00 0.8 x 6 mm
Düz/Straight



HARTMANN
R 227.01 1 x 8 mm
Tırtıllı ağız, düz
Serrated jaws, straight

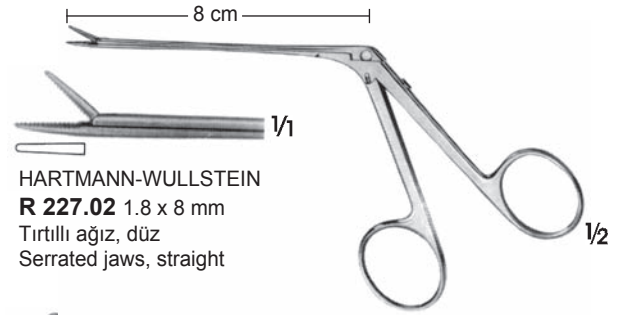

HARTMANN-WULLSTEIN
R 227.02 1.8 x 8 mm
Tırtıllı ağız, düz
Serrated jaws, straight



HARTMANN
R 226.01 Ø 2 mm
Düz/Straight



HARTMANN
R 226.02 Ø 2.5 mm
Düz/Straight



HARTMANN
R 226.03 Ø 3 mm
Düz/Straight



STRÜMPEL
R 260.00 2.5 x 5 mm
Yassı oval kaşık/Flat oval spoon



HARTMANN
R 228.00 2 x 6 mm
Tırtıllı ağız, düz
Serrated jaws, straight
1 x 2 Diş/1 x 2 Teeth



HARTMANN
R 229.00 Ø 2 x 7 mm
Oval, Düz/Oval, Straight



HARTMAN-WULLSTEIN
R 224.00 Ø 1 mm
Düz/Straight



HARTMAN-WULLSTEIN
R 224.01 Ø 2 mm
Düz/Straight



HARTMAN-CITELLI
R 225.00 Ø 2 mm
Yukarı açılı/Angled up

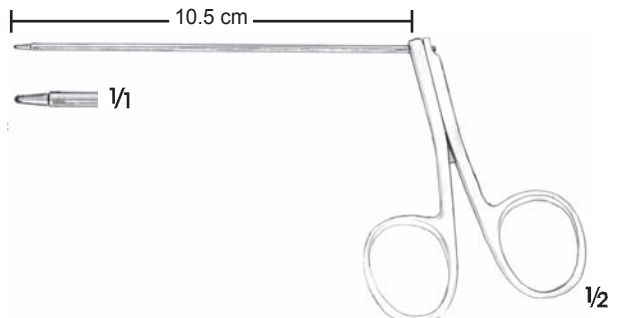

R 317.01
1.0 mm

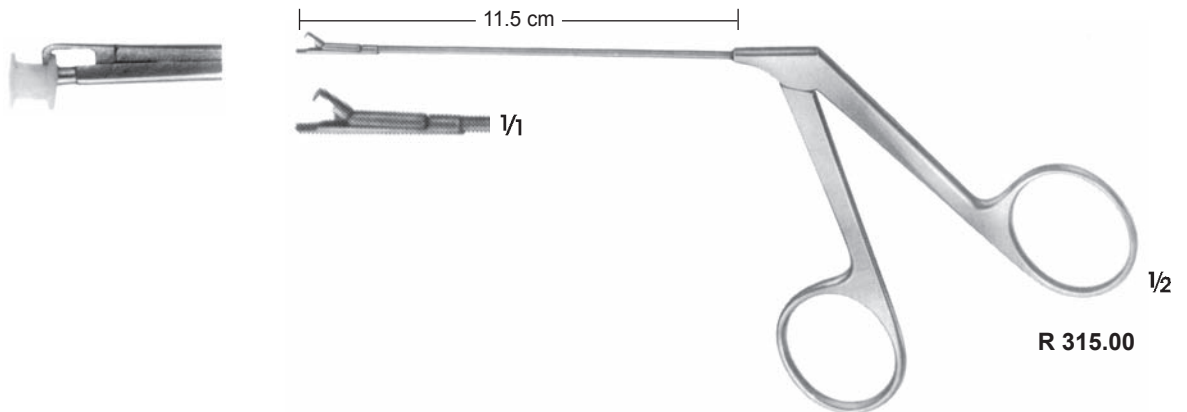

R 315.00

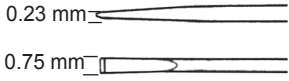

RONIS
M 056.01
Düz şaft/Straight Shaft
15 cm

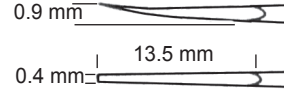

GOLDMAN
M 056.02
Düz şaft/Straight shaft
15 cm

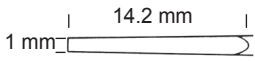

GOLDMAN
M 056.03
Düz şaft/Straight shaft
15 cm

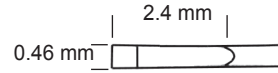

HOUSE
M 056.05
Düz şaft/Straight shaft
16.5 cm



HUGHES
M 056.06
Düz şaft/Straight shaft
16.5 cm

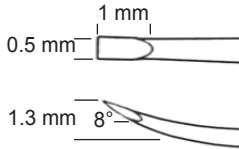

GUILFORD
M 057.00
6° şaft/ 6° shaft
14 cm

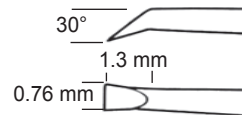

FARRIOR
M 057.01
30° şaft/30° shaft
15 cm

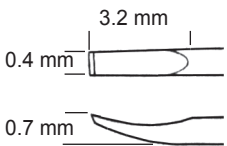

MCGEE
M 057.02
20° şaft/ 20° shaft
16 cm



GUILFORD
M 057.05
6° şaft/ 6° Shaft
14 cm

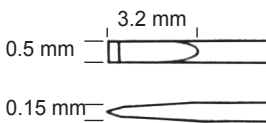

HOUGH
M 058.00
10° şaft/10° shaft
15 cm

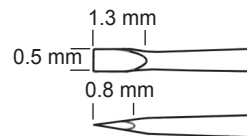

GUILFORD
M 058.01
6° şaft/6° shaft
14 cm



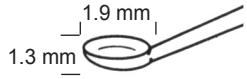
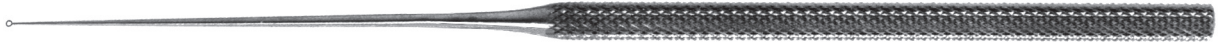

GUILFORD
N 052.01
Düz şaft/Straight Shaft
14 cm

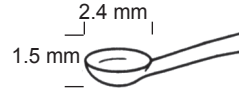

GUILFORD
N 052.02
Kazboynu şaft
Gooseneck shaft
14 cm

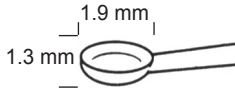

GUILFORD
N 052.04
Düz şaft/Straight Shaft
14 cm

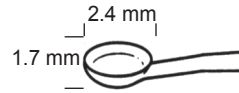

GUILFORD
N 052.05
Kazboynu şaft
Gooseneck shaft
14 cm

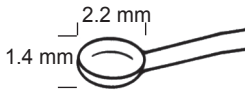

GUILFORD
N 052.06
Düz şaft/Straight shaft
14 cm

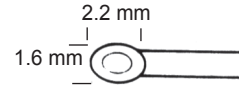

GOLDMAN
N 052.08
Düz şaft/Straight shaft
15 cm

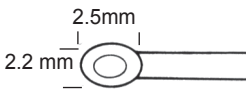

GOLDMAN
N 052.09
Düz şaft/Straight shaft
15 cm

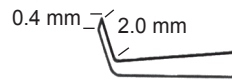

ANTOLI - CANDELA
N 052.12
Düz şaft/Straight shaft
16.5 cm

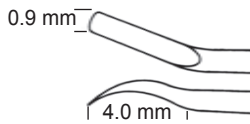

HOUGH
N 052.14
Düz şaft/Straight shaft
15 cm

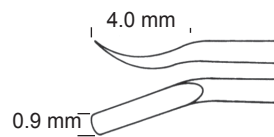

HOUGH
N 052.15
Düz şaft/Straight shaft
15 cm

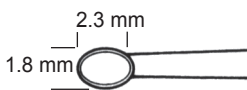

AUSTIN
N 053.01
10° şaft/10° Shaft
15 cm

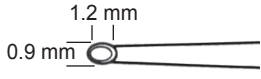
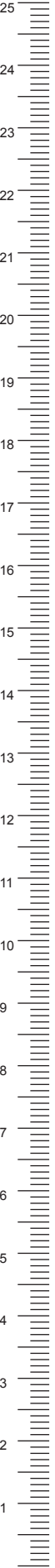

ANTOLI-CANDELA
N 054.01
Düz şaft/Straight shaft
15 cm

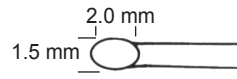

HOUGH
N 054.03
Düz şaft/Straight shaft
15 cm

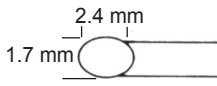

SCHEER
N 054.05
Düz şaft/Straight shaft
17 cm

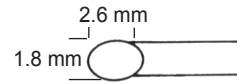

SCHEER
N 054.06
Düz şaft/Straight shaft
17 cm

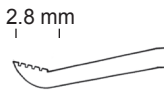

HOUGH
N 054.08
Düz şaft/Straight shaft
15 cm



ANTOLI-CANDELA
N 055.02
10° şaft/10° Shaft
15 cm

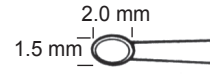

ANTOLI-CANDELA
N 055.03
10° şaft/10° Shaft
15 cm

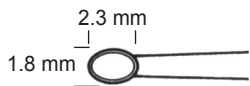

AUSTIN
N 055.04
10° şaft/10° Shaft
15 cm

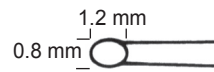

RONIS
N 055.05
10° şaft/10° Shaft
13 cm

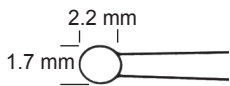

SHEA
N 055.07
10° şaft/10° Shaft
14.5 cm

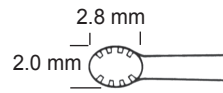

RONIS
N 055.08
Açılı şaft/Angled Shaft
13 cm

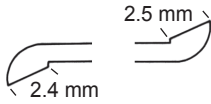

RICHARDS
N 056.01
Düz şaft/Straight shaft
18 cm

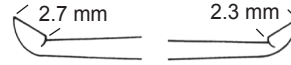

HAUSE-TYPE
N 056.03
Düz şaft/Straight shaft
16 cm

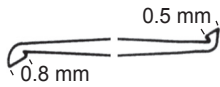

RUGGLES
N 057.01
12° şaft/12° shaft
17 cm

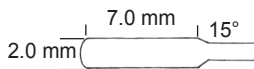

ANTOLI-CANDELA
M 050.00
Düz şaft/Straight shaft
16.5 cm

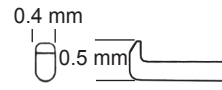

LIPPY
M 050.01
Düz şaft/Straight shaft
17 cm

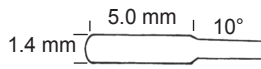

ANTOLI-CANDELA
M 050.02
Düz şaft/Straight shaft
16.5 cm

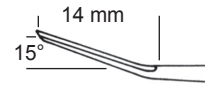

GUILFORD
M 050.05
Düz şaft/Straight shaft
14 cm

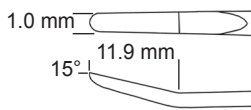

HOUSE-TYPE
M 050.06
Düz şaft/Straight shaft
16.5 cm

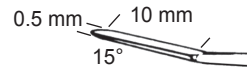

RONIS
M 050.07
Düz şaft/Straight shaft
15 cm

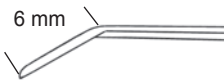

GUILFORD
M 050.08
Düz şaft/Straight shaft
14 cm

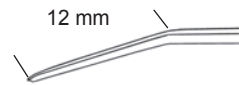

GUILFORD
M 050.09
Düz şaft/Straight shaft
16 cm

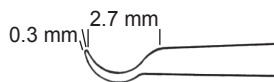

ANTOLI-CANDELA
M 050.12
Düz şaft/Straight shaft
16.5 cm

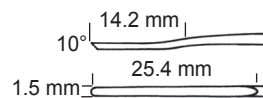

SHEA
M 050.15 Sağ/Right
M 050.16 Sol/Left
Düz şaft/Straight shaft
17 cm

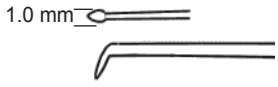
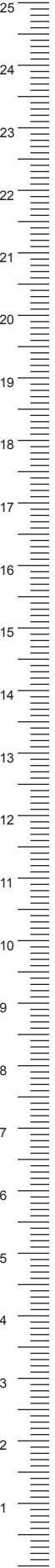

ROSEN
M 050.17
Düz şaft/Straight shaft
16 cm

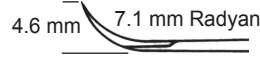

GINSBERG
M 050.18
Düz şaft/Straight shaft
15 cm

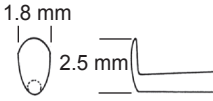

AUSTIN
M 050.19
Düz şaft/Straight shaft
16.5 cm

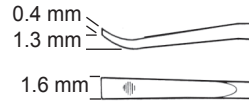

SCHEER
M 050.22
Düz şaft/Straight shaft
16 cm

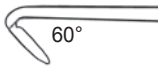

PLESTER
M 050.24
Düz şaft/Straight shaft
16 cm

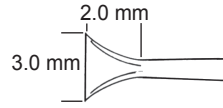

MCGEE
M 050.25
Düz şaft/Straight shaft
15.5 cm

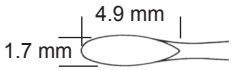

GUILFORD
M 050.26
Düz şaft/Straight shaft
14 cm

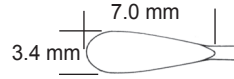

GUILFORD
M 050.27
Düz şaft/Straight shaft
14 cm

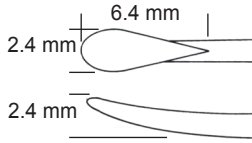

AUSTIN
M 050.28
Düz şaft/Straight shaft
16.5 cm

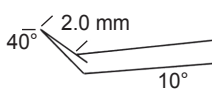

AUSTIN
M 051.01
40° şaft/40° shaft
16.5 cm

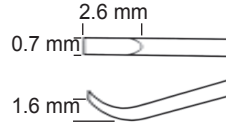

SCHUKNECHT
M 051.04
20° şaft/20° shaft
15.5 cm

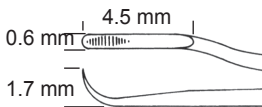

SCHUKNECHT
M 051.05 Sağ/Right
M 051.06 Sol/Left
20° şaft/20° shaft
15.5 cm

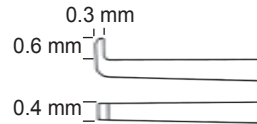

AUSTIN
M 051.08
10° şaft/10° shaft
16.5 cm

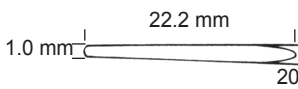

ANTOLI-CANDELA
M 051.10
20° şaft/20° shaft
16.5 cm

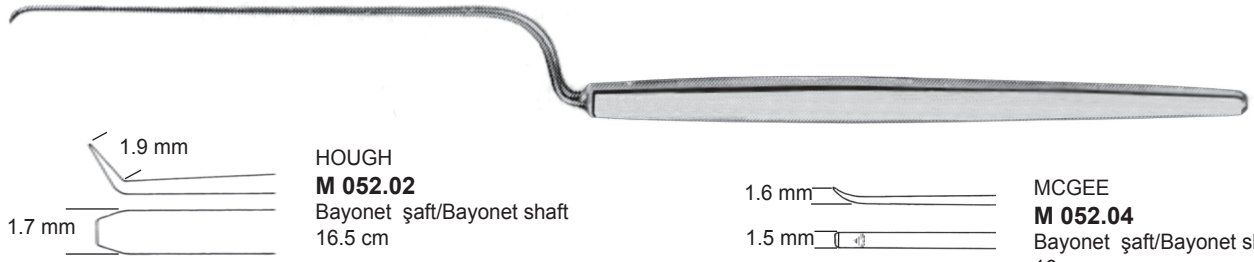

HOUGH
K 052.02
Bayonet şaft/Bayonet shaft
16.5 cm

MCGEE
M 052.04
Bayonet şaft/Bayonet shaft
16 cm

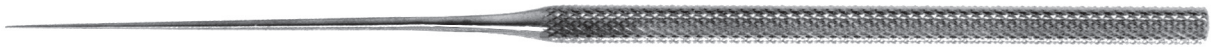

SHEA
K 057.00
Düz şaft/Straight shaft
17.5 cm

SHEA
K 057.01
Düz şaft/Straight shaft
17.5 cm

SHEA
K 057.02
Düz şaft/Straight shaft
17.5 cm

SHEA
K 057.03
Düz şaft/Straight shaft
17.5 cm

HOUSE-TYPE
K 057.04
Düz şaft/Straight shaft
16.5 cm

RONIS
K 057.06
Düz şaft/Straight shaft
15 cm

HOUSE-TYPE
K 057.07
Düz şaft/Straight shaft
16.5 cm

RONIS
K 057.08
Düz şaft/Straight shaft
15 cm

SCHEER
K 057.09
Düz şaft/Straight shaft
16 cm

SCHEER
K 057.10
Düz şaft/Straight shaft
16 cm

SCHEER
K 057.12
Düz şaft/Straight shaft
16 cm

SCHEER
K 057.13
Düz şaft/Straight shaft
16 cm

K 057.15
Düz şaft/Straight shaft
16 cm

PLESTER
K 057.17
Düz şaft/Straight shaft
16 cm

PLESTER
K 057.18
Düz şaft/Straight shaft
16 cm

PLESTER
K 057.20
Düz şaft/Straight shaft
16 cm

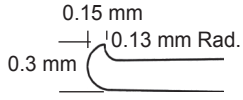

LIPPY
K 058.00 Öne doğru/Forward
K 058.02 Geriye doğru/Bacward
20° Şaft/20° Shaft
17 cm

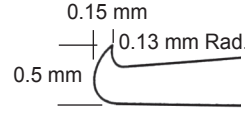

LIPPY
K 058.01 Öne doğru/Forward
K 058.03 Geriye doğru/Bacward
20° Şaft/20° Shaft
17 cm

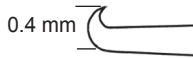

SCHUKNECHT
K 058.04 Yukarı doğru/Up ward
K 058.05 Aşağı doğru/Down ward
20° Şaft/20° Shaft
15.5 cm

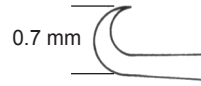

SCHUKNECHT
K 058.06 Aşağı doğru/Down ward
K 058.07 Yukarı doğru/Up ward
20° Şaft/20° Shaft
15.5 cm

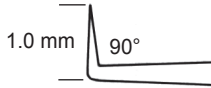

SCHUKNECHT
K 058.08
20° şaft/20° Shaft
15.5 cm

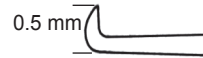

MCGEE
K 058.10 Geriye doğru/Bacward
K 058.11 Öne doğru/Forward
20° Şaft/20° Shaft
15.5 cm

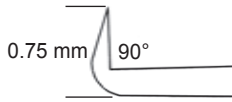

HAUSE-TYPE
K 058.12
90° şaft/90° Shaft
16.5 cm

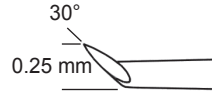

HAUSE-TYPE
K 058.16
30° şaft/30° Shaft
16.5 cm

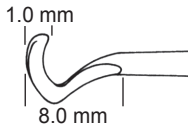

SHEA
M 055.00 Sağ/Right
M 055.01 Sol/Left
Düz şaft/Straight shaft
16.5 cm

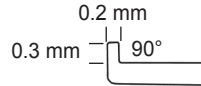

HOUSE
M 055.02
Düz şaft/Straight shaft
16.5 cm



M 055.04 Sağ/Right
M 055.05 Sol/Left
Düz şaft/Straight shaft
16 cm

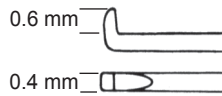

HOUGH
M 054.01
10° şaft/10° Shaft
15 cm

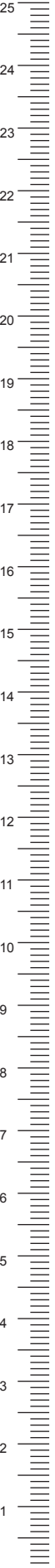

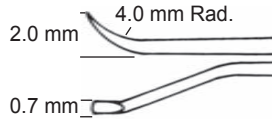

HOUGH
M 075.01 Sağ/Right
M 075.02 Sol/Left
Düz şaft/Straight shaft
15 cm

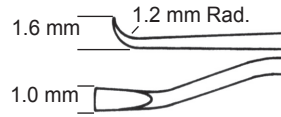

HOUGH
M 075.04 Sağ/Right
M 075.05 Sol/Left
Düz şaft/Straight shaft
15 cm

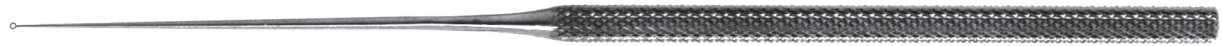

SCHEER
M 060.01
Düz şaft/Straight shaft
16 cm

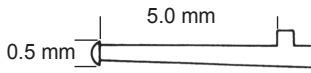

FARRIOR
M 061.01
30° şaft/30° Shaft
15 cm

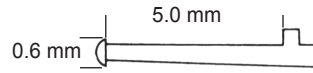

FARRIOR
M 061.02
30° şaft/30° Shaft
15 cm

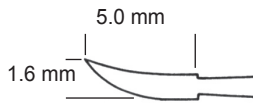

ANTOLI-CANDELA
B 080.00
Düz şaft/Straight shaft
16.5 cm

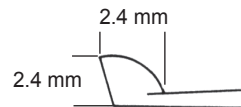

ANTOLI-CANDELA
B 080.01
Düz şaft/Straight shaft
16.5 cm

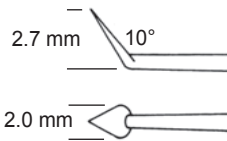

ANTOLI-CANDELA
B 080.02
Düz şaft/Straight shaft
16.5 cm

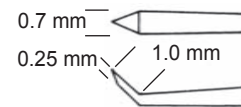

AUSTIN
B 080.03
Düz şaft/Straight shaft
16.5 cm

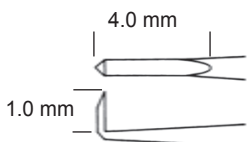

AUSTIN
B 080.04
Düz şaft/Straight shaft
16.5 cm

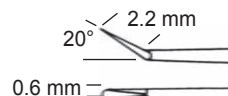

AUSTIN
B 080.05
Düz şaft/Straight shaft
16.5 cm

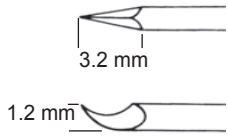

AUSTIN
B 080.06
Düz şaft/Straight shaft
16.5 cm

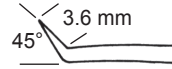

GOLDMAN
B 080.07
Düz şaft/Straight shaft
15 cm

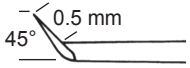

RONIS
B 080.08
Düz şaft/Straight shaft
15 cm

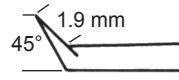

SCHEER
B 080.09
Düz şaft/Straight shaft
16 cm

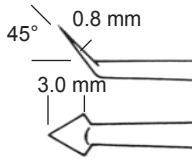

JORDAN
B 080.10
Düz şaft/Straight shaft
17.5 cm

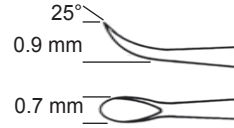

GUILFORD
B 080.11
Düz şaft/Straight shaft
14 cm



GUILFORD
B 080.13
Düz şaft/Straight shaft
14 cm

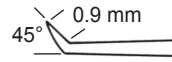

HARRISON
B 080.15
Düz şaft/Straight shaft
15.5 cm



HARRISON
B 080.17
Düz şaft/Straight shaft
15.5 cm

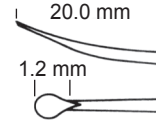

GUILFORD
B 080.18
Düz şaft/Straight shaft
14 cm

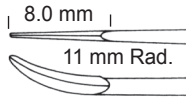

HOUSE-TYPE
B 080.20
Düz şaft/Straight shaft
16.5 cm

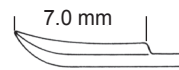

GUILFORD
B 080.22
Düz şaft/Straight shaft
14 cm



GUILFORD
B 080.23
Düz şaft/Straight shaft
14 cm

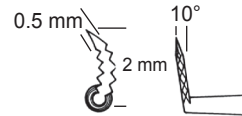

GUILFORD
B 080.24 10° sağ/10° right
B 080.25 10° sol/10° left
Düz şaft/Straight shaft
14 cm



HAUSE-TYPE
B 080.26
Düz şaft/Straight shaft
16 cm

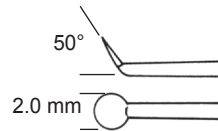

JORDAN
B 080.27
Düz şaft/Straight shaft
17.5 cm

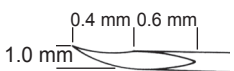

HOUGH
B 080.29
Düz şaft/Straight shaft
15 cm

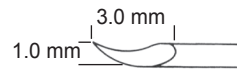

TABB
B 080.30
Düz şaft/Straight shaft
17 cm

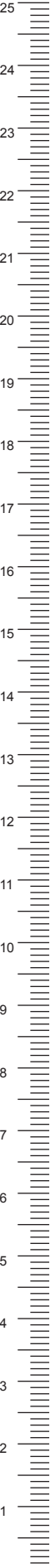

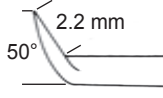

HOUGH
B 080.31
Düz şaft/Straight shaft
15 cm

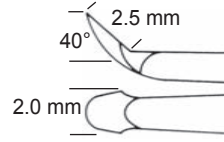

HAUSE-TYPE
B 080.32
Düz şaft/Straight shaft
16.5 cm



RONIS
B 080.34
Düz şaft/Straight shaft
15 cm

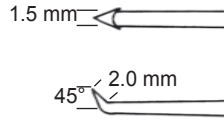

SHEA
B 080.35
Düz şaft/Straight shaft
17.5 cm



SCHEER
B 080.37
Düz şaft/Straight shaft
15 cm

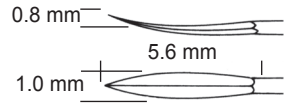

GUILFORD
B 080.38
Düz şaft/Straight shaft
14 cm



B 080.40
Düz şaft/Straight shaft
16 cm



B 080.41
Düz şaft/Straight shaft
16 cm



B 080.42
Düz şaft/Straight shaft
16 cm



B 080.43
Düz şaft/Straight shaft
16 cm

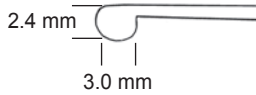

B 080.45
Düz şaft/Straight shaft
16 cm

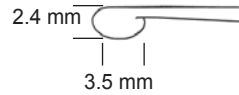

PLESTER
B 080.46
Düz şaft/Straight shaft
16 cm

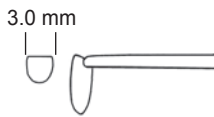

B 080.47
Düz şaft/Straight shaft
16 cm



B 080.49
Düz şaft/Straight shaft
16 cm

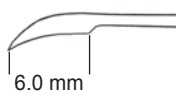

B 080.50
Düz şaft/Straight shaft
16 cm

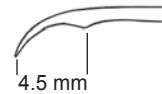

B 080.51
Düz şaft/Straight shaft
17 cm

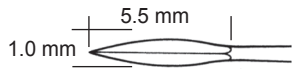

MCGEE
B 081.02
20° şaft/20° Shaft
15.5 cm



SHEA
B 081.05
10° şaft/10° Shaft
17.5 cm

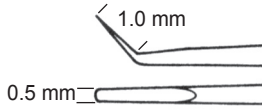

JORDAN
B 082.01
Bayonet şaft/Bayonet shaft
16.5 cm

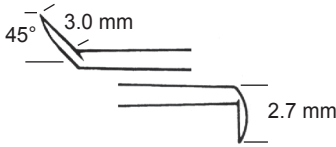

TABB
B 083.01
Düz şaft/Straight shaft
15 cm

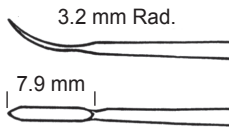

HOUSE-TYPE
B 084.01
Düz şaft/Straight shaft
16.5 cm

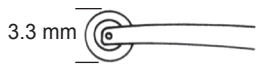

MCGEE
B 085.01
Düz şaft/Straight shaft
16 cm



MCGEE
B 085.03
Düz şaft/Straight shaft
16 cm

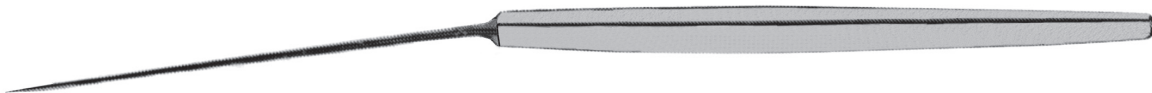

SCHUKNECHT
B 086.01
20° şaft/20° Shaft
16 cm



SCHUKNECHT
B 086.03
20° şaft/20° Shaft
16 cm

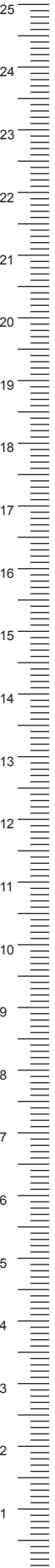

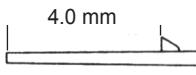

HAUSE-TYPE
T 050.01
Düz şaft/Straight shaft
16.5 cm

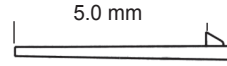

HAUSE-TYPE
T 050.02
Düz şaft/Straight shaft
16.5 cm

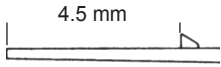

HAUSE-TYPE
T 050.03
Düz şaft/Straight shaft
16.5 cm

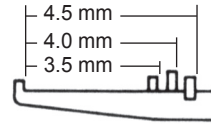

RICHARDS
T 050.05
Düz şaft/Straight shaft
17.5 cm

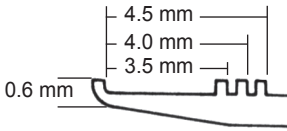

AUSTIN
T 050.06
Düz şaft/Straight shaft
17 cm

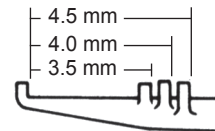

RONIS
T 050.07
Düz şaft/Straight shaft
15 cm

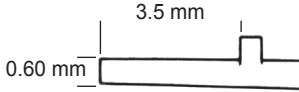

SCHUKNECHT
T 051.01
20° şaft/20° Shaft
15.5 cm

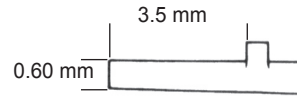

SCHUKNECHT
T 051.02
20° şaft/20° Shaft
15.5 cm

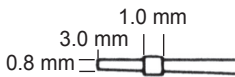

JORDAN
T 052.01
Bayonet şaft/Bayonet shaft
17 cm

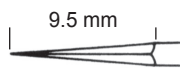

RONIS
V 052.00
Düz şaft/Straight shaft
15 cm

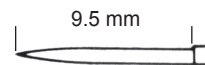

LARKIN
V 052.01
Düz şaft/Straight shaft
17 cm

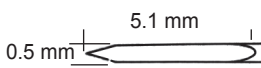

BUCKINGHAM
V 052.02
Düz şaft/Straight shaft
15 cm

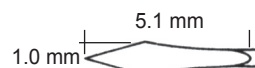

BUCKINGHAM
V 052.04
Düz şaft/Straight shaft
15 cm

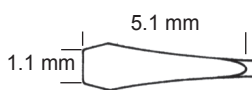

BUCKINGHAM
V 052.05
Düz şaft/Straight shaft
15 cm



1.5 mm		ANTOLI-CANDELA K 050.01 Düz şaft/Straight shaft 16.5 cm	3.0 mm		AUSTIN K 050.02 Düz şaft/Straight shaft 16.5 cm
0.3 mm		AUSTIN K 050.03 Düz şaft/Straight shaft 16.5 cm	1.1 mm		AUSTIN K 050.04 Düz şaft/Straight shaft 16.5 cm
0.7 mm		AUSTIN K 050.05 Düz şaft/Straight shaft 16.5 cm	1.4 mm		RONIS K 050.07 Düz şaft/Straight shaft 15 cm
0.8 mm		RONIS K 050.09 Düz şaft/Straight shaft 15 cm	1.0 mm		SCHEER K 050.10 Düz şaft/Straight shaft 16 cm
2.0 mm		GUILFORD K 050.11 Düz şaft/Straight shaft 14 cm	1.3 mm		SHEA K 050.12 Düz şaft/Straight shaft 17.5 cm
1.0 mm		SCHEER K 050.13 Düz şaft/Straight shaft 16 cm	1.0 mm 45°		GUILFORD K 050.15 Düz şaft/Straight shaft 14 cm
1.5 mm 45°		ANTOLI-CANDELA K 050.16 Düz şaft/Straight shaft 16.5 cm	1.6 mm 45°		GUILFORD K 050.17 Düz şaft/Straight shaft 14 cm
0.5 mm 45°		RONIS K 050.19 Düz şaft/Straight shaft 15 cm	0.8 mm 45°		ANTOLI-CANDELA K 050.20 Düz şaft/Straight shaft 16.5 cm
1.0 mm 45°		ANTOLI-CANDELA K 050.21 Düz şaft/Straight shaft 16.5 cm	1.0 mm 45°		RONIS K 050.22 Düz şaft/Straight shaft 15 cm
0.6 mm		SCHEER K 050.24 Düz şaft/Straight shaft 16 cm	0.3 mm		GOLDMAN K 050.25 Düz şaft/Straight shaft 15 cm
0.6 mm		GOLDMAN K 050.26 Düz şaft/Straight shaft 15 cm	1.1 mm		SCHEER K 050.27 Düz şaft/Straight shaft 16 cm

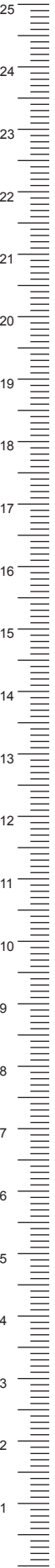

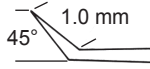

AUSTIN
K 050.28
Düz şaft/Straight shaft
16.5 cm

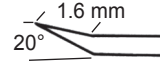

SCHEER
K 050.29
Düz şaft/Straight shaft
16 cm

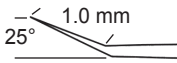

AUSTIN
K 050.30
Düz şaft/Straight shaft
16.5 cm

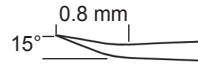

GUILFORD
K 050.32
Düz şaft/Straight shaft
14 cm



GUILFORD
K 050.33
Düz şaft/Straight shaft
14 cm



SCHEER
K 050.34
Düz şaft/Straight shaft
16 cm

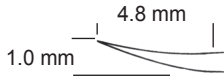

ANTOLI-CANDELA
K 050.35
Düz şaft/Straight shaft
16.5 cm

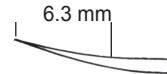

HOUGH
K 050.36
Düz şaft/Straight shaft
15 cm

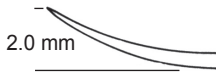

HOUSE-TYPE
K 050.37
Düz şaft/Straight shaft
16.5 cm

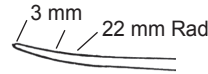

GOLDMAN
K 050.38 Künt/Blunt
K 050.39 Sivri/Sharp
Düz şaft/Straight shaft
15 cm



SCHEER
K 050.40
Düz şaft/Straight shaft
16 cm

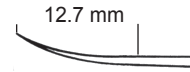

HOUGH
K 050.41
Düz şaft/Straight shaft
15 cm

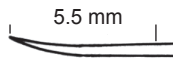

SHEA
K 050.42
Düz şaft/Straight shaft
16 cm



HOUSE-TYPE
K 050.43
Düz şaft/Straight shaft
16.5 cm



HOUSE-TYPE
K 050.45
Düz şaft/Straight shaft
16.5 cm

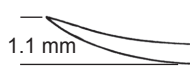

AUSTIN
K 050.46
Düz şaft/Straight shaft
16.5 cm

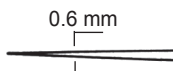

RONIS
K 050.48
Düz şaft/Straight shaft
15 cm

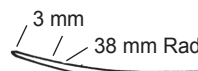

GOLDMAN
K 050.52 Künt/Blunt
K 050.53 Sivri/Sharp
Düz şaft/Straight shaft
15 cm

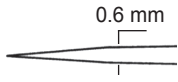
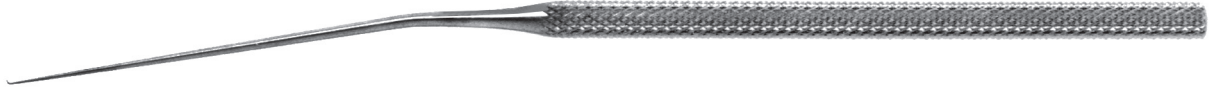

0.6 mm
MCGEE
K 054.00
20° şaft/20° shaft
15.5 cm

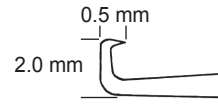

0.5 mm
ADIN
K 054.01
20° şaft/20° shaft
15.5 cm

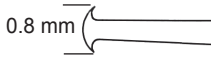

0.8 mm
MCGEE-FARRIOR
K 054.02
20° şaft/20° shaft
16 cm



0.5 mm
MCGEE-FARRIOR
K 054.03
20° şaft/20° shaft
16 cm

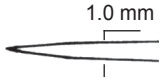

1.0 mm
SCHUKNECHT
K 054.05
20° şaft/20° shaft
15.5 cm



0.3 mm
HOUGH
K 054.07
15° şaft/15° shaft
15 cm

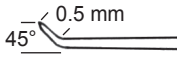

0.5 mm
HOUGH
K 054.08
10° şaft/10° shaft
15 cm

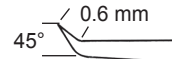

0.6 mm
FARRIOR
K 054.09 Sağ/Right
K 054.10 Sol/Left
45° şaft/45° shaft
15.5 cm

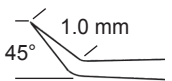

1.0 mm
GUILFORD
K 054.11 Yukarı /Up
K 054.12 Aşağı/Down
6° şaft/6° shaft
14 cm

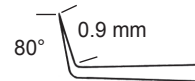

0.9 mm
MCGEE
K 054.13
20° şaft/20° shaft
16 cm



0.6 mm
FARRIOR
K 054.14 Yukarı /Up
K 054.15 Aşağı/Down
30° şaft/30° shaft
15.5 cm

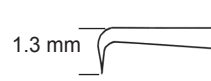

ANTOLI-CANDELA
K 054.16 Aşağı sağ/Down right
K 054.17 Aşağı sol/Down left
10° şaft/10° shaft
16.5 cm



0.8 mm
GUILFORD
K 054.18 Sağ/Right
K 054.19 Sol/Left
6° şaft/6° shaft
14 cm

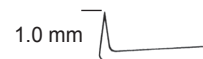

GUILFORD
K 054.20 Sağ/Right
K 054.21 Sol/Left
6° şaft/6° shaft
14 cm



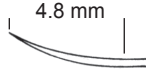

JORDAN
K 061.01 Yukarı doğru/Up ward
K 061.02 Aşağı doğru/Down ward
Bayonet şaft/Bayonet shaft
16.5 cm

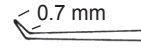

JORDAN
K 061.04
Bayonet şaft/Bayonet shaft
16.5 cm



JORDAN
K 061.06 Yukarı/Up
K 061.07 Aşağı/Down
K 061.08 Sol/Left
Bayonet şaft/Bayonet shaft
16.5 cm

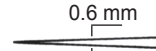

JORDAN
K 061.10
Bayonet şaft/Bayonet shaft
16.5 cm

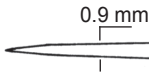

JORDAN
K 061.11
Bayonet şaft/Bayonet shaft
16.5 cm

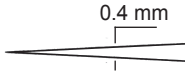

HOUSE-TYPE
K 062.01
Düz şaft/Straight shaft
16.5 cm

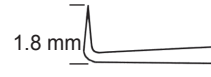

HOUSE-TYPE
K 062.03
Düz şaft/Straight shaft
16.5 cm



HOUSE-TYPE
K 062.05
Düz şaft/Straight shaft
16 cm

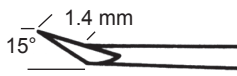

RONIS
M 062.01
Düz şaft/Straight shaft
15 cm

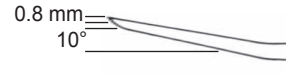

MCGEE
M 062.03
Düz şaft/Straight shaft
15.5 cm



M 062.04
Düz şaft/Straight shaft
16 cm

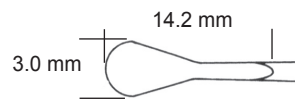

GOLDMAN
M 062.05
Düz şaft/Straight shaft
15 cm

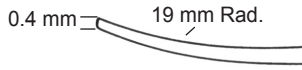
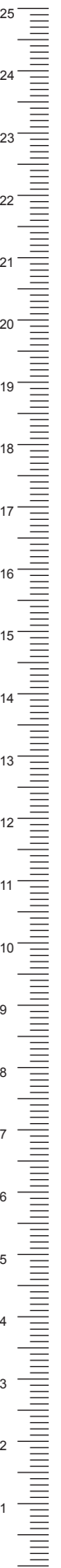

HOUSE-TYPE
M 065.01
Bayonet şaft/Bayonet shaft
16.5 cm

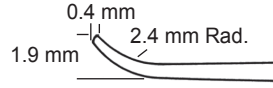

HOUSE-TYPE
M 065.02
Bayonet şaft/Bayonet shaft
16.5 cm

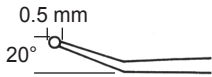

GOLDMAN
J 001.01
Düz şaft/Straight shaft
15 cm

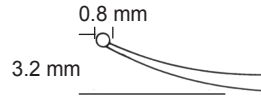

GOLDMAN
J 001.02
Düz şaft/Straight shaft
15 cm

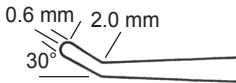

ANTOLI-CANDELA
J 001.04
Düz şaft/Straight shaft
16.5 cm

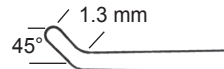

AUSTIN
J 001.05
Düz şaft/Straight shaft
17 cm

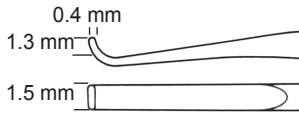

HOUGH
M 070.01
Düz şaft/Straight shaft
15 cm



SCHUKNECHT
M 071.01
20° şaft/20° Shaft
15.5 cm

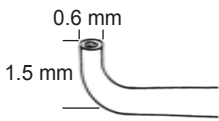

COYLE
J 003.01
Düz şaft/Straight shaft
17 cm

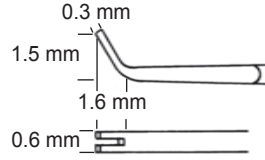

DUBERSTEIN
J 004.01
Düz şaft/Straight shaft
16 cm

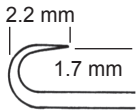

GOLDMAN
K 060.01
Düz şaft/Straight shaft
15 cm

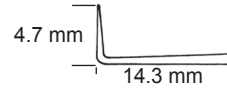

AUSTIN
M 080.01
Düz şaft/Straight shaft
16.5 cm

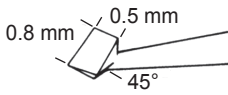

GOLDMAN
M 080.02
Düz şaft/Straight shaft
15 cm

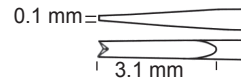

HOUSE-TYPE
M 072.01
Düz şaft/Straight shaft
15 cm

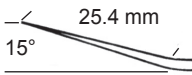

ANTOLI-CANDELA
V 050.00
Düz şaft/Straight shaft
16.5 cm

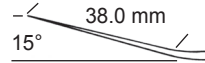

ANTOLI-CANDELA
V 050.01
Düz şaft/Straight shaft
16.5 cm



HOUSE-TYPE
V 051.00
Düz şaft/Straight shaft
16.5 cm



HOUSE-TYPE
V 051.01
Düz şaft/Straight shaft
16.5 cm

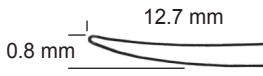

HOUSE-TYPE
V 051.03
Düz şaft/Straight shaft
15 cm

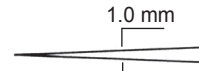

SCHEER
V 051.05
Düz şaft/Straight shaft
16 cm



SCHEER
V 051.07
Düz şaft/Straight shaft
16 cm

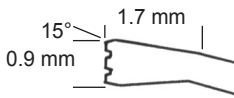

HOUGH
M 081.01
10° şaft/10° Shaft
15 cm

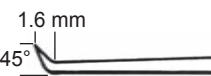

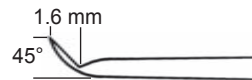

SHEEHY
V 053.01
Düz şaft/Straight shaft
16 cm



SHEEHY
V 053.02
Düz şaft/Straight shaft
16 cm



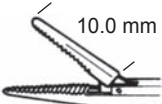
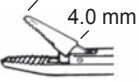
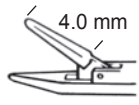
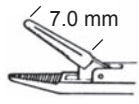
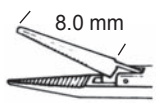
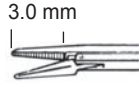
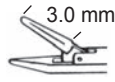
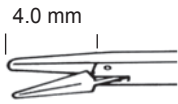
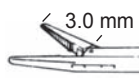
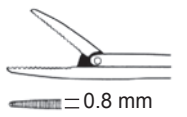
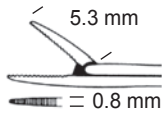
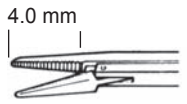
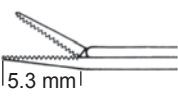

	HARTMAN R 052.01 Düz şaft/Straight shaft 8 cm		HARTMAN R 052.05 Düz şaft/Straight shaft 8 cm
	HARTMAN R 052.02 Düz şaft/Straight shaft 8 cm		RICHARDS R 052.11 Düz şaft/Straight shaft 8 cm
	HARTMAN R 052.03 Düz şaft/Straight shaft 8 cm		HARTMANN R 052.14 Düz şaft/Straight shaft 8 cm
	HARTMAN R 052.04 Düz şaft/Straight shaft 8 cm		HARTMAN R 052.18 Düz şaft/Straight shaft 8 cm
	RICHARDS R 052.10 Düz şaft/Straight shaft 8 cm		RICHARDS R 052.20 Düz şaft/Straight shaft 8 cm
	HARTMANN R 052.13 Düz şaft/Straight shaft 8 cm		RICHARDS R 052.22 Düz şaft/Straight shaft 8 cm
	RICHARDS R 052.16 Düz şaft/Straight shaft 8 cm		RICHARDS R 052.23 Düz şaft/Straight shaft 8 cm
	HARTMAN R 052.19 Düz şaft/Straight shaft 8 cm		RICHARDS R 052.24 Düz şaft/Straight shaft 8 cm
			RICHARDS R 052.25 Düz şaft/Straight shaft 8 cm



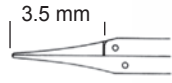

MCGEE
R 052.26
8 cm

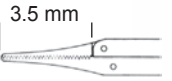

MCGEE
R 052.27
8 cm

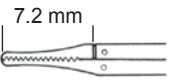

RICHARDS
R 052.28
Düz şaft/Straight shaft
8 cm



HARTMANN
R 052.30
Düz şaft/Straight shaft
8 cm

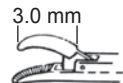

HARTMANN
R 052.33
Düz şaft/Straight shaft
8 cm

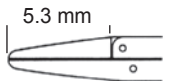

RICHARDS
R 052.36
8 cm

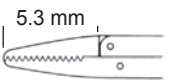

RICHARDS
R 052.38
8 cm

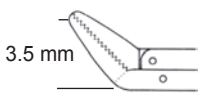

RICHARDS
R 052.40
Yukarı eğri/Curved upwards
Düz şaft/Straight shaft
8 cm

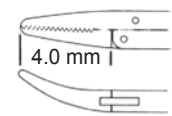

RICHARDS
R 052.43
Sağa eğri/Curved right
Düz şaft/Straight shaft
8 cm

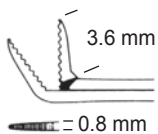

RICHARDS
R 052.45
Düz şaft/Straight shaft
8 cm

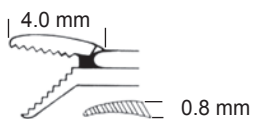

RICHARDS
R 052.47 Sol uclu/Left tip
Düz şaft/Straight shaft
8 cm

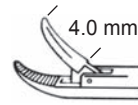

HARTMANN
R 052.31
Düz şaft/Straight shaft
8 cm

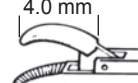

HARTMANN
R 052.34
Düz şaft/Straight shaft
8 cm

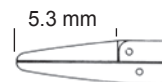

RICHARDS
R 052.37
Düz şaft/Straight shaft
8 cm

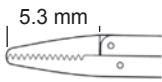

RICHARDS
R 052.39
8 cm

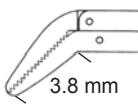

RICHARDS
R 052.41
Aşağı eğri/Curved downwards
Düz şaft/Straight shaft
8 cm

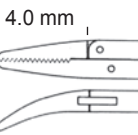

RICHARDS
R 052.44
Sola eğri/Curved left
Düz şaft/Straight shaft
8 cm

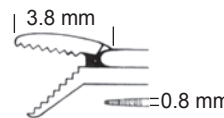

RICHARDS
R 052.46
Düz şaft/Straight shaft
8 cm

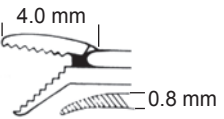

RICHARDS
R 052.48 Sağ uclu/Right tip
Düz şaft/Straight shaft
8 cm





25
24
23
22
21
20
19
18
17
16
15
14
13
12
11
10
9
8
7
6
5
4
3
2
1

3.0 mm
SHEA
R 053.00
Düz şaft/Straight shaft
8 cm

4.0 mm
SHEA
R 053.01
Düz şaft/Straight shaft
8 cm

3.0 mm
SHEA
R 053.03
Düz şaft/Straight shaft
8 cm

4.0 mm
SHEA
R 053.04
Düz şaft/Straight shaft
8 cm

3.0 mm
SHEA
R 053.06
Düz şaft/Straight shaft
8 cm

4.0 mm
SHEA
R 053.07
Düz şaft/Straight shaft
8 cm

3.0 mm
SHEA
R 053.09
Düz şaft/Straight shaft
8 cm

4.0 mm
SHEA
R 053.10
Düz şaft/Straight shaft
8 cm

1.3 mm
0.8 mm
RICHARDS
R 053.12
Uzun şaft/X long
8 cm

4.7 mm
RICHARDS
R 053.15
Düz şaft/Straight shaft
8 cm

3.7 mm
RICHARDS
R 053.16
Yukarı eğri/Curved upwards
Düz şaft/Straight shaft
8 cm

3.9 mm
RICHARDS
R 053.17
Aşağı eğri/ Curved downwards
Düz şaft/Straight shaft
8 cm

4.0 mm
RICHARDS
R 053.18
Sola eğri/Curved left
Düz şaft/Straight shaft
8 cm

4.0 mm
RICHARDS
R 053.19
Sağa eğri/Curved right
Düz şaft/Straight shaft
8 cm

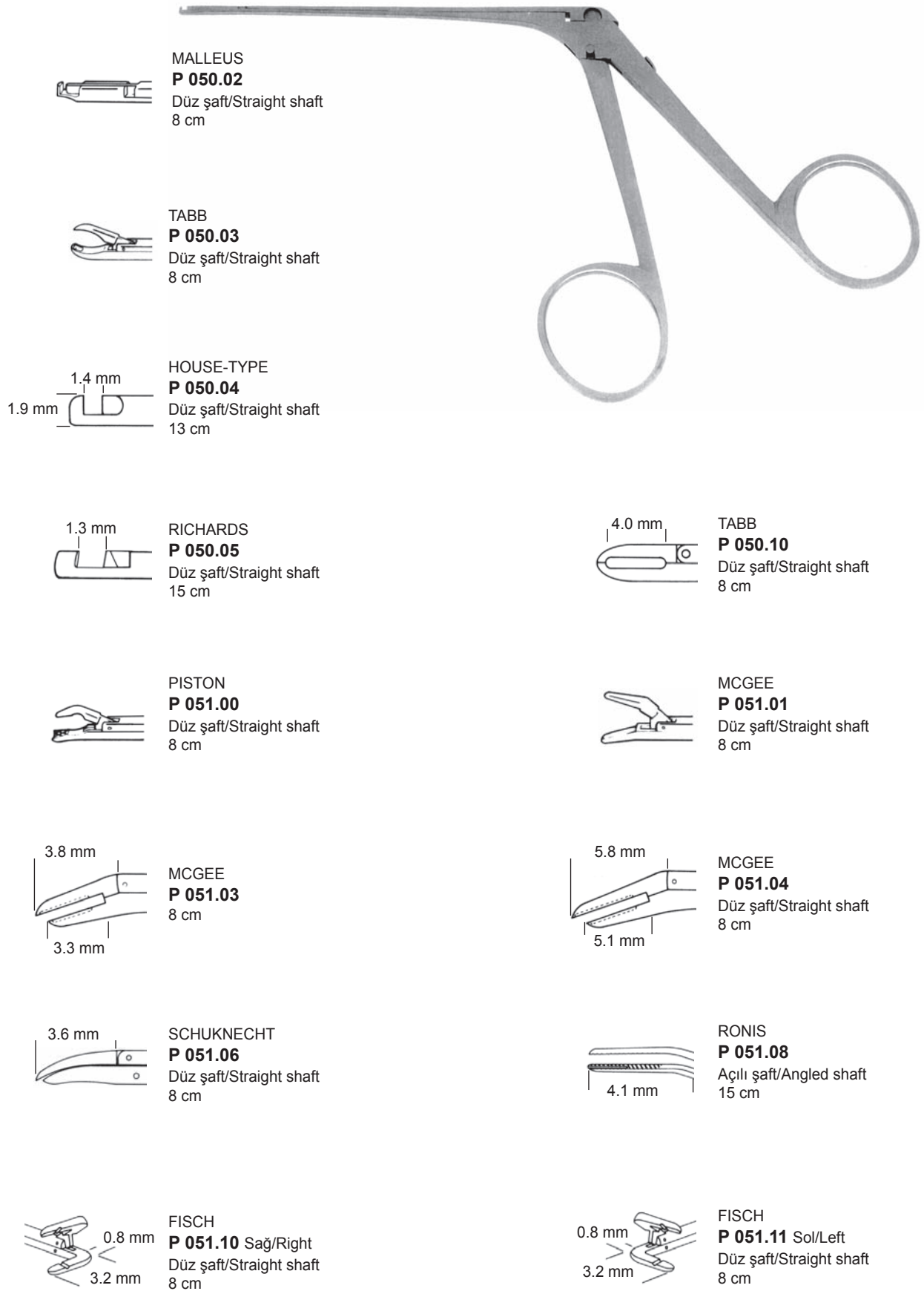

MALLEUS
P 050.02
Düz şaft/Straight shaft
8 cm

TABB
P 050.03
Düz şaft/Straight shaft
8 cm

HOUSE-TYPE
P 050.04
Düz şaft/Straight shaft
13 cm

RICHARDS
P 050.05
Düz şaft/Straight shaft
15 cm

TABB
P 050.10
Düz şaft/Straight shaft
8 cm

PISTON
P 051.00
Düz şaft/Straight shaft
8 cm

MCGEE
P 051.01
Düz şaft/Straight shaft
8 cm

MCGEE
P 051.03
8 cm

MCGEE
P 051.04
Düz şaft/Straight shaft
8 cm

SCHUKNECHT
P 051.06
Düz şaft/Straight shaft
8 cm

RONIS
P 051.08
Açılı şaft/Angled shaft
15 cm

FISCH
P 051.10 Sağ/Right
Düz şaft/Straight shaft
8 cm

FISCH
P 051.11 Sol/Left
Düz şaft/Straight shaft
8 cm

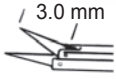
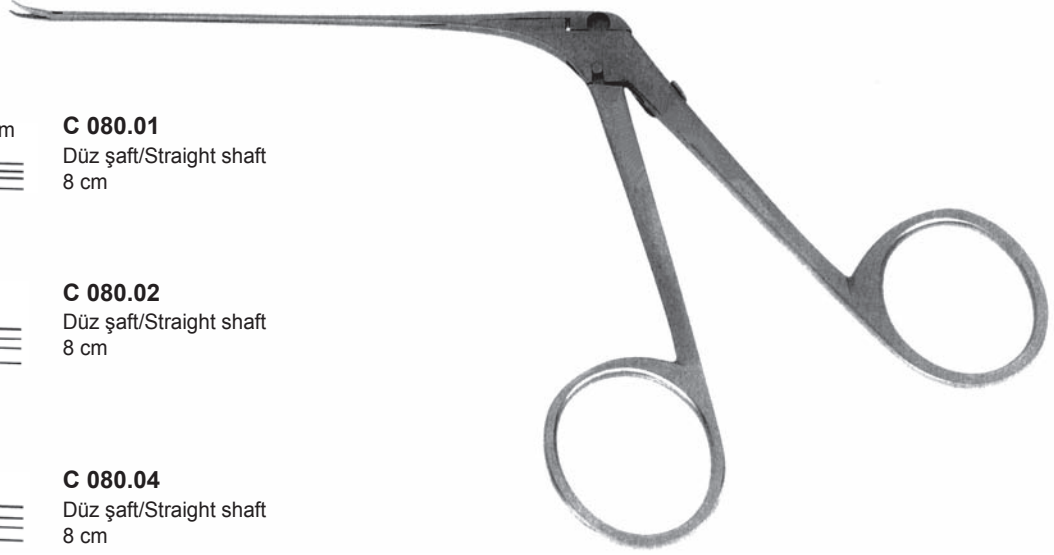
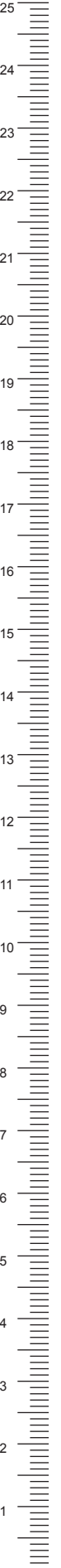

C 080.01
Düz şaft/Straight shaft
8 cm

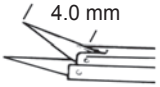

C 080.02
Düz şaft/Straight shaft
8 cm

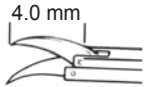

C 080.04
Düz şaft/Straight shaft
8 cm

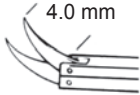

C 080.05
Düz şaft/Straight shaft
8 cm

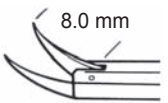

SHEA
C 080.07
Düz şaft/Straight shaft
8 cm

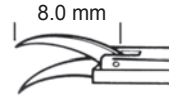

SHEA
C 080.06
Düz şaft/Straight shaft
8 cm

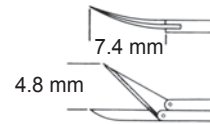

SHEA
C 080.10 Sağ/Right
C 080.11 Sol/Left
Düz şaft/Straight shaft
8 cm

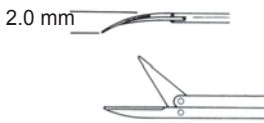

RICHARDS
C 080.13 Sağ/Right
C 080.14 Sol/Left
Düz şaft/Straight shaft
8 cm

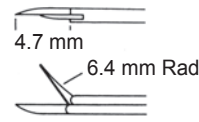

MCGEE
C 080.15
Düz şaft/Straight shaft
8 cm

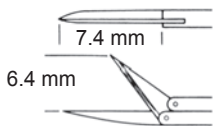

SHEA
C 080.16
8 cm

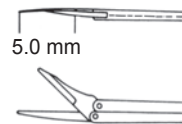

RICHARDS
C 080.17
Düz şaft/Straight shaft
8 cm



M 380.15
M 380.00 - M 380.04
aletleri için sap
Handle to hold instruments
M 380.00 - M 380.04

1/1



HEERMANN
M 380.00 - M 380.04
9 cm

1/2



M 380.00
0.7 mm



M 380.01
0.7 mm



M 380.02
1.0 mm



M 380.03
1.5 mm



M 380.04
3.0 mm

1/1



MANN
T 201.00

1/2

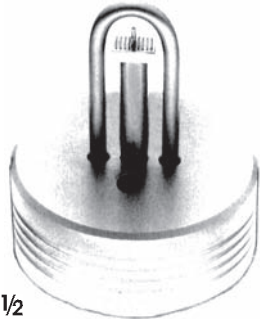

SCHUKNECHT
T 202.00

1/2



T 200.00
Damar presi
Vein press
12 cm



M 810.01
16.5 cm

1/2

Ø 22 mm



HEERMANN
M 380.10
19.5 cm

1/2



1/1



1/2

BECKMANN
L 263.00
Yana doğru eğri
Curved sideways
15 cm

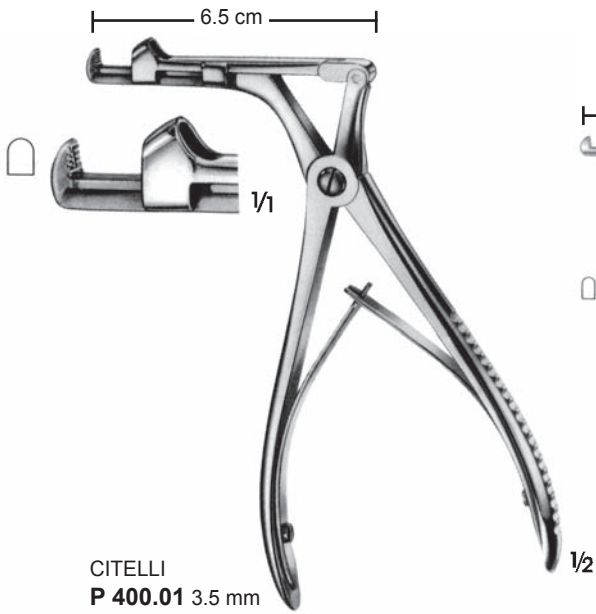

CITELLI
P 400.01 3.5 mm

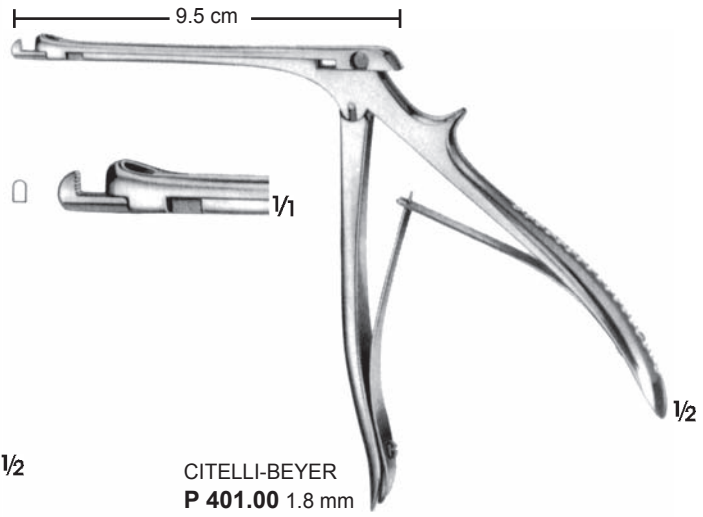

CITELLI-BEYER
P 401.00 1.8 mm



P 405.00 4 mm



P 405.01 5 mm

KERRISON
P 405.00 - P 405.01





Rinoplasti - Rinoloji
Rhinology - Rhinoplasty



TIECK-HALLE
L 260.00 - L 260.01
Çocuklar için/For children
13.5 cm



L 260.00 L 260.01

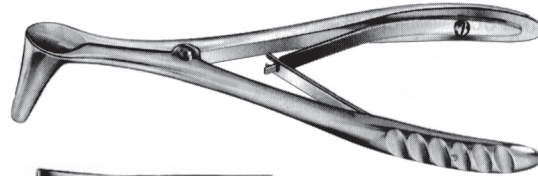

WIENER MODELL
L 268.00
14 cm

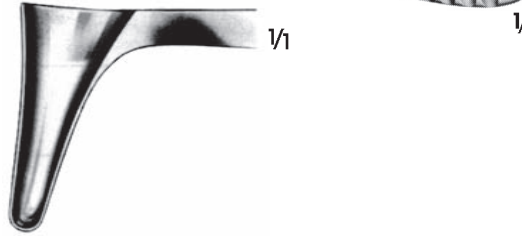

WIENER MODELL
L 268.02
14 cm

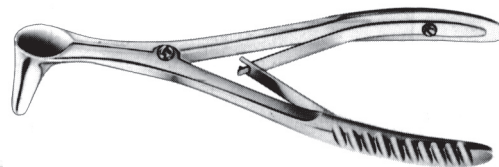
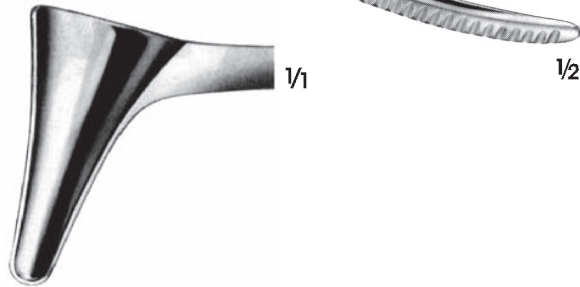

WIENER MODELL
L 269.00
14 cm

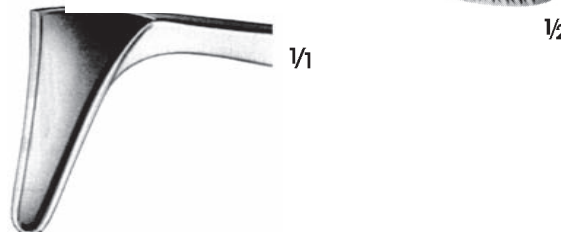

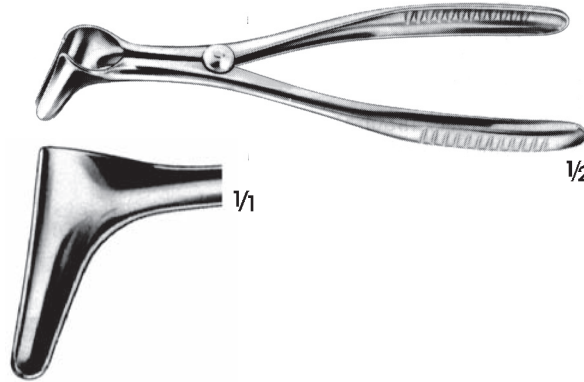

HARTMANN
L 270.00
14.5 cm

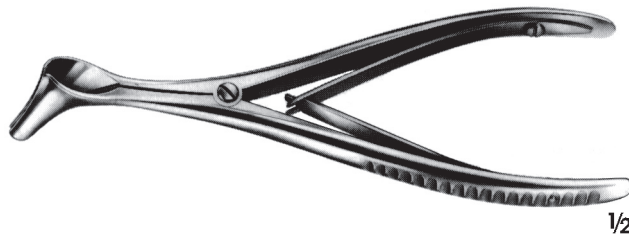

HARTMANN
L 271.00 - L 271.02
16 cm

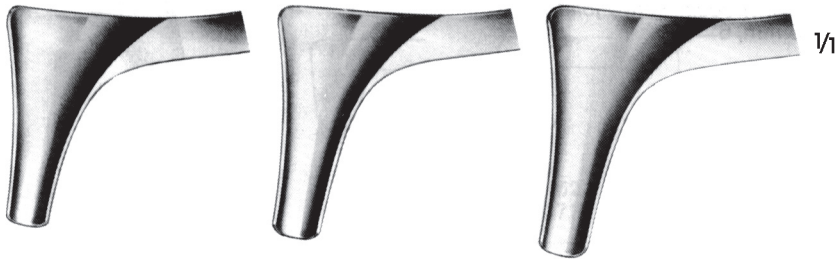

L 271.00

L 271.01

L 271.02

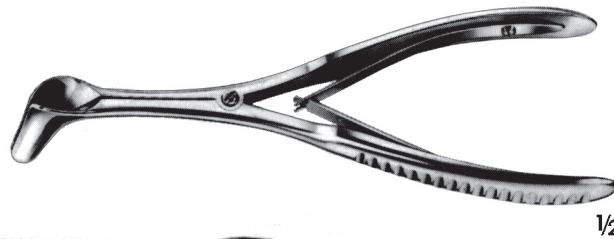

HARTMANN-HALLE
L 266.00 - L 266.02
15.5 cm

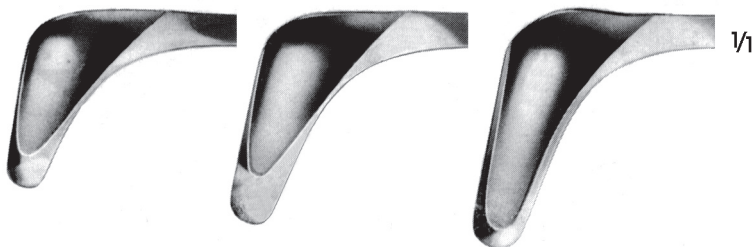

L 266.00

L 266.01

L 266.02

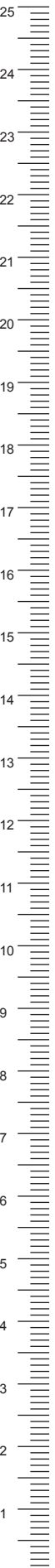



BECKMANN
L 264.00
Çocuklar için/For children
Yanadoğru eğri/Curved sidewards
14 cm



BECKMANN
L 263.00
Yanadoğru eğri/Curved sidewards
15 cm

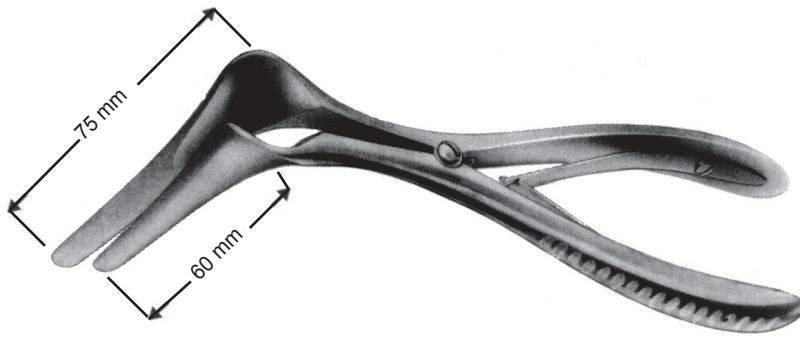

L 280.00
Kısa sol bleyd,
Left blade shortened

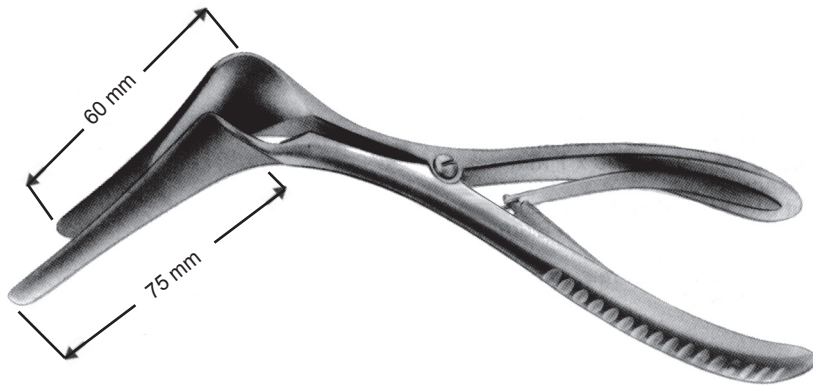

L 280.01
Kısa sağ bleyd,
Right blade shortened



COTTLE
L 276.00 - L 276.03
13.5 cm

L 276.00
35 x 7 mm



L 276.01
55 x 7 mm



L 276.02
76 x 7 mm



L 276.03
90 x 7 mm



COTTLE
L 277.00 - L 277.03
13.5 cm

L 277.00
35 x 7 mm

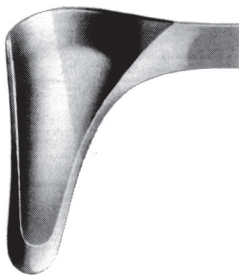

L 277.01
55 x 7 mm

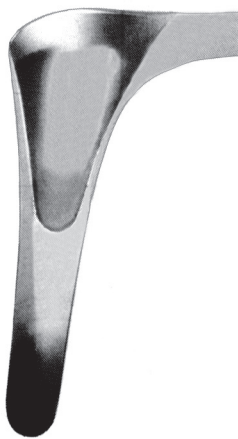

L 277.02
76 x 7 mm



L 277.03
90 x 7 mm

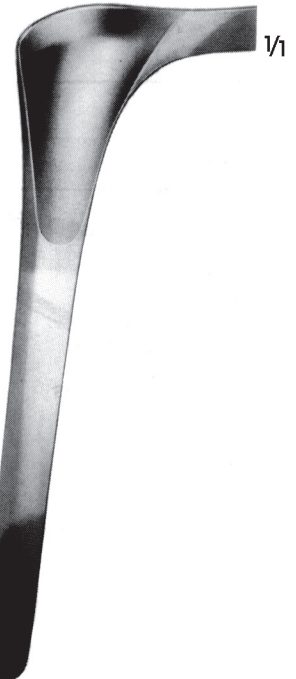



HARTMANN
E 280.01
17.5 cm

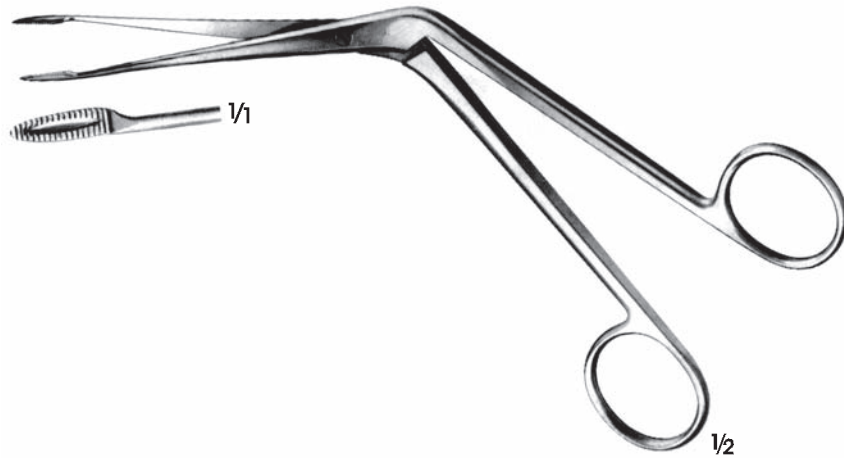

HARTMANN
E 281.01
21.5 cm

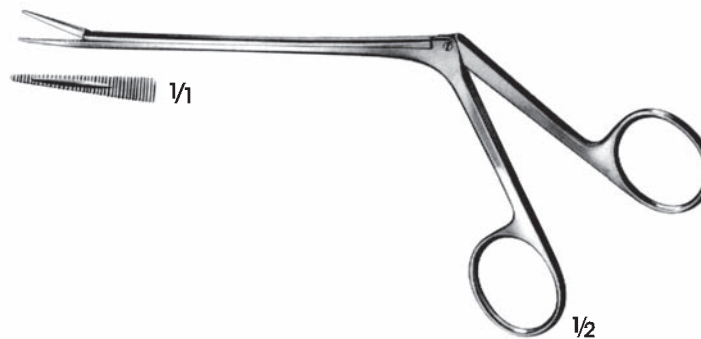

HARTMANN
E 283.01
19 cm

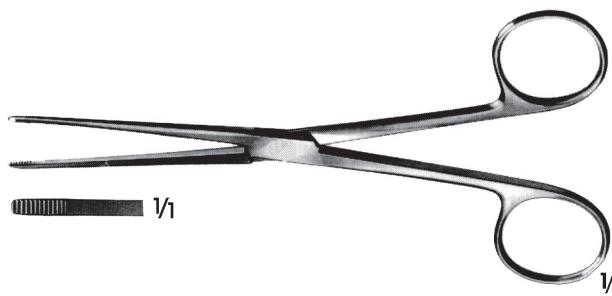

LISTER
E 007.00
15.5 cm

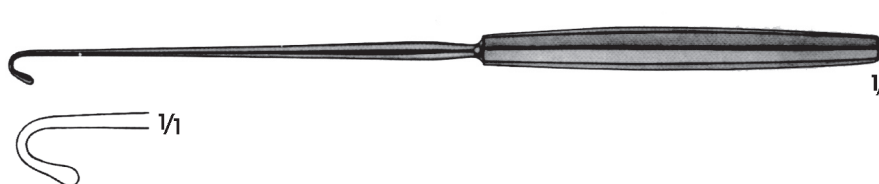

LANGE
K 225.00
23 cm

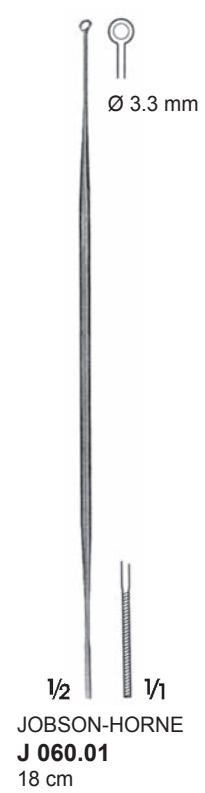
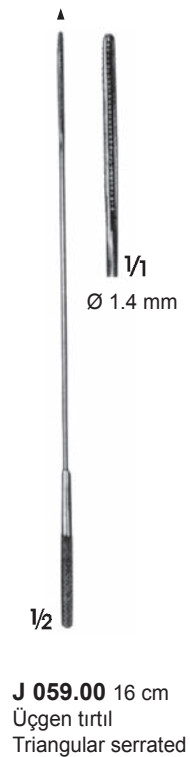
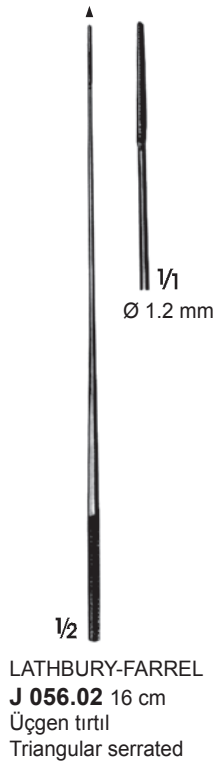

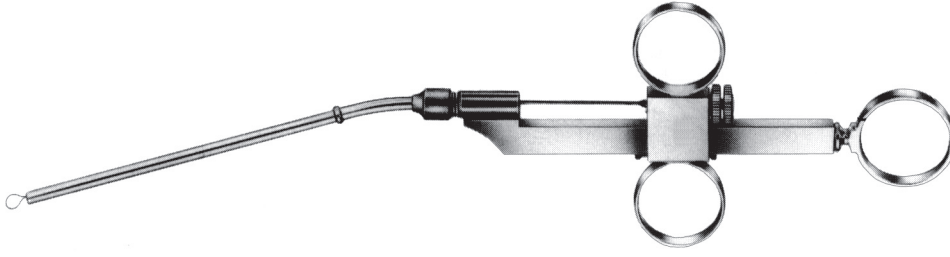

KRAUSE
B 557.00
25 cm

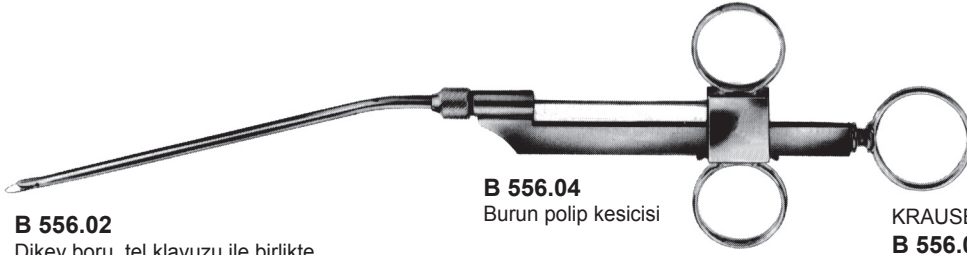

B 556.02
Dikey boru, tel klavuzu ile birlikte
Tube with wire guide only, vertical

B 556.04
Burun polip kesicisi

KRAUSE-VOSS
B 556.00 Komple/Complete
B 556.01-B556.02-B 556.04



B 556.01
Yatay boru, tel klavuzu ile birlikte
Tube with wire guide only, horizontal

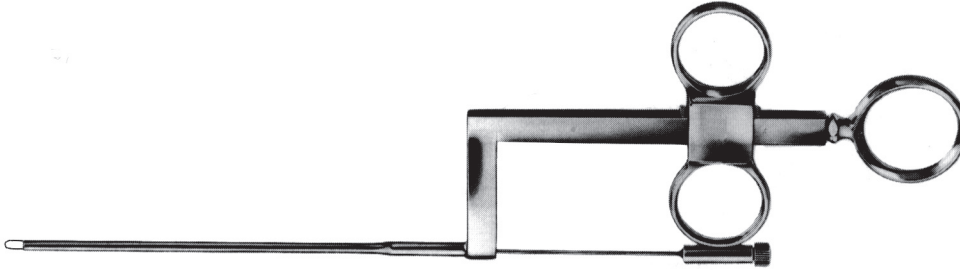

WILDE
B 555.00
25 cm

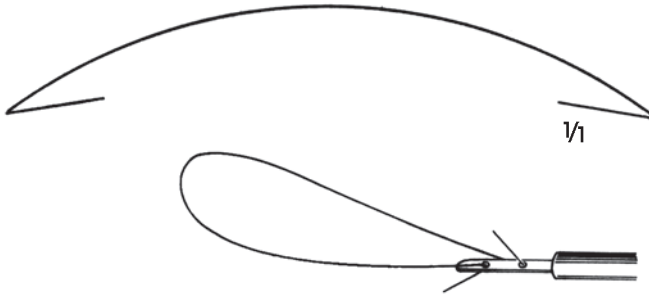

B 583.00 Ø 0.3 mm
12'lik paket
Package of 12 pcs



B 585.00 Ø 0.3 mm
Yumuşak tel/Wire soft
10 m'lik tel bobini
wire coils of 10 m

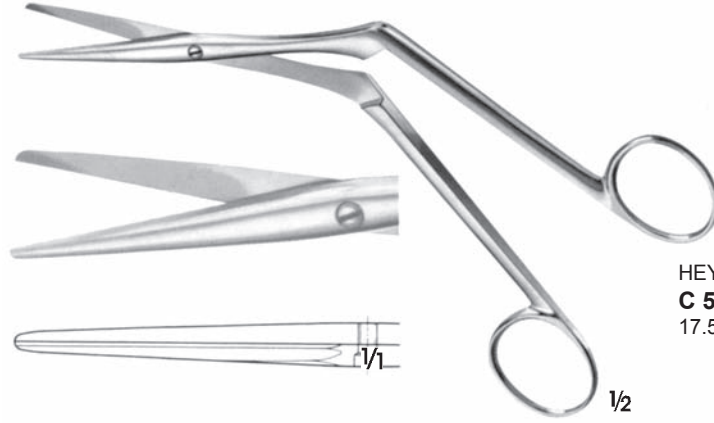

HEYMANN-KNIGHT
C 560.00
17.5 cm

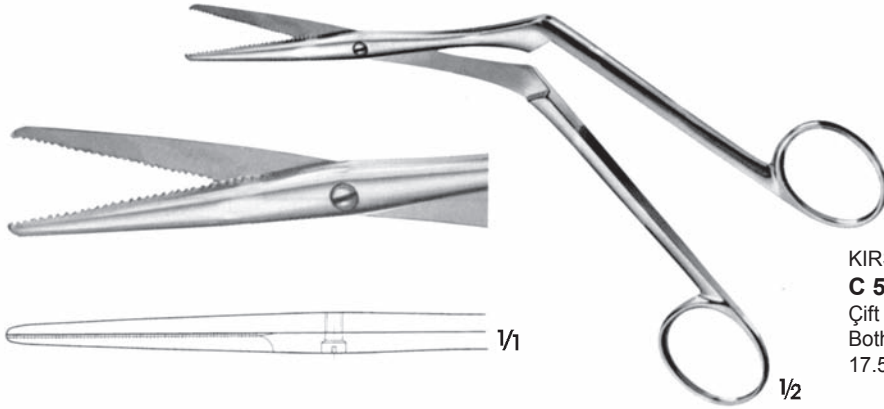

KIRSTEIN
C 561.00
Çift ağız tırtıllı
Both jaws serrated
17.5 cm

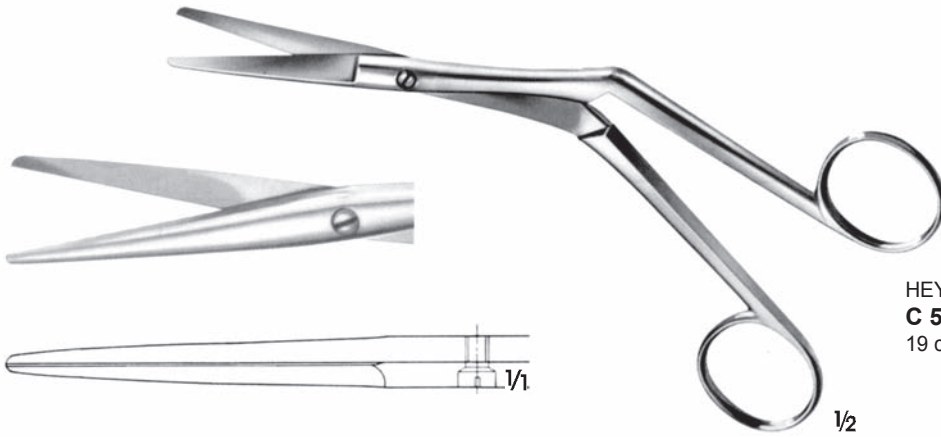

HEYMANN
C 562.00
19 cm



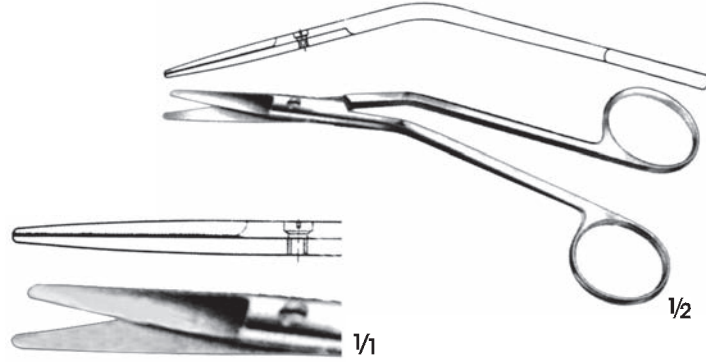

FOMON
C 564.00
Çift ağız tırtıllı
Both jaws serrated
Künt/Blunt
14.5 cm

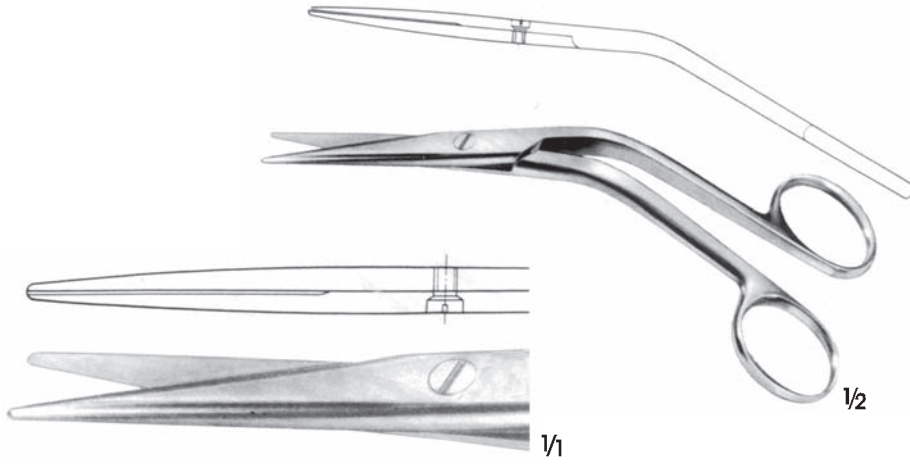

COTTLE
C 566.00
Künt/Blunt
16.5 cm

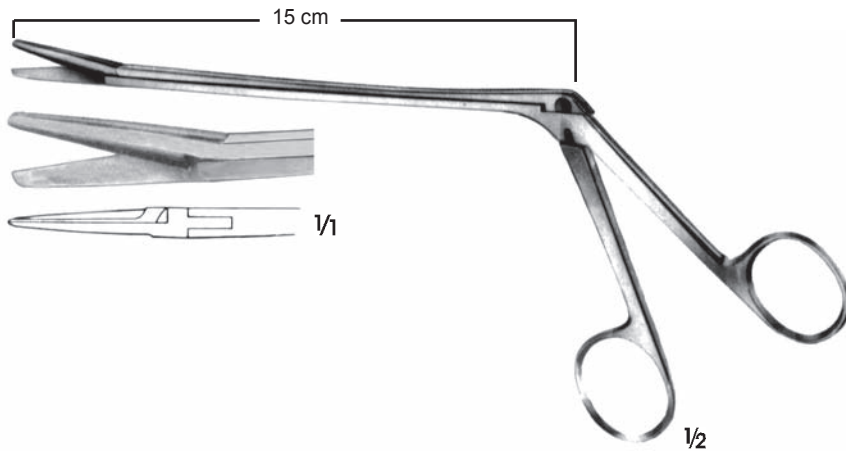

OLIVECRONA
C 530.00
22.5 cm

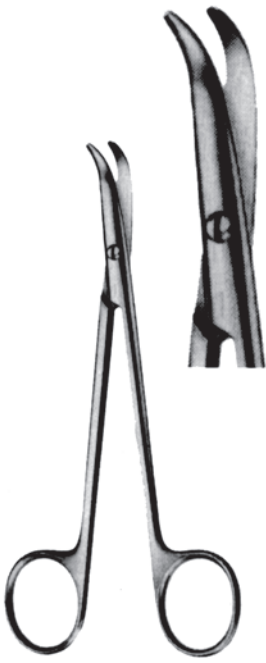

FOMON
C 265.00 - C 266.00
15 cm

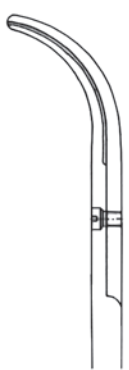

C 265.00
Eğri/Curved
Sivri/Sharp
11.5 cm

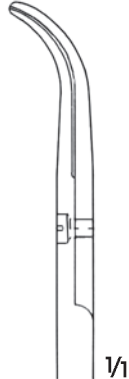

C 266.00
Eğri/Curved
Sivri/Sharp
13.5 cm



JOSEPH
C 250.00 - C 251.00
15 cm

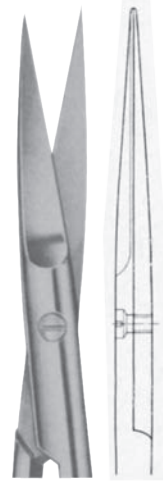

C 250.00
Düz/Straight
Sivri/Sharp

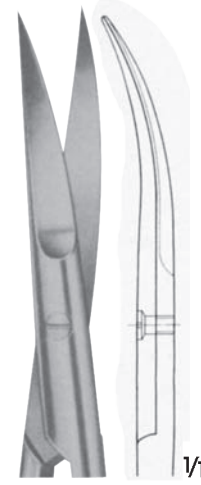

C 251.00
Eğri/Curved
Sivri/Sharp



C 430.00
Düz/Straight
12.5 cm

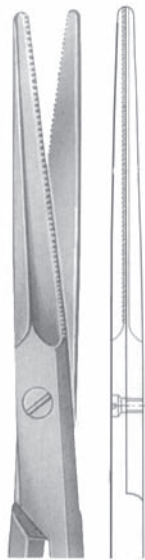
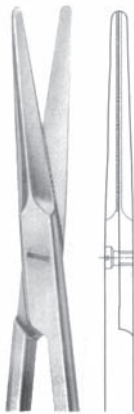

C 430.01
Düz/Straight
19.5 cm



C 431.00
Eğri/Curved
19.5 cm



C 435.00
Sivri/Sharp

C 435.00
Çift ağız tırtıllı
Both jaws serrated
18.5 cm

GORNEY
C 430.00 - C 431.00
Bleydler : Dış taraflar yarı keski
İç taraflar ince tırtıllı
Blades : Outside semi-sharp
Inside fine serrated

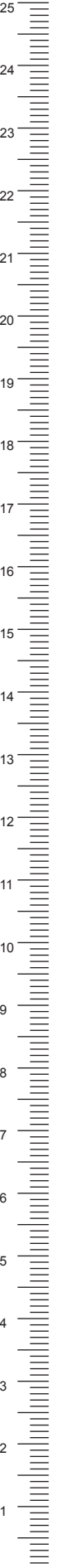



$\frac{1}{2}$
FREER
B 260.00
15.5 cm



$\frac{1}{2}$
BRÜNINGS
B 252.00
16 cm

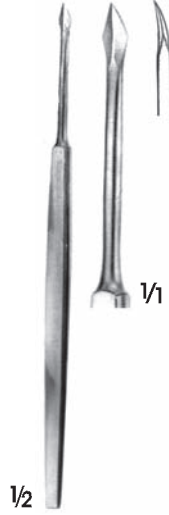

$\frac{1}{2}$
MASING
B 130.00
13 cm



$\frac{1}{2}$
JOSEPH
B 134.00 - B 135.00
14.5 cm

B 134.00
Düz/Straight

B 135.00
Eğri/Curved

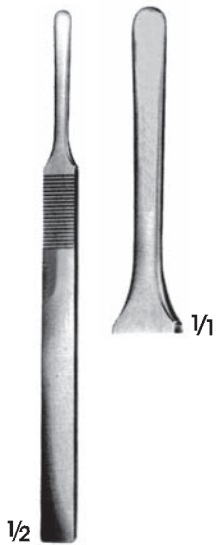

$\frac{1}{2}$
COTTLE
B 231.00
14 cm

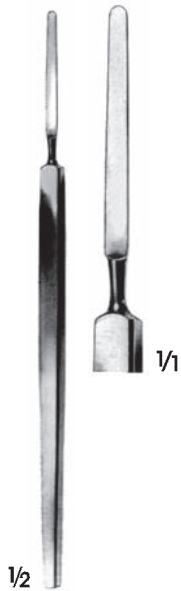

$\frac{1}{2}$
COTTLE
B 232.00
15 cm

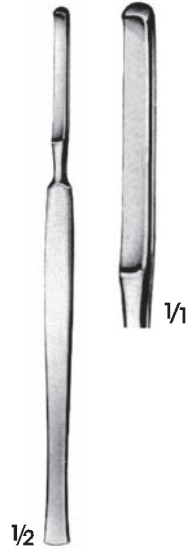

$\frac{1}{2}$
JOSEPH
B 233.00
14 cm



$\frac{1}{2}$
CONVERSE
B 234.00
15 cm



$\frac{1}{2}$
JOSEPH
B 230.00
17.5 cm

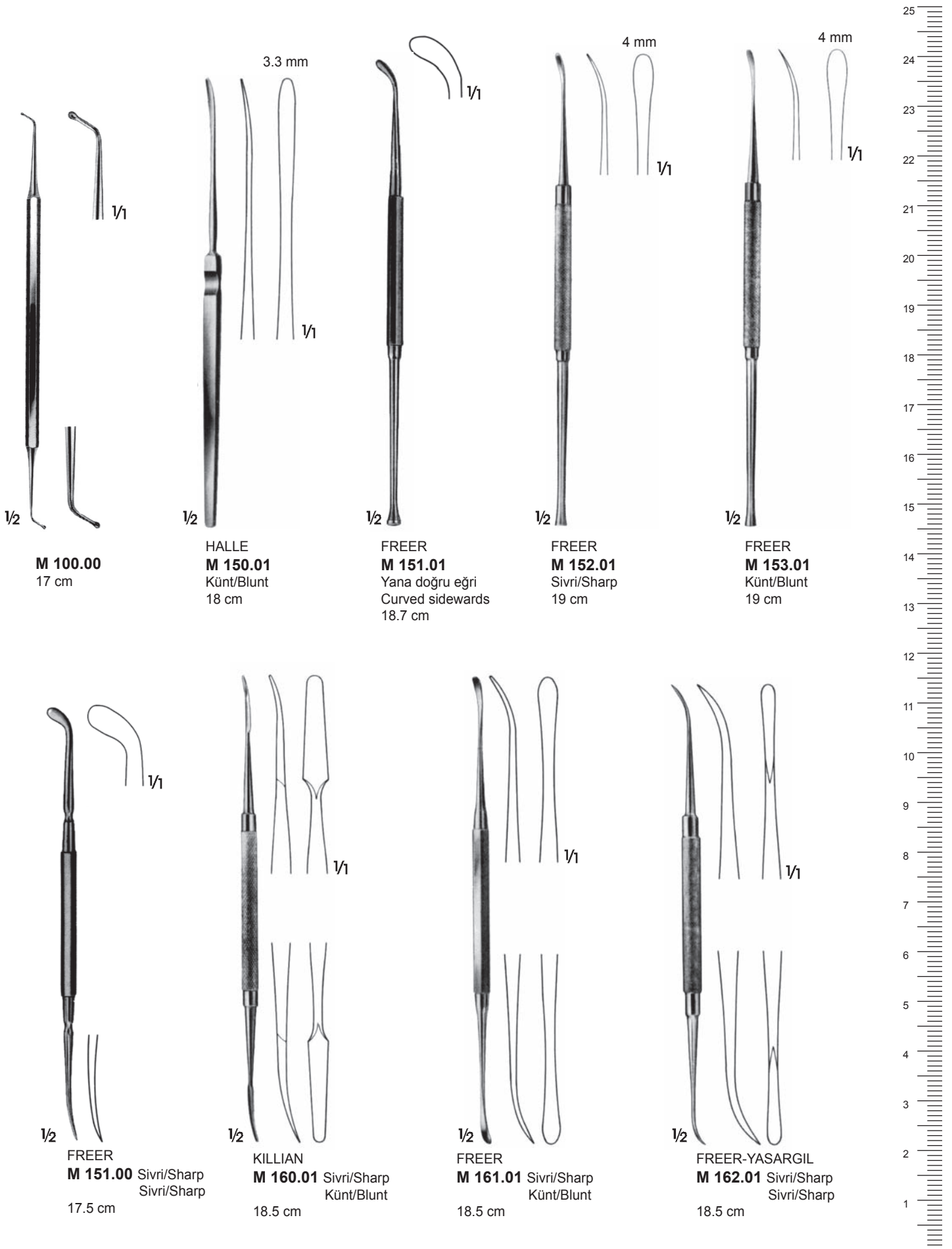

M 100.00
17 cm

HALLE
M 150.01
Künt/Blunt
18 cm

FREER
M 151.01
Yana doğru eğri
Curved sideways
18.7 cm

FREER
M 152.01
Sivri/Sharp
19 cm

FREER
M 153.01
Künt/Blunt
19 cm

FREER
M 151.00 Sivri/Sharp
Sivri/Sharp
17.5 cm

KILLIAN
M 160.01 Sivri/Sharp
Künt/Blunt
18.5 cm

FREER
M 161.01 Sivri/Sharp
Künt/Blunt
18.5 cm

FREER-YASARGIL
M 162.01 Sivri/Sharp
Sivri/Sharp
18.5 cm

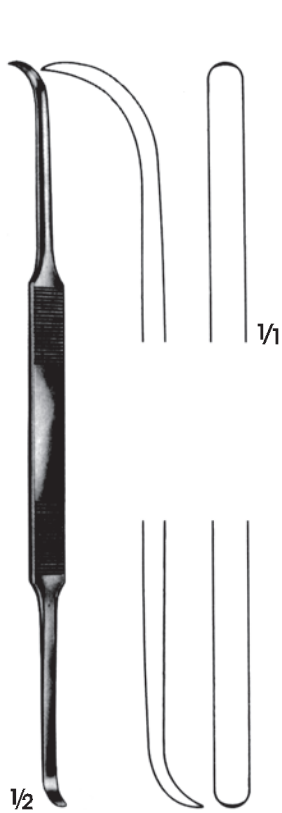

COTTLE
M 193.01 Sivri/Sharp
Sivri/Sharp
20 cm

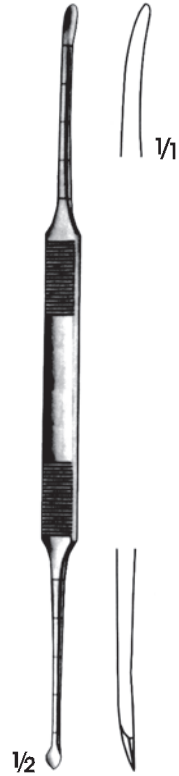

MASING
M 195.01 Künt/Blunt
Sivri/Sharp
20 cm



COTTLE
M 196.01 Sivri/Sharp
Sivri/Sharp
20 cm

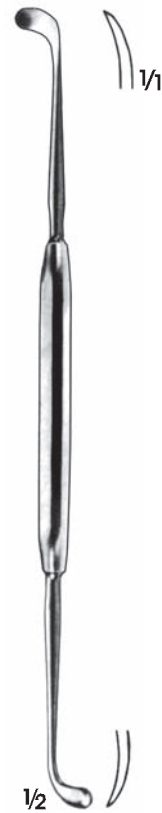

PENNINGTON
M 197.01 Sivri/Sharp
Sivri/Sharp
21 cm



PIERCE
M 198.01 Sivri/Sharp
Sivri/Sharp
21 cm



VIDAL
M 163.00 Sivri/Sharp
13.5 cm

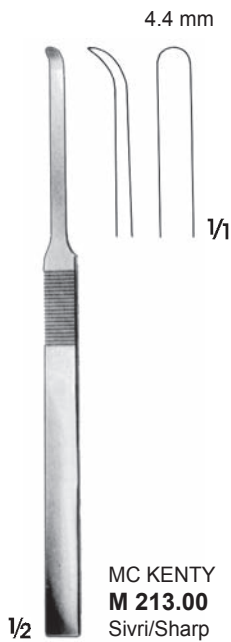

MC KENTY
M 213.00 Sivri/Sharp
15.5 cm



M 236.01 - M 236.02
Sivri/Sharp
17 cm

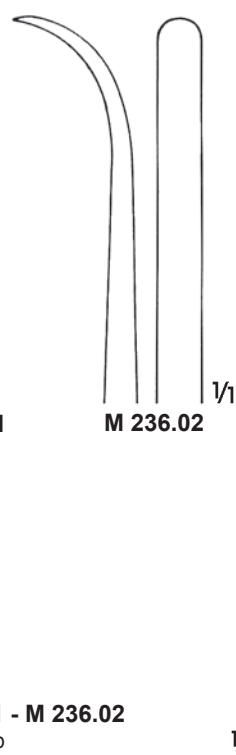

M 236.02



SEWALL
M 170.01 Künt/Blunt
20 cm

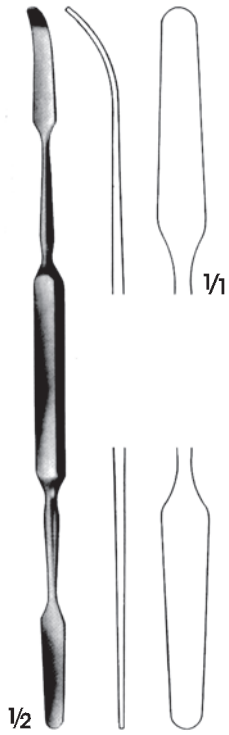

MAC DONALD
M 190.01 Künt/Blunt
Künt/Blunt
18.5 cm

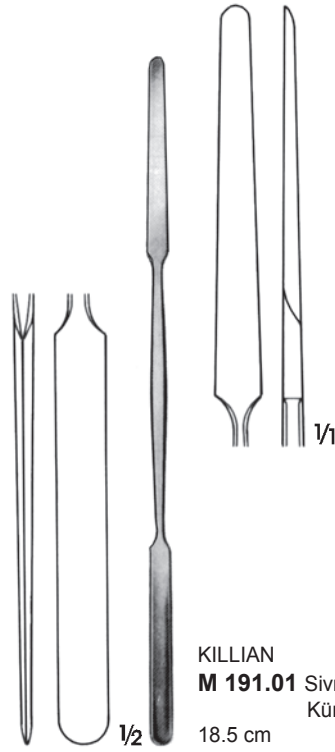

KILLIAN
M 191.01 Sivri/Sharp
Künt/Blunt
18.5 cm

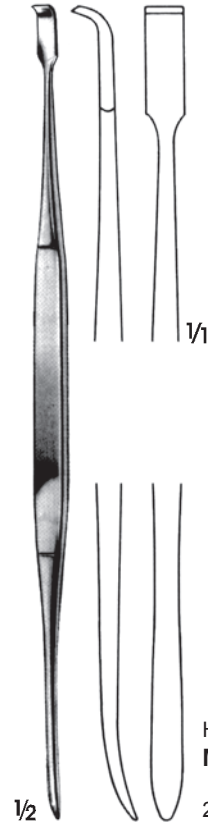

HOWARTH
M 194.01 Sivri/Sharp
Künt/Blunt
21.5 cm

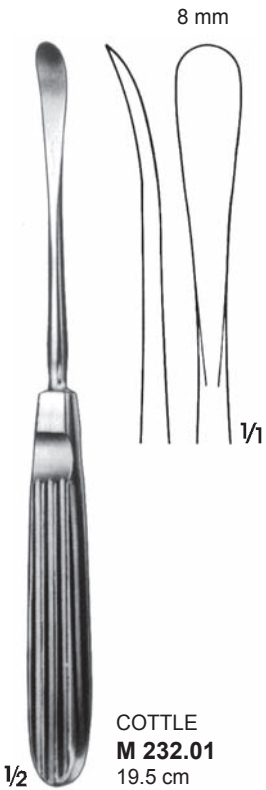

COTTLE
M 232.01
19.5 cm

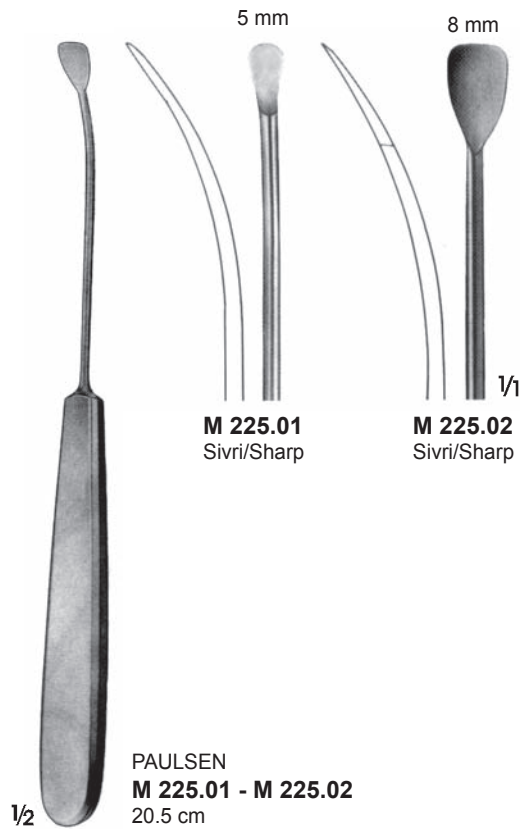

M 225.01
Sivri/Sharp

M 225.02
Sivri/Sharp

PAULSEN
M 225.01 - M 225.02
20.5 cm

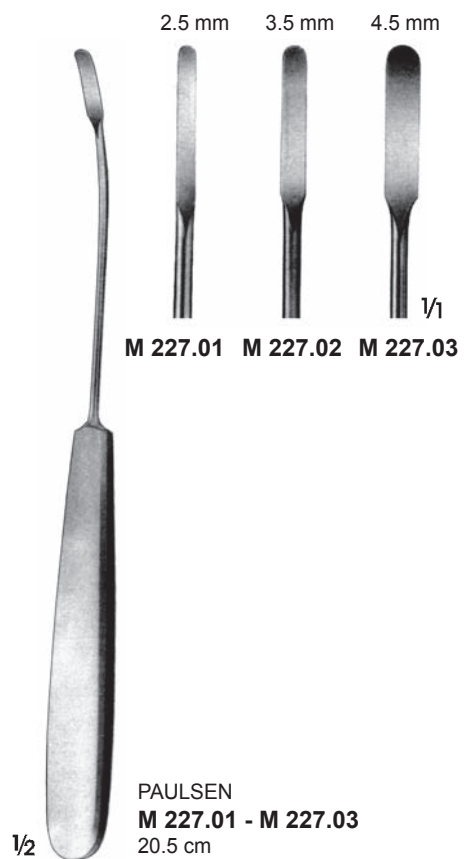

M 227.01

M 227.02

M 227.03

PAULSEN
M 227.01 - M 227.03
20.5 cm



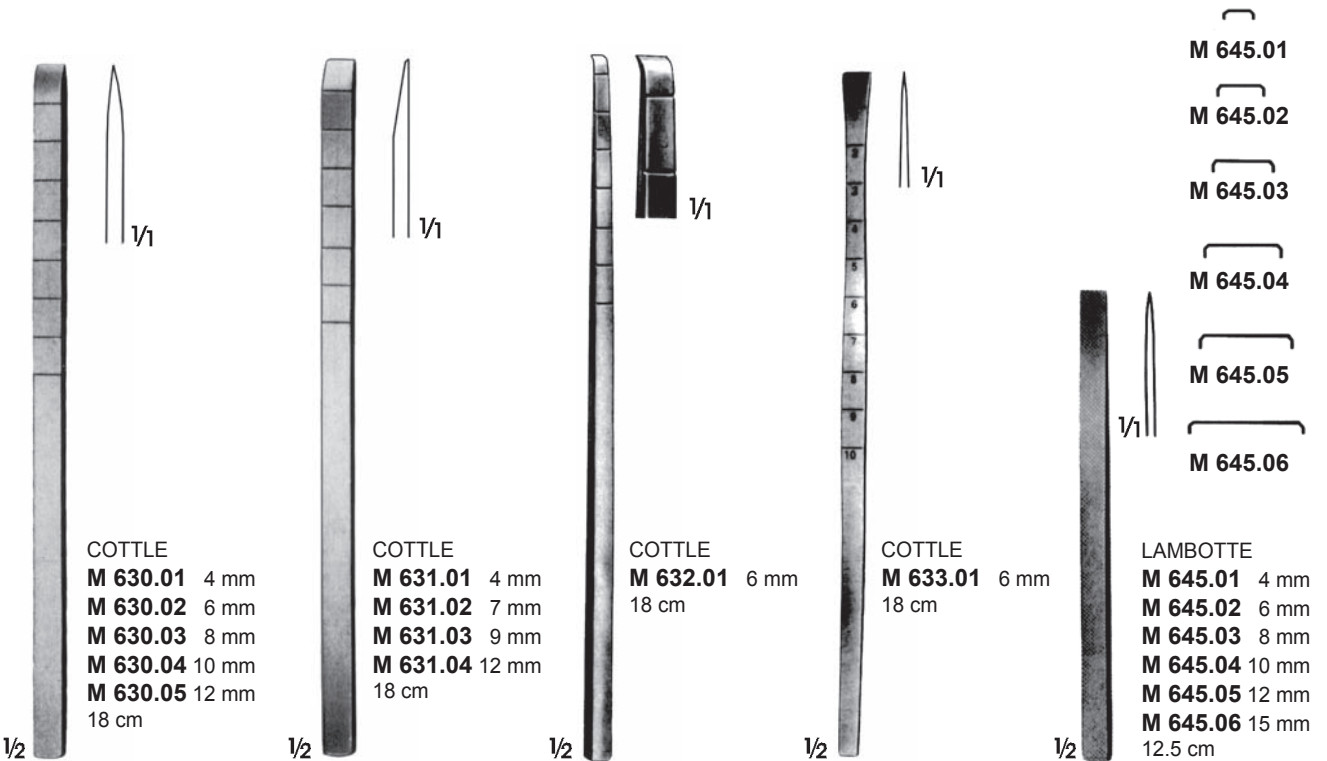
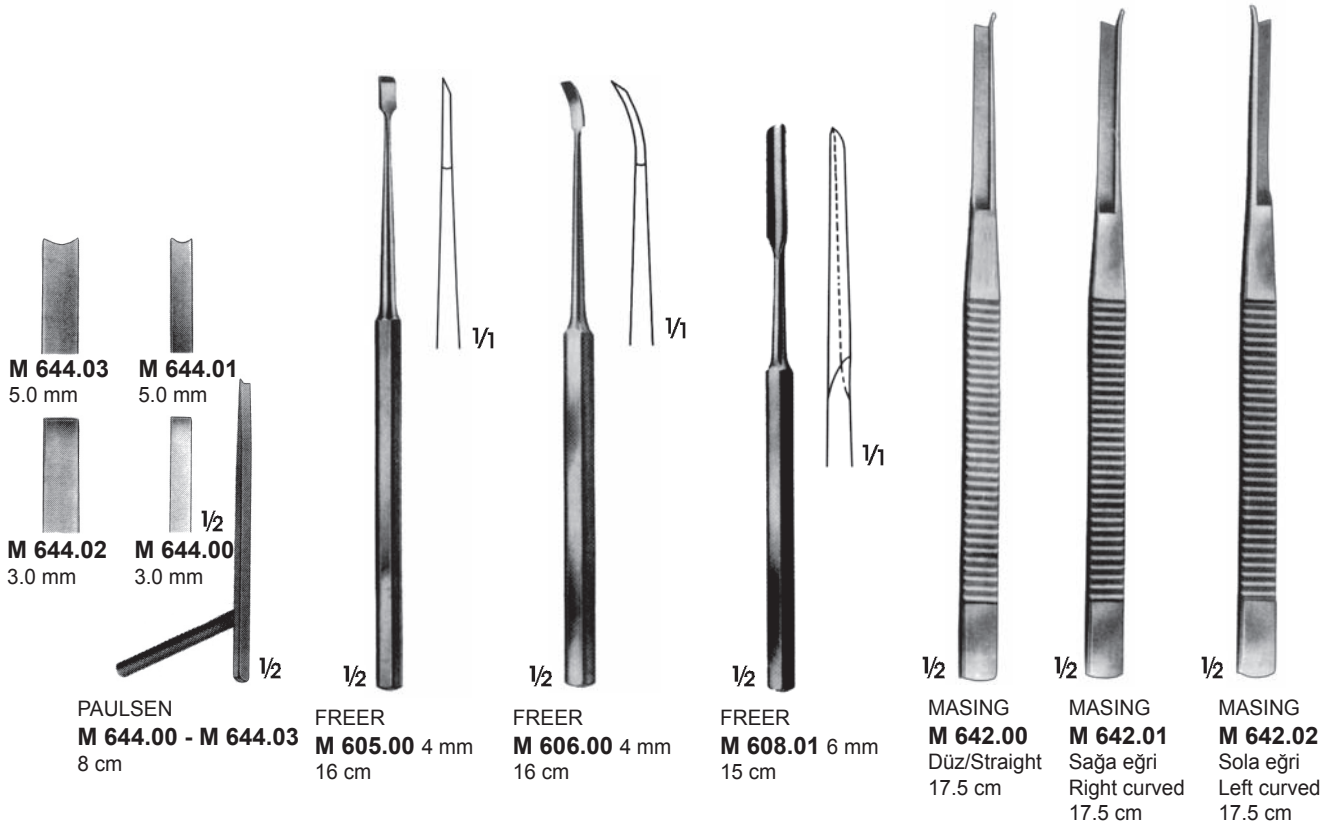

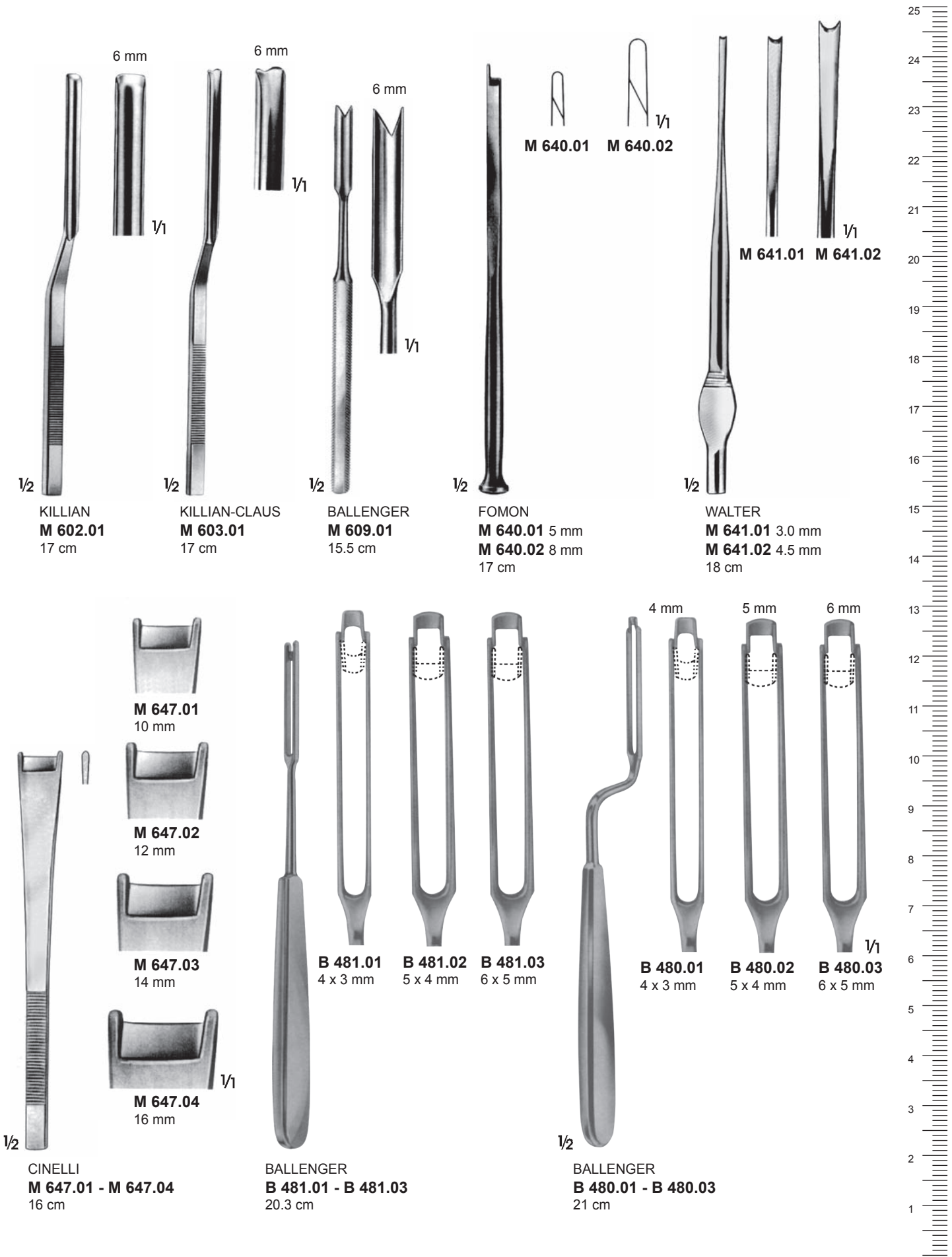

KILLIAN
M 602.01
17 cm

KILLIAN-CLAUS
M 603.01
17 cm



BALLENGER
M 609.01
15.5 cm



FOMON
M 640.01 5 mm
M 640.02 8 mm
17 cm

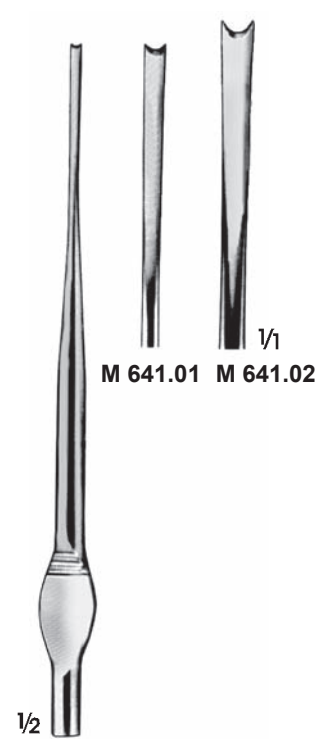

WALTER
M 641.01 3.0 mm
M 641.02 4.5 mm
18 cm

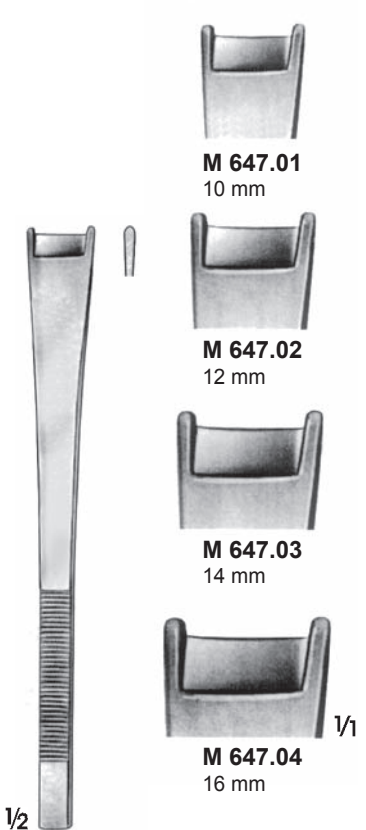

CINELLI
M 647.01 - M 647.04
16 cm

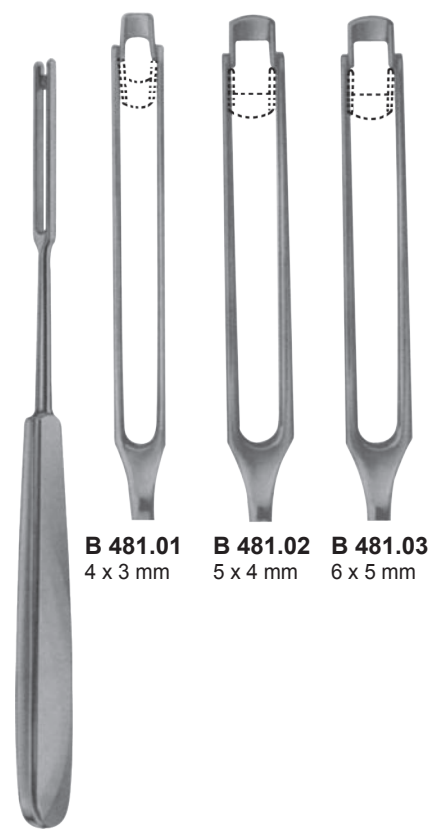

BALLENGER
B 481.01 - B 481.03
20.3 cm

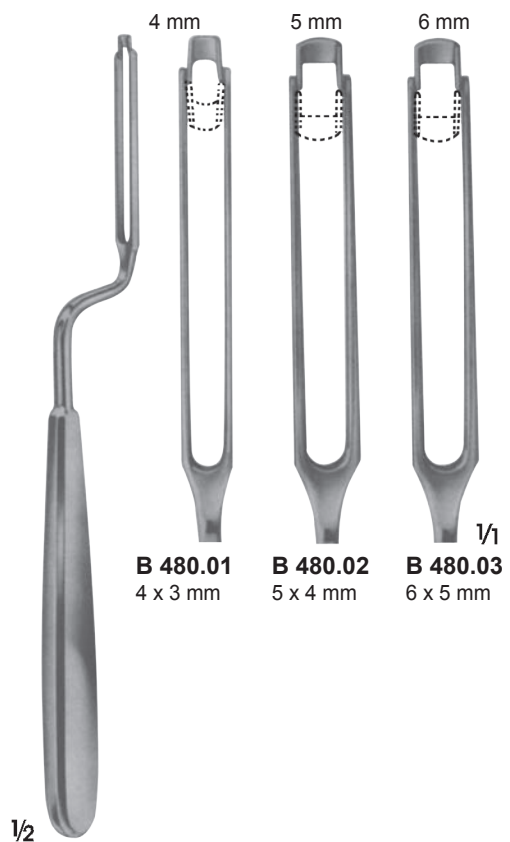

BALLENGER
B 480.01 - B 480.03
21 cm

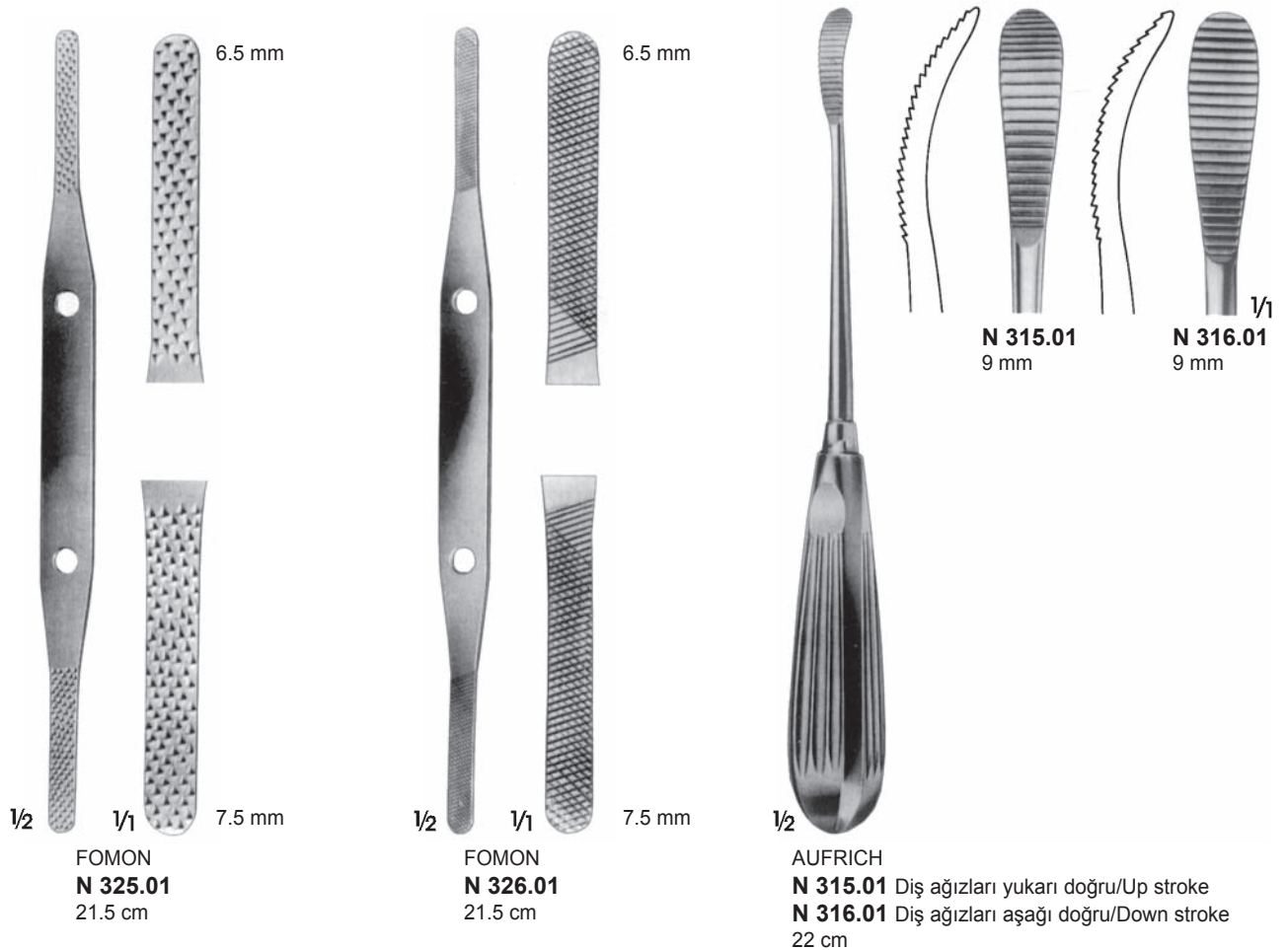
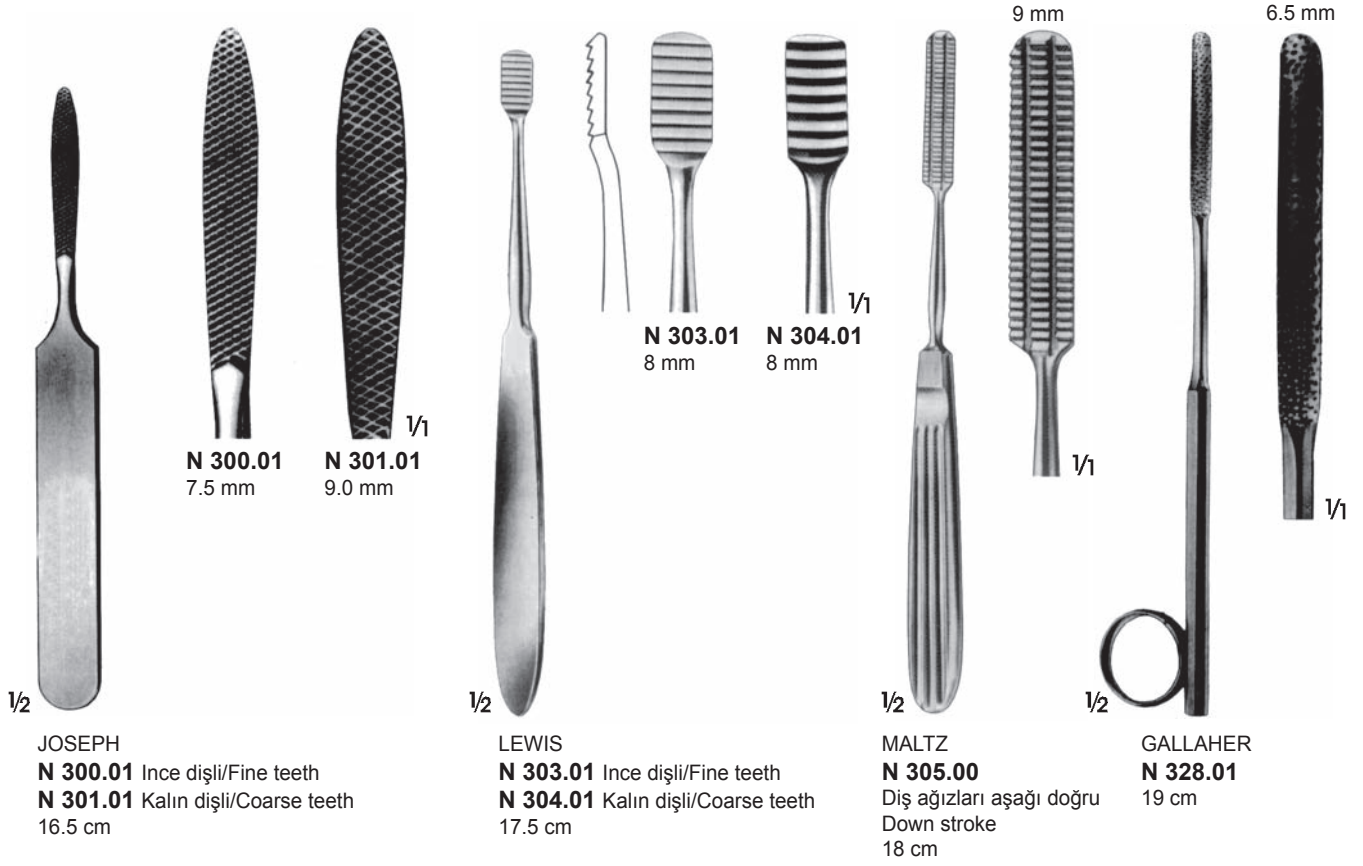



1/2

MILLER
N 320.01 - N 322.01
18 cm



N 320.01

1/1 5 mm



N 321.01

1/1 4.3 mm

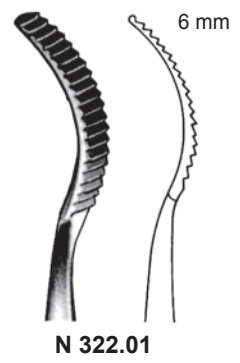

N 322.01

1/1 5 mm

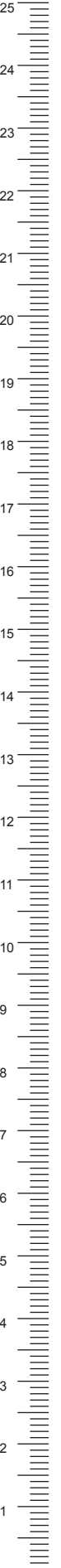

1/2

N 330.01 - N 330.05
20.5 cm

Diş
Teeth

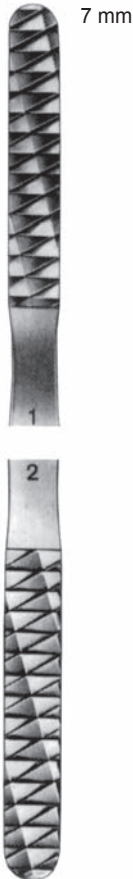

N 330.01
12/14



N 330.02
16/20



N 330.03
24/30



N 330.04
36/44

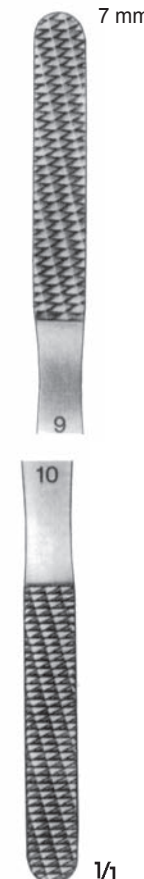

N 330.05
52/62

1/1

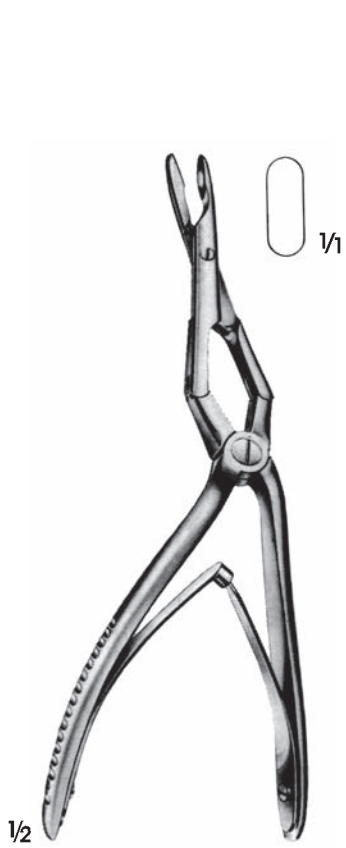

JANSEN-MIDDLETON
P 580.00
 20 cm

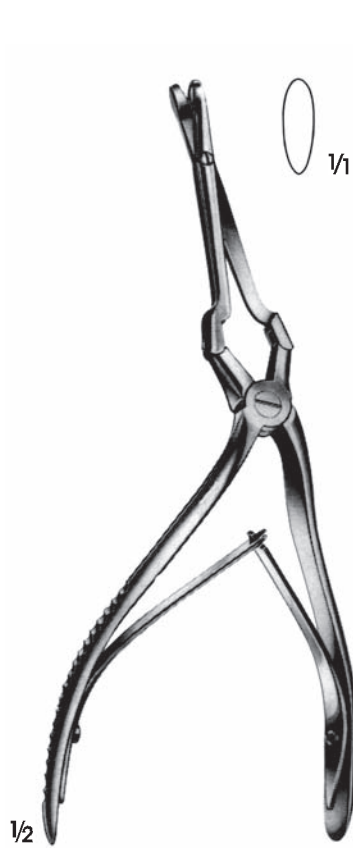

JANSEN-MIDDLETON
P 581.00
 21 cm



KRESSNER
P 585.01 - P 585.02
 22 cm



BOIES
M 455.01
 18 cm



GOLDMANN
M 457.01
 20 cm



COTTLE-WALSHAM
P 200.00
 22 cm



P 210.00
20 cm



P 201.00
Sol/Left

P 201.01
Sağ/Right

WALSHAM
P 201.00 - P 201.01
21 cm



ASH
P 203.00
22 cm



DINGMANN
P 125.00
18.5 cm



LANGENBECK
P 151.00
20.5 cm

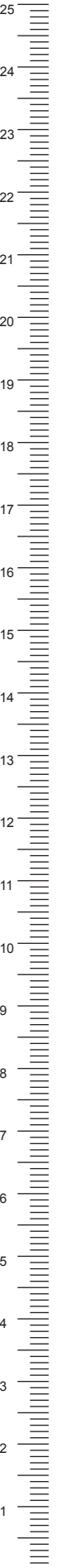



HEYMANN
R 320.00
18 cm

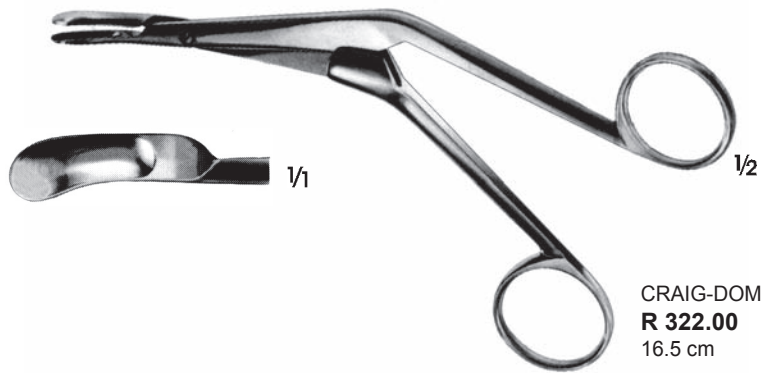

CRAIG-DOMNICK
R 322.00
16.5 cm



CRAIG
R 324.00 - R 325.00
16.5 cm



HEMANN-KNIGHT
R 327.00
19 cm

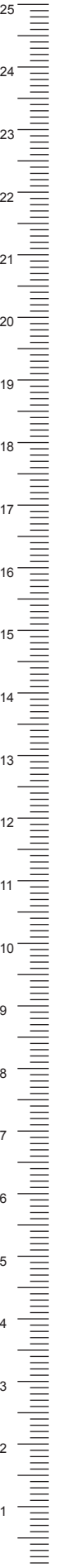
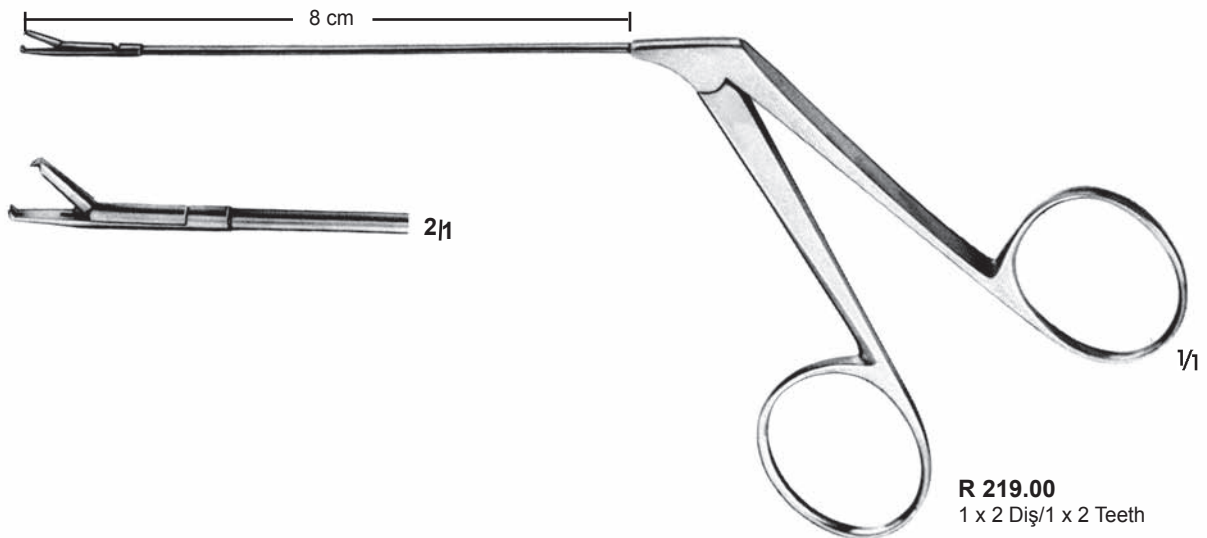
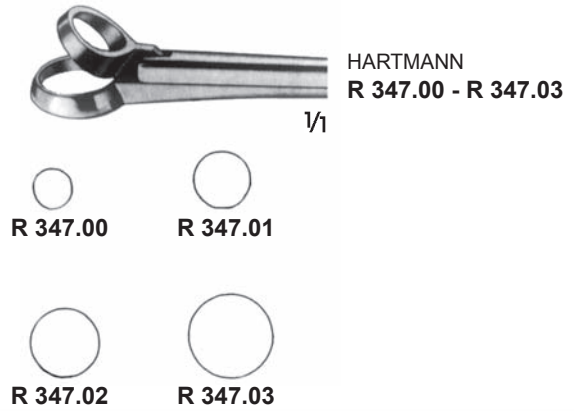
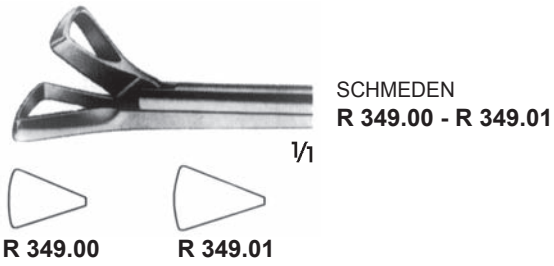
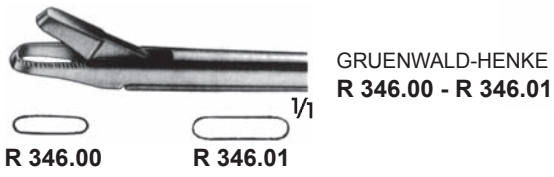
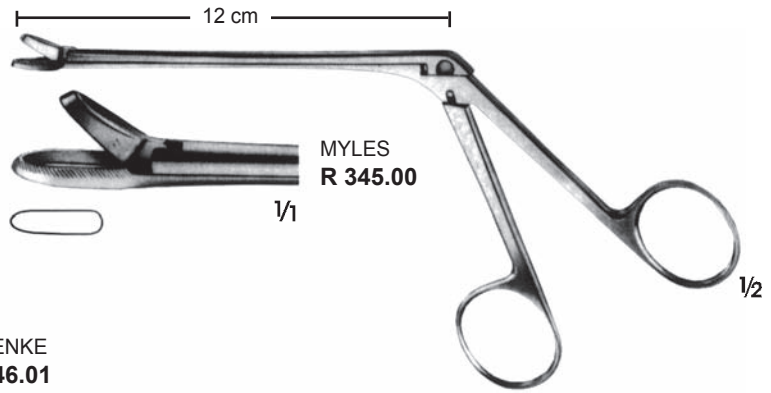
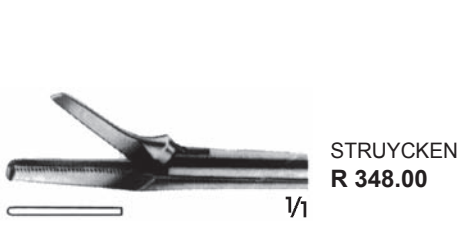
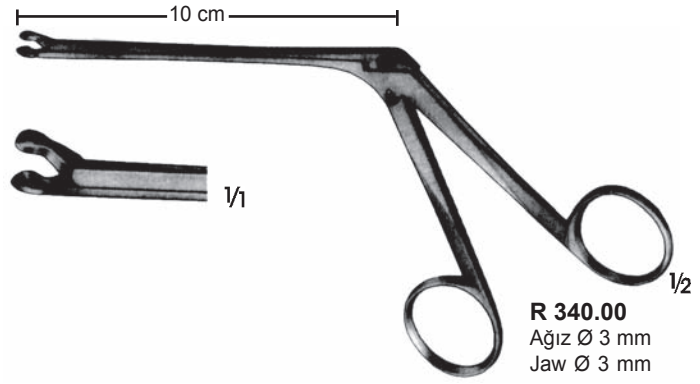

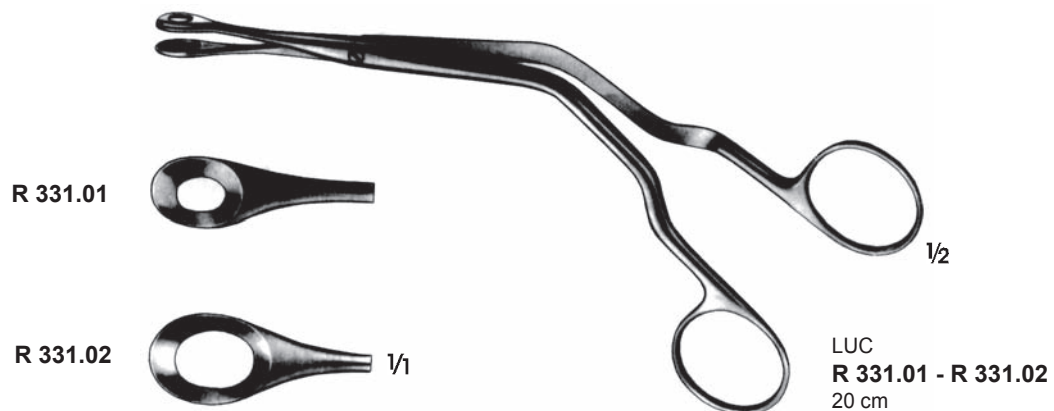
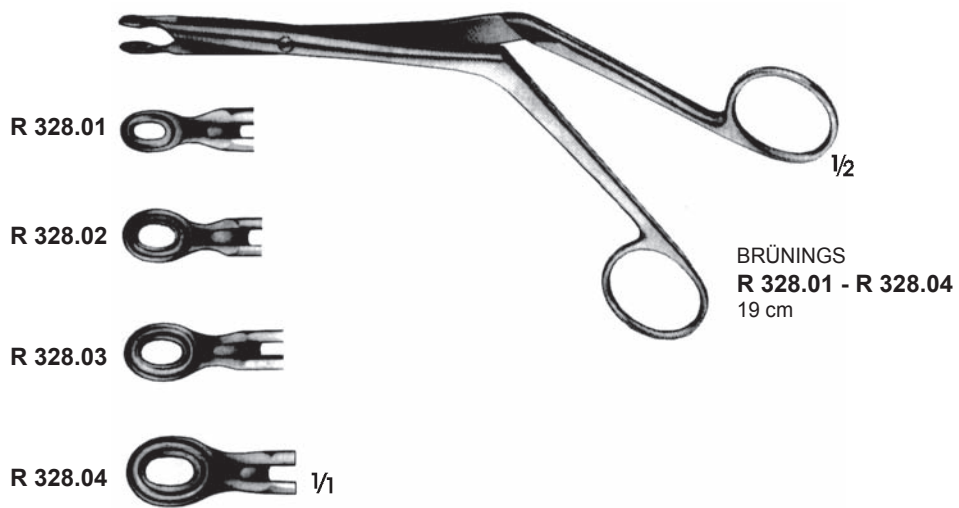

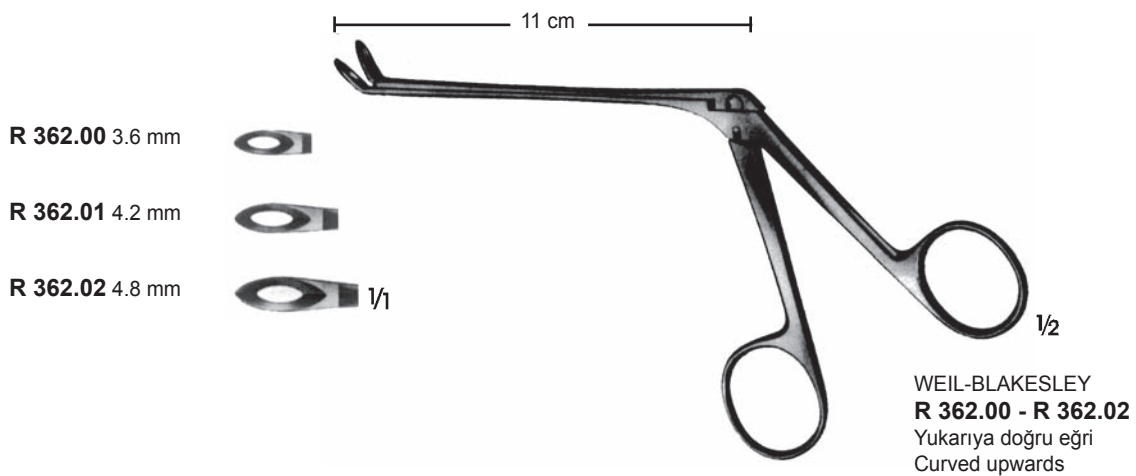
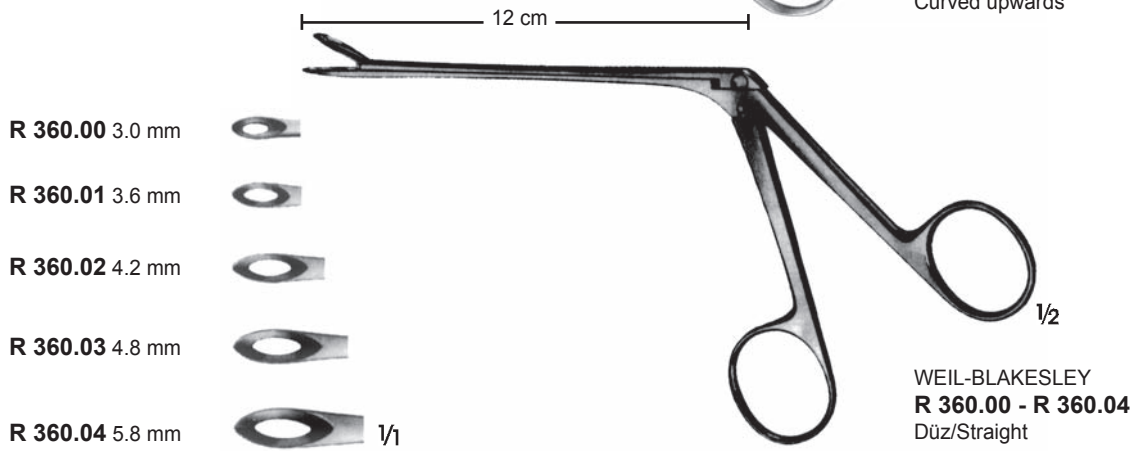
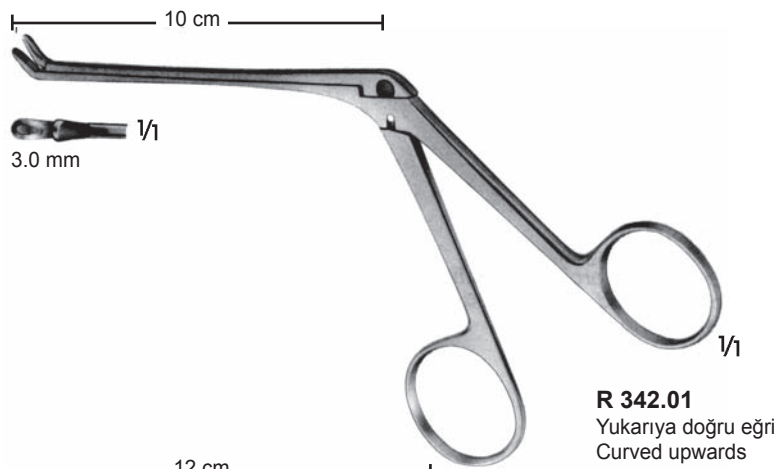
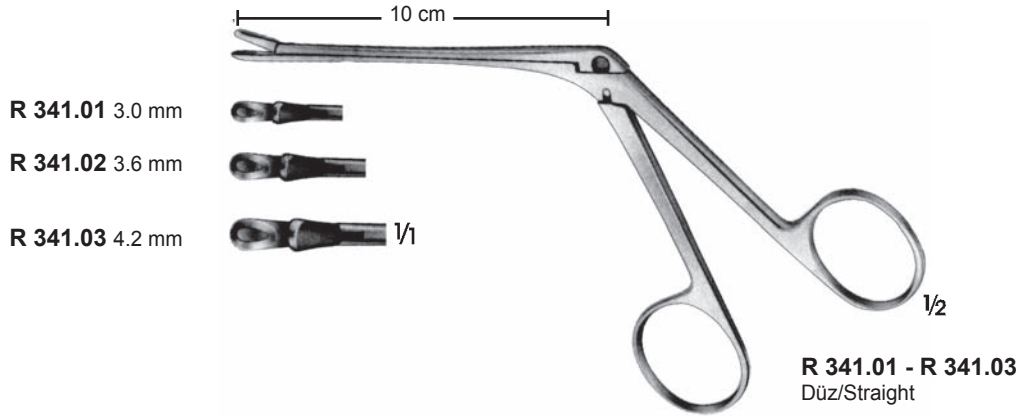

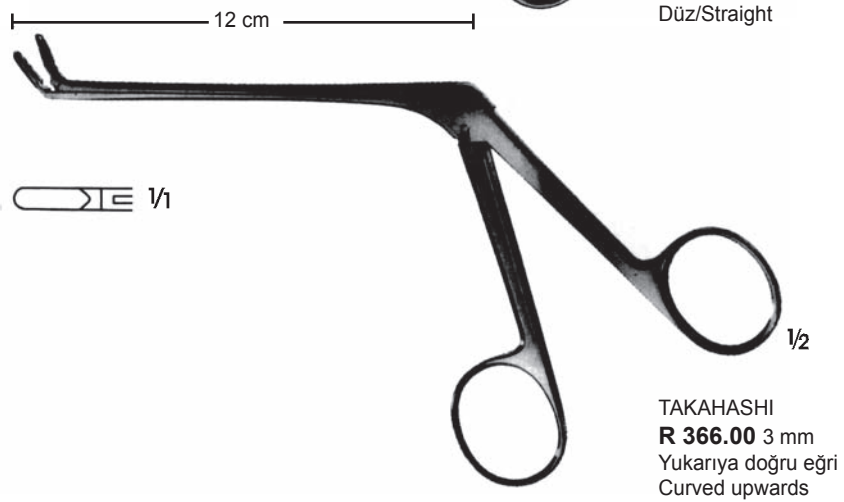
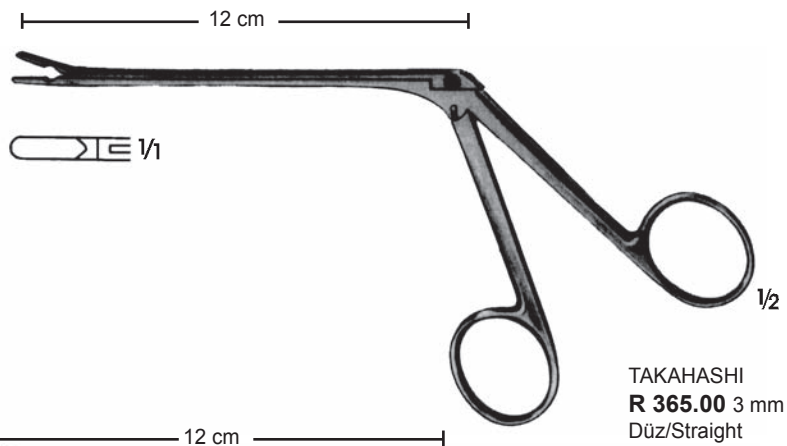
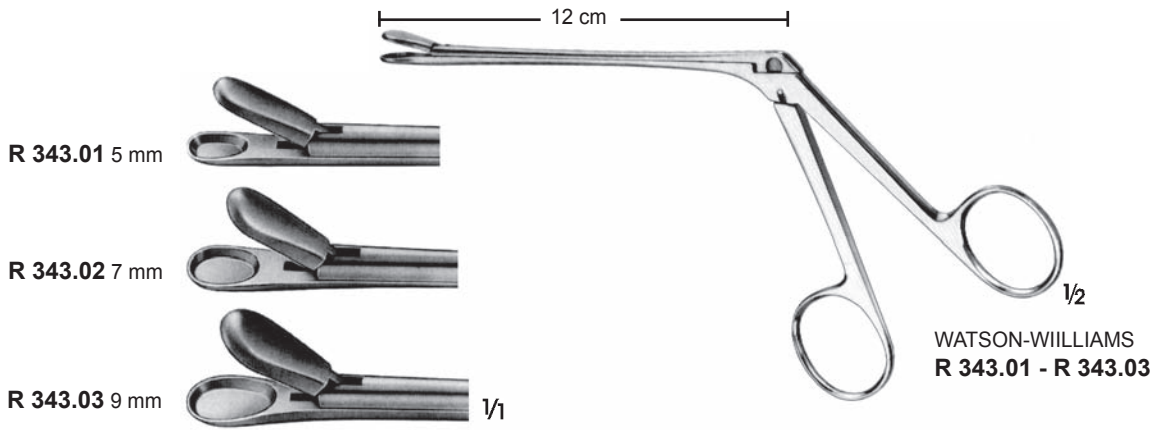

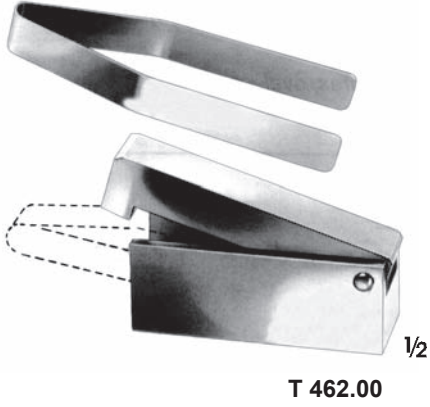

T 462.00



JOSEPH
V 765.00
Düz/Straight
17 cm



JOSEPH
V 765.01
Sola doğru eğri,
Curved to left
17 cm



JOSEPH
V 765.02
Sağa doğru eğri,
Curved to right
17 cm



LINDEMANN
V 766.00
Düz/Straight
20 cm



LANGENBECK
T 600.00
Düz/Straight
23.5 cm

11.5 cm
Bleyd uzunluğu
Length of blade





Sinüs ve Hipofizektomi
Sinus and Hypophysectomy

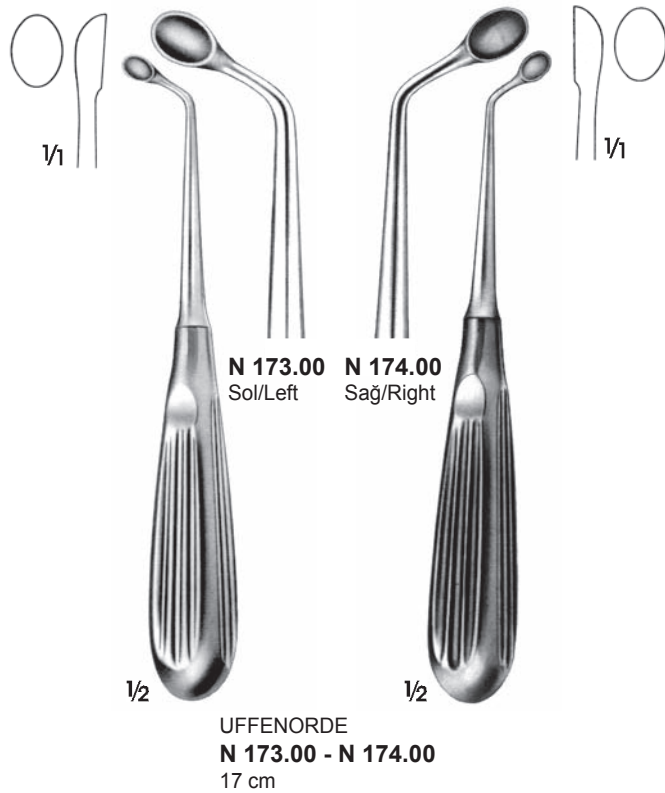
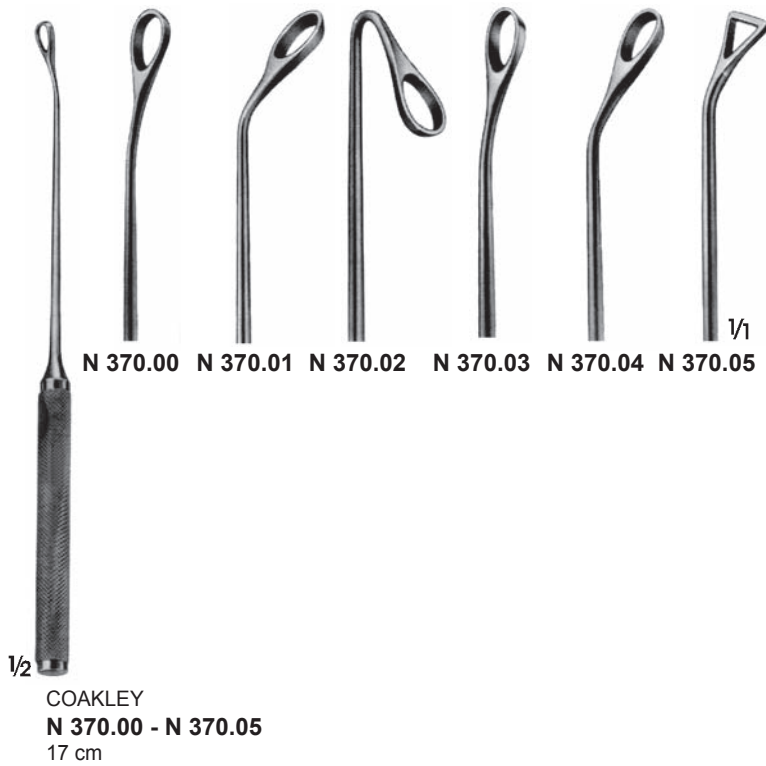



B 128.00

B 128.01

B 128.00 Sivri uçlu/Pointed
B 128.01 Yuvarlak/Round
19 cm

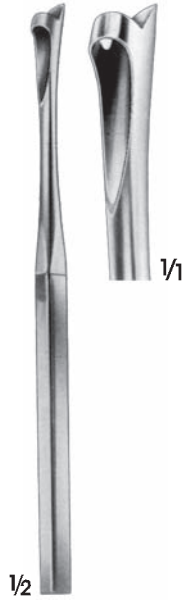

1/1

1/2

FAULKNER
M 659.01
15 cm



1/1

1/2

N 308.00 Sivri/Sharp
N 308.01 Küt/Blunt
18 cm

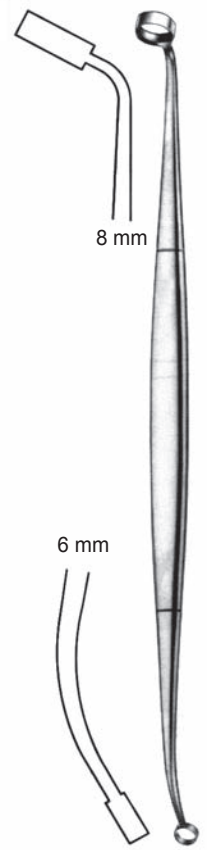

8 mm

6 mm

FAULKNER
N 372.01
22 cm



1/2

STERNBERG
K 346.00 12 cm
K 346.01 13 cm
K 346.02 13.5 cm

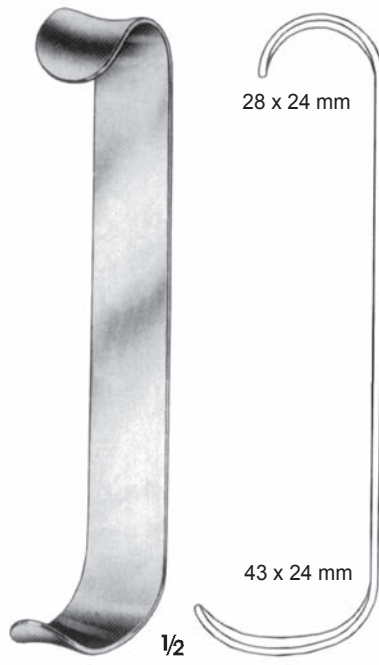

28 x 24 mm

43 x 24 mm

1/2

ROUX
K 327.00
17 cm



1/2

BRÜNINGS-BRUNK
K 590.00
19 cm



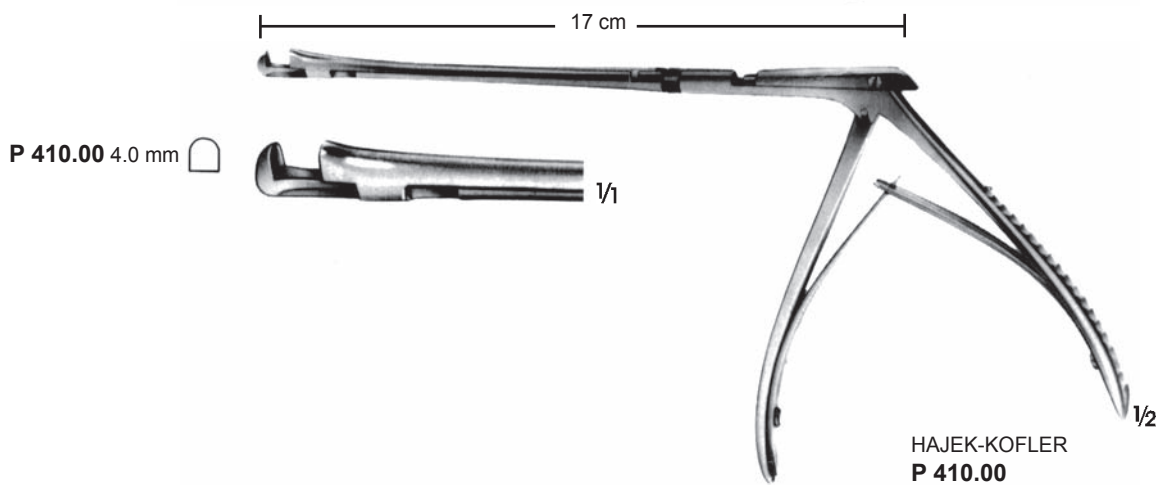
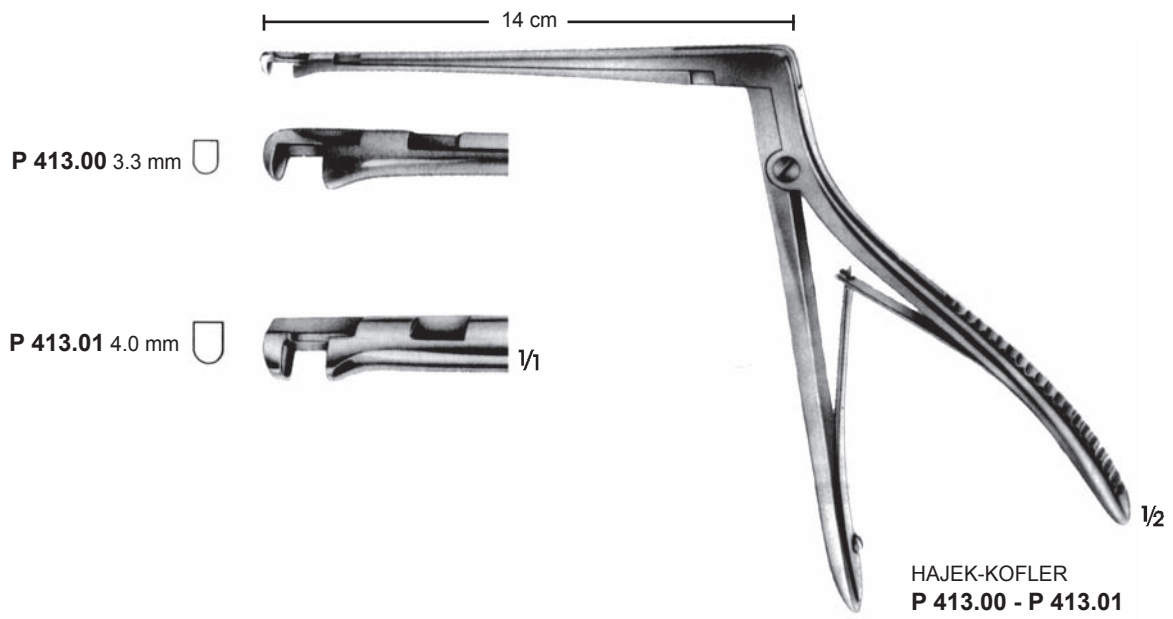
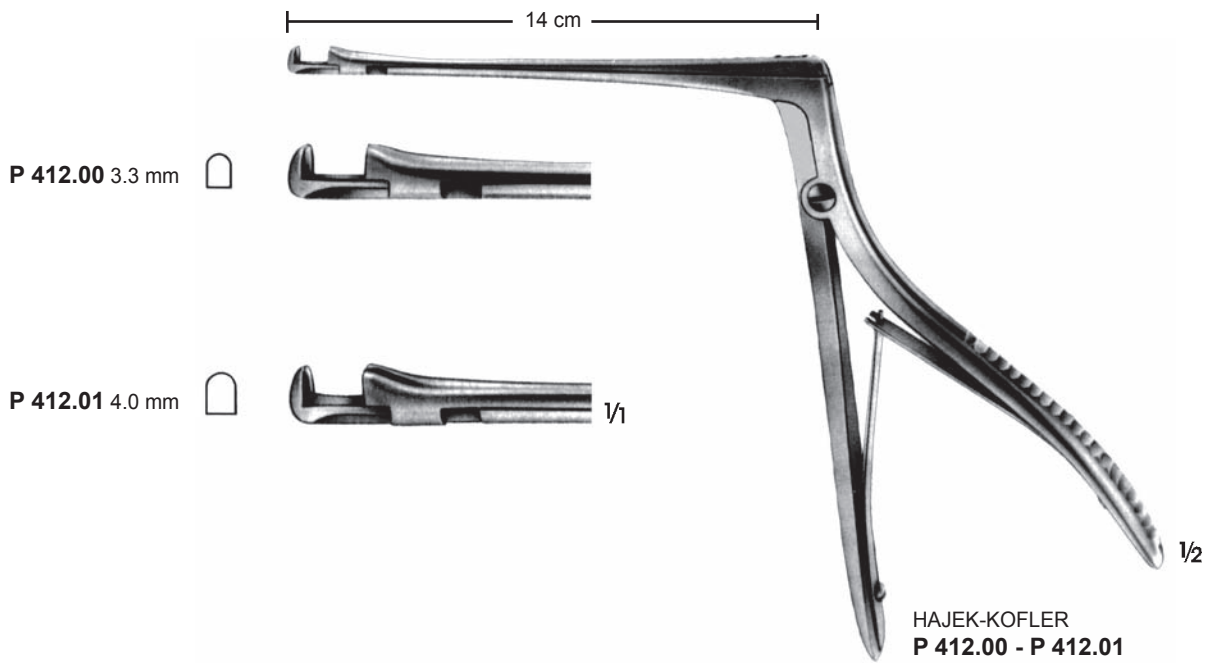

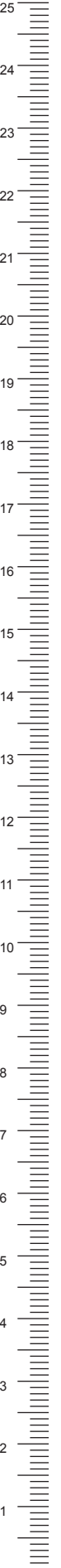
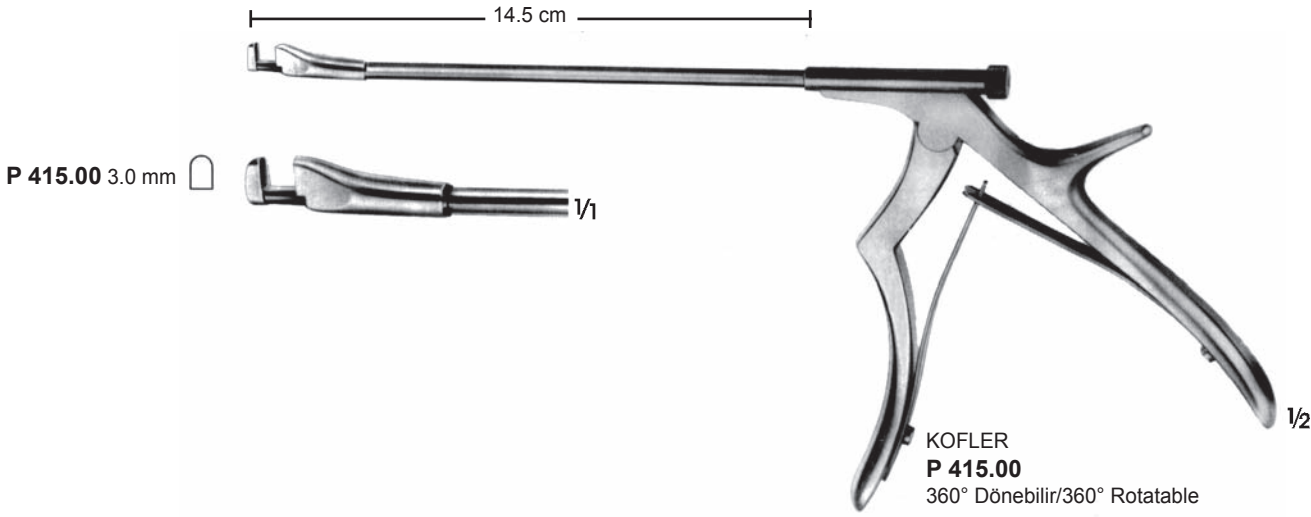

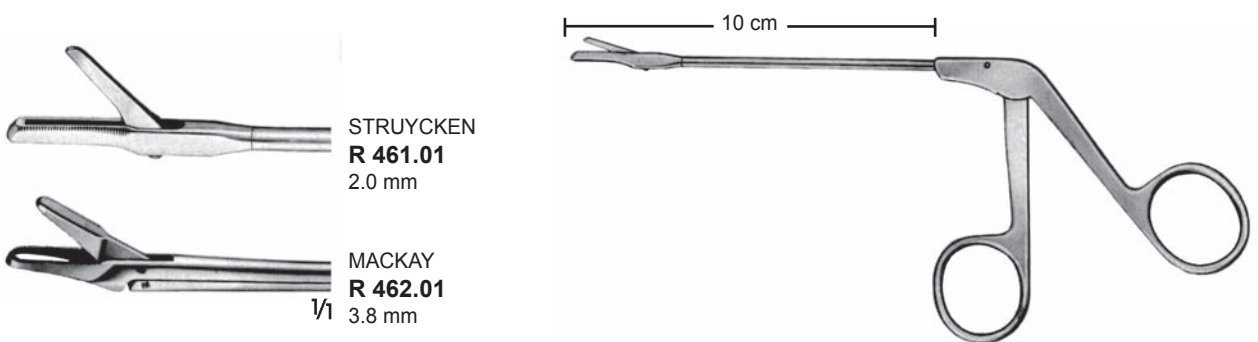
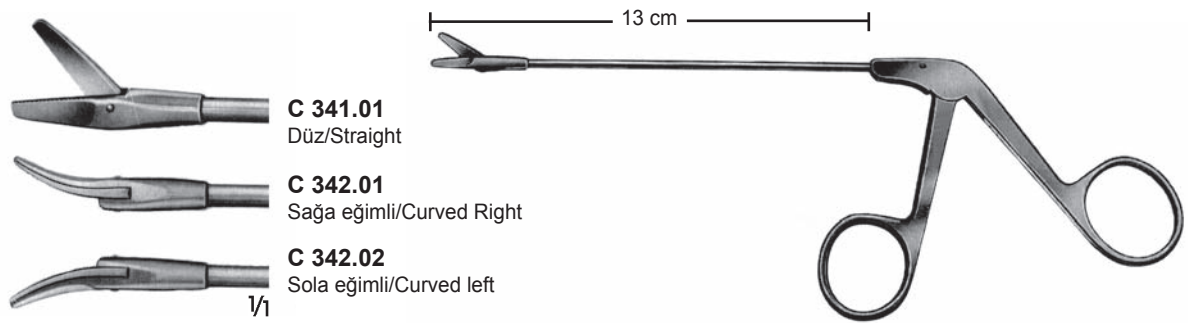
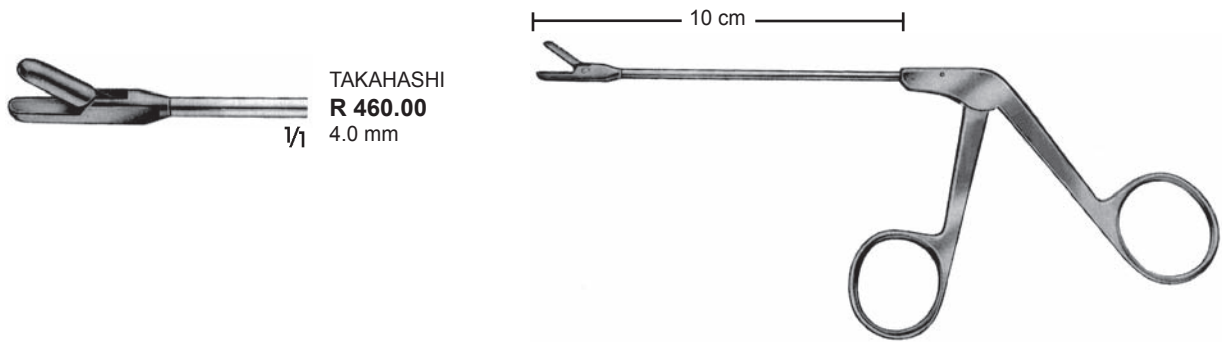
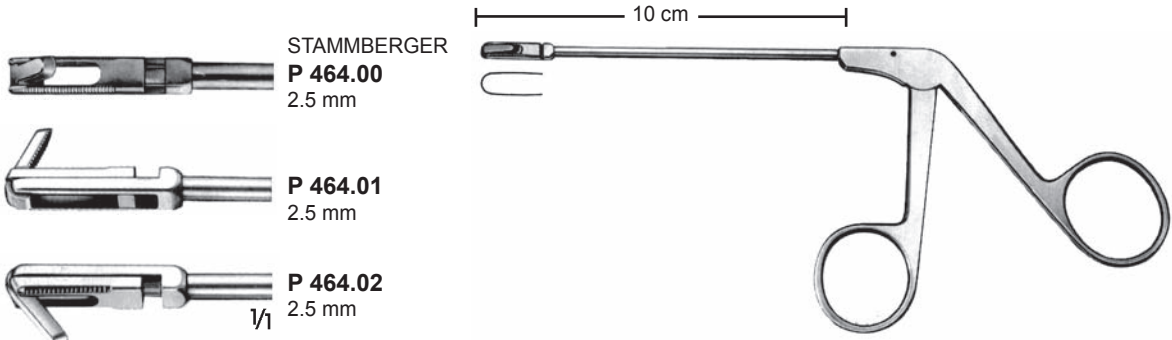



KENNEDY-BLAKESLEY
R 463.01 - R 463.03



R 463.01
3.6 mm



R 463.02
4.2 mm



R 463.03
5.0 mm



R 464.01
3.6 mm

R 464.02
4.2 mm

KENNEDY-BLAKESLEY
R 464.01 - R 464.02



R 465.01
3.6 mm

R 465.02
5.0 mm

BLAKESLEY
R 465.01 - R 465.02

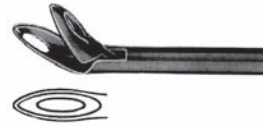

BLAKESLEY-WILDE
R 466.01
4.2 mm



R 467.01
3.6 mm

R 467.02
4.2 mm

R 467.03
5.0 mm

BLAKESLEY-WILDE
R 467.01 - R 467.03



STRÜMPEL-VOSS
R 468.01
3.6 mm

10 cm

10 cm

12 cm

11 cm

WEIL-BLAKESLEY
R 360.00 3.0 mm



R 360.01 3.6 mm



R 360.02 4.2 mm



R 360.03 4.8 mm



R 360.04 5.8 mm



1/1

WEIL-BLAKESLEY
R 362.00 3.6 mm



R 362.01 4.2 mm



R 362.02 4.8 mm



1/1

1/2

1/2

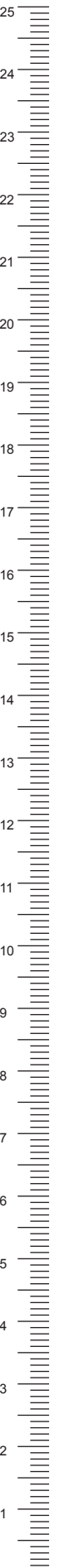

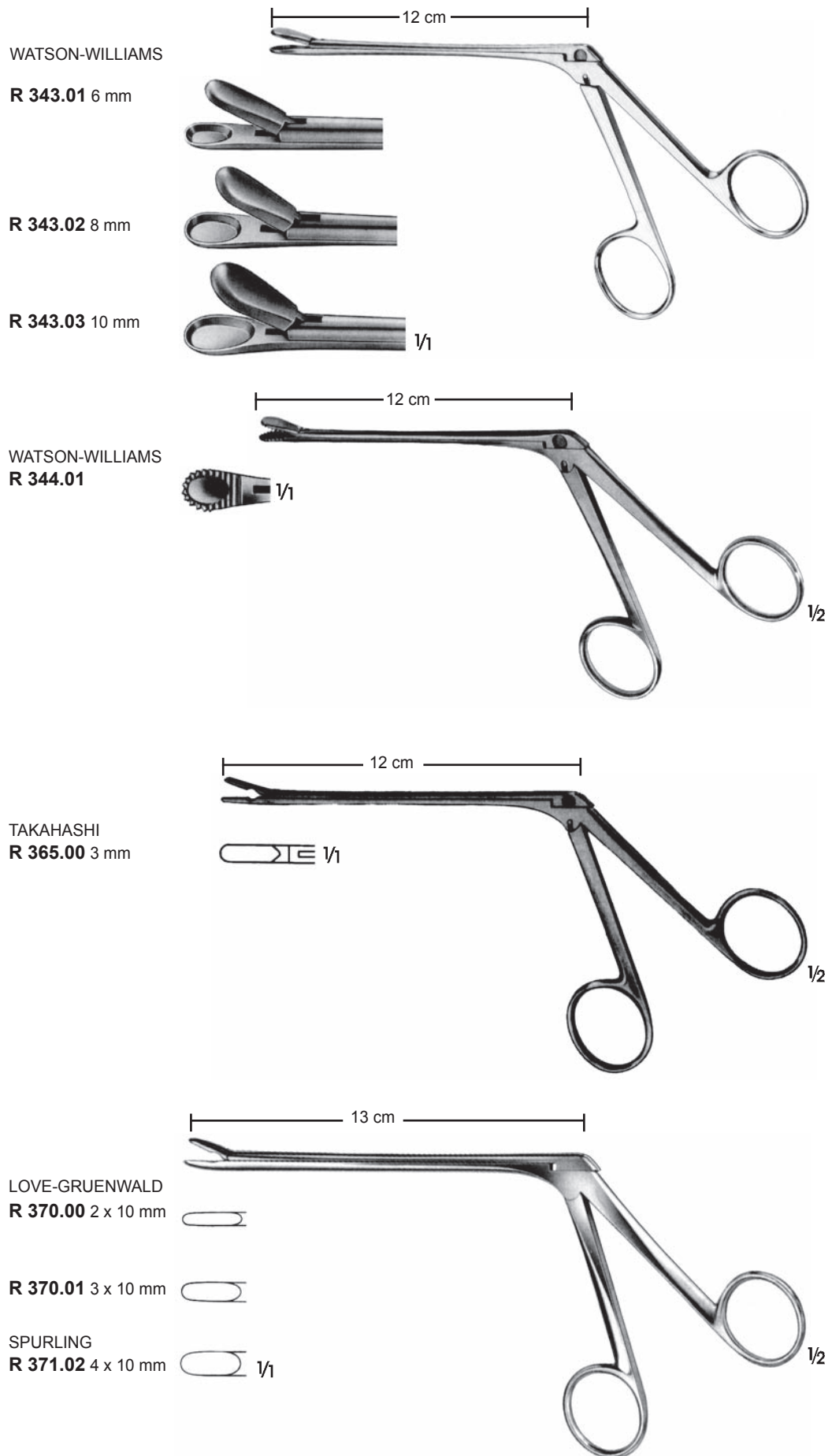

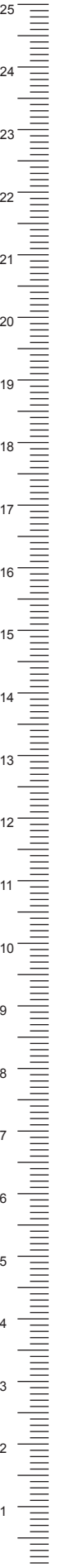
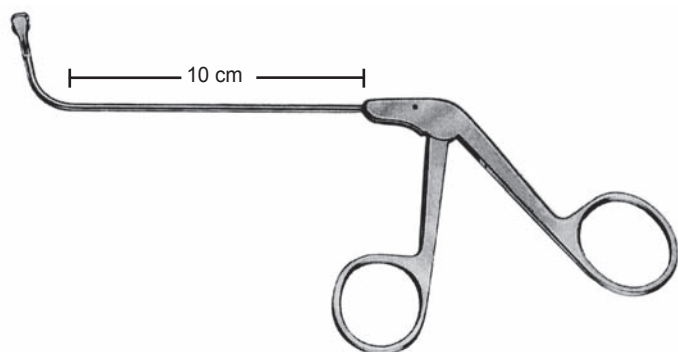
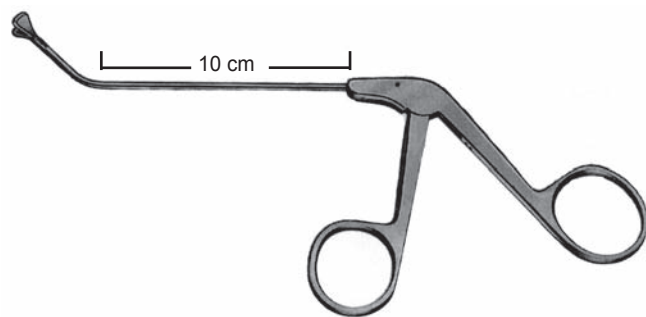
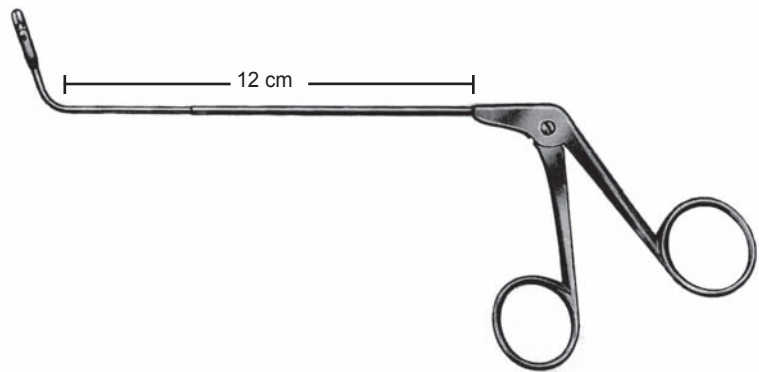
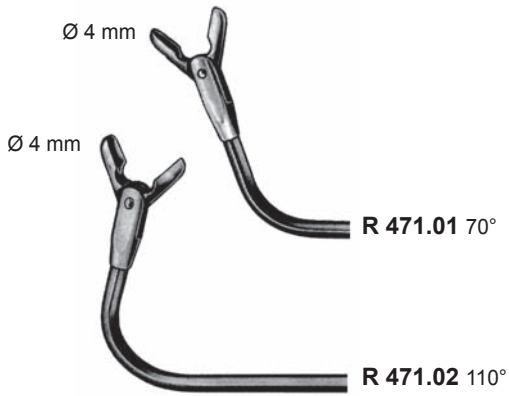
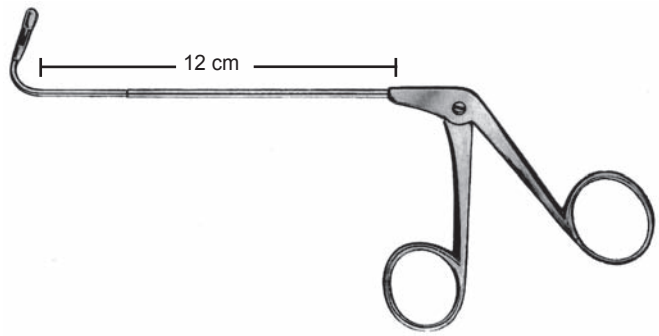



Oral Cerrahi, Adenoidektomi - Tonsilektomi, Larengoloji - Bronkoskopi, Özofagoskopi - Traketomi
Oral Surgery, Adenoidectomy - Tonsillectomy, Laryngology - Bronchoscopy, Oesophagoscopy - Tracheotomy



KROENIG
K 577.00
15 cm



MAYO
K 579.00
17 cm

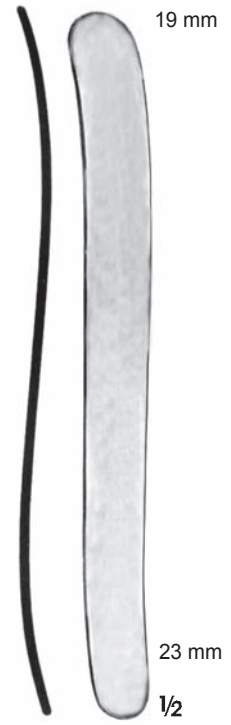

BUCHWALD
K 581.00
18 cm



K 580.00
14.5 cm

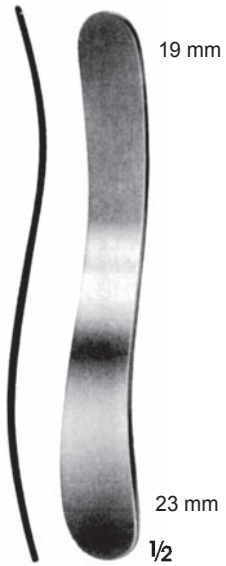

K 580.01
14 cm



K 576.00
14.5 cm



DOYEN
K 575.00 13 cm
K 575.01 16 cm



FRENZEL
K 585.00
16.5 cm



MARTIN
K 584.00
16.5 cm



STEMBERG
K 347.00 14 cm
K 347.01 16 cm
K 347.02 18 cm



BRÜNINGS
K 583.00
19 cm



YOUNG
E 124.00
17 cm

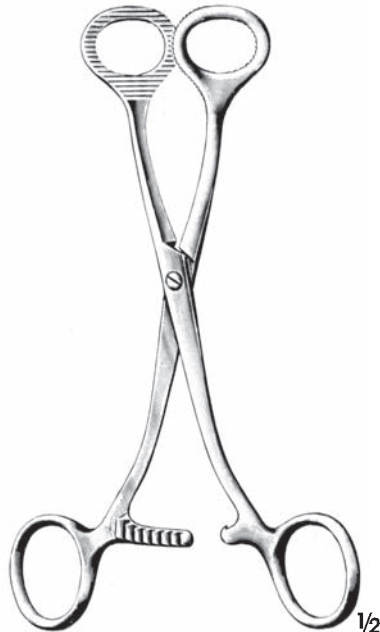

COLLIN
E 193.00
17 cm



GUY
E 188.00
19 cm





1/2
MARTIN-SIMPLEX
K 484.00
11 cm



1/2
BISHOP
K 486.00
13 cm



1/2
CAWOOD
K 485.00
15.5 cm



1/2
MORITZ-SCHMIDT
K 586.01
19 cm



MIDDELDORPF
K 480.00 - K 480.02



K 480.02
28 x 28 mm
23.5 cm



K 480.01
20 x 22 mm
21.5 cm



K 480.00
15 x 15 mm
22 cm

1/1



1/2
HARTMANN
K 587.00
15 cm



1/2
TOBOLD
K 588.00
16 cm



1/2
TOBOLD
K 595.01
14.5 cm



1/2
WIEDER
K 589.00 - K 589.01



K 589.00
14 cm



K 589.01
15 cm





SCHMID
L 199.00



1/2
HEISTER
L 206.00
13 cm

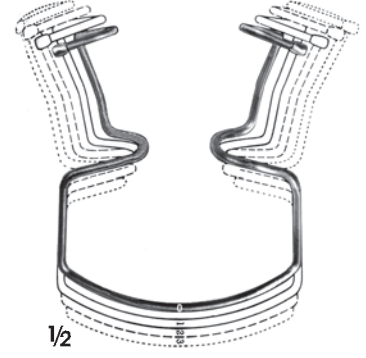

1/2
ORINGER
L 205.00 3'lü Set/3' Set
(L 205.01 - L 205.02 - L 205.03)
L 205.01 Şekil 1 / Fig.1
L 205.02 Şekil 2 / Fig.2
L 205.03 Şekil 3 / Fig.3

L 205.04 Şekil 0 / Fig.0
Çocuklar için/For children



1/2
DENHARDT
L 204.00
Değiştirilebilir silikon parçalı
Silicon inserts interchangeable
12.5 cm



1/2
FERGUSSON-ACKLAND
L 200.00
14.5 cm



1/2
ROSER-KÖNIG
L 201.00
16 cm

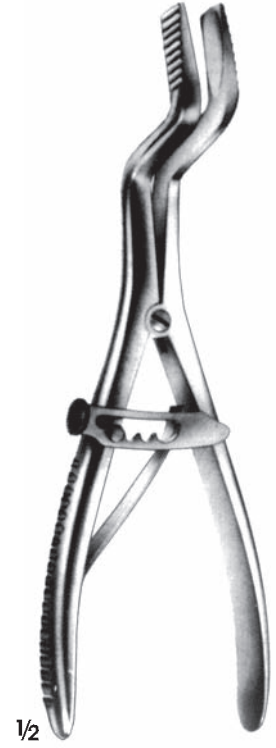

1/2
ROSER-KÖNIG
L 203.00
18.5 cm



1/2

MOLT
L 209.00
10 cm



1/2

DOYEN-COLLIN
L 208.00
12 cm



1/2

DOYEN-JANSEN
L 207.00
14 cm



WHITEHEAD
L 150.01 9 cm
L 150.02 11 cm
L 150.03 13 cm
L 150.04 15 cm

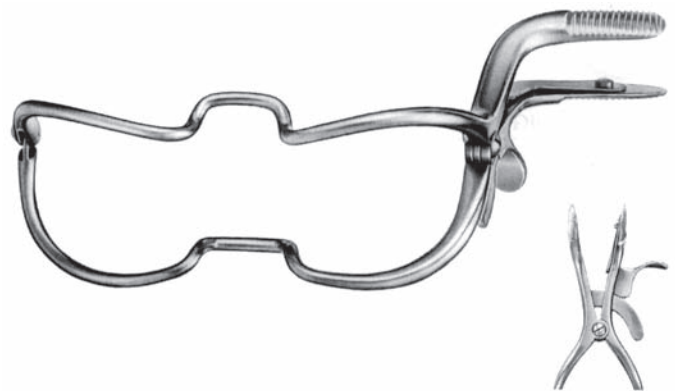

WHITEHEAD-JENNINGS
L 152.00 9 cm
L 152.01 11 cm
L 152.02 13 cm
L 152.03 15 cm

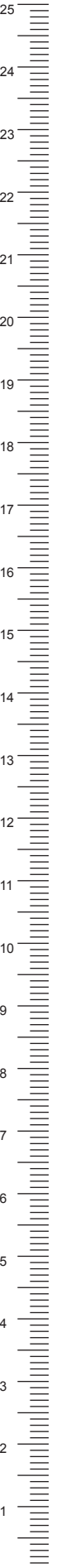



1/2

DAVIS-BOYLE

L 162.00 Çocuklar için/For children

L 162.01 Gençler için/For adolescents

Sayfa 167, 168, 169'deki bütün dil basacaklarına uygun

Suitable for all tongue depressors as shown on pages 167, 168, 169



1/2

McIVOR

L 165.00

Sayfa 167, 168, 169'deki bütün dil basacaklarına uygun

Suitable for all tongue depressors as shown on pages 167, 168, 169



1/2

DAVIS-BOYLE

L 161.00 B y kler i in/For adults

Sayfa 167, 168, 169'deki b t n dil basacaklarına uygun

Suitable for all tongue depressors as shown on pages 167, 168, 169



1/2

DAVIS-MEYER

L 160.00

Sayfa 167, 168, 169'deki b t n dil basacaklarına uygun

Suitable for all tongue depressors as shown on pages 167, 168, 169



L 159.00

L 160.00 i in damak bleydi,

Palate blade to use with L 160.00

Di siz hastalarda kullanılır

For teethless patients



1/2

DINGMAN
L 155.02
Küçük/Small
55 x 25 mm

DINGMAN
L 155.03
Orta boy/Medium
60 x 27 mm

DINGMAN
L 155.04
Büyük/Large
70 x 30 mm

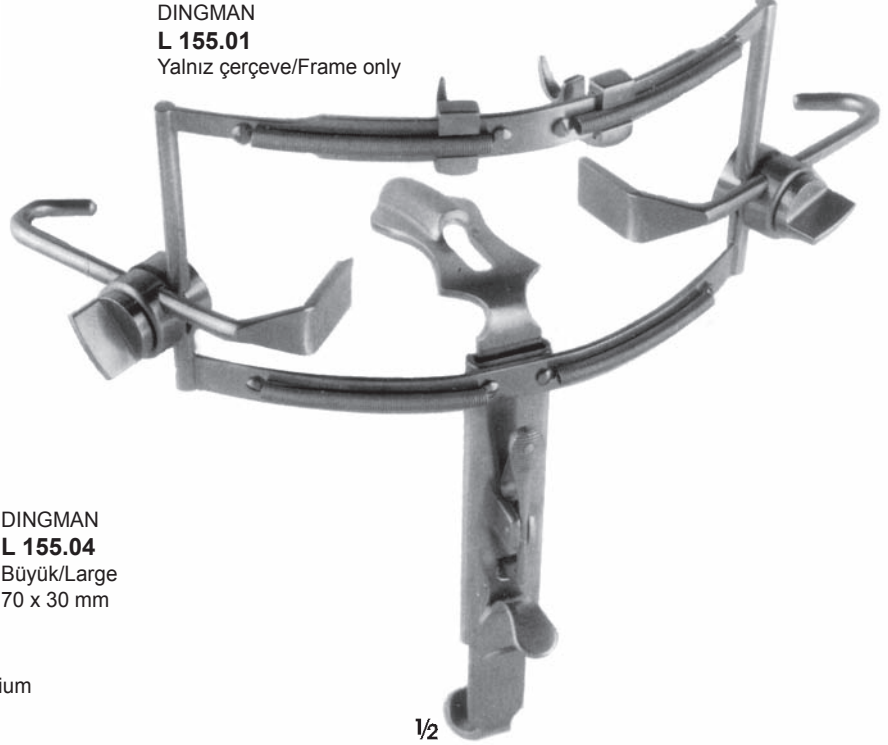

1/2

DINGMAN
L 155.00
Komple/Complete
(L 155.01 - L 155.02 - L 155.03 - L 155.04)

DINGMAN
L 155.01
Yalnız çerçeve/Frame only



1/2

KILNER-DOUGHTY
L 158.00
Sayfa 167, 168, 169'deki bütün dil
basacaklarına uygun
Suitable for all tongue depressors as
shown on pages 167, 168, 169



L 225.01
67 X 29 mm

L 225.02
75 X 33 mm

L 225.03
85 X 38 mm

L 225.04
92 X 40 mm

L 225.05
100 X 46 mm

RUSSEL-DAVIS
L 227.01 - L 227.03
Sayfa 166, 167'deki bütün
çerçevelere uygun
Suitable for all frames
on page 166, 167



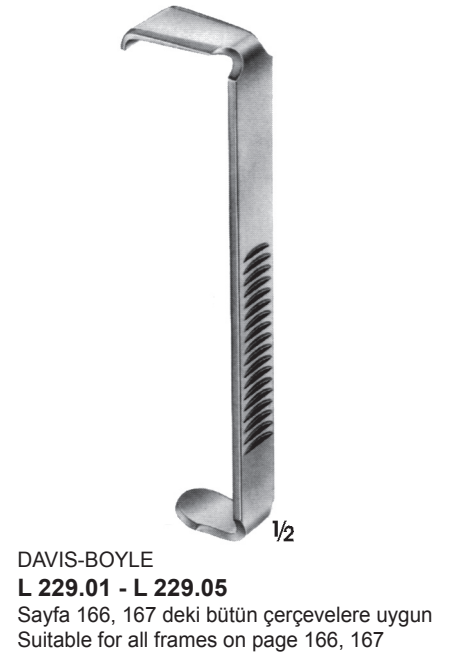

McIVOR
L 228.01 - L 228.03
Sayfa 166, 167 deki bütün çerçevelere uygun
Suitable for all frames on page 166, 167



GAST
L 226.01 - L 226.03
Sayfa 166, 167 deki bütün çerçevelere uygun
Suitable for all frames on page 166, 167



L 227.01
57X18 mm

L 227.02
67X22 mm

L 227.03
75X25 mm

RUSSEL-DAVIS
L 227.01 - L 227.03

Sayfa 166, 167 deki bütün çerçevelere uygun
Suitable for all frames on page 166, 167



L 223.01

L 223.03

L 223.05

L 223.07

DAVIS-MEYER

L 223.01 70 x 29 mm

L 223.02 75 x 30 mm

L 223.03 80 x 31 mm

L 223.04 85 x 32 mm

L 223.05 95 x 33 mm

L 223.06 100 x 33 mm

L 223.07 105 x 34 mm

Sayfa 166, 167 deki bütün çerçevelere uygun
Suitable for all frames on page 166, 167

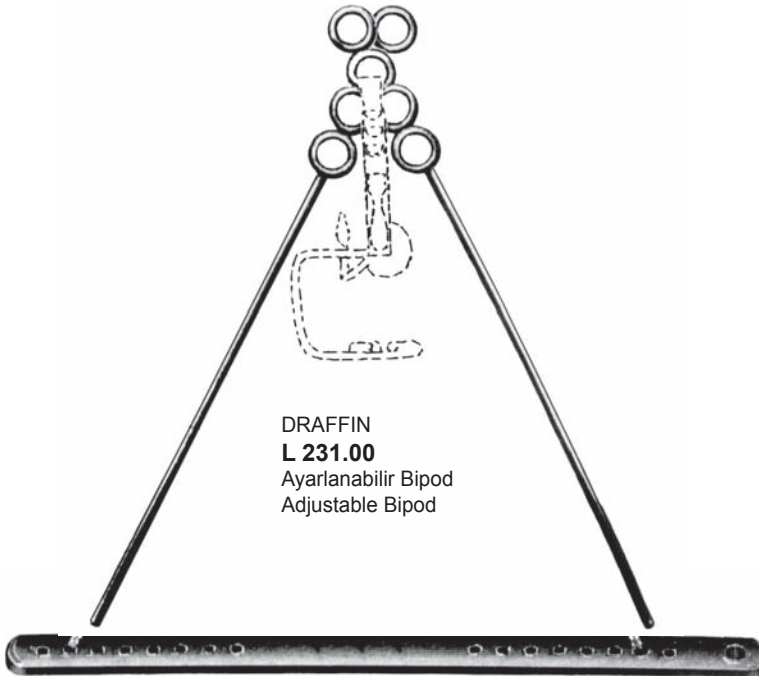

DRAFFIN
L 231.00
Ayarlanabilir Bipod
Adjustable Bipod

MAGAURAN
L 232.00 48.3 cm

Bipod Paleti/Palet for holding Bipod



NEGUS
L 230.00
Göğüs desteği
Chest Support



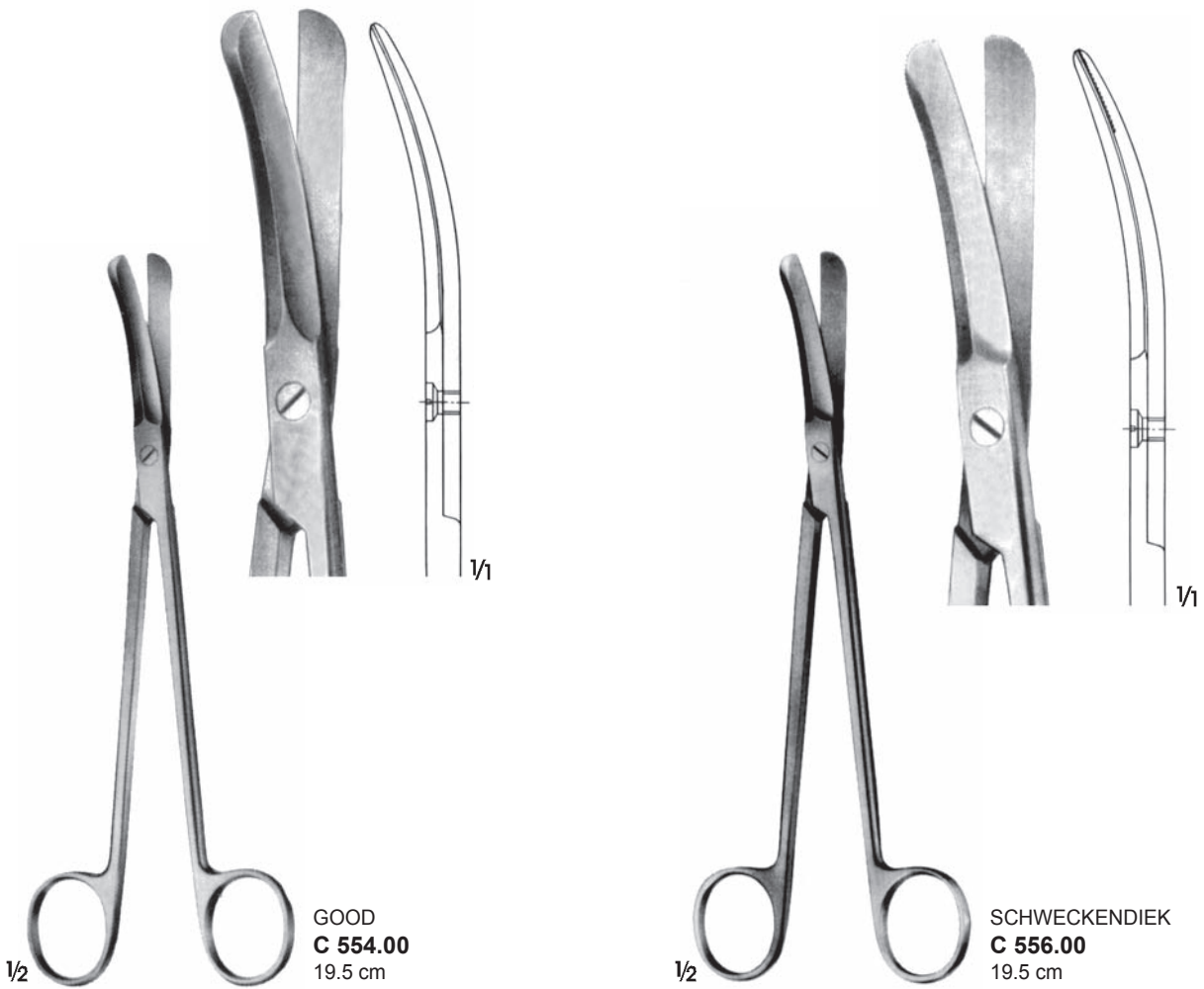
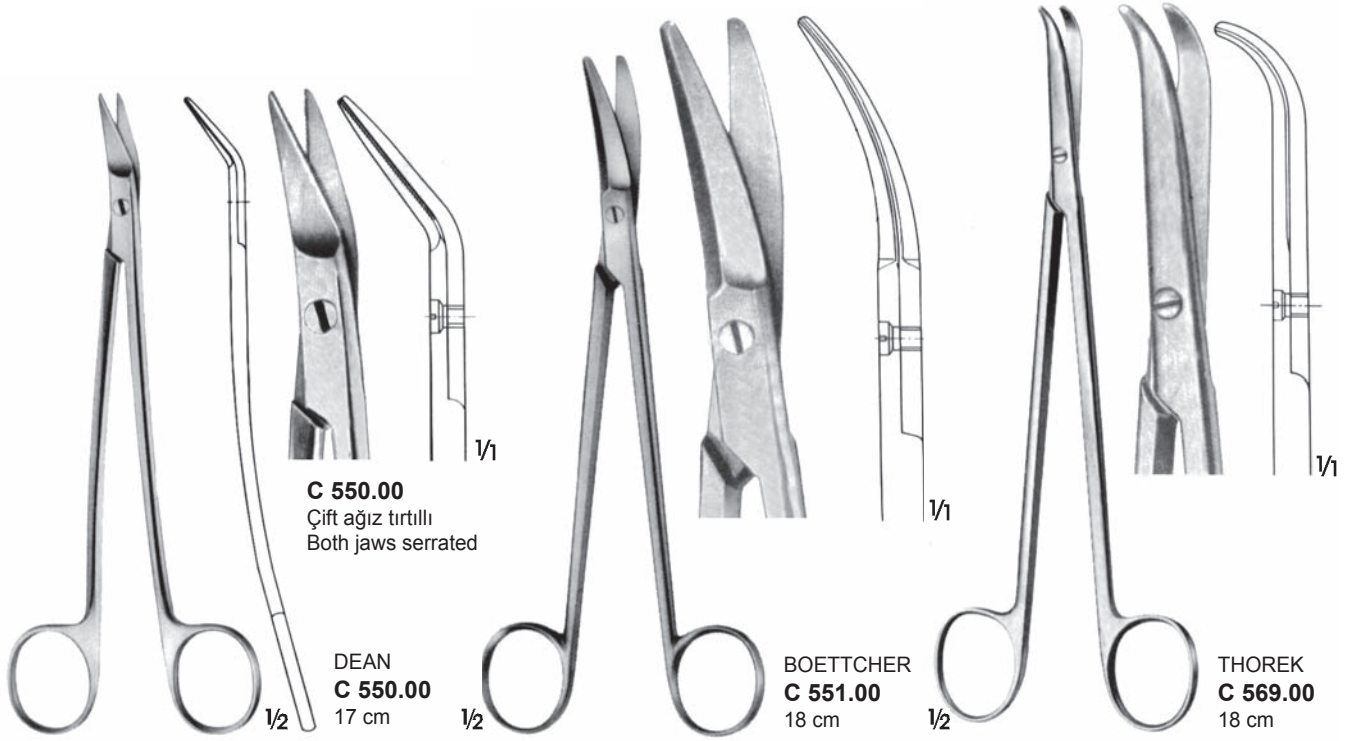

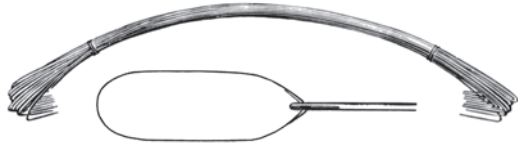

B 580.00 Ø 0.3 mm
B 580.01 Ø 0.5 mm
12'lik paket/Package of 12 pcs



B 585.00 Ø 0.3 mm
10 metrelik tel bobin
Wire coils of 10 meters



BRÜNINGS
B 241.00
27 cm
1/2



EVES
B 242.01
25 cm
1/2



EVES
B 240.00
25 cm
1/2





DUPLAY
E 030.00
21 cm

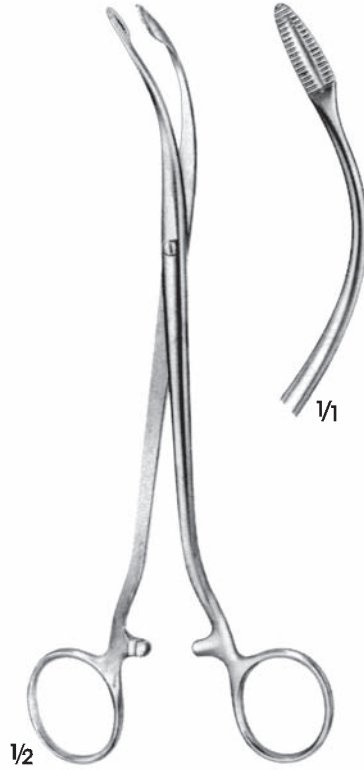

DUPLAY
E 031.00
19 cm

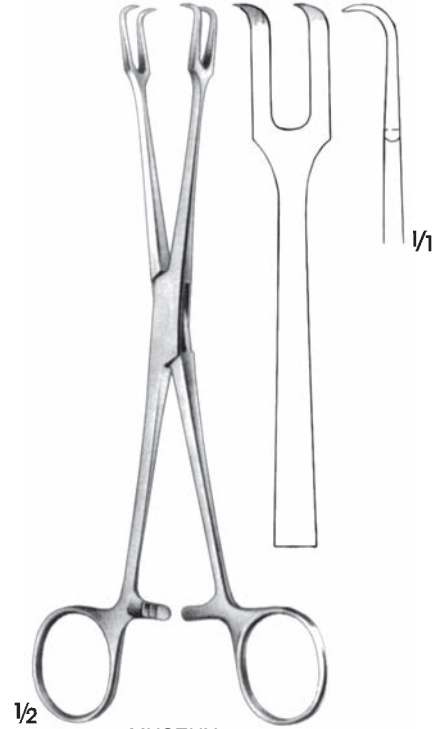

MUSEUX
E 165.00
20 cm



ABRAHAM
E 224.00
20.5 cm



BLOHMKE
E 225.00
20.5 cm



THILENIUS
E 230.00
19 cm

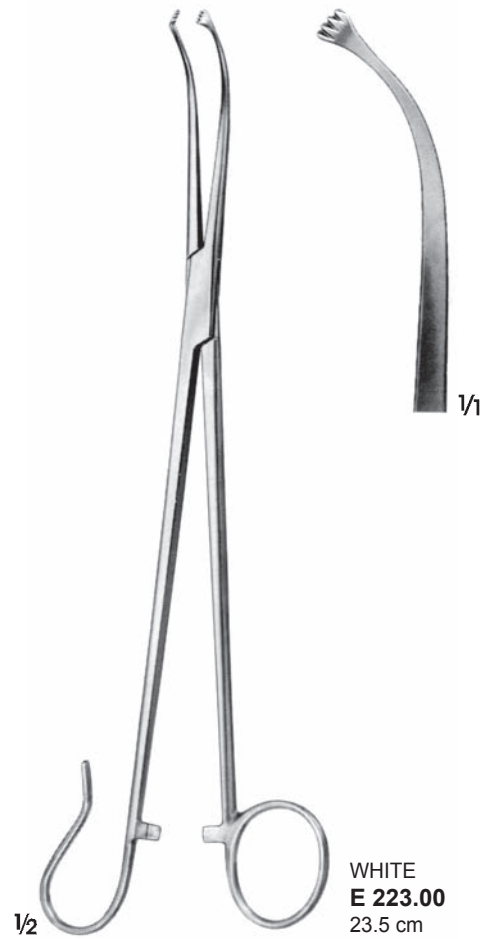
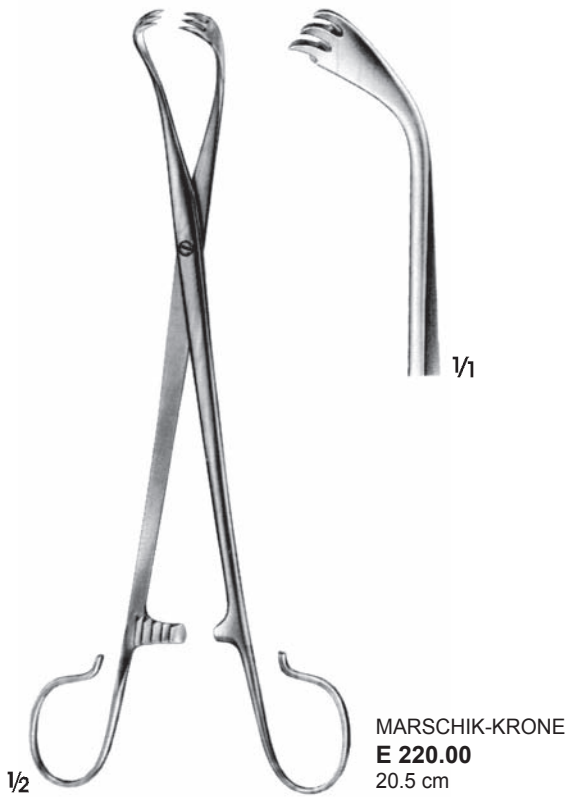
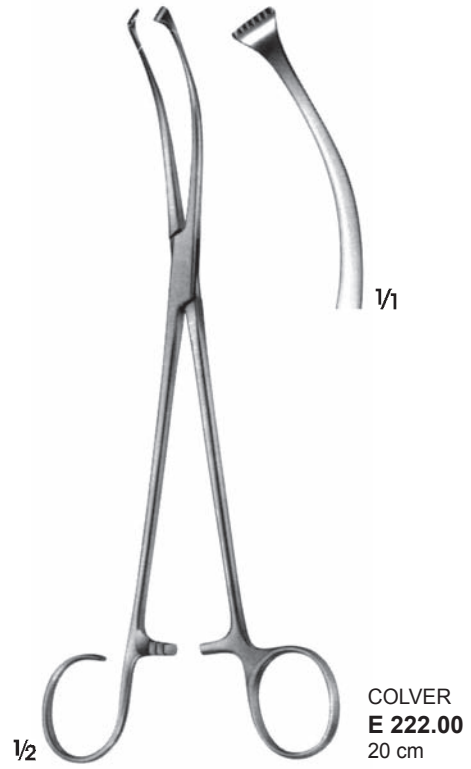
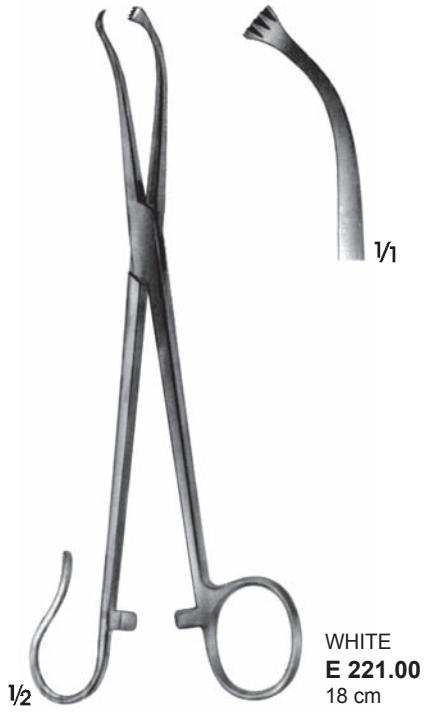
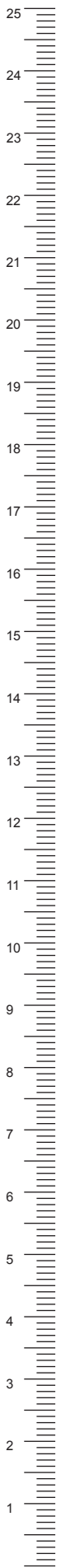

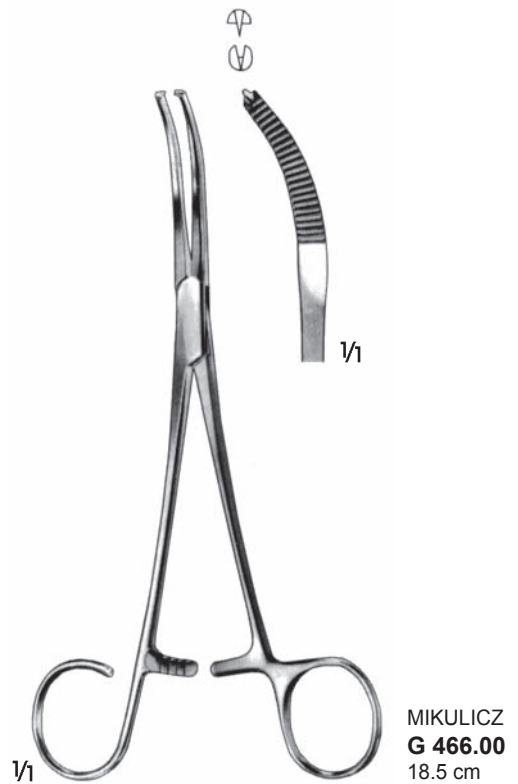
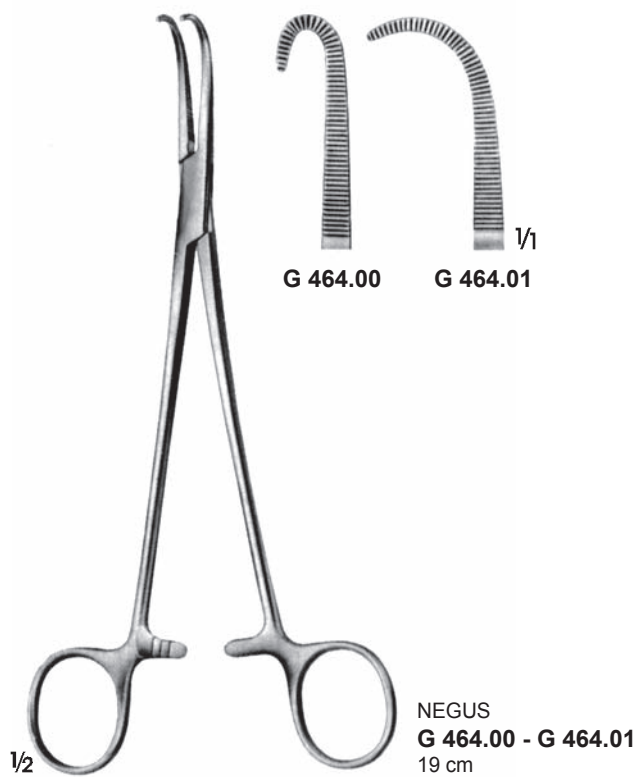
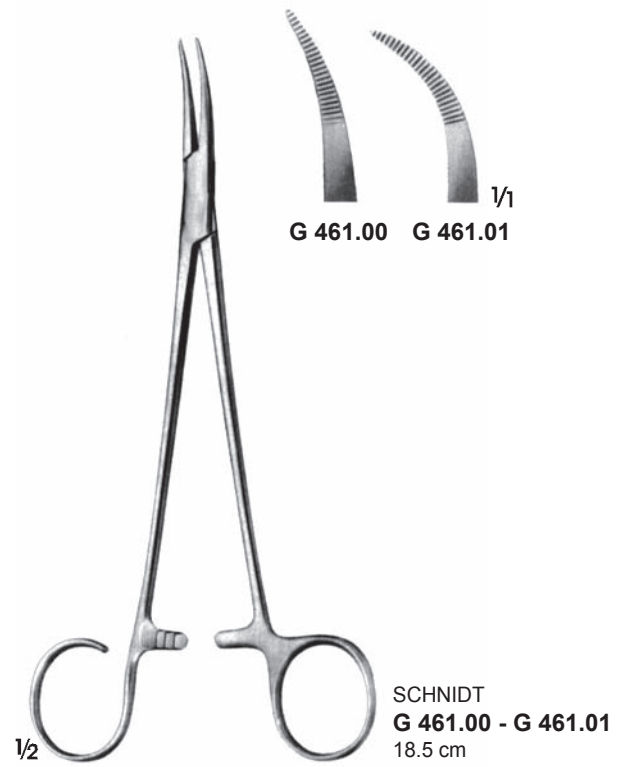
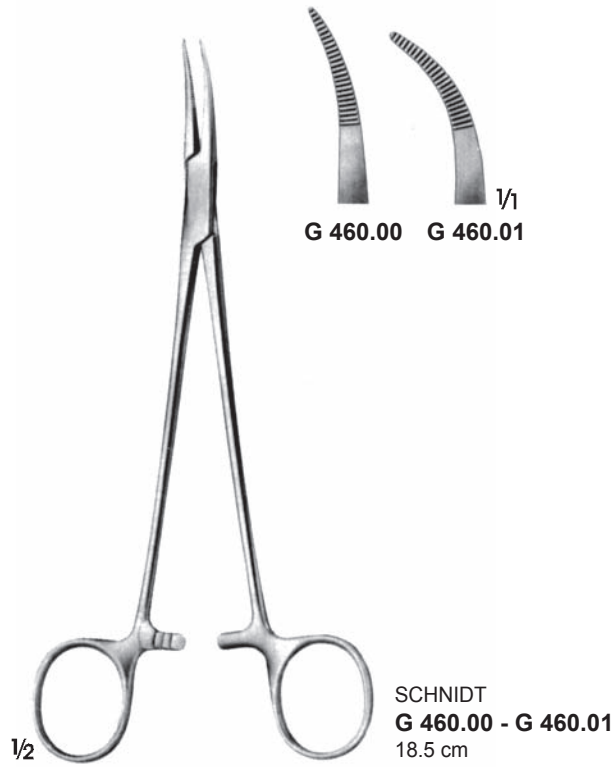



$\frac{1}{2}$ **FOWLER**
B 122.00
20 cm

$\frac{1}{2}$ **ABRAHAM**
B 125.00
21.5 cm

$\frac{1}{2}$ **BRÜNINGS**
B 126.00
21.5 cm

Olive
Ø 9 mm
 $\frac{1}{2}$ **LOPEZ-REINKE**
J 365.00
23.5 cm

6 mm
 $\frac{1}{2}$ **HURD**
M 205.02
21.5 cm

10 mm
 $\frac{1}{2}$ **HURD**
M 205.04
21.5 cm

12 mm
 $\frac{1}{2}$ **HENKE**
M 208.02
23.5 cm

17 mm
 $\frac{1}{2}$ **HENKE**
M 208.04
23.5 cm



CLAUS van EICKEN
K 155.00
 21 cm



13 X 6 mm

SCHONBORN
K 270.00
 20 cm



NAGER
K 208.00
 23 cm



CLAUS van EICKEN
F 451.00
 25 cm



NEGUS
T 060.00
 20.5 cm



LUNIATSCHEK
N 055.00
 18 cm



BECKMANN
N 380.00 - N 380.05
20 cm

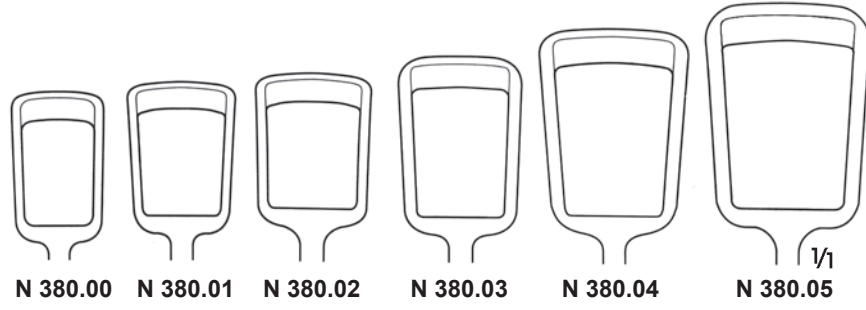

BECKMANN
N 381.01 - N 381.04
20 cm

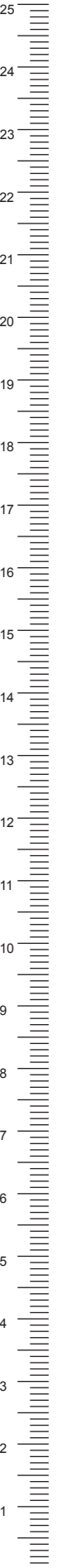
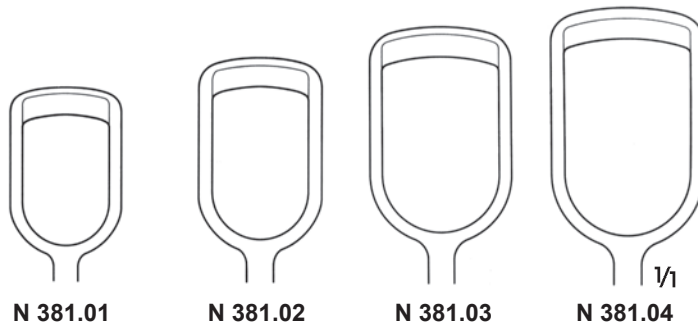



BECKMANN
N 382.01 - N 382.06
22 cm

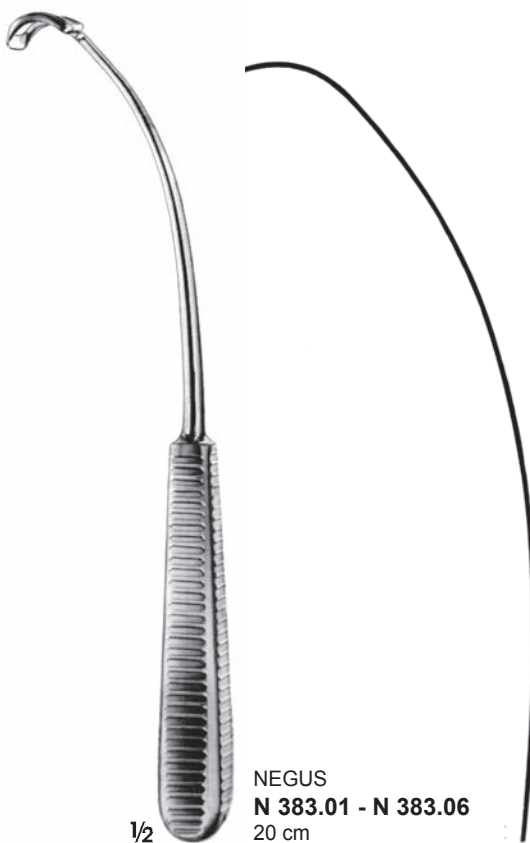
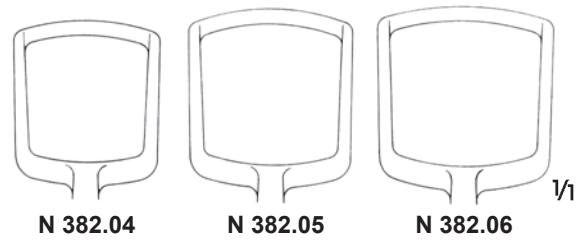
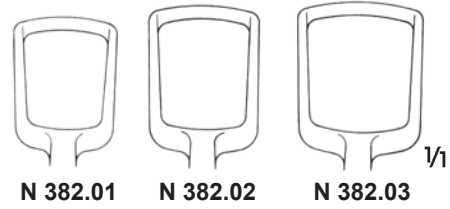

NEGUS
N 383.01 - N 383.06
20 cm

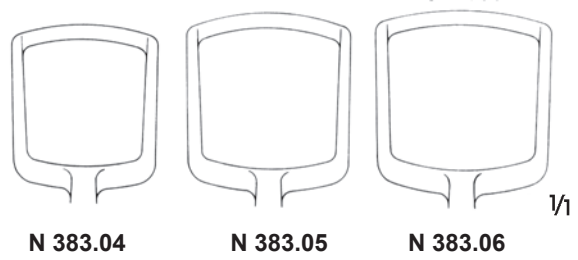
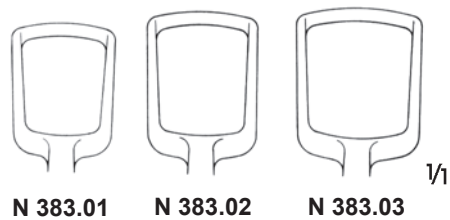



ST. CLAIR-THOMPSON
N 384.01 - N 384.06



N 384.01 8.5 mm
21 cm



N 384.02 10 mm
21 cm



N 384.03 13 mm
21 cm

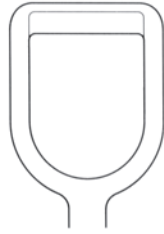

N 384.04 15 mm
21.5 cm

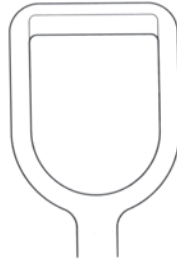

N 384.05 16.5 mm
21.5 cm

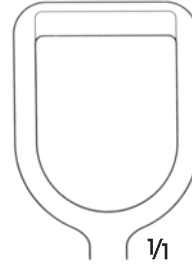

N 384.06 18 mm
21.5 cm



LA FORCE
N 385.01
N 385.02
N 385.03
23 cm

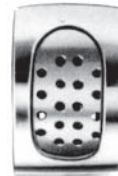

N 385.01



N 385.02



N 385.03

N 386.01
N 386.02
N 386.03

Yalnız yedek bleydler
Spare blades only

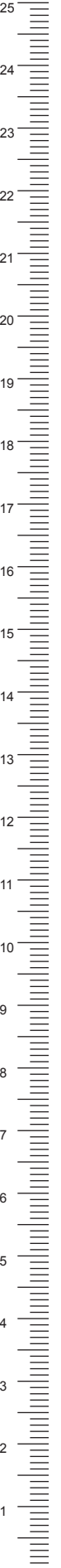

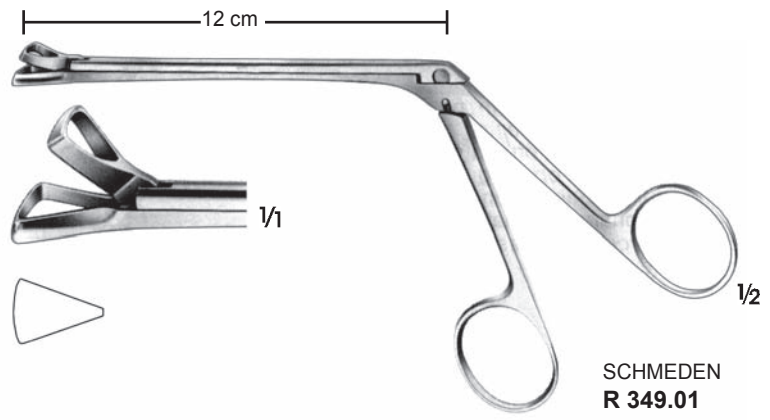
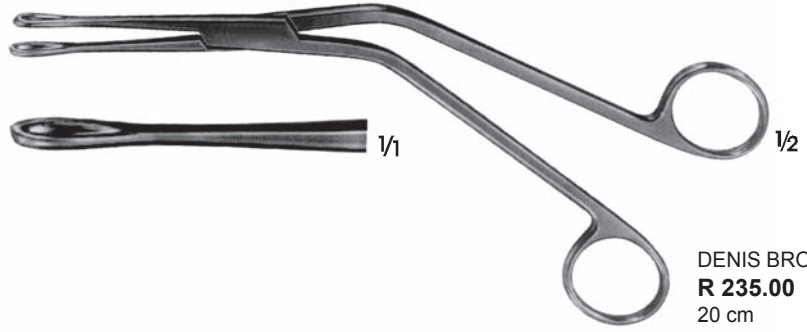

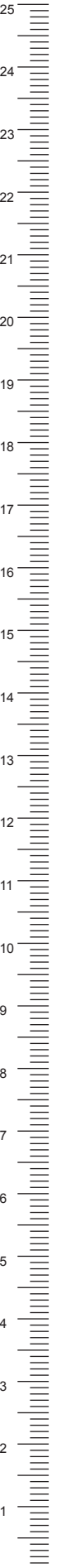
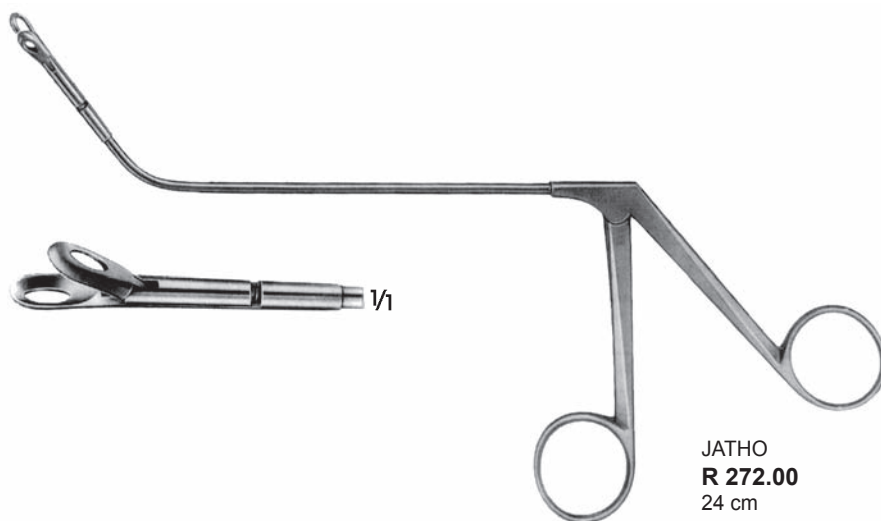
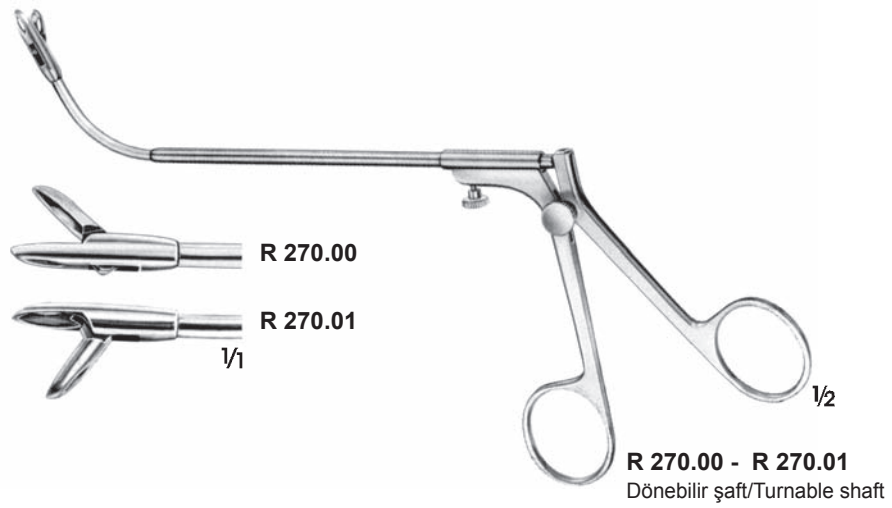
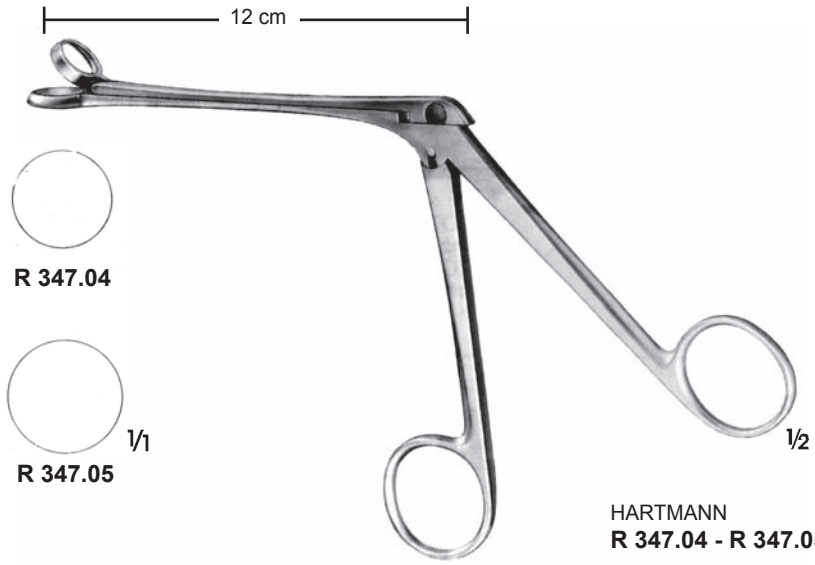



A 300.01
A 302.01
Fig. 000
Ø 6 mm



A 300.02
A 302.02
Fig. 00
Ø 8 mm



A 300.03
A 302.03
Fig. 0
Ø 10 mm



A 300.04
A 302.04
Fig. 1
Ø 12 mm



A 300.05
A 302.05
Fig. 2
Ø 14 mm



A 300.06
A 302.06
Fig. 3
Ø 16 mm



A 300.07
A 302.07
Fig. 4
Ø 18 mm

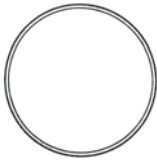

A 300.08
A 302.08
Fig. 5
Ø 20 mm



A 300.09
A 302.09
Fig. 6
Ø 22 mm



A 300.10
A 302.10
Fig. 7
Ø 24 mm

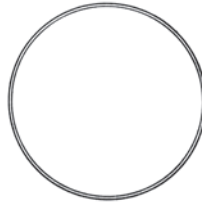

A 300.11
A 302.11
Fig. 8
Ø 26 mm

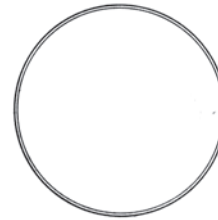

A 300.12
A 302.12
Fig. 9
Ø 28 mm

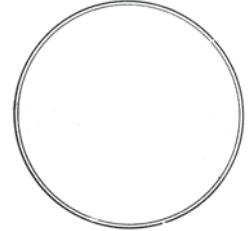

A 300.13
A 302.13
Fig. 10
Ø 30 mm



A 308.01
Ø 12 mm



A 308.02
Ø 14 mm

A 308.03 **A 308.04**
Yedek aynalar
Spare mirrors, only



1/2



1/2



1/2



1/2



1/2

A 300.01 - A 300.13
Altıgen saplı Laringel
aynalar
Laryngeal mirrors with
Hexagonal handle
18 cm

A 302.01 - A 302.13
Laringel aynalar
Laryngeal mirrors
12 cm

A 304.00
Ayna sapı
Mirror handle
11 cm

A 306.00
Ayna sapı
Mirror handle
10.5 cm

MICHEL
A 308.01 - A 308.02
Rinoskopik aynalar
(Değiştirilebilir aynalar)
Rhinoscopic mirrors,
with interchangeable mirror inserts
25 cm

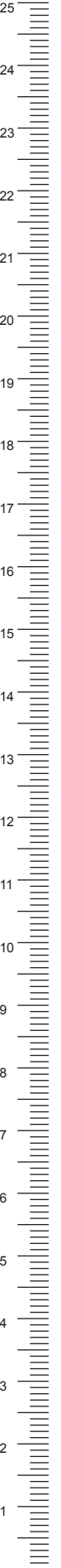
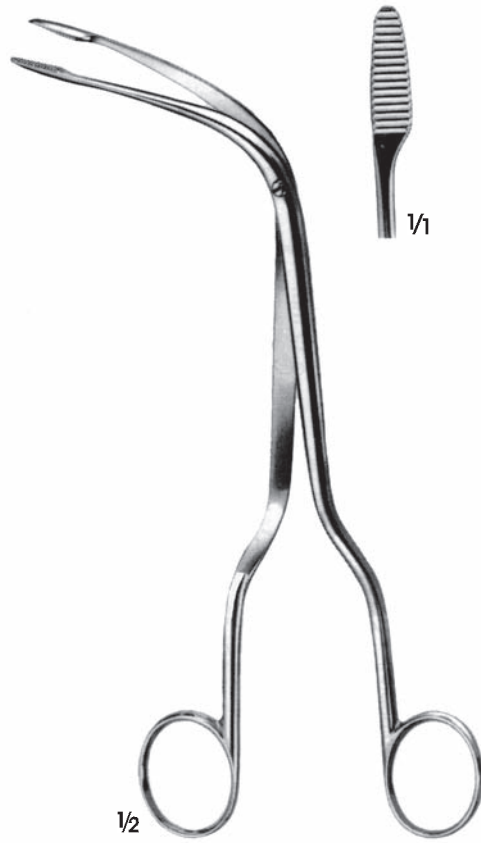
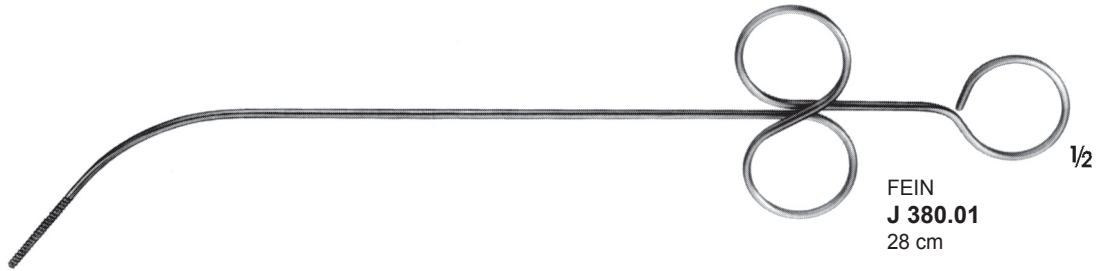

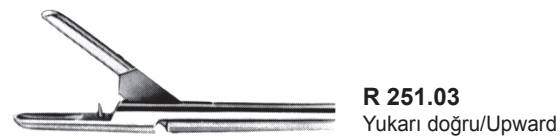
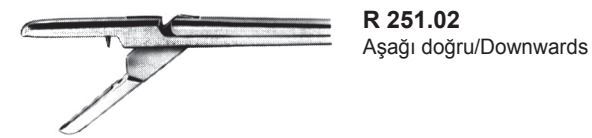
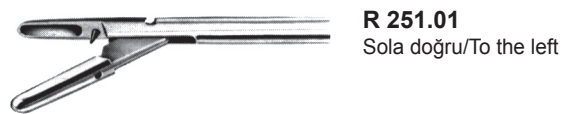
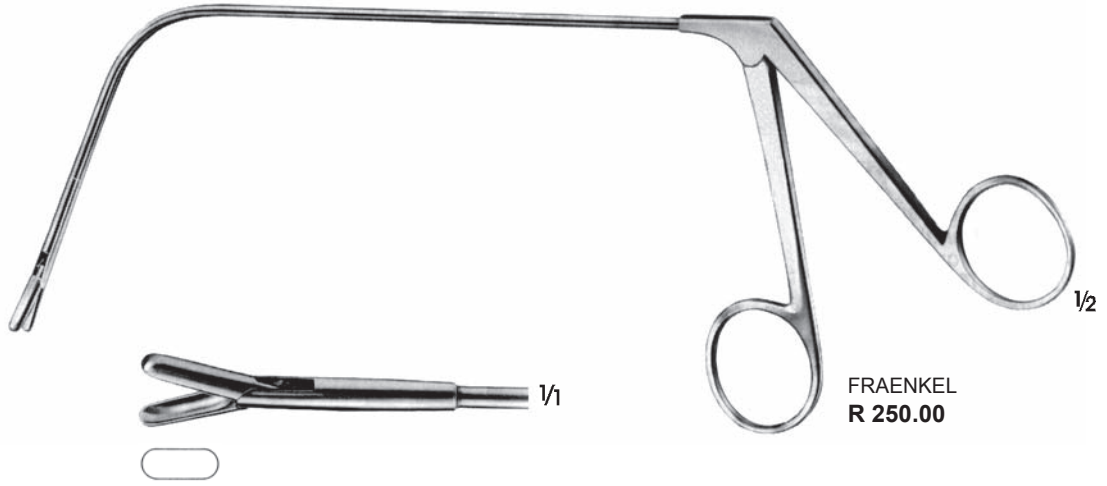

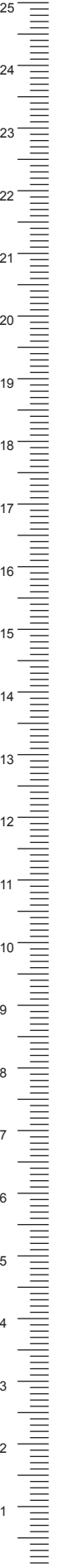
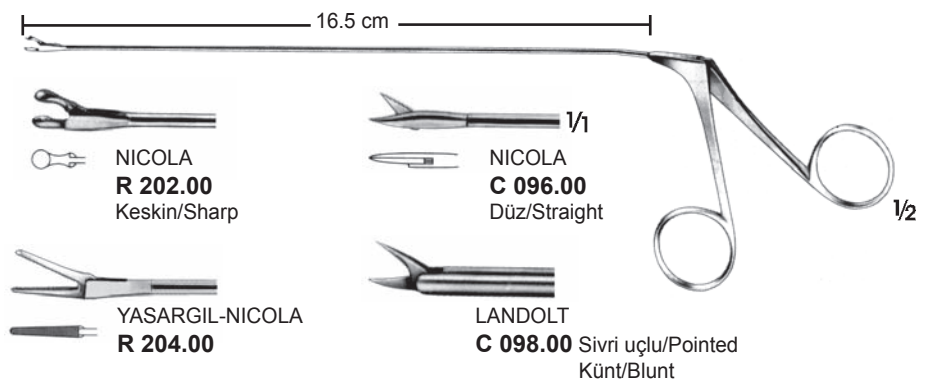
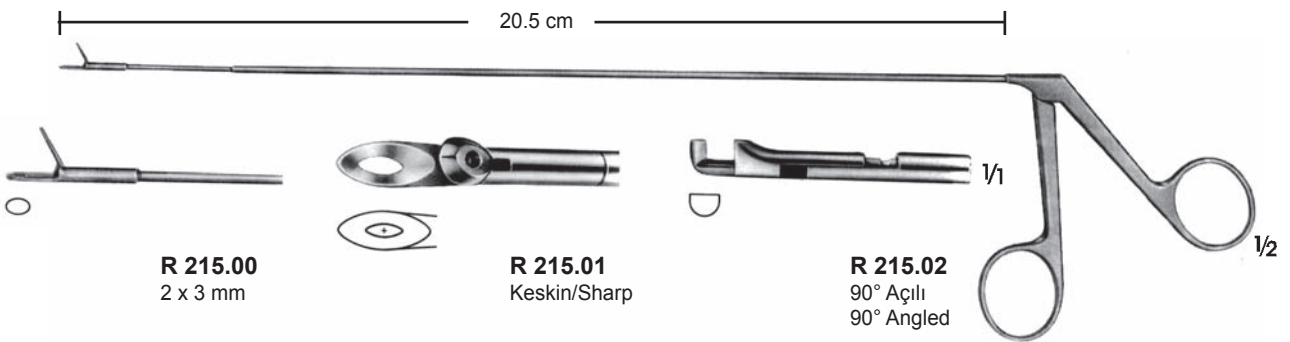
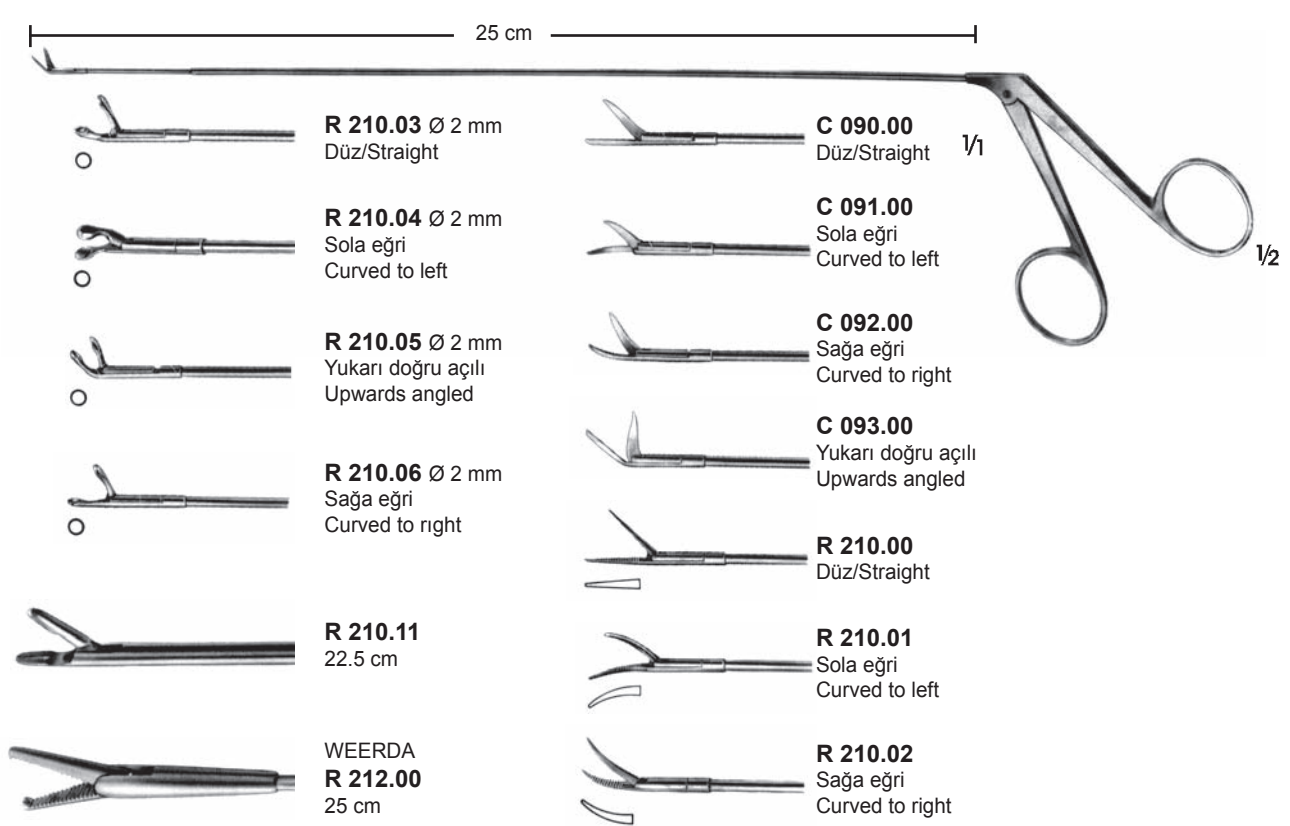

R 795.00 - R 796.00 üniversal sapları ve R 762.01 - R 763.02 tüpleri için uçlar
Tips for universal Handles R 795.00 - R 796.00 and Tubes R 762.01 - R 763.02



STRUYCKEN
R 779.01

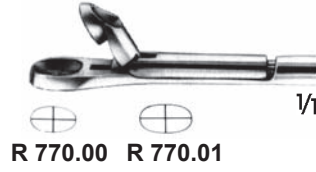

KRAUSE
R 770.00 - R 770.01



R 782.01



LANGE
R 771.01



KAHLER
R 784.01



SCHEINMANN
R 772.00



EICKEN
R 785.01

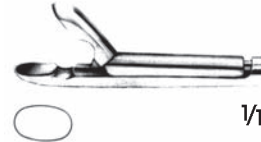

LANGE
R 773.01



FRAENKEL
R 786.01



SCHUMACHER
R 774.00



FRAENKEL
R 787.01

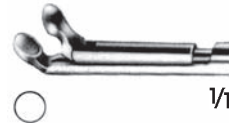

BRUNINGS
R 775.01

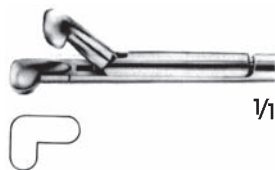

SCHINMANN
R 788.01



CORDES
R 778.00



BRUNINGS
R 789.01 - R 789.03



CORDES
R 778.01

R 789.01 Ø 2 mm
R 789.02 Ø 3 mm
R 789.03 Ø 4 mm



ROSENBERG
R 777.00



R 795.00
Üniversal sap
Universal handle
14 cm

1/2



HUBER
R 796.00
Üniversal sap
Universal handle
14 cm

1/2

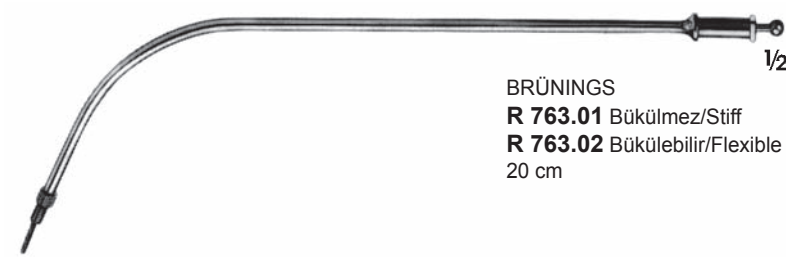

BRÜNING'S
R 763.01 Bükülmez/Stiff
R 763.02 Bükülebilir/Flexible
20 cm

1/2



BRÜNING'S
R 762.01 20 cm
R 762.02 25 cm
R 762.03 30 cm
R 762.04 35 cm
R 762.05 40 cm
R 762.06 50 cm
Uzatma shaftı/Extension cannulas

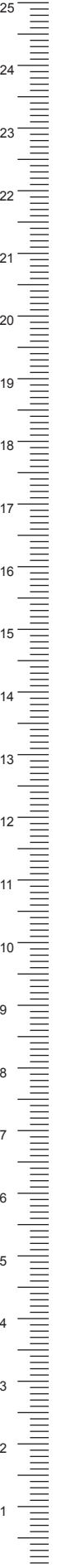



B 255.00
Kesici teli olarak B 580.00 kullanılır.
B 580.00 Uses as snare wires

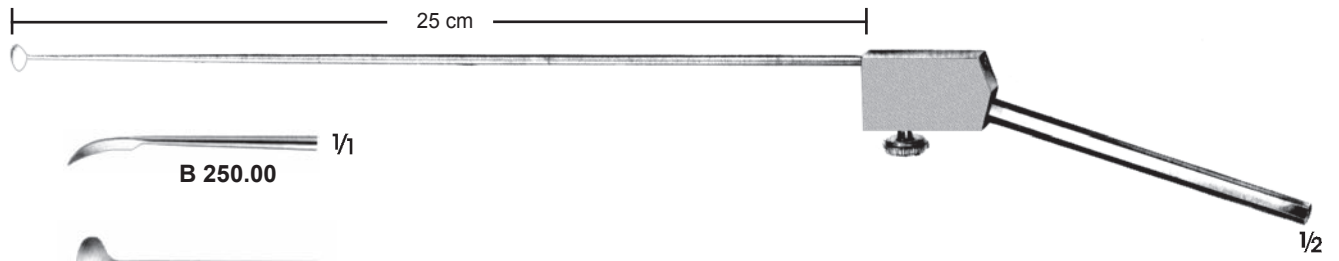

B 250.00



B 250.01



B 250.02



B 250.03 45°
Ø 3.5 mm



B 250.04 90°
Künt/Blunt



B 250.05 30°
Geriye doğru eğri
Backwards curved



B 250.06



B 250.08
B 250.00 - B 250.06 için sap
Handle for use with Instru-
ments B 250.00 - B 250.06

T 070.00
Komple/Complete
Yetişkinler ve çocuklar için
For adults and children

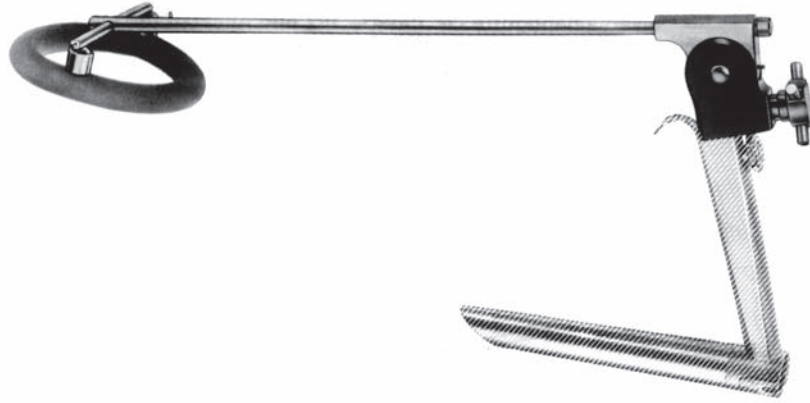

T 070.04 18 cm
Yetişkinler için, büyük boy
For adults, large size



T 070.03 18 cm
Yetişkinler için, orta boy
For adults, medium size



T 070.02 18 cm
Gençler için, Küçük boy
For adolescents, small size



T 070.01 13 cm
Çocuklar için
For children

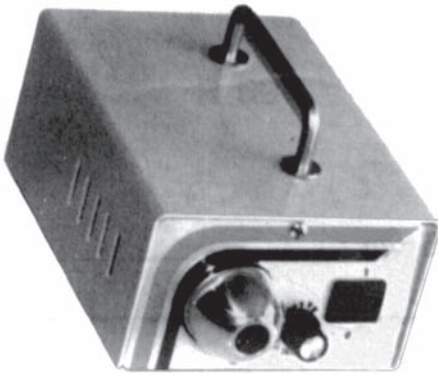

Z 400.00
250 Vat, hafif kaynak
250 watts, light source



Z 401.00 Ø 3.5 mm 180 cm
Z 401.01 Ø 4.8 mm 250 cm
Fiber optik ışık taşıyıcı
Fiber optic light transmitter

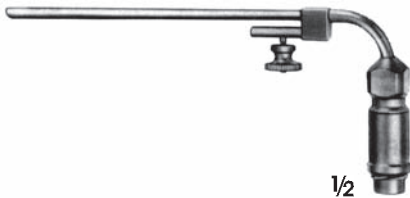

T 070.05
T 070.01 ile kullanılır.
To be used with T 070.01



T 070.06
T 070.02, T 070.03, T 070.04 ile kullanılır.
To be used with T 070.01, T 070.03, T 070.04

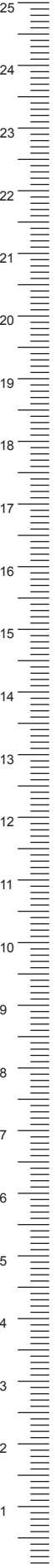

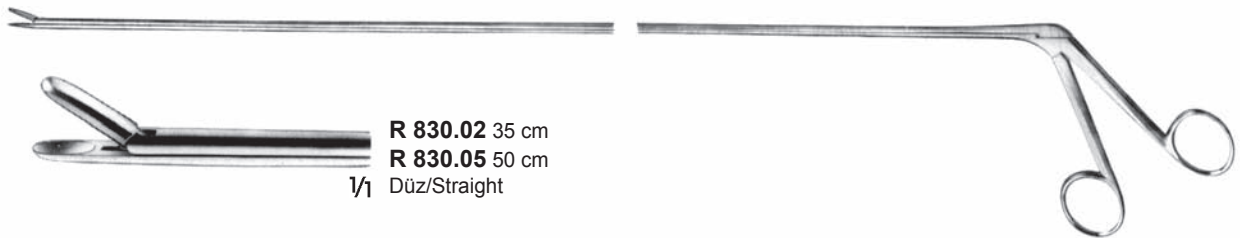
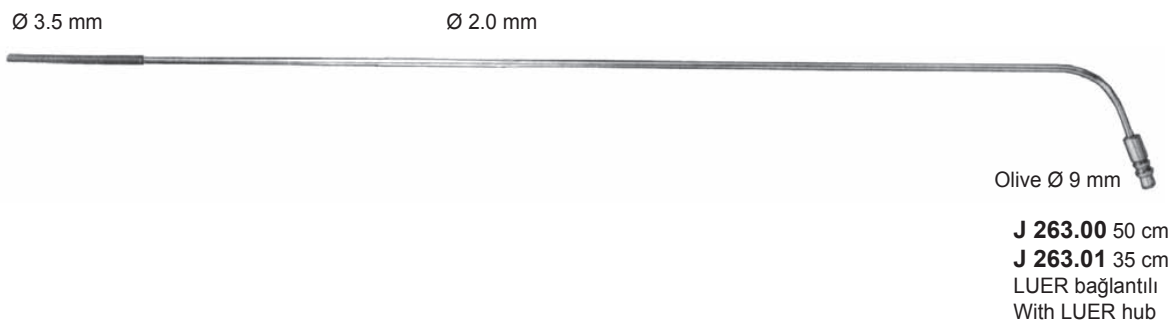
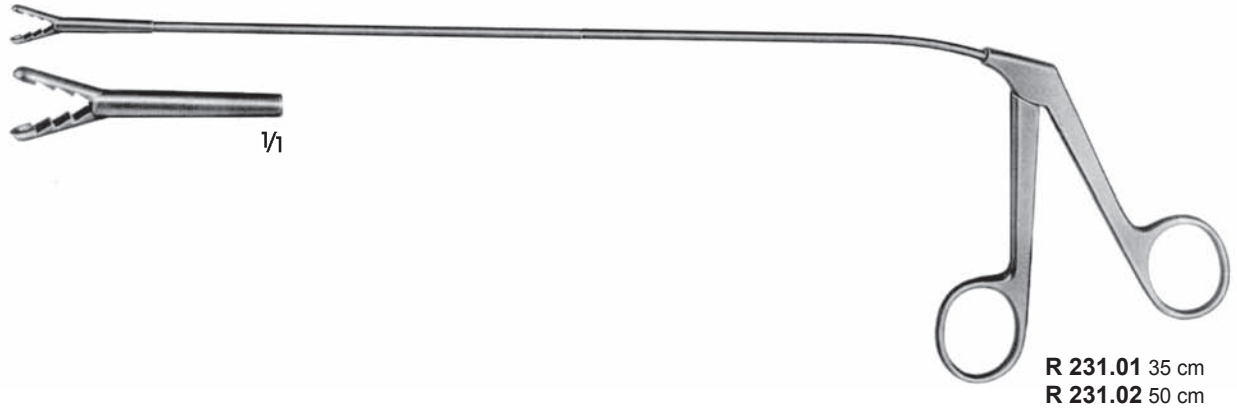

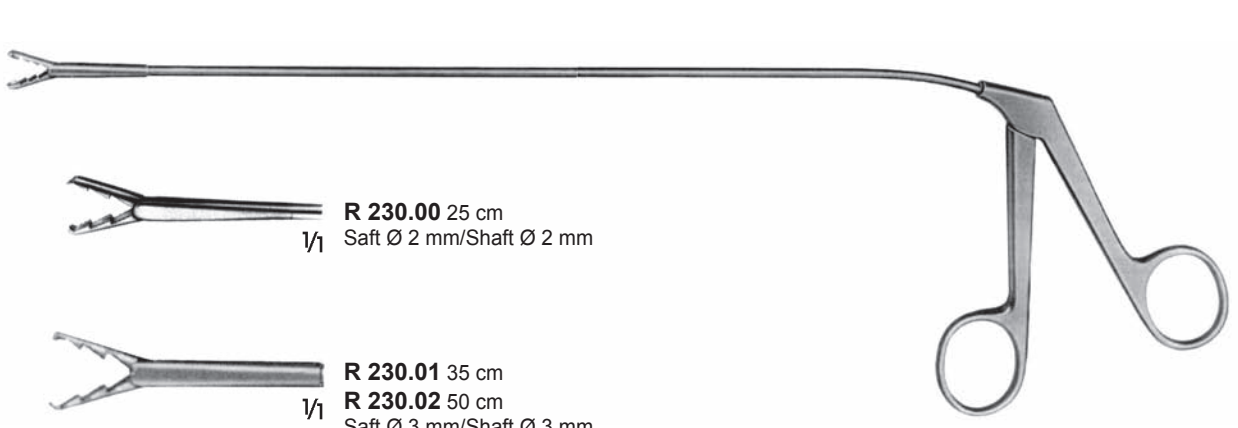

R 230.00 25 cm
Saft Ø 2 mm/Shaft Ø 2 mm

R 230.01 35 cm
R 230.02 50 cm
Saft Ø 3 mm/Shaft Ø 3 mm

R 231.00 25 cm
Saft Ø 2 mm/Shaft Ø 2 mm

Ø 3 mm **R 232.00** 25 cm
Saft Ø 2 mm/Shaft Ø 2 mm

Ø 5 mm **R 232.01** 35 cm
R 232.02 50 cm
Saft Ø 3 mm/Shaft Ø 3 mm

R 233.00 25 cm
Saft Ø 2 mm/Shaft Ø 2 mm

R 233.01 35 cm
R 233.02 50 cm
Saft Ø 3 mm/Shaft Ø 3 mm

R 234.02 50 cm
Saft Ø 3 mm/Shaft Ø 3 mm

R 235.02 50 cm
Saft Ø 3 mm/Shaft Ø 3 mm

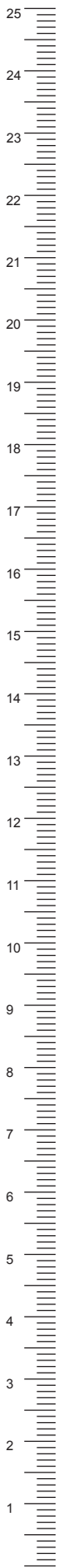

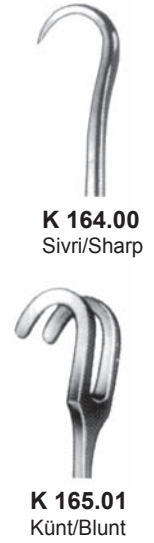
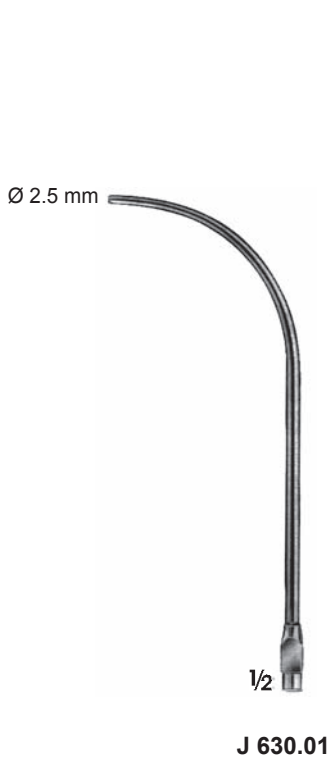



L 005.00
4.5 cm



L 005.01
5.5 cm



BOSE
L 009.00
6 cm



FINSEN
L 080.00
5 cm



FINSEN
L 081.00
7 cm



FINSEN
L 082.00
7.5 cm



FINSEN
L 083.00
7 cm

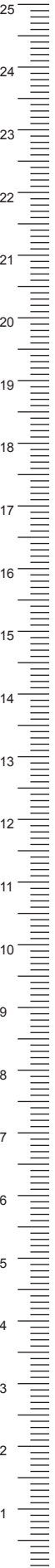



Oral, Yüz Cerrahi
Oral, Facial Surgery

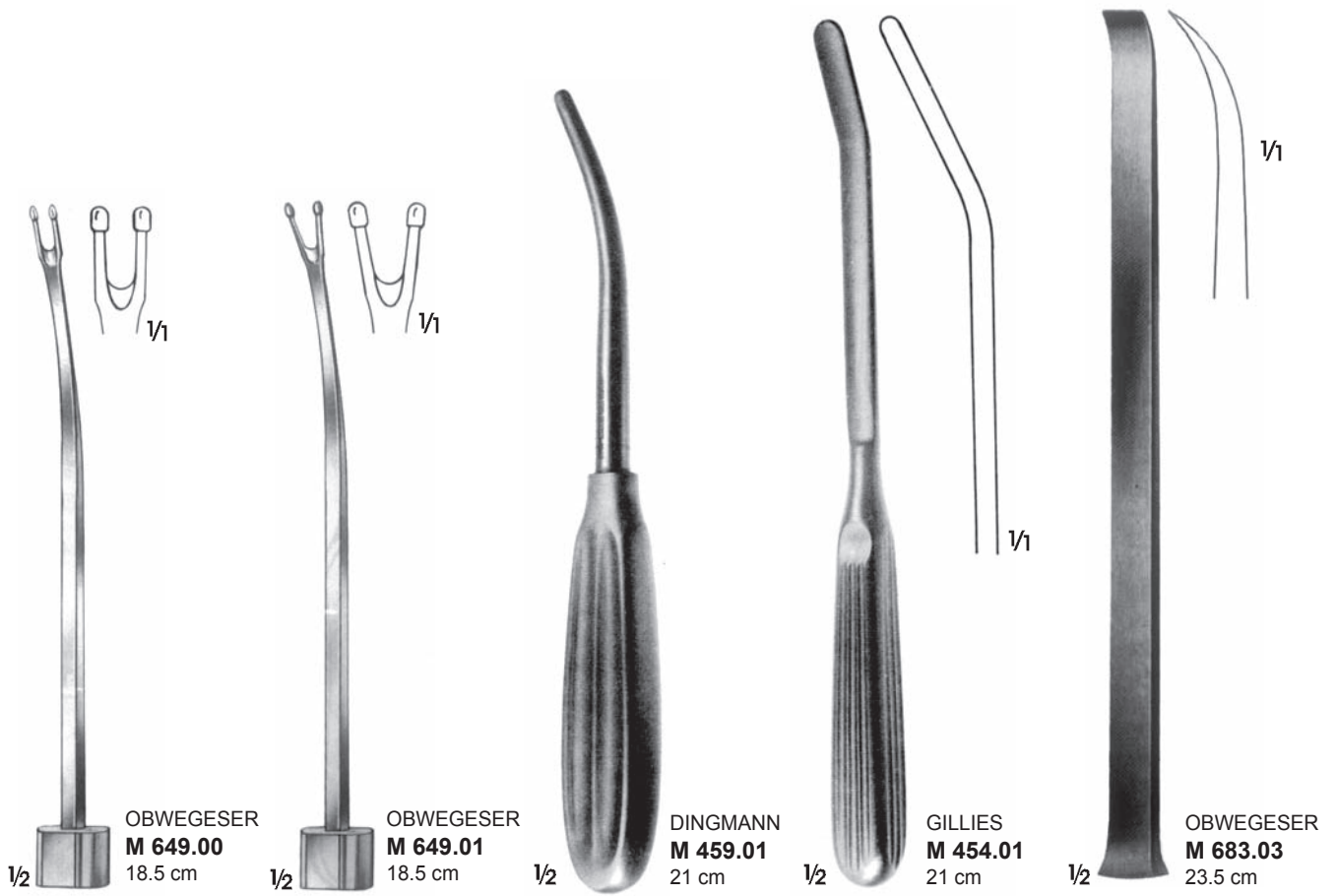

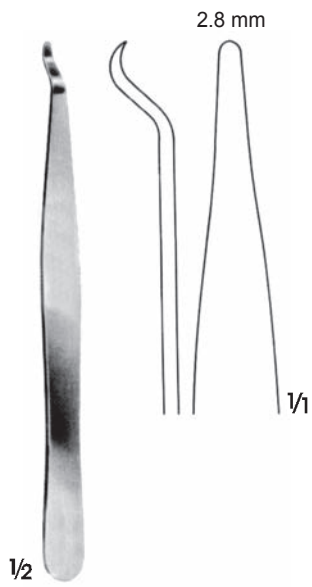

M 400.00
14 cm

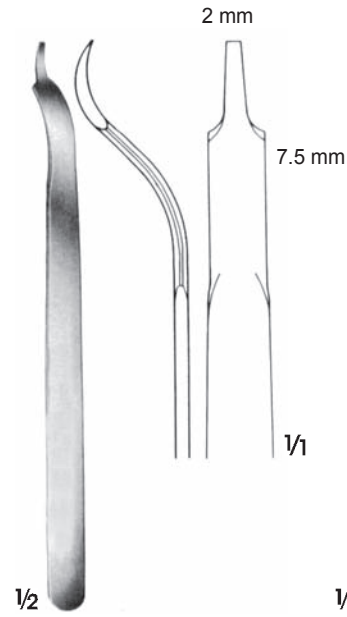

BUCK-GRAMCKO
M 401.00
15 cm

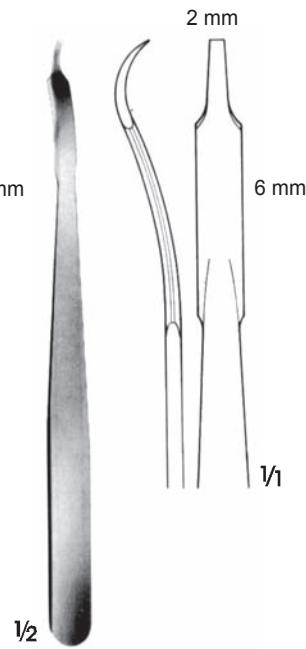

M 402.00
16 cm

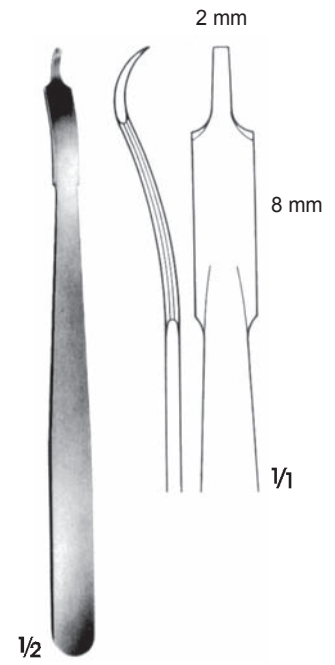

M 402.01
16 cm

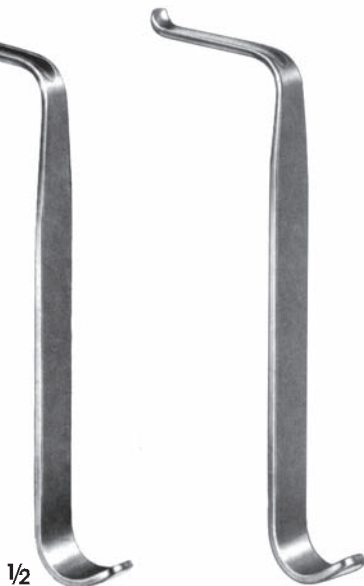
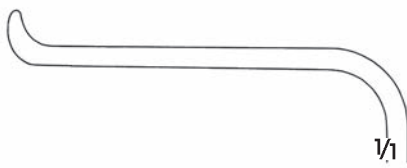

M 760.02
8.0 x 50 mm

M 760.01
6.5 x 50 mm



M 760.04
6.5 x 60 mm



M 760.03
6.5 x 50 mm

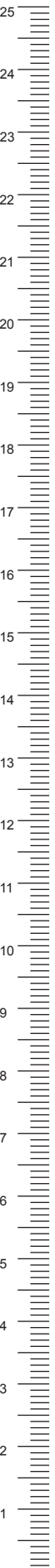

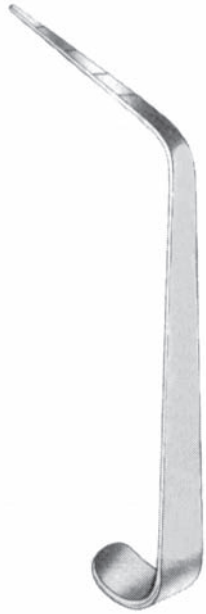

COTTLE
M 629.01 - M 629.04

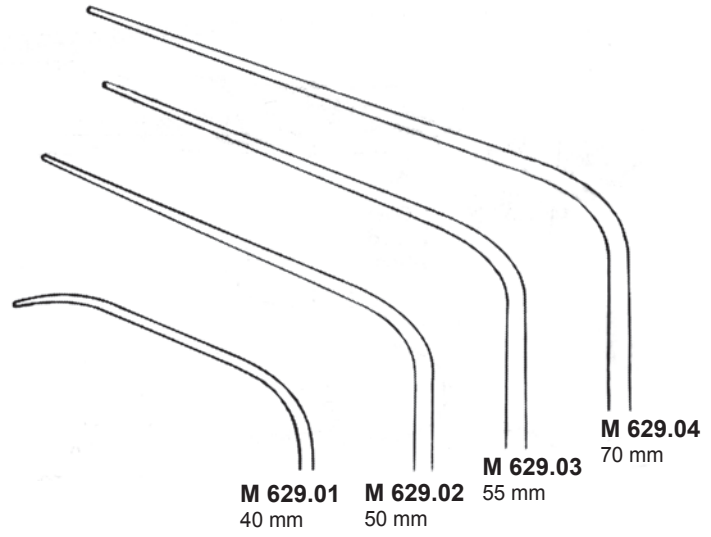

1/2
TESSIER
M 295.00
Sol/Left



1/2
TESSIER
M 295.01
Sağ/Right

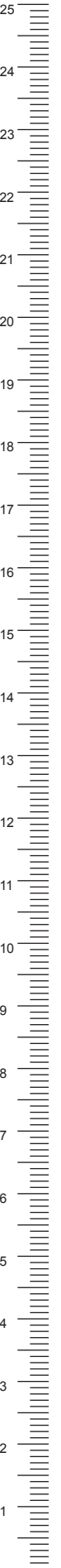
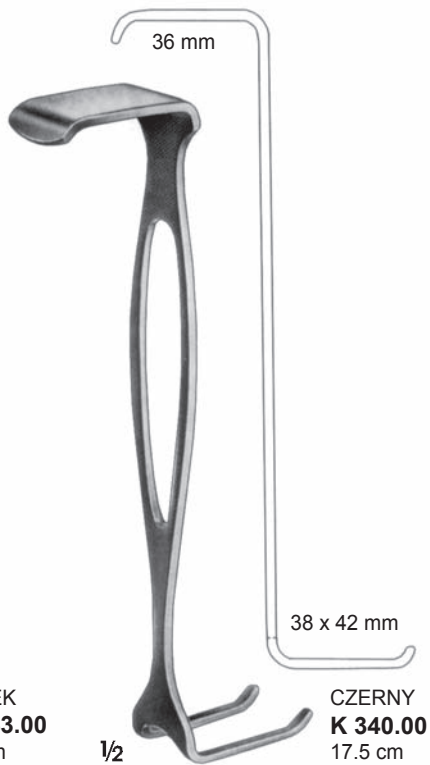
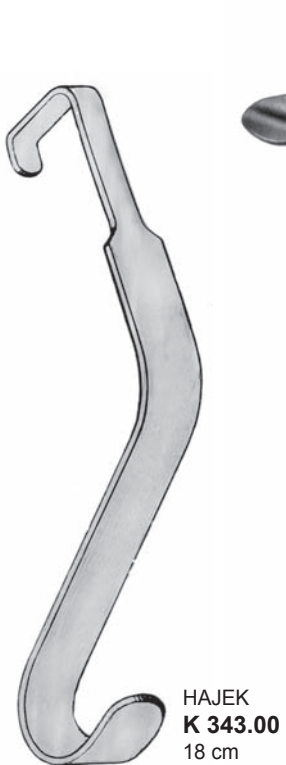
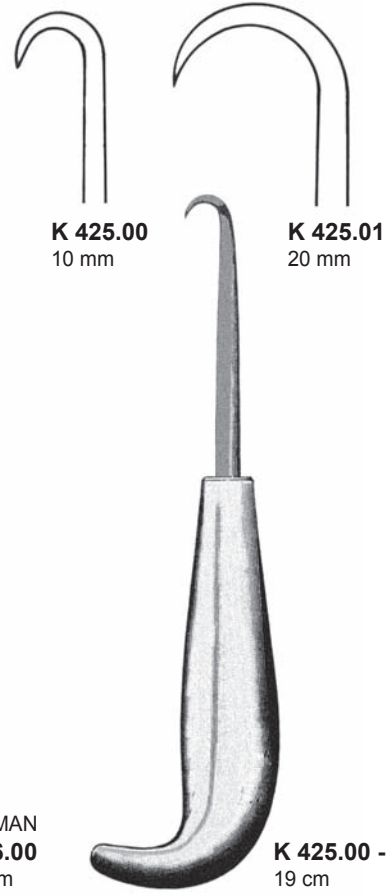
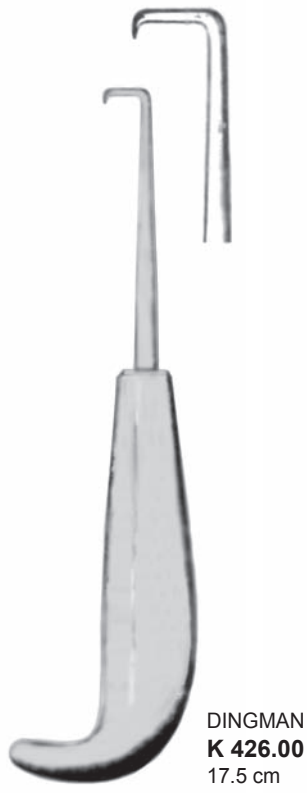



1/2

K 770.00
24 cm



1/2

K 771.00
Işık taşıyıcılı
With light carrier
27 cm

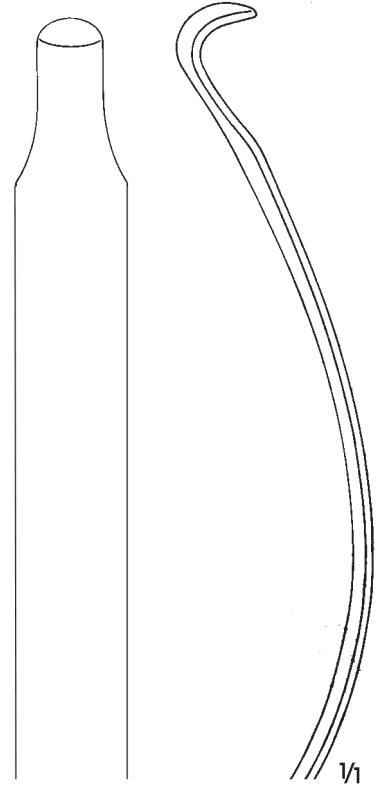

1/1

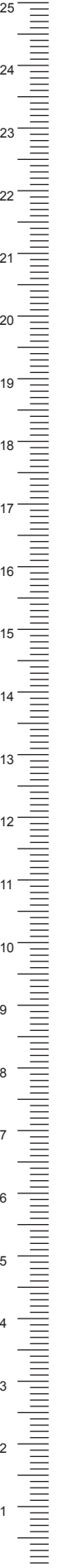
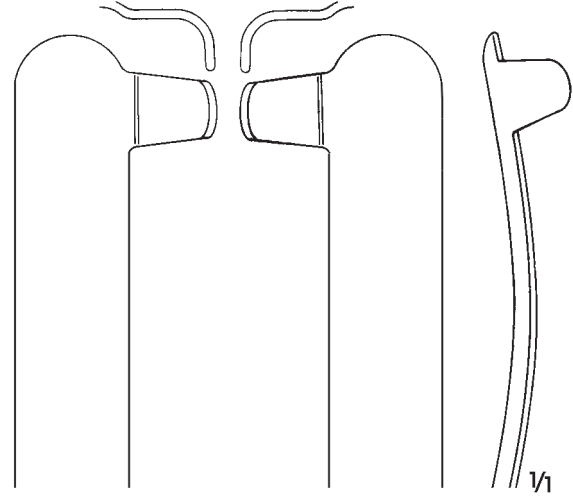

K 772.00
21 cm



K 772.01
21 cm



K 773.00
Işık taşıyıcılı
With light carrier
24 cm



K 773.01
Işık taşıyıcılı
With light carrier
24 cm



K 774.00
24 cm



K 775.00
Işık taşıyıcılı
With light carrier
27 cm

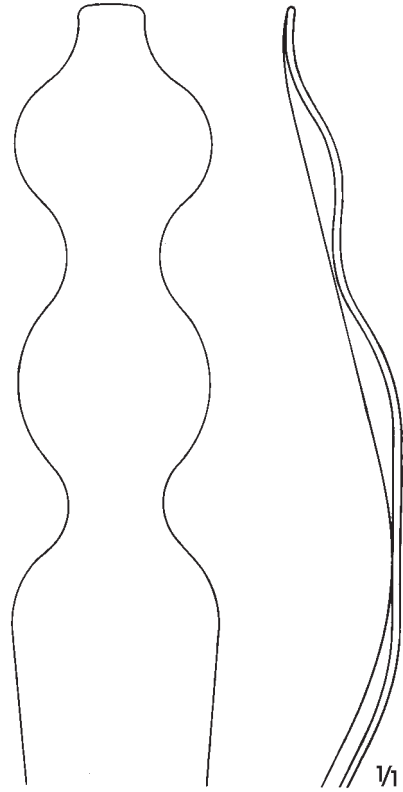

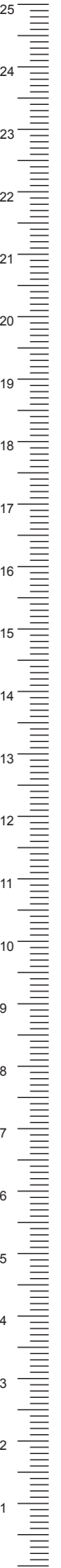

K 776.00
25 cm

1/2

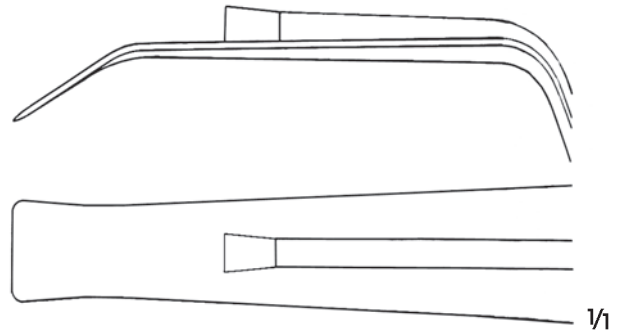

K 777.00
Işık taşıyıcılı
With light carrier
28 cm

1/2



K 778.00
Işık taşıyıcılı
With light carrier
24 cm



STENHAUSER
K 459.01 23.5 cm
Sağ/Right



STENHAUSER
K 459.02 23.5 cm
Sol/Left

STENHAUSER
K 459.00 23.5 cm
Komple/Complete



STEINHAUSER
K 603.01 24.5 cm
Sol/Left

STEINHAUSER
K 603.02 24.5 cm
Sağ/Right

STEINHAUSER
K 603.00 24.5 cm
Komple/Complete



GERY-LANE
K 462.00 10 x 85 mm
K 462.01 15 x 85 mm
27 cm

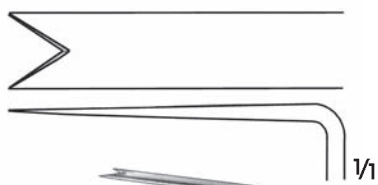

OBWEGESER
K 352.00 10 x 42 mm
22 cm

1/2



OBWEGESER
K 352.01 11 x 70 mm
22 cm

1/2

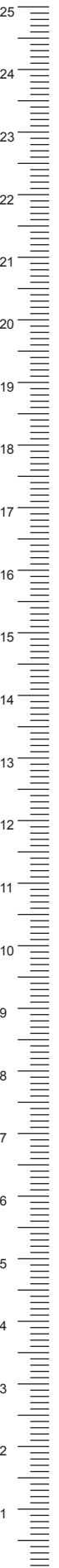



1/2

OBWEGESER
K 457.00 - K 457.05
21.5 cm

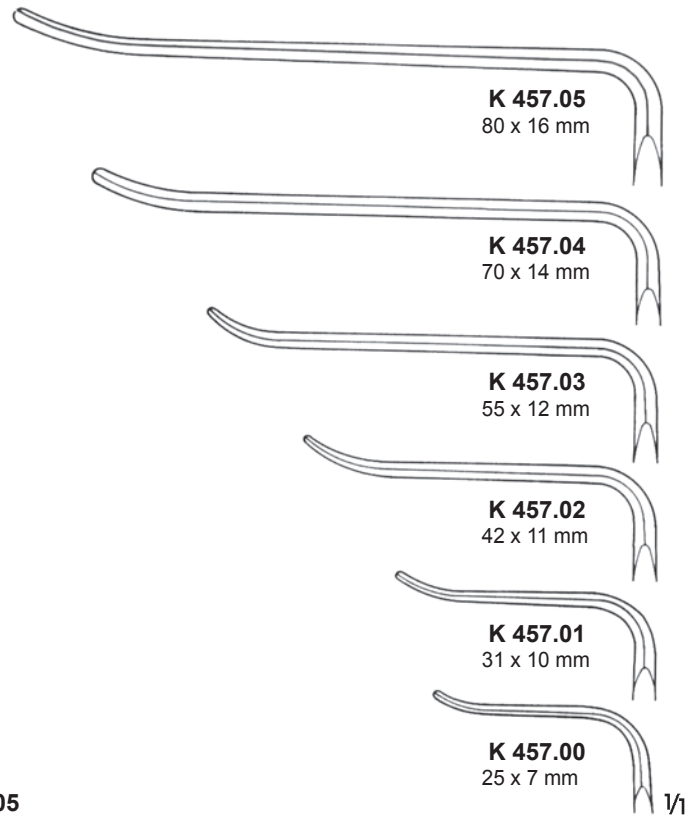

K 457.05
80 x 16 mm

K 457.04
70 x 14 mm

K 457.03
55 x 12 mm

K 457.02
42 x 11 mm

K 457.01
31 x 10 mm

K 457.00
25 x 7 mm

1/1



1/2

OBWEGESER
K 458.00 - K 458.05
21.5 cm

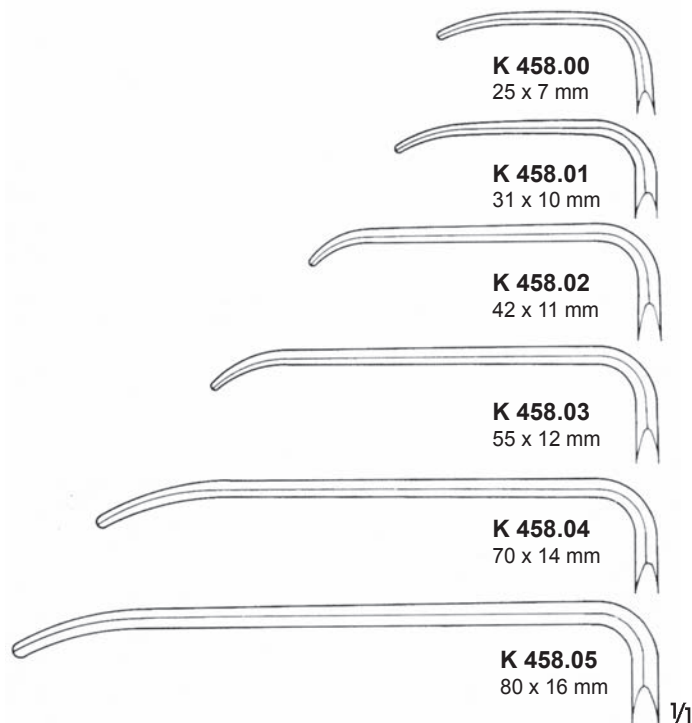

K 458.00
25 x 7 mm

K 458.01
31 x 10 mm

K 458.02
42 x 11 mm

K 458.03
55 x 12 mm

K 458.04
70 x 14 mm

K 458.05
80 x 16 mm

1/1

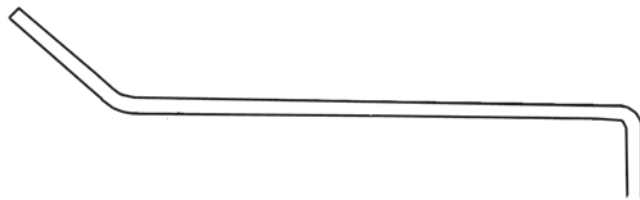
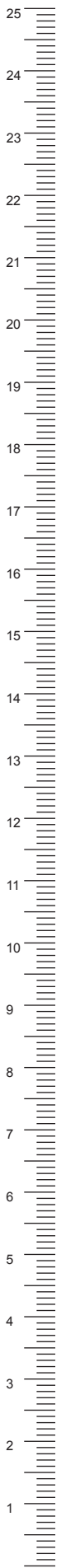

K 465.00
20 mm

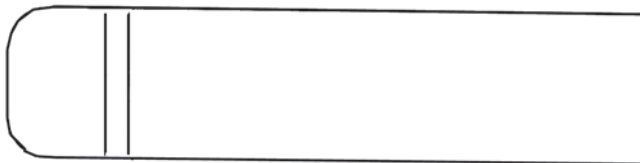

K 465.01
25 mm

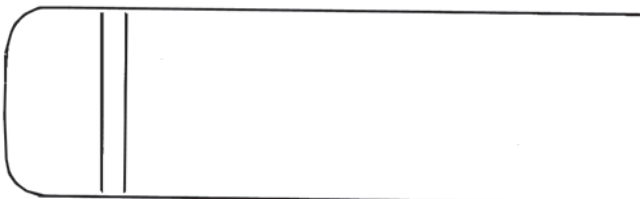

K 465.02
30 mm

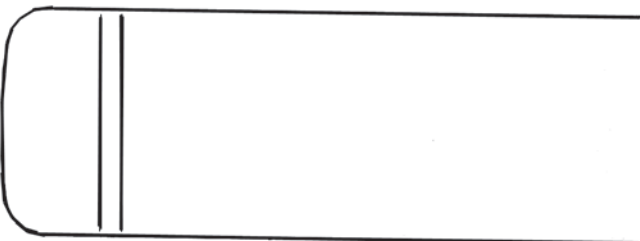

K 465.03
35 mm



1/2

K 465.00 - K 465.03
16 cm

1/1

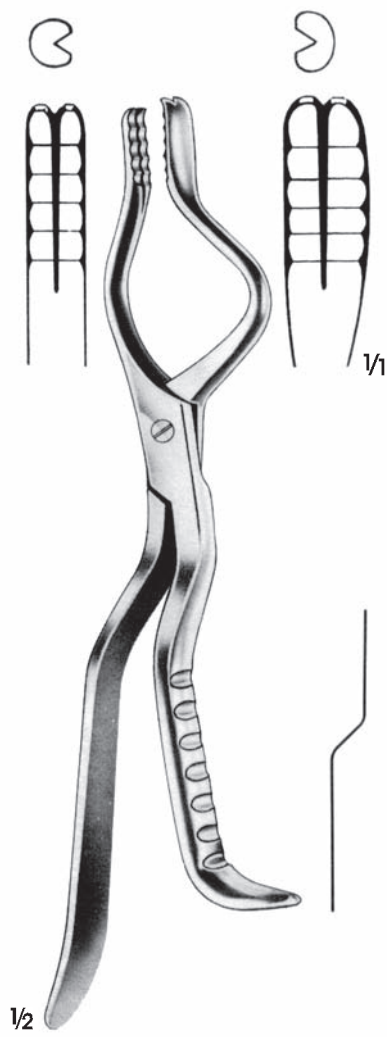

ROWE-DINGMAN
P 166.00 25 cm
Sol/Left

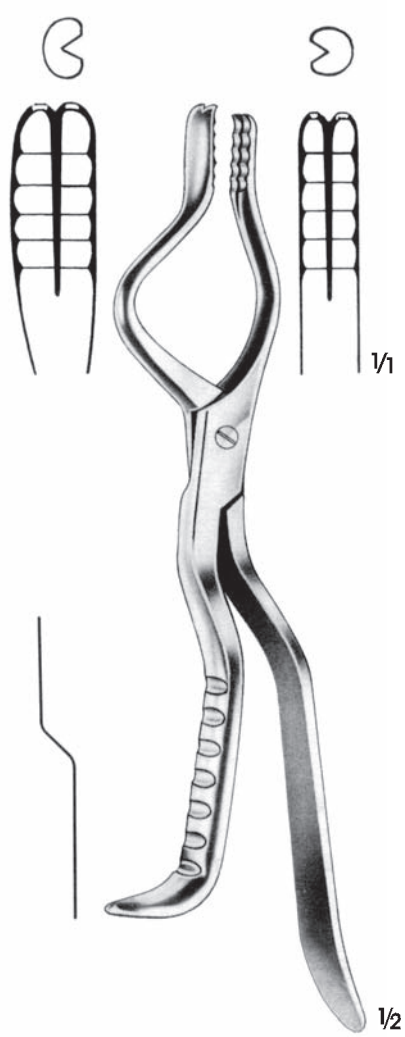

ROWE-DINGMAN
P 166.01 25 cm
Sağ/Right

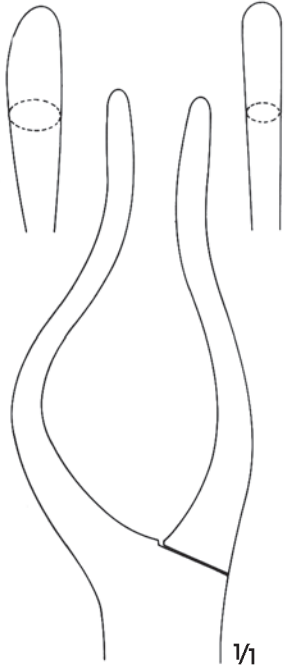

P 164.00 Sol/Left
P 165.00 Sağ/Right
Bebekler ve küçük çocuklar için
For babies and infants
21.5 cm

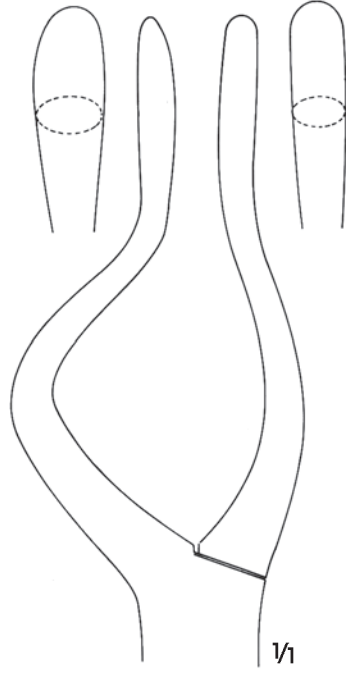

P 164.01 Sol/Left
P 165.01 Sağ/Right
Çocuklar ve gençler için
For children and adolescents
24 cm

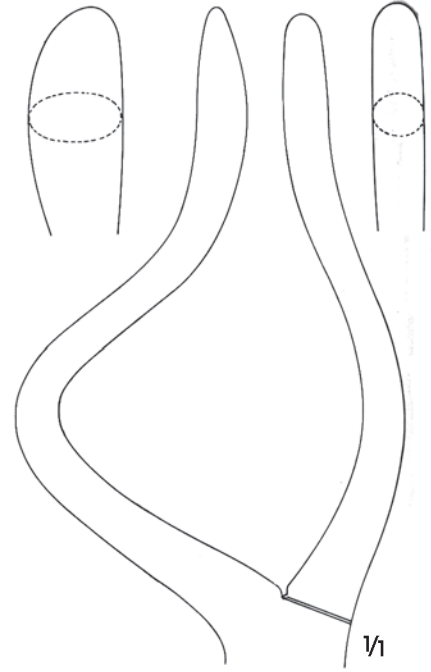

P 164.02 Sol/Left
P 165.02 Sağ/Right
Yetişkinler için
For adults
24.5 cm



ROWE
P 164.00 - P 164.02
Sol/Left



ROWE
P 165.00 - P 165.02
Sağ/Right





P 611.00
Çift ağız tırtıllı
Both jaws serrated
14 cm



P 617.00
Tek ağız tırtıllı
One jaw serrated
14 cm

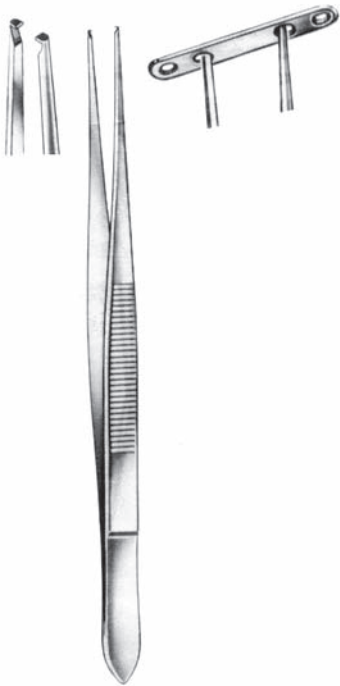

D 570.00
14 cm



D 571.00
14 cm



D 572.00
15 cm



LINDEMANN
V 611.00
4.5 cm



LINDEMANN
V 611.01
6.5 cm



LINDEMANN
V 611.02
8 cm



STEINHAUSER
V 646.00
12 cm



V 750.00
Ø 1.5 mm

9 mm



V 750.03
Ø 1.5 mm

17 mm



T 747.00
20 cm

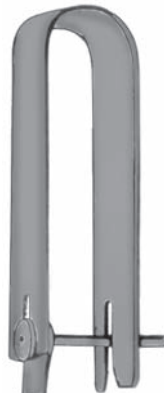

V 754.04
V 754.05 ve V 754.06 ile
kullanılır.
To be use with V754.05 and
V 754.06



V 754.00
Kılavuz/Guide
23 cm



V 754.05
2.5 mm



V 754.06
Pin





Genel Cerrahi
General Surgery



1/2
LUER-FRIEDMANN
P 265.00
14.5 cm



1/2
P 266.00
14 cm



1/2
LUER
P 268.00
15.5 cm



1/2
BLUMENTHAL
P 270.00
15.5 cm

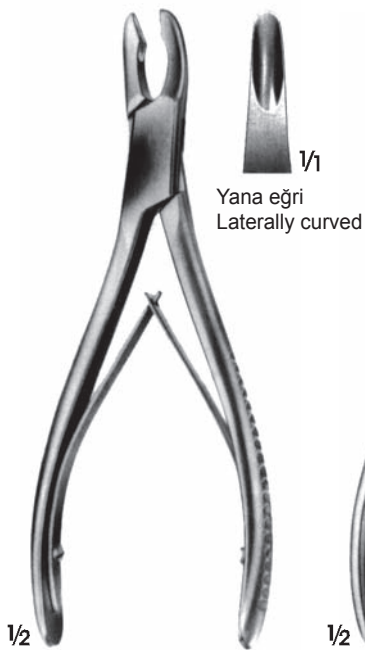

1/2
Yana eğri
Laterally curved
HAKANSSON
P 275.00
17 cm

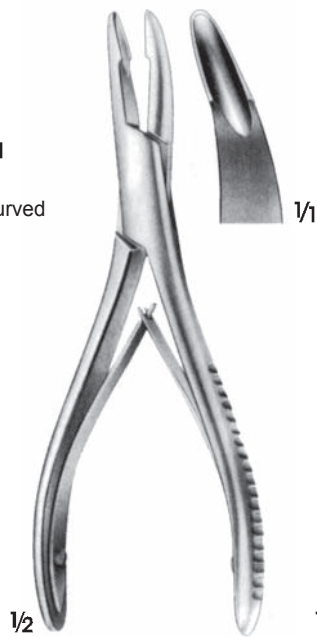

1/2
MEAD
P 276.00
16.5 cm



1/2
JANSEN
P 277.00
17.5 cm



1/2
JANSEN
P 278.00
17.5 cm



BANE-HARTMANN
P 279.00
17.5 cm



BEYER
P 285.00
18 cm



LEMPERT
P 286.00
20 cm



LEMPERT
P 287.00
20 cm

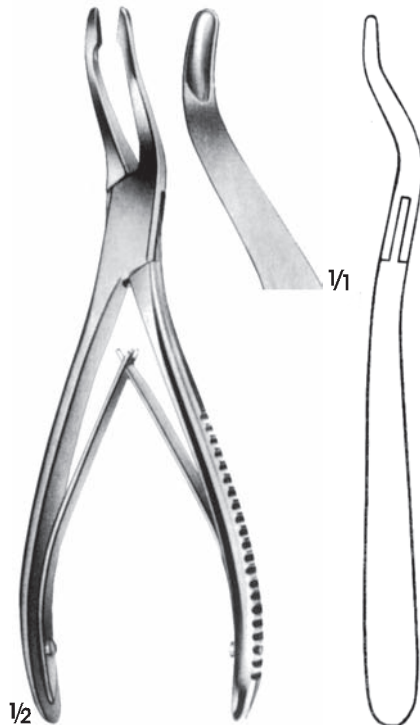

JANZEN
P 282.00
19 cm

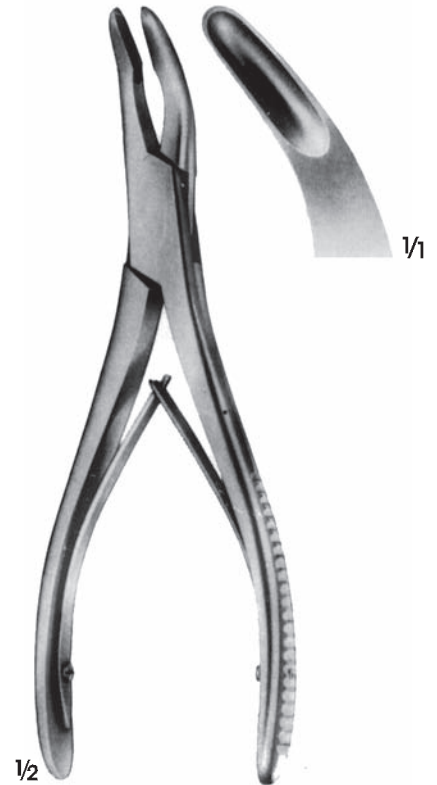

OLIVECRONA
P 297.00
20.5 cm

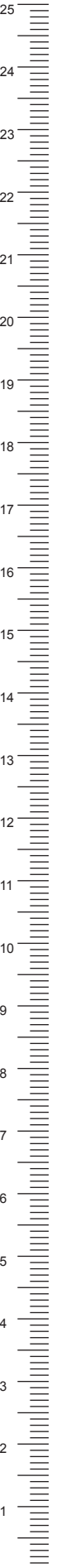

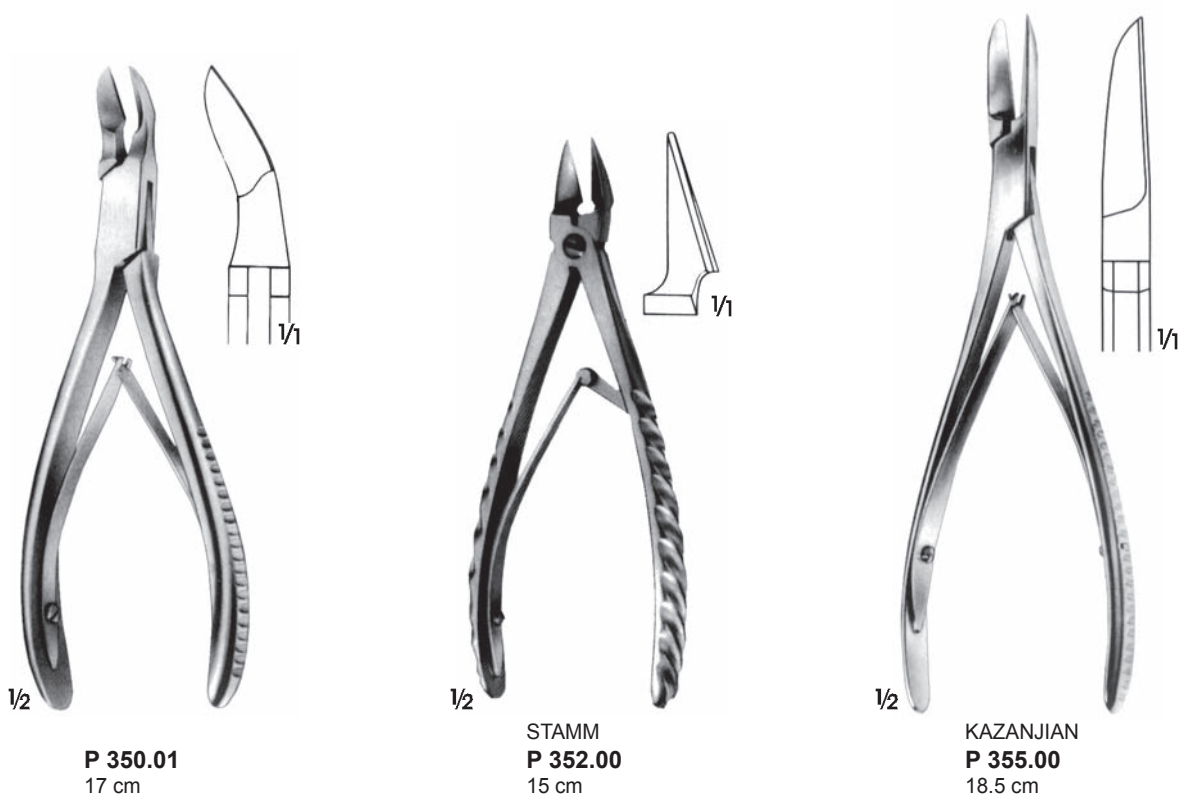
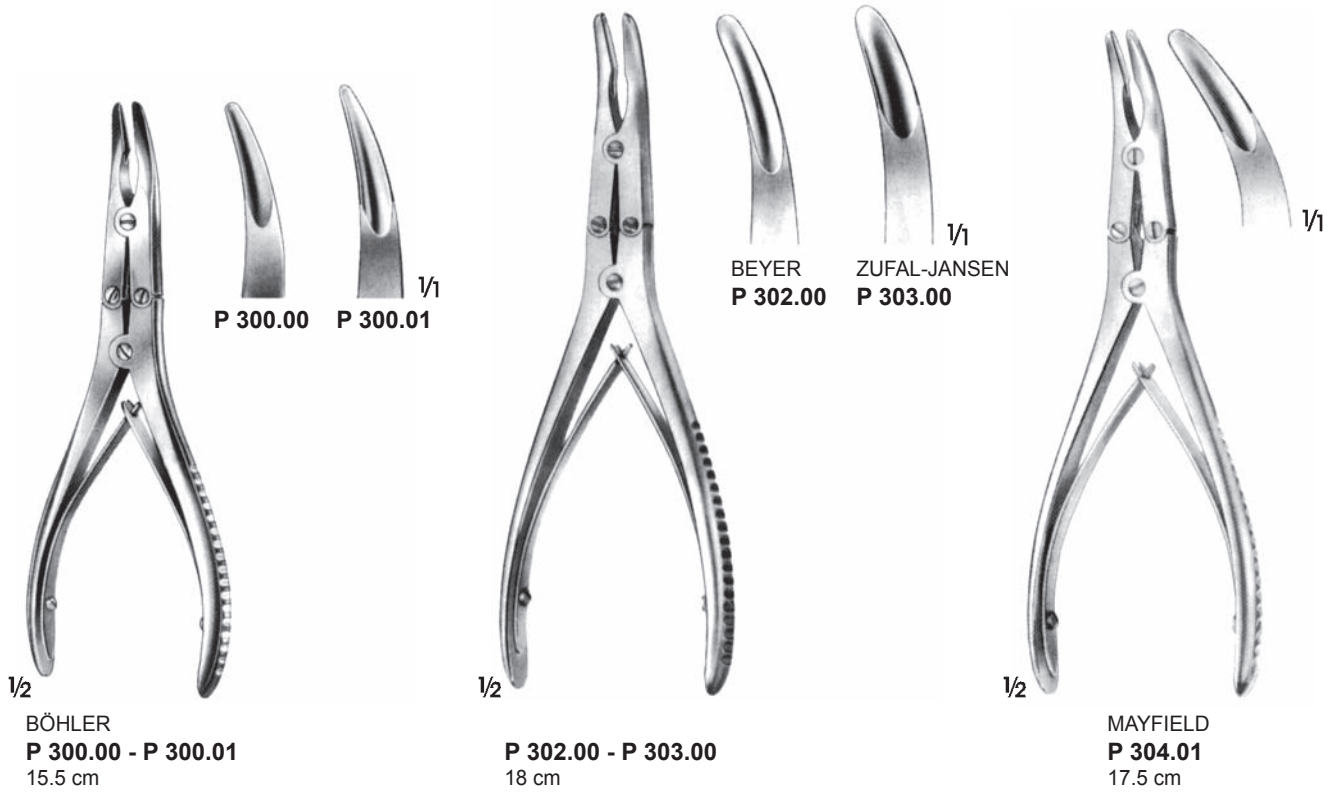

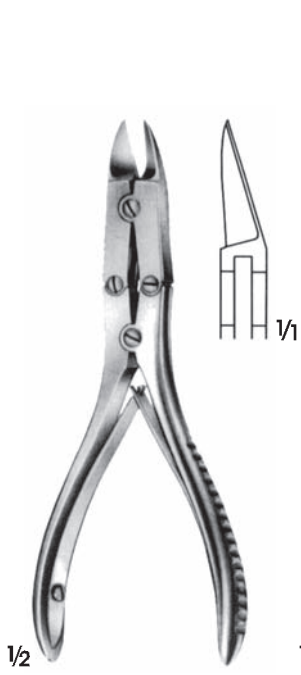
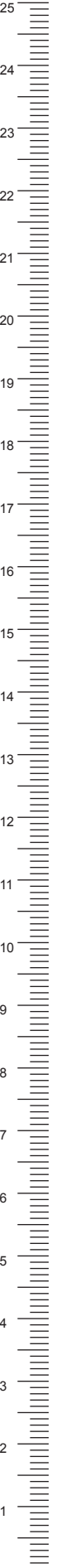

BÖHLER
P 366.00
14.5 cm

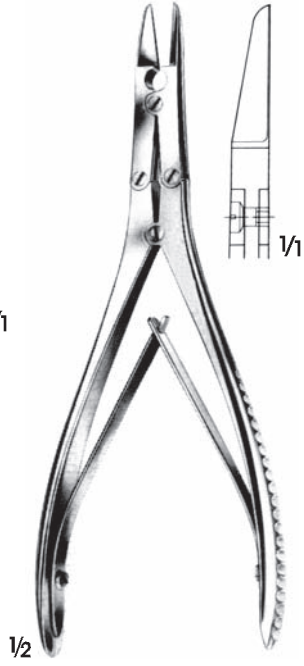

P 367.00
17 cm



MC INDOE
P 368.00
17.5 cm



GIERTZ-STILLE
P 502.01
25 cm



KILLIAN
C 695.00
Çift ağız tırtilli
Both jaws serrated
20 cm



MUHLING
C 695.01
21 cm

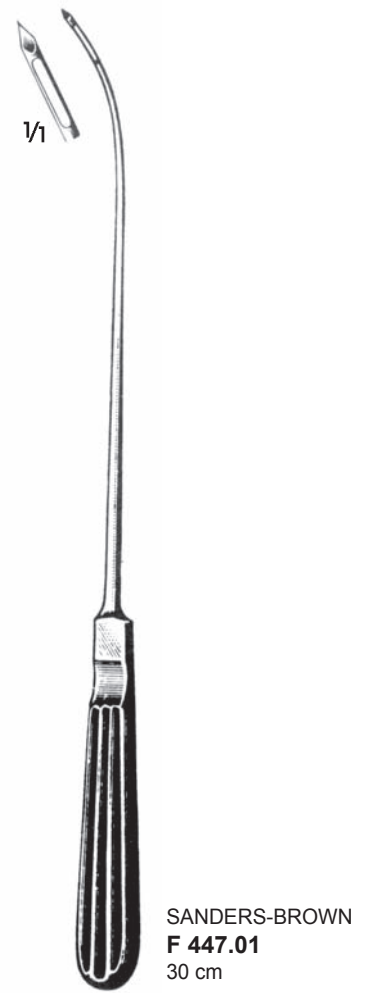
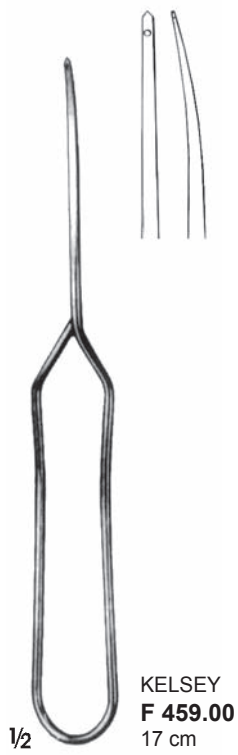

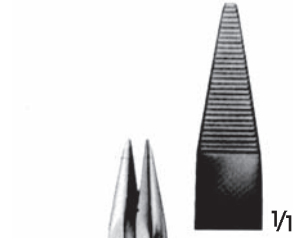
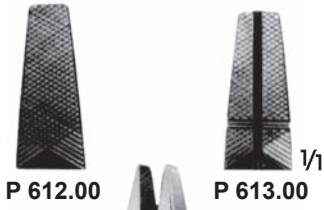
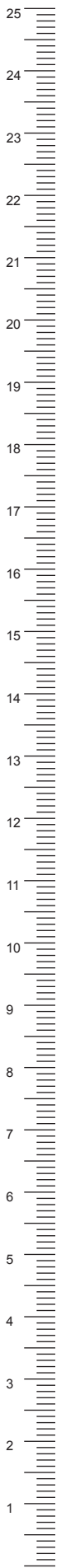

Elmas Kesici Ağız / With Carbide Cutting Edges

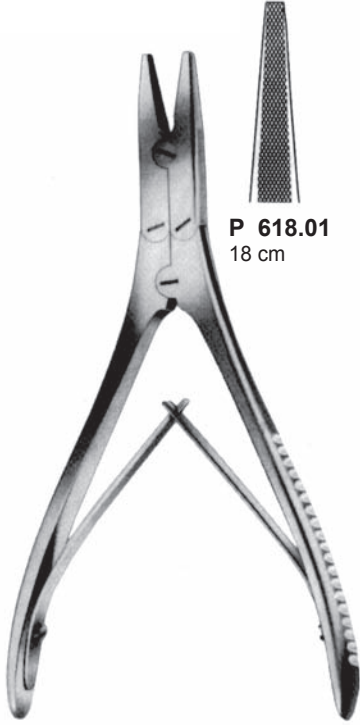

P 618.01
18 cm



P 618.05
14.5 cm



P 618.02
18 cm



P 618.03
18 cm

P 618.01 - P 618.05



1/2

REILL

P 640.00

Kemiğe Yakın Olan Telleri Kesme
For cutting off wires close to the bone
17.5 cm



1/1
Yumuşak tel için Ø 2.0 mm
For soft wire Ø 2.0 mm
Sert tel için Ø 1.5 mm
For hard wire Ø 1.5 mm

Elmas Kesici Ağız / With Carbide Cutting Edges

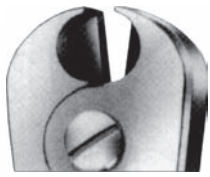
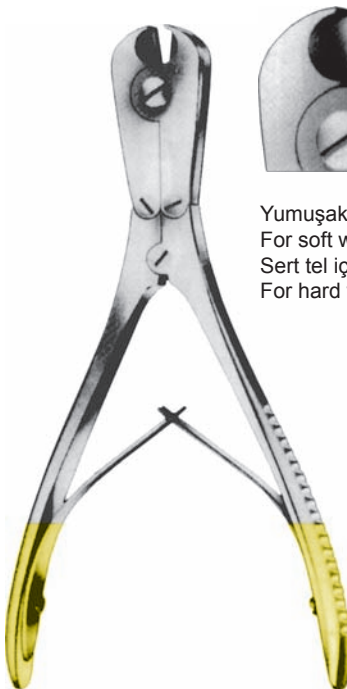

1/1

Yumuşak tel için Ø 2.0 mm
For soft wire Ø 2.0 mm
Sert tel için Ø 1.5 mm
For hard wire Ø 1.5 mm

P 641.00
Ön ve Yanal kesme
Front-and lateral cutting
18 cm

1/2
220



1/2

P 643.00
Yanal Kesme
Lateral Cutting
23.5 cm



1/1

Yumuşak tel için Ø 3.0 mm
For soft wire Ø 3.0 mm
Sert tel için Ø 2.2 mm
For hard wire Ø 2.2 mm

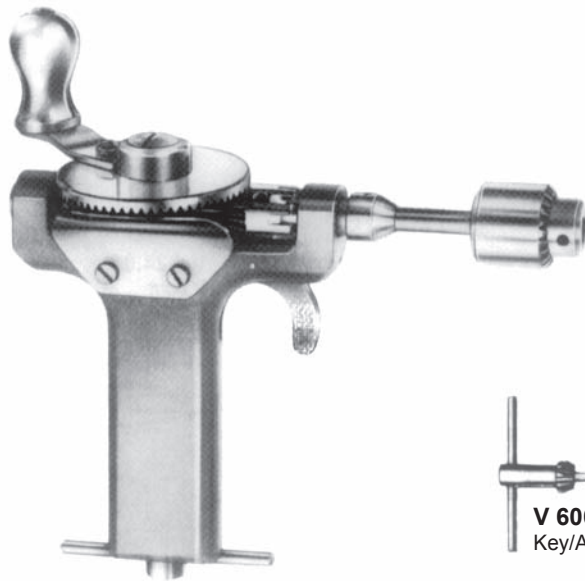
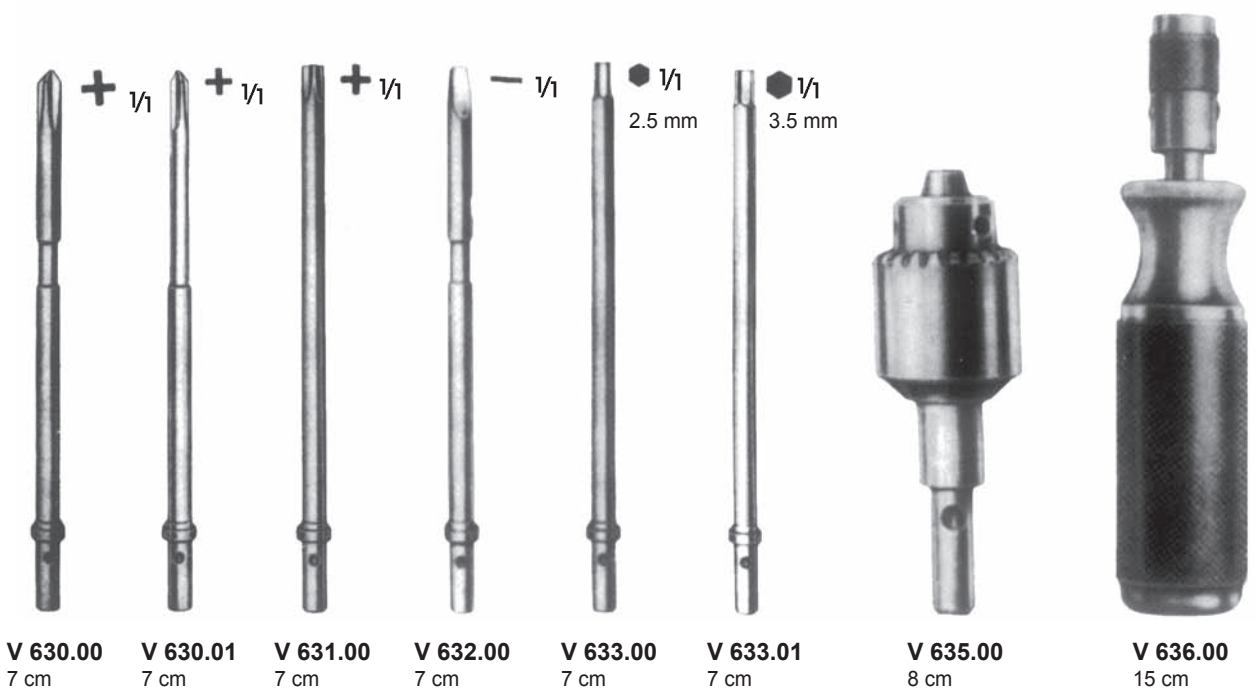

BUNNEL
V 615.00
 El matkabi/Hand drill only
 V 606.00 Anahtari ile/With key
 16 cm



V 608.00
 Delme başlığı Ø 4.5 mm
 Drilling chuck Ø 4.5 mm
 V 606.00 Anahtari ile/With key
 14 cm

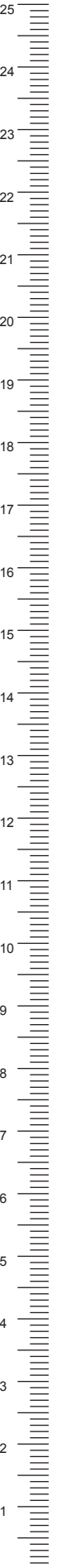



Z 120.00
11.5 cm

Izolesiz
Non-insulated



Z 121.00
12 cm

Izolesiz
Non-insulated



Z 100.00 0.3 mm
14 cm

Izolesiz
Non-insulated



Z 150.00 0.6 mm
Z 150.01 0.9 mm
16 cm

Izoleli
Insulated

Z 150.03 0.9 mm
20 cm



Z 151.01 0.9 mm
16 cm

Izoleli
Insulated

Z 151.03 0.9 mm
20 cm



Z 180.00 0.7 mm
16 cm

Izolesiz
Non-insulated

Z 180.01 1.0 mm
18.5 cm

Z 180.02 1.0 mm
20 cm

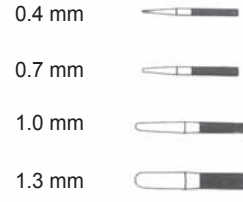

Izolesiz
Non-insulated

Z 170.01 0.9 mm
16 cm

Z 170.04 0.9 mm
18.5 cm

Z 170.07 0.9 mm
20 cm



Izoleli
Insulated

Z 171.01 0.9 mm
16 cm
Izolesiz/Non-insulated

Z 172.01 0.9 mm
18.5 cm
Izoleli/Insulated



Izoleli
Insulated

Z 160.08 0.4 mm
Z 160.09 0.7 mm
Z 160.10 1.0 mm
Z 160.11 1.3 mm
17.5 cm

Z 160.12 0.4 mm
Z 160.13 0.7 mm
Z 160.14 1.0 mm
Z 160.15 1.3 mm
19.5 cm

Z 160.16 0.4 mm
Z 160.17 0.7 mm
Z 160.18 1.0 mm
Z 160.19 1.3 mm
21.5 cm

Z 160.20 0.4 mm
Z 160.21 0.7 mm
Z 160.22 1.0 mm
Z 160.23 1.3 mm
23.5 cm



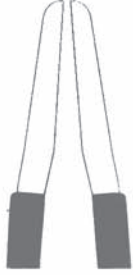

Z 188.00 1.0 mm
21.5 cm
Izolesiz/Non-insulated

Z 190.00 1.0 mm
21.5 cm
Izoleli/Insulated



Z 001.00
Oval kesme elektrodu
Cutting electrode
Boy/Length 30 mm
En/Wide 3.5 mm



Z 002.00
Açılı kesme elektrodu
Angled cutting electrode
Boy/Length 14 mm
En/Wide 1.8 mm



Z 003.00
Kesme elektrodu, hassas
Cutting electrode, delicate
25 mm



Z 004.00
Bıçak elektrod
Knife electrode
25 mm



Z 005.00
Bıçak elektrod
Knife electrode
18 mm



Z 010.00
Plaka elektrod
Plate electrode



Z 006.00
Halkali elektrodu
Loop electrode
Ø 10 mm
Tel Ø 3 mm/Wire Ø 3 mm



Z 009.00
Halkali elektrodu
Loop electrode
Ø 15 mm



Z 012.00
Açılı Halkali elektrodu
Angled Loop electrode
Ø 8 mm



Z 015.00 Ø 2.5 mm
Z 015.01 Ø 4 mm
Z 015.02 Ø 6 mm
Küresel uçlu elektrodu
Ball point electrode



Z 016.00 Ø 0.3 mm
Z 016.01 Ø 0.5 mm
Z 016.02 Ø 0.7 mm
İğne elektrodu
Needle electrode
25 cm



Z 095.00 Komple/Complete
Cerrahi elektrod lar - Surgical electrodes
Ø 4 mm

12 elektrod luk ray
Rack for 12 surgical electrodes

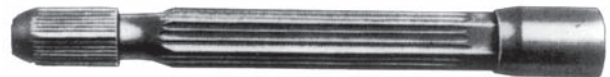

Z 060.00
Elektrod tutucusu
Electrode holder



Z 096.00
Kapakli elektrod konteyneri
Container with lid for electrodes
25 cm

Z 097.00 Komple/Complete
Z 095.00 - Z 096.00

Z 065.00
Bipolar kordon
Bipolar cord
2 mt.

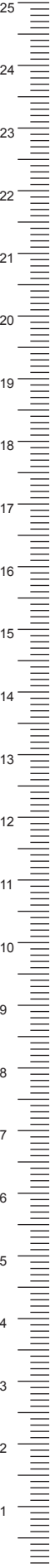



Setler
Sets



1



2



3



4



5



6



7



8



9



10



11



12

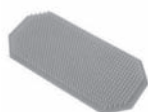

13

No	Quantity	Code	Description
1	1	A 252.01	Toynbee Ear Speculum, 4.0 mm
2	1	A 252.02	Toynbee Ear Speculum, 5.5 mm
3	1	A 252.03	Toynbee Ear Speculum, 7.0 mm
4	1	B 220.00	Politzer Knife, 16 cm
5	1	J 236.00	Suction Canulla, Handle, Luer Cone
6	1	J 236.02	Suction Canulla, Luer Cone, 0.7 mm
7	1	J 236.03	Suction Canulla, Luer Cone, 1.0 mm
8	1	J 236.04	Suction Canulla, Luer Cone, 2.0 mm
9	1	K 057.02	Shea Hook, 17.5 cm
10	1	N 354.02	Buck Ear Curette, Curved, 2.5 mm, 15 cm
11	1	R 227.00	Hartman-Wullstein Ear Forceps 8 cm
12	1	Y 410.04	Mini Container 300 X 140 X 40 mm
13	1	Y 850.00	Silicon Mat 270 X 125 mm

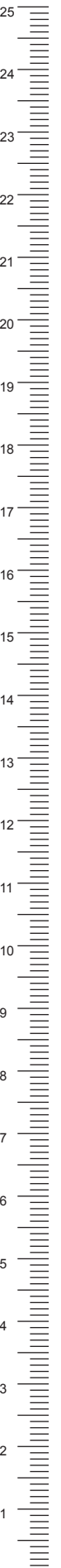

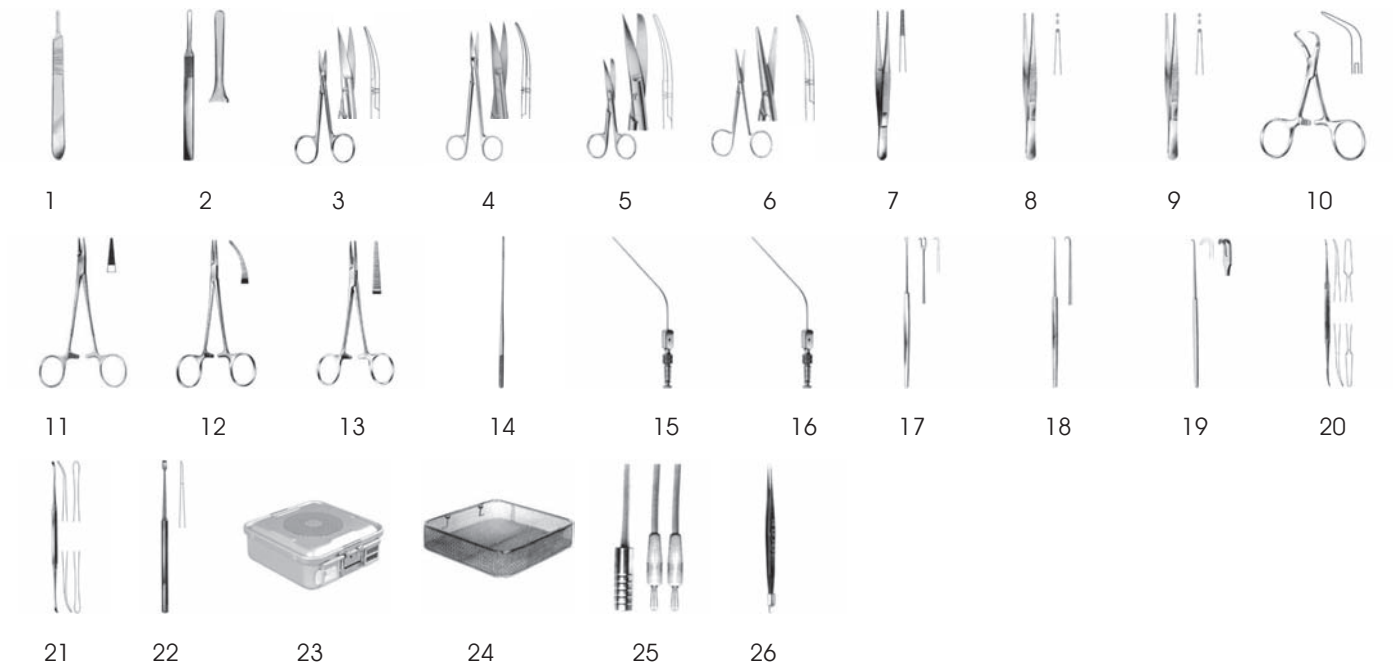

No	Quantity	Code	Description
1	1	B 030.01	Scalpel Handle, No3, 13.5 cm
2	1	B 231.00	Cottle Knife, Round 14 cm
3	1	C 231.00	Scissors Delicate, Curved, 11 cm
4	1	C 251.00	Joseph Scissors, Curved, 14 cm
5	1	C 311.03	Scissors, Curved, 14.5 cm
6	1	C 411.00	CottleKnapp Scissors, Curved, 10.5 cm
7	1	D 218.01	Dissecting Forcep, 15 cm
8	1	D 361.00	Tissue Forcep, Delicate, 11.5 cm
9	1	D 361.02	Tissue Forcep, Delicate, 14.5 cm
10	6	E 430.01	Backhaus Towel Clamp, 11 cm
11	1	F 328.00	Baby-Crille-Wood Needle Holder, 15 cm
12	6	G 207.00	Micro-Halsted Forcep, Curved, 12.5 cm
13	1	G 220.00	Baby-Crille Forcep, Straight, 14 cm
14	1	J 056.01	Lathbury-Farrel Triangular Serrated, 14 cm
15	1	J 214.00	Fergusson Suction Tube, With Luer Hub, Ø 2.0 mm, 18 cm
16	1	J 214.01	Fergusson Suction Tube, With Luer Hub, Ø 2.5 mm, 18 cm
17	1	K 128.00	Freer Hook, 15 cm
18	1	K 134.00	Cottle Hook, 16 cm
19	1	K 169.01	Retractor, 2 Prongs, Blunt, 16.5 cm
20	1	M 160.01	Killian Elevator, 18.5 cm
21	1	M 161.01	Freer Elevator, 18.5 cm
22	1	M 605.00	Freer Elevator, 16 cm
23	1	Y 310.10	1/2 Size Container, 285 x 280 x 100 mm
24	1	Y 390.07	Wire Baskets, 255 x 245 x 70 mm
25	1	Z 065.00	Bipolar Cord, 2 mt.
26	1	Z 150.01	Bipolar Forceps, Insulated, 16 cm

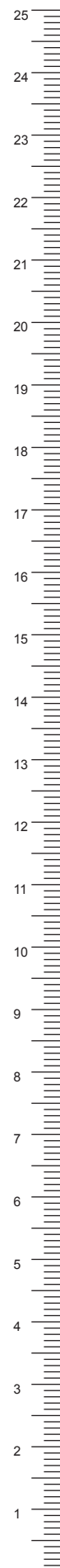



1 2 3 4 5 6 7 8 9 10



11 12 13 14 15 16 17 18 19 20

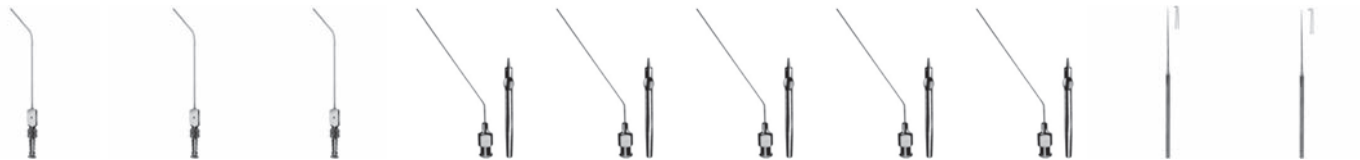

21 22 23 24 25 26 27 28 29 30



31 32 33 34 35 36 37 38 39 40



41 42 43 44 45 46 47 48 49 50



51 52 53 54 55 56 57 58 59



60 61 62 63 64

No	Qty	Code	Description	No	Qty	Code	Description
1	1	A 252.01	Tynbe Ear Speculum, Ø 4.0 mm	61	2	Y 390.05	Wire Baskets, 255 x 245 x 50 mm
2	1	A 252.02	Tynbe Ear Speculum, Ø 5.5 mm	62	1	Y 851.00	Silicon Mat, 245 x 245 mm
3	1	A 252.03	Tynbe Ear Speculum, Ø 7.0 mm	63	1	Z 065.00	Bipolar Cord, 2 mt.
4	2	B 030.01	Scalpel Handle, 3 No, 13.5 cm	64	1	Z 172.01	Bipolar Forceps, insulated, 18.5 cm
5	1	B 080.34	Ronis Ear Knife 15 cm				
6	2	B 080.42	Ear Knife, 16 cm				
7	2	B 080.46	Plester Ear Knife, 16 cm				
8	2	B 080.50	Ear Knife, 16 cm				
9	1	C 080.16	Shea Ear Scissors, 8 cm				
10	1	C 080.17	Richards Ear Scissors, 8 cm				
11	1	C 311.02	Surgical Scissors, Curved, 13 cm				
12	1	C 311.03	Surgical Scissors, Curved, 14.5 cm				
13	1	C 668.00	Wire Scissors, Serrated, 12 cm				
14	1	D 218.01	Semken Forcep, 15 cm				
15	1	D 361.01	Tissue Forcep 13 cm				
16	6	E 430.00	Backhaus Towel Clamp, 9 cm				
17	1	F 325.00	Halsey Needle Holder, 13 cm				
18	1	G 206.00	Micro-Halsted Haemostatic Forceps, Straight, 12.5 cm				
19	2	G 207.00	Micro-Halsted Haemostatic Forceps, Curved, 12.5 cm				
20	1	G 240.00	Crille Haemostatic Forceps, Straight, 14 cm				
21	1	J 212.00	Plester Suction Tube, With Luer Hub, Ø 1.5 mm, 19.5 cm				
22	1	J 212.01	Plester Suction Tube, With Luer Hub, Ø 2.0 mm, 19.5 cm				
23	1	J 212.02	Plester Suction Tube, With Luer Hub, Ø 2.5 mm, 19.5 cm				
24	1	J 236.00	Suction Tube, Handle				
25	4	J 236.01	Suction Tube, With Luer Cone, Ø 0.5 mm				
26	4	J 236.02	Suction Tube, With Luer Cone, Ø 0.7 mm				
27	4	J 236.03	Suction Tube, With Luer Cone, Ø 1.0 mm				
28	4	J 236.04	Suction Tube, With Luer Cone, Ø 1.3 mm				
29	1	K 050.03	Austin Ear Pick 16.5 cm, 0.3 mm				
30	1	K 050.05	Austin Ear Pick, 0.7 mm, 16.5 cm				
31	1	K 050.09	Ronis Ear Pick, 0.8 mm, 15 cm				
32	1	K 050.10	Scheer Ear Pick, 1.0 mm, 16 cm				
33	1	K 050.19	Ronis Ear Pick, 45°, 15 cm				
34	1	K 050.24	Scheer Ear Pick, 0.6 mm 16 cm				
35	1	K 050.26	Goldman Ear Pick 15 cm				
36	1	K 050.28	Austin Ear Pick, 16.5 cm				
37	1	K 057.01	Shea Ear Hook 45° 17.5 cm				
38	2	K 057.07	House Type Ear Hook 16.5 cm				
39	2	K 057.09	Scheer Ear Hook 16 cm				
40	1	K 058.08	Schuknecht Ear Hook, 90°, 15.5 cm				
41	1	K 238.00	Williger Retractor, sharp, 12 cm				
42	1	L 266.01	Hartman-Halle Speculum 15.5 cm				
43	1	L 335.00	Plester Self-Retaining Retractor, Blunt Left, 11 cm				
44	1	L 336.00	Plester Self-Retaining Retractor, Blunt Right, 11 cm				
45	2	L 339.00	Plester Self-Retaining Retractor, Blunt, 13 cm				
46	2	M 150.01	Halle Elevator, Blunt, 3.3 mm 18 cm				
47	1	M 071.01	Schuknecht Ear Spatula 15.5 cm				
48	1	M 216.00	Williger Raspatory 6 mm, 16 cm				
49	2	N 056.01	Richards Ear Curette 18 cm				
50	2	N 056.03	House-Type Ear Curette 16 cm				
51	1	N 353.01	Buck Ear Hook 2.0 mm 15 cm				
52	1	N 353.02	Buck Ear Hook 2.5 mm 15 cm				
53	1	R 224.00	Hartmann-Wullstein Forcep, Ø 1 mm				
54	1	R 224.01	Hartmann-Wullstein Forcep, Ø 2 mm				
55	1	R 227.00	Hartmann-Wullstein Forcep, 0.8x6 mm				
56	1	P 050.02	Malleus Ear Forcep, 7 cm				
57	1	P 051.01	McGee Ear Forcep, 7 cm				
58	1	T 202.00	Schuknecht Vein Press				
59	1	V 051.05	Ear Perforator, 1 mm, 16 cm				
60	1	Y 310.13	1/2 Size Container 285x280x135 mm				

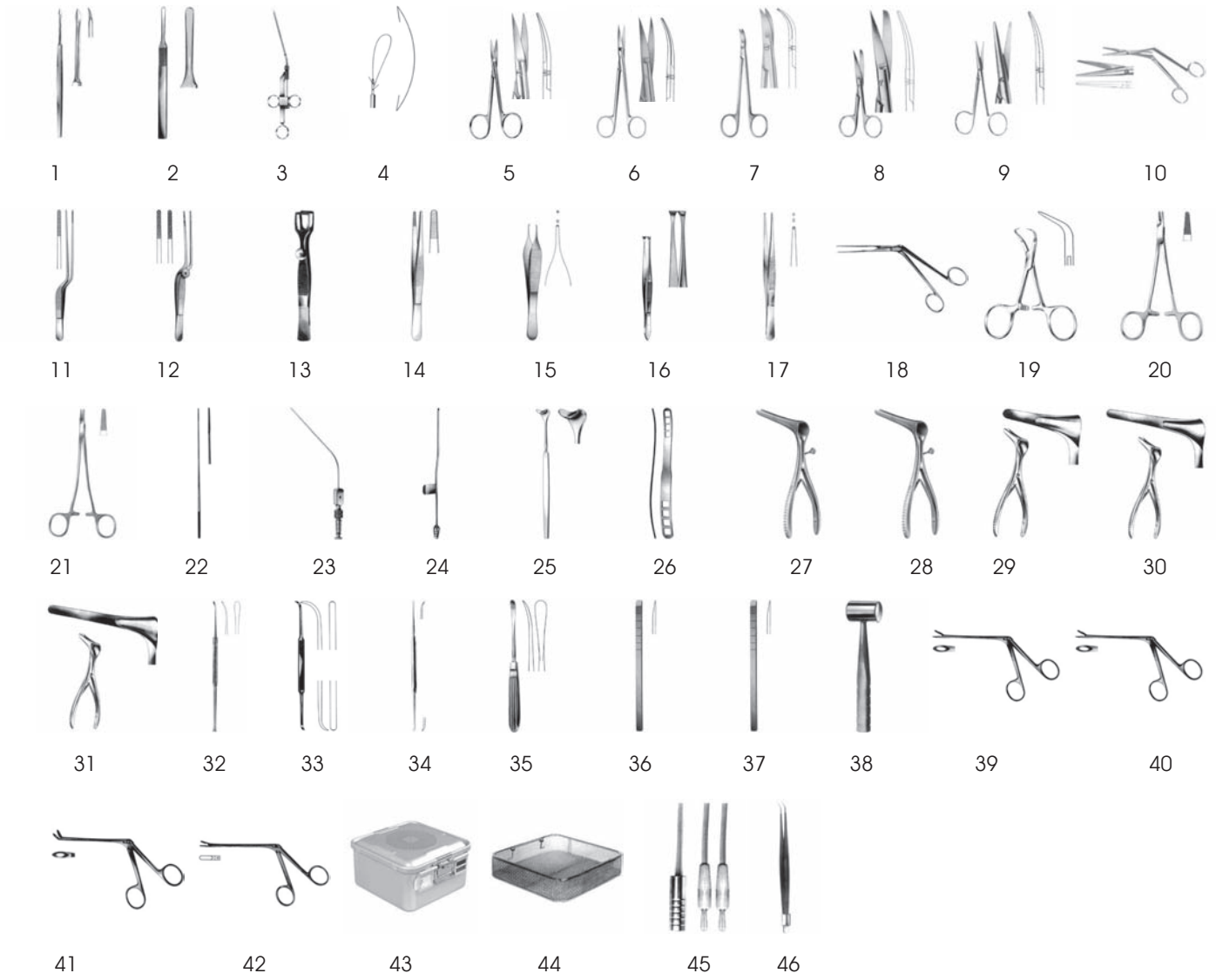

No	Quantity	Code	Description
1	1	B 130.00	Masing Nasal Knife 13 cm
2	1	B 231.00	Cottle Knife, 14 cm
3	1	B 557.00	Krause Polypus Snare, 25 cm
4	1	B 583.00	Snare Wire, Package of 12 pcs
5	1	C 231.00	Delicate Scissors, Curved 11 cm
6	1	C 251.00	Joseph Delicate Scissors, Curved 15 cm
7	1	C 260.00	Chadwick Scissors, 11.5 cm
8	1	C 311.03	Scissors, Curved, 14.5 cm
9	1	C 411.00	Cottle-Knapp Scissors, Curved 10.5 cm
10	1	C 560.00	Heymann-Knight Nasal Scissors, 17.5 cm
11	1	D 148.00	Jansen Forcep, Bayonet-Shaped 16 cm
12	1	D 150.00	Cottle Forcep, Bayonet-Shaped 14 cm
13	1	D 151.01	Cottle Columella Clamp, 10 cm
14	1	D 240.00	Standart Forcep, 11.5 cm
15	1	D 323.00	Adson Tissue Forcep, 12 cm
16	1	D 351.00	Graefe Tissue Forcep, 11 cm
17	1	D 361.00	Tissue Forcep, 11.5 cm
18	1	E 285.00	Lubet-Barbon Dressing Forcep 20 cm
19	6	E 430.01	Backhaus Towel Clamp, 11 cm
20	1	F 333.00	Crile-Wood Needle Holder, 14.5 cm
21	1	F 338.00	Sarot Needle Holder, 17.5 cm
22	2	J 056.02	Lathbury-Farrel Cotton Applicator, Triangular Serrated, 16 cm
23	1	J 214.02	Fergusson Suction Tube, With Luer Hub, Ø 3.0 mm, 18 cm
24	1	J 360.00	Canulla, Sharp, 4 mm, 20 cm
25	1	K 261.00	Cottle Retractor, 14 cm
26	1	K 583.00	Brünings Tongue Depressor, 19 cm
27	1	L 276.00	Cottle Nasal Speculum 35 x 7 mm, 13.5 cm
28	1	L 276.01	Cottle Nasal Speculum 55 x 7 mm, 13.5 cm
29	1	L 277.01	Cottle Nasal Speculum 55 x 7 mm, 13.5 cm
30	1	L 277.02	Cottle Nasal Speculum 76 x 7 mm, 13.5 cm
31	1	L 277.03	Cottle Nasal Speculum 90 x 7 mm, 13.5 cm
32	1	M 152.01	Freer Elevator, Sharp, 19 cm
33	1	M 193.01	Cottle Elevator, Sharp, 20 cm
34	1	M 196.01	Cottle Elevator, Sharp, 20 cm
35	1	M 232.01	Cottle Elevator, 19.5 cm
36	1	M 631.01	Cottle Chisel 4 mm, 18 cm
37	1	M 631.02	Cottle Chisel 7 mm, 18 cm
38	1	M 815.01	Cottle Metal Mallet 240 gr 18.5 cm
39	1	R 360.01	Weil-Blakesley Rongeur, Straight 3.6 mm, 12 cm
40	1	R 360.03	Weil-Blakesley Rongeur, Straight 4.8 mm, 12 cm
41	1	R 362.00	Weil-Blakesley Rongeur, Curved Upwards, 3.6 mm, 11 cm
42	1	R 365.00	Takahashi Rongeur, Straight, 12 cm
43	1	Y 310.15	1/2 Size Container, 285 x 280 x 150 mm
44	2	Y 390.05	Wire Baskets 255 x 245 x 50 mm
45	1	Z 065.00	Bipolar cord 2 mt.
46	1	Z 172.01	Bipolar Forceps, Insulated, 0.9 mm, 18.5 cm

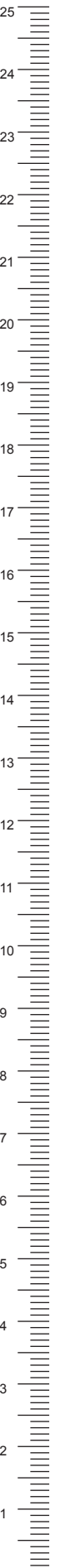

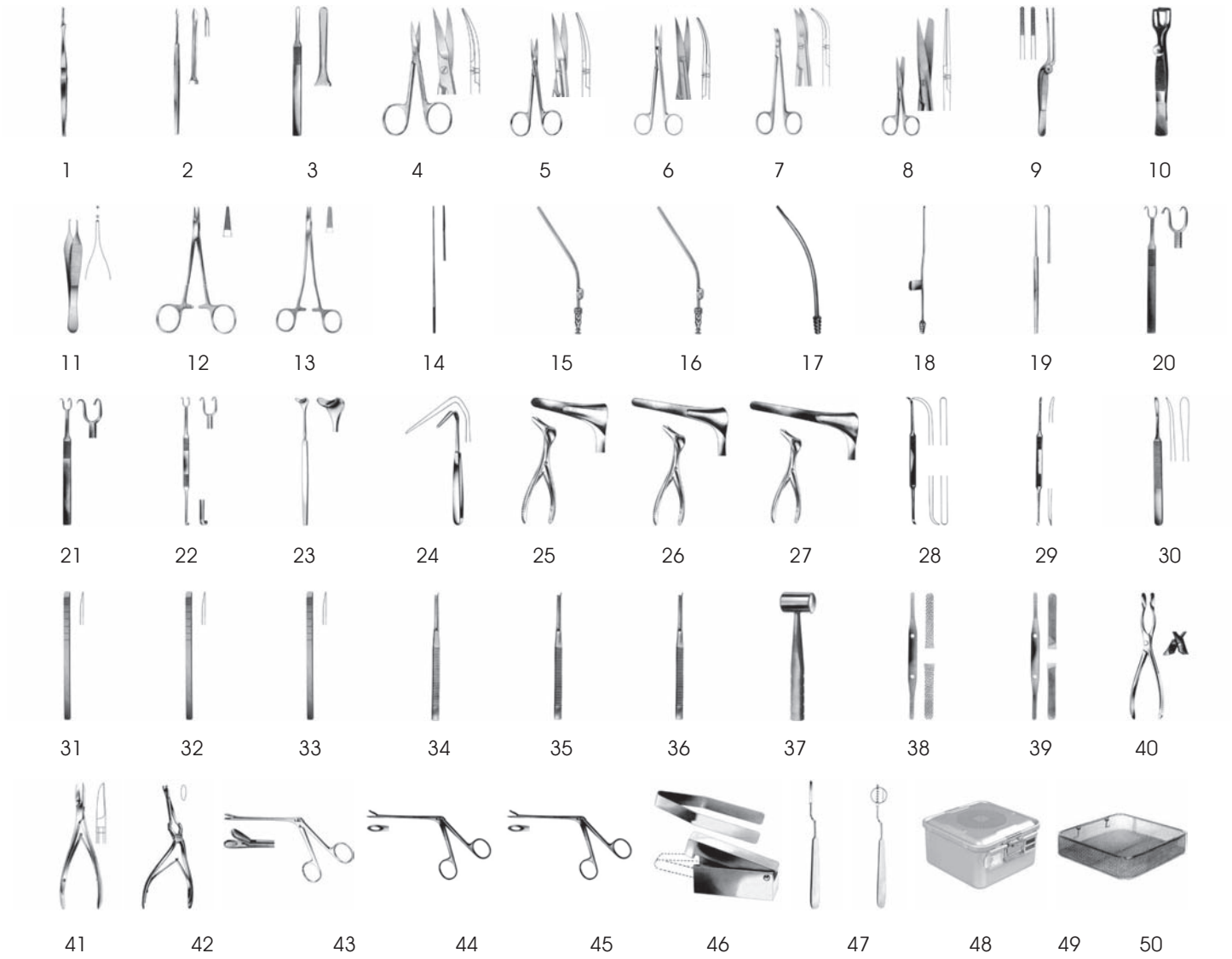

No	Quantity	Code	Description
1	1	B 033.00	Scalpel Handle, 3 No, 16 cm
2	1	B 130.00	Masing Nasal Knife, 13 cm
3	1	B 231.00	Cottle Nasal Knife, 14 cm
4	1	C 221.00	Delicate Scissors, curved, 9 cm
5	1	C 231.00	Delicate Scissors, curved, 11 cm
6	1	C 251.00	Joseph Delicate Scissors, curved, 15 cm
7	1	C 260.00	Chadwick Delicate scissors, curved, 11.5 cm
8	1	C 310.02	Scissors, straight, 13 cm
9	1	D 150.00	Cottle Forceps, Bayonet-Shaped, 14 cm
10	1	D 151.01	Cottle Camella Clamp, 10 cm
11	1	D 323.00	Adson Tissue Forcep, 12 cm
12	1	F 326.00	Converse Needle Holder, 13 cm
13	1	F 338.00	Sarot Needle Holder, 17.5 cm
14	3	J 056.02	Labhury-Farrel Cotton Applicator, Triangular Serrated
15	1	J 222.00	Frazier Suction Tube, With Luer Hub, Ø 3 mm, 18 cm
16	1	J 222.01	Frazier Suction Tube, With Luer Hub, Ø 5 mm, 18 cm
17	1	J 352.00	Suction Tube, With Luer Hub, 18 cm
18	1	J 360.00	Canulla, Sharp, 4 mm, 20 cm
19	1	K 134.00	Cottle Hook, 16 cm
20	1	K 212.00	Cottle Retractor, Right Sharp, 14.5 cm
21	1	K 214.00	Cottle Retractor, Left Sharp, 14.5 cm
22	1	K 215.00	Cottle Retractor, Blunt, 20 cm
23	1	K 261.00	Cottle Retractor, 14 cm
24	1	K 271.00	Aufricht Retractor, 16 cm
25	1	L 277.01	Cottle Nasal Speculum 55 x 7 mm, 13.5 cm
26	1	L 277.02	Cottle Nasal Speculum 76 x 7 mm, 13.5 cm
27	1	L 277.03	Cottle Nasal Speculum 90 x 7 mm, 13.5 cm
28	1	M 193.01	Cottle Elevator, 20 cm
29	1	M 195.01	Masing Elevator, 20 cm
30	1	M 214.00	Konig Raspatory, 5 mm, 15.5 cm
31	1	M 631.01	Cottle Chisel, 4 mm, 18 cm
32	1	M 631.02	Cottle Chisel, 7 mm, 18 cm
33	1	M 631.03	Cottle Chisel, 9 mm, 18 cm
34	1	M 642.00	Masing Chisel, Straight, 17.5 cm
35	1	M 642.01	Masing Chisel, Right, Curved, 17.5 cm
36	1	M 642.02	Masing Chisel, Left Curved, 17.5 cm
37	1	M 815.01	Cottle Metal Mallet, 240 gr. 18.5 cm
38	1	N 325.01	Fomon Raspatorie, 21.5 cm
39	1	N 326.01	Fomon Raspatorie, 21.5 cm
40	1	P 200.00	Cottle-Walsham Septum Forcep, 22 cm
41	1	P 355.00	Kazanjian Bone Rongeur, 18.5 cm
42	1	P 581.00	Jansen-Middleton Septum Bone Lever, 21 cm
43	1	R 343.02	Watson-Williams Rongeur, 8 mm, 12 cm
44	1	R 360.01	Weil-Blakesley Rongeur, 3.6 mm, 12 cm
45	1	R 360.03	Weil-Blakesley Rongeur, 4.8 mm, 12 cm
46	1	T 462.00	Bone Crusher
47	1	V 765.01	Joseph Nasal Saw, Curved to Right, 17 cm
48	1	V 765.02	Joseph Nasal Saw, Curved to Left, 17 cm
49	1	Y 310.15	1/2 Size Container, 285 x 280 x 150 mm
50	2	Y 390.05	Wire Baskets 255 x 245 x 50 mm

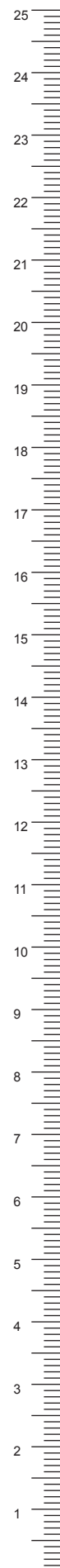

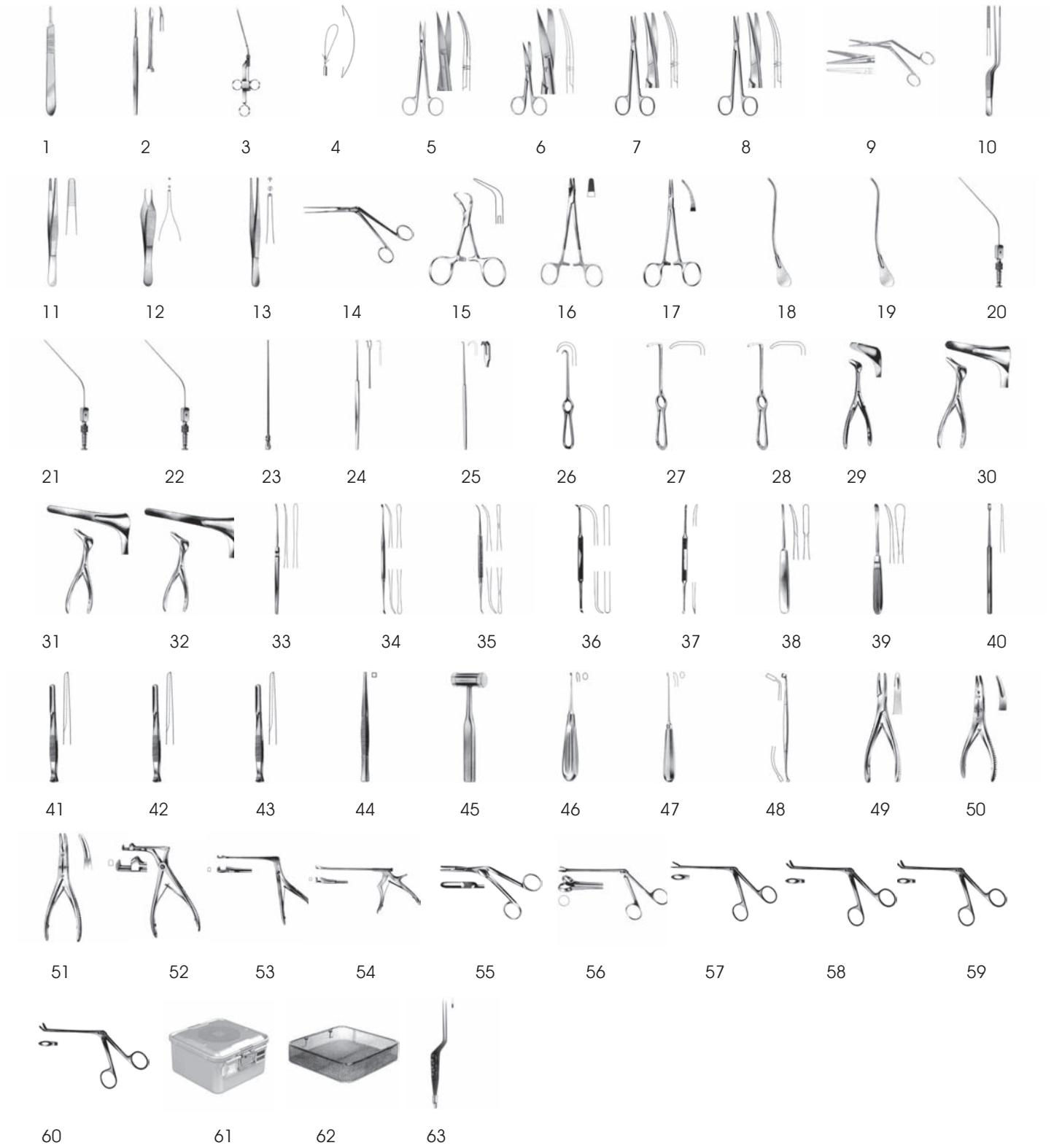

No	Quantity	Code	Description
1	1	B 030.01	Scalpel Handle 3 No, 13.5 cm
2	1	B 130.00	Masing Nasal Knife, Curved 13 cm
3	1	B 557.00	Krause Polypus Cutter, 25 cm
4	1	B 583.00	Snare Ware, package of 12 pcs Ø 0.3 mm
5	1	C 251.00	Joseph Scissors, curved, 15 cm
6	1	C 311.03	Scissors, Curved, 14.5 cm
7	1	C 421.00	Cottle-Knapp Scissors, curved, 14.5 cm
8	1	C 421.01	Cottle-Knapp Scissors, curved, 18 cm
9	1	C 560.00	Heyman-Khight Nasal Scissors 17.5 cm
10	2	D 148.00	Jansen Forcep 16 cm
11	2	D 240.02	Standart Dissecting Forcep, 14.5 cm
12	1	D 323.00	Adson Tissue Forcep, 12 cm
13	2	D 360.03	Standart Dissecting Forcep, 14.5 cm
14	1	E 285.00	Lubet-Barbon Dressing Forcep 20 cm
15	8	E 430.01	Backhaus Towel Clamp, 11 cm
16	2	F 334.00	Needle Holder, 15 cm
17	6	G 207.00	Micro-Halsted Curved 12.5 cm
18	1	J 026.01	Ritter Probe Ø 2.5 mm, 16 cm
19	1	J 026.02	Ritter Probe Ø 3.0 mm, 16 cm
20	1	J 214.01	Fergusson Suction Tube, With Luer Hub, Ø 2.5 mm, 18 cm
21	1	J 214.02	Fergusson Suction Tube, With Luer Hub, Ø 3.0 mm, 18 cm
22	1	J 214.03	Fergusson Suction Tube, With Luer Hub, Ø 4.0 mm, 18 cm
23	1	J 354.00	Wullstein Suction Tube, With Luer Hub 16 cm
24	2	K 128.00	Freer Retractor, 15 cm
25	2	K 168.01	Retractor, sharp, 16.5 cm
26	1	K 402.00	Kocher Retractor, Sharp, 22 cm
27	2	K 451.03	Langenbeck Retractor 33 x 14 mm, 21 cm
28	2	K 451.06	Langenbeck Retractor 40 x 13 mm, 21 cm
29	1	L 266.01	Hartmann-Halle Nasal Speculum 15.5 cm
30	1	L 277.01	Cottle Nasal Speculum 55 x 7 mm 13.5 cm
31	1	L 277.02	Cottle Nasal Speculum 76 x 7 mm 13.5 cm
32	1	L 277.03	Cottle Nasal Speculum 90 x 7 mm 13.5 cm
33	1	M 150.01	Halle Elevator, 18 cm
34	1	M 161.01	Freer Elevator, 18.5 cm
35	1	M 162.01	Freer-Yasargil Elevator, 18.5 cm
36	1	M 193.01	Cottle Elevator, 20 cm
37	1	M 195.01	Masing Elevator, 20 cm
38	1	M 219.01	Joseph Bone Level, 4 mm, 19 cm
39	1	M 232.01	Cottle Elevator, 19.5 cm
40	1	M 605.00	Freer Chisel 4 mm, 16 cm
41	1	M 621.01	Gouge, 4 mm, 14 cm
42	1	M 621.03	Gouge, 8 mm, 14 cm
43	1	M 621.04	Gouge, 10 mm, 14 cm
44	1	M 751.00	Passow Chisel 2 x 2 mm, 12 cm
45	1	M 801.00	Mallet Plastic Disk, 18.5 cm 140 gr
46	1	N 179.02	Wolkmann Bone Curette, 17 cm
47	1	N 187.02	Halle Antrum Curette, 21.5 cm
48	1	N 372.01	Faulkner Antrum Curette
49	1	P 277.00	Jansen Bone Rongeur, 17.5 cm
50	1	P 300.01	Böhler Bone Rongeur, 15.5 cm
51	1	P 302.00	Beyer Bone Rongeur, 18 cm
52	1	P 400.01	Citelli Punch, 6.5 cm
53	1	P 412.00	Hajek-Kofler Punch, 14 cm
54	1	P 415.00	Kofler Punch 14.5 cm
55	1	R 324.00	Craig Ronguer, Straight 16.5 cm
56	1	R 347.01	Hartman Ronguers Round, 12 cm
57	1	R 360.01	Weil-Blakesley Rongeurs, Straight, 12 cm
58	1	R 362.00	Weil-Blakesley Rongeurs, Curved Upwards, 11 cm
59	1	R 362.01	Weil-Blakesley Rongeurs, Curved Upwards, 11 cm
60	1	R 362.02	Weil-Blakesley Rongeurs, Curved Upwards, 11 cm
61	1	Y 310.15	1/2 Size Container 285 x 280 x 150
62	1	Y 390.03	Wire Baskets 255 x 245 x 30 mm
63	1	Y 390.07	Wire Baskets 255 x 245 x 70 mm
64	1	Z 160.14	Bipolar Forceps, Insulated, 1.0 mm, 19.5 cm

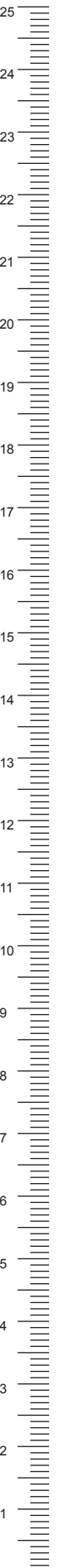

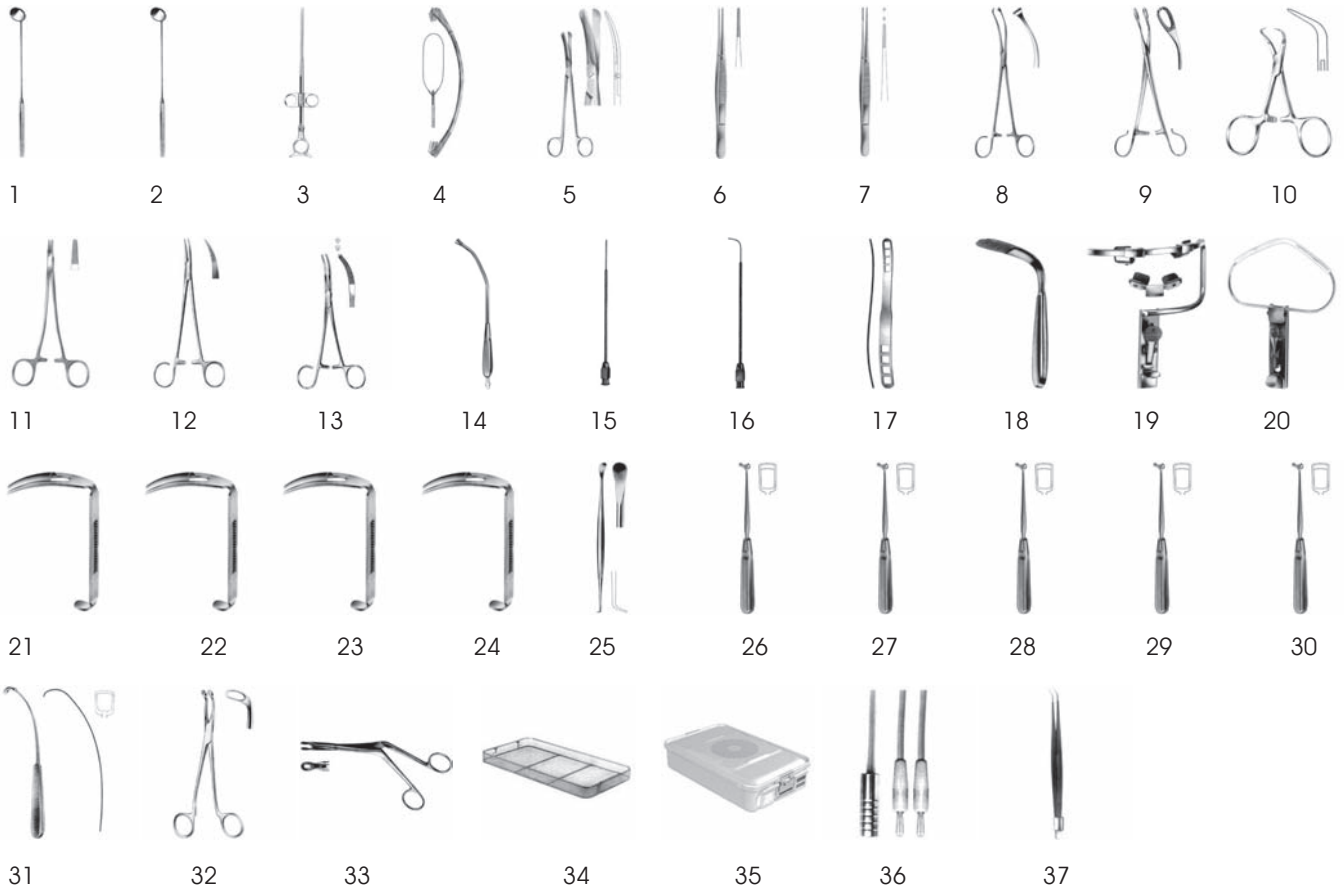

No	Quantity	Code	Description
1	1	A 300.03	Laryngeal Mirror, Ø 10 mm
2	1	A 300.06	Laryngeal Mirror, Ø 16 mm
3	1	B 240.00	Eyes Tonsil Snare, 25 cm
4	1	B 580.01	Wire Snare, Package of 12 pcs, Ø 0.5 mm
5	1	C 554.00	Good Scissors 19.5 cm
6	1	D 220.00	Cushing Dissecting Forcep 18 cm
7	1	D 382.01	Waugh Tissue Forcep, 20 cm
8	1	E 222.00	Marschik-Krone Forcep, 20.5 cm
9	1	E 225.00	Blohmke Forcep, 20.5 cm
10	6	E 430.01	Backhaus Towel Clamp, 11 cm
11	1	F 338.00	Sarot Needle Holder, 17.5 cm
12	1	G 461.00	Schmidt Forcep, Curved, 18.5 cm
13	1	G 466.00	Mikulicz Forcep, Curved, 18.5 cm
14	1	J 300.00	Yankauer Suction Tube 28.5 cm
15	1	J 725.00	Tonsil Needle, Straight
16	1	J 726.00	Tonsil Needle, Curved
17	1	K583.00	Brünings Tongue Depressor 19 cm
18	1	K 588.00	Tobold Tongue Depressor, 16 cm
19	1	L 160.00	Davis-Meyer Mouth Gag
20	1	L 165.00	Mclvor Mouth Gag
21	1	L 225.01	Russel-Davis Tongue Blade 29 x 67
22	1	L 225.02	Russel-Davis Tongue Blade 33 x 75
23	1	L 225.03	Russel-Davis Tongue Blade 38 x 85
24	1	L 225.04	Russel-Davis Tongue Blade 40 x 92
25	1	M 208.02	Henkel Dissector, 12 mm Wide, 23.5 cm
26	1	N 380.00	Beckmann Adenoid Curette, Straight, 20 cm
27	1	N 380.01	Beckmann Adenoid Curette, Straight, 20 cm
28	1	N 380.02	Beckmann Adenoid Curette, Straight, 20 cm
29	1	N 380.03	Beckmann Adenoid Curette, Straight, 20 cm
30	1	N 380.04	Beckmann Adenoid Curette, Sstraight, 20 cm
31	1	N 383.02	Negus Adenoid Curette, 20 cm
32	1	R 280.00	Jurasz Tonsil Forcep, 19 cm
33	1	R 328.03	Brünings Ronguer, Round, 19 cm
34	1	Y 290.05	Wire Basket, 405 x 255 x 50 mm
35	1	Y 210.10	3/4 Size Container, 465 x 280 x 100 mm
36	1	Z 065.00	Bipolar Cord, 2 mt.
37	1	Z 172.01	Bipolar Forcep, insulated, 19 cm

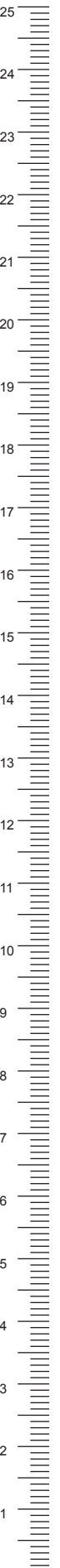



1



2



3



4



5



6



7



8



9



10



11



12



13



14



15



16



17



18



19



20



21



22



23



24



25



26



27



28



29



30



31



32



33



34



35



36



37



38



39



40



41



42



43



44



45



46



47



48



49



50



51

No	Quantity	Code	Description
1	1	B 030.01	Scalpel Handle, 3 No, 13.5 cm
2	1	C 251.00	Joseph Scissors, curved 15 cm
3	1	C 311.03	Scissors, curved, 14.5 cm
4	1	C 387.00	Reynolds Dissecting Scissors, curved, 14.5 cm
5	1	C 411.00	Cottle-Knapp Scissors, curved, blunt, 10.5 cm
6	1	C 421.01	Cottle-Knapp Scissors, 18 cm
7	1	C 695.00	Killian Scissors, both jaws serrated, 20cm
8	1	D 205.00	Adson Forceps, 12 cm
9	1	D 240.03	Standart Forceps, 16 cm
10	2	D 360.03	Standart Tissue Forceps, 14.5 cm
11	1	D 361.02	Tissue Forceps, 14.5 cm
12	1	D 361.03	Tissue Forceps, 16 cm
13	1	E 030.00	Duplay Dressing Forceps, 21 cm
14	6	E 430.01	Backhaus Towel Clamp, 11 cm
15	1	F 355.00	Hegar-Mayo Needle Holder, 15 cm
16	1	F 355.01	Hegar-Mayo Needle Holder, 18 cm
17	8	G 207.00	Micro-Halsted, Curved, 12.5 cm
18	2	G 240.00	Crille Forceps, straight, 14 cm
19	2	G 244.00	Crille Forceps, straight, 14 cm
20	1	G 264.00	Crille Forceps, straight, 16 cm
21	1	G 288.00	Birkett Forceps, straight, 18.5 cm
22	2	G 461.00	Schmidt Forceps, curved, 18.5 cm
23	2	J 056.01	Lathbury-Farrel Cotton Applicator, Triangular serrated, 14 cm
24	1	J 214.00	Fergusson Suction Tube, With Luer Hub, Ø 2.0 mm, 18 cm
25	1	J 214.02	Fergusson Suction Tube, With Luer Hub, Ø 3.0 mm, 18 cm
26	1	J 314.02	Siebenmann Canulla, Blunt, Ø 2.5 mm, 13 cm
27	1	J 350.01	Canulla, Ø 5.5 mm, 17.5 cm
28	1	J 354.00	Wullstein Suction Tube, With Luer Hub, 16 cm
29	1	J 381.01	Killian Cotton Carrier, curved, 25 cm
30	1	K 128.00	Freer Hook, 15 cm
31	1	K 134.00	Cottle Hook 16 cm
32	1	K 276.00	Kocher Retractor, 20.5 cm
33	2	K 451.03	Langenbeck Retractor, 33 x 14 mm, 21 cm
34	2	K 451.06	Langenbeck Retractor, 40 x 13 mm, 21 cm
35	1	K 583.00	Brünings Tongue Depressor, 19 cm
36	1	L 277.01	Cottle Nasal Speculum, 55 x 7 mm, 13.5 cm
37	1	L 277.02	Cottle Nasal Speculum, 76 x 7 mm, 13.5 cm
38	1	L 277.03	Cottle Nasal Speculum, 90 x 7 mm, 13.5 cm
39	1	L 326.00	Wullstein Self-Retaining Retractor, Blunt, 13 cm
40	1	L 331.02	Adson-Baby Self-Retaining Retractor, Blunt, 14 cm
41	1	M 161.01	Freer Elevator, 18.5 cm
42	1	M 219.01	Joseph Elevator, 17 cm
43	1	M 330.01	Konig Elevator, 15.5 cm
44	1	M 340.01	Qervain Elevator, 19.5 cm
45	1	R 347.01	Hartmann Ronguer, 12 cm
46	1	Y 310.13	1/2 Size Container, 285 x 280 x 135 mm
47	1	Y 390.03	Wire Basket, 255 x 245 x 30 mm
48	1	Y 390.07	Wire Basket, 255 x 245 x 70 mm
49	1	Z 065.00	Bipolar Cord, 2 mt.
50	1	Z 160.11	Bipolar Forcep, Insulated, 1.3 mm, 17.5 cm
51	1	Z 172.01	Bipolar Forcep, Insulated, 0.9 mm, 18.5 cm

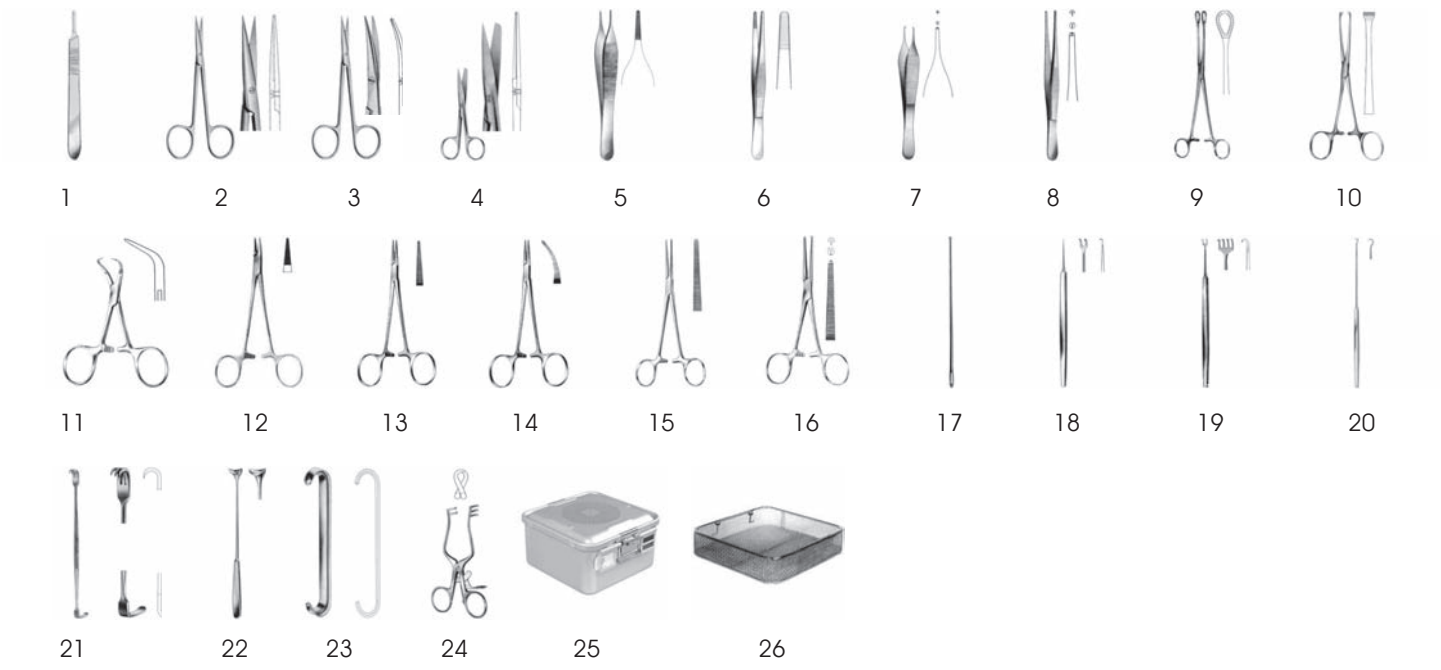

No	Quantity	Code	Description
1	2	B 030.01	Scalpel Handle 3 no, 13.5 cm
2	1	C 224.00	Delicate Scissors, Straight, 11.5 cm
3	1	C 225.00	Delicate Scissors, Curved, 11.5 cm
4	1	C 310.03	Surgical Scissors, Straight, 14.5 cm
5	1	D 205.00	Micro Adson Delicate Dissecting Forcep, 12 cm
6	1	D 240.02	Standart Dissecting Forcep, 14.5 cm
7	1	D 323.00	Adson Delicate Tissue Forcep, 12 cm
8	1	D 360.03	Standart Tissue Forcep, 14.5 cm
9	2	E 086.00	Foerster-Ballenger Organ and Tissue Forcep, Straight, 24 cm
10	6	E 144.00	Allis Tissue Grasping Forcep, 5x6 teeth, 15.5 cm
11	6	E 430.00	Backhaus Towel Clamp, 9 cm
12	1	F 328.00	Baby-Crile-wood Needle Holder, HM, 15 cm
13	12	G 206.00	Micro-Halsted Delicate Haemostatic Forcep, Straight, 12.5 cm
14	6	G 207.00	Micro-Halsted Delicate Haemostatic Forcep, Curved, 12.5 cm
15	6	G 264.00	Crile Delicate Haemostatic Forcep, Straight, 16 cm
16	2	G 438.00	Rochester—Ochsner Haemostatic Forcep, Straight, 14 cm
17	1	J 035.00	Probe, Ø 2.5 mm 14.5 cm
18	2	K 123.00	Guithrie Skin Hook, Sharp, 12.5 cm
19	2	K 124.01	Rollet Skin Hook, Sharp, 13.5 cm
20	2	K 138.00	Gillies Skin Hook, 18 cm
21	2	K 242.00	Senn-Miller Retractor, 18x6 mm 16.5 cm
22	2	K 274.00	Cushing Retractor, 11x14 mm, 25 cm
23	1	K 314.00	Parker Retractor, 13.5 cm
24	1	L 301.00	Weitlaner Self-Retaining Retractor, Blunt, 11 cm
25	1	Y 310.15	1/2 Size Container, 285 x 280 x 150 mm
26	1	Y 390.05	Wire Baskets, 255 x 245 x 50 mm

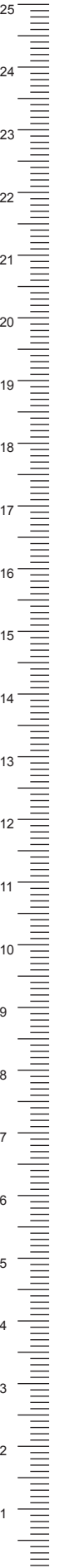

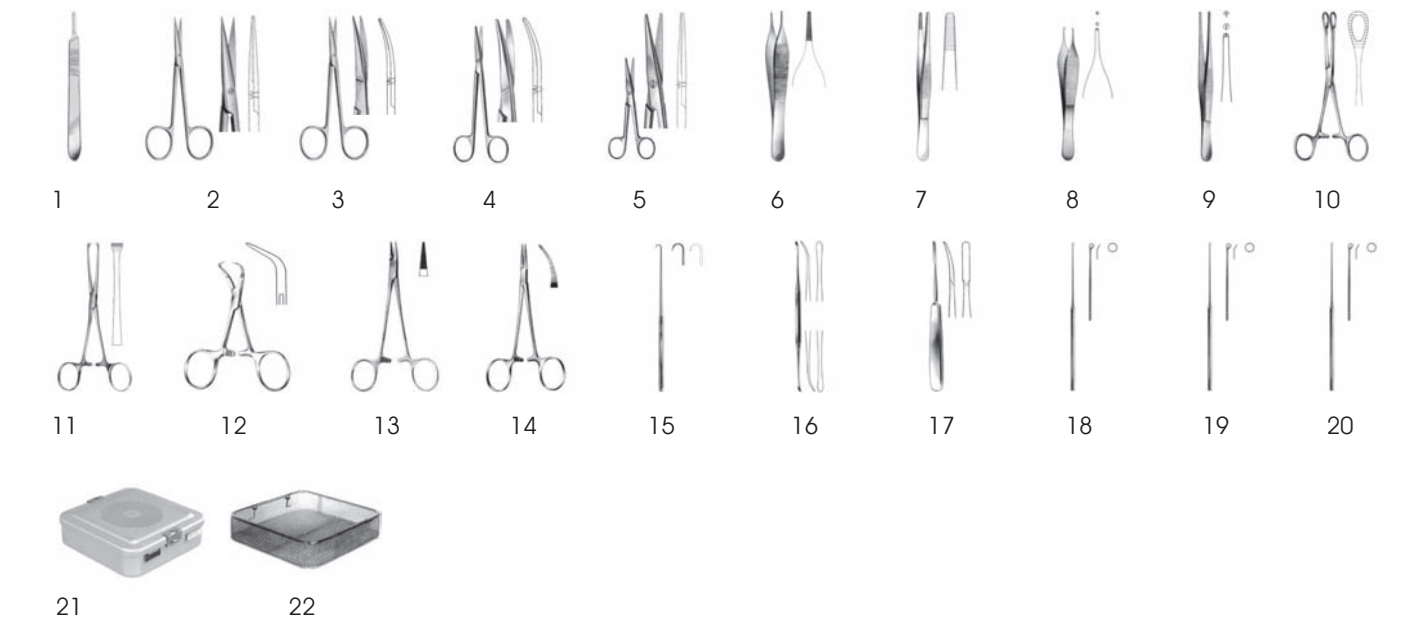



No	Quantity	Code	Description
1	2	B 030.01	Scalpel Handle 3 no, 13.5 cm
2	1	C 224.00	Delicate Scissors, Straight, 11.5 cm
3	1	C 225.00	Delicate Scissors, Curved, 11.5 cm
4	1	C 421.01	Metzenbaum Dissecting Scissors, Curved, 18 cm
5	1	C 442.00	Mayo-Stille Surgical Scissors, Straight, 14 cm
6	1	D 205.00	Micro Adson Delicate Dissecting Forcep, 12 cm
7	1	D 240.02	Standart Dissecting Forcep, 14.5 cm
8	1	D 323.00	Adson Delicate Tissue Forcep, 12 cm
9	1	D 360.03	Standart Tissue Forcep, 14.5 cm
10	2	E 082.00	Foerster-Ballenger Organ and Tissue Forcep, Straight 18 cm
11	4	E 144.00	Allis Tissue Grasping Forcep, 5x6 teeth, 15.5 cm
12	6	E 430.00	Backhaus Towel Clamp, 9 cm
13	1	F 328.00	Baby-Crile-wood Needle Holder, HM, 15 cm
14	6	G 207.00	Micro-Halsted Delicate Haemostatic Forcep, Curved, 12.5 cm
15	2	K 143.00	Joseph Dura Hook, 16.5 cm
16	1	M 161.01	Freer Raspatorie, Sharp/Blunt, 18.5 cm
17	1	M 219.01	Joseph Raspatorie, 4 mm, 17 cm
18	1	N 353.02	Buck Curette, Curved/Sharp, 2.5 mm, 15 cm
19	1	N 353.03	Buck Curette, Curved/Sharp, 3 mm, 15 cm
20	1	N 353.04	Buck Curette, Curved/Sharp, 4 mm, 15 cm
21	1	Y 310.08	Flat Container, 285 x 280 x 85 mm
22	1	Y 390.05	Wire Baskets, 255 x 245 x 50 mm

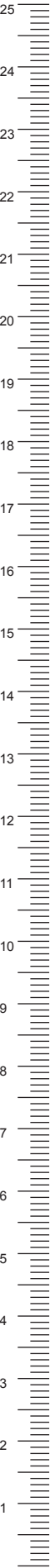

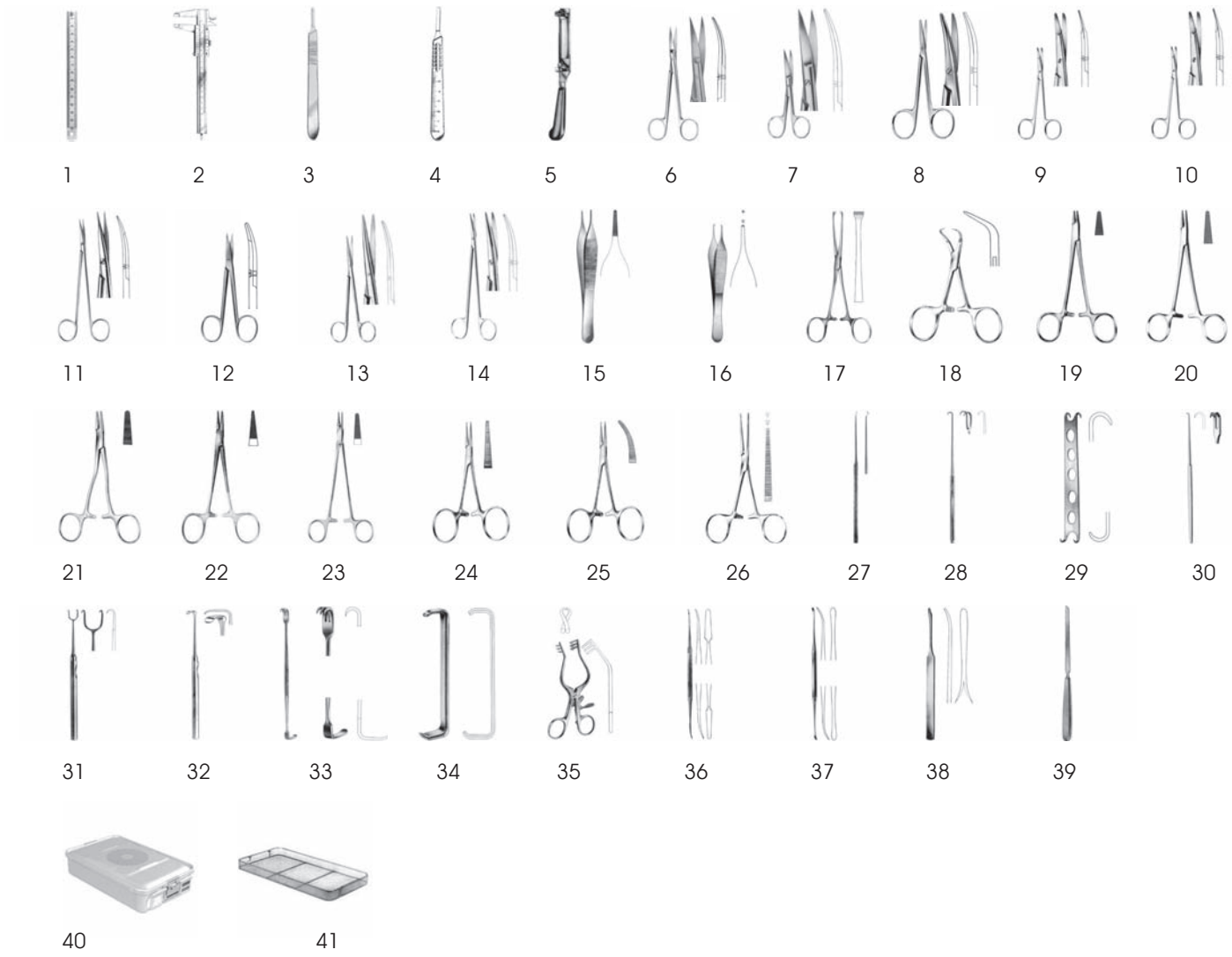

No	Quantity	Code	Description
1	1	A 500.01	Instrument for Measuring, 15 cm
2	1	A 510.00	Instrument for Measuring, Measuring 150 mm
3	1	B 030.01	Scalpel Handle 3 no, 13.5 cm
4	1	B 040.00	Scalpel Handle 4 no, 13.5 cm
5	1	B 182.00	Schinic Dermatome 30 cm
6	1	C 251.00	Joseph Delicate Scissors, Curved, Sharp, 15 cm
7	1	C 315.03	Surgical Scissors, Curved, 14.5 cm
8	1	C 366.00	Dissecting Scissors, Curved, 11.5 cm
9	1	C 382.00	Kilner Dissecting Scissors, 12.5 cm
10	1	C 382.01	Kilner Dissecting Scissors, 15 cm
11	2	C 386.00	Jameson Dissecting Scissors, 15 cm
12	1	C 393.00	Stevens Dissecting Scissors, Curved, Blunt, 11 cm
13	1	C 413.00	Baby-Metzenbaum Dissecting Scissors, Curved, 14.5 cm
14	1	C 416.00	Toennis-Adson Dissecting Scissors, Curved, 17.5 cm
15	1	D 205.00	Adson Delicate Dissecting Forcep, 12 cm
16	2	D 323.00	Adson Delicate Tissue Forcep, 12 cm
17	1	E 144.00	Allis Tissue Grasping Forcep, 5x6 teeth, 15.5 cm
18	4	E 430.01	Backhaus Towel Clamp, 11 cm
19	1	F 210.00	Baumgartner Needle Holder, 14.5 cm
20	2	F 219.00	Crile-Murkay Needle Holder, 15 cm
21	1	F 221.00	Kilner Needle Holder, 13.5 cm
22	1	F 325.00	Halsey Needle Holder, HM, 13 cm
23	1	F 355.00	Hegar-Mayo Needle Holder, 15 cm
24	5	G 200.00	Baby-Mosquito Delicate Haemostatic Forcep, Straight, 10 cm
25	5	G 201.00	Baby-Mosquito Delicate Haemostatic Forcep, Curved, 10 cm
26	1	G 440.01	Kocher Haemostatic Forcep, Straight, 13 cm
27	1	K 127.00	Kilner Skin Hook, 16 cm
28	1	K 143.03	Joseph Dura Hook, 16.5 cm
29	1	K 151.00	Converse Skin Hook, Blunt, 12 cm
30	1	K 168.01	Retractor, Small, Sharp, 16.5 cm
31	1	K 177.00	Mannerfelt Retractor, Sharp, 15.5 cm
32	1	K 191.03	Langenbeck-Mannerfelt Retractor, 30 x 8 mm, 15.5 cm
33	1	K 242.00	Senn-Miller Retractor, 18x6 mm 16.5 cm
34	2	K 310.00	Farabeuf Retractor, 12.5 cm
35	1	L 325.00	Wullstein Self-Retaining Retractor, Sharp, 13 cm
36	1	M 160.01	Killian Raspatorie, Sharp/Blunt, 18.5 cm
37	1	M 161.01	Freer Raspatorie, Sharp/Blunt, 18.5 cm
38	1	M 330.01	König Bone Level, 4.5 mm, 15.5 cm
39	1	T 600.00	Langenbeck Nasal Saw, Straight, 23.5 cm
40	1	Y 210.10	3/4 Container, 465 x 280 x 100 mm
41	1	Y 290.03	Wire Baskets, 405 x 255 x 30 mm



No	Quantity	Code	Description
1	1	B 030.02	Scalpel Handle 3 no, 21.5 cm
2	1	C 798.00	Scissors, One Jaw Serrated, 12 cm
3	4	E 430.01	Backhaus Towel Clamp, 11 cm
4	1	F 447.01	Sanders-Brown Awl, 30 cm
5	1	K 350.00	Obwegeser Retractor, 8 mm, 16 cm
6	1	K 351.00	Obwegeser Retractor, 16 cm
7	1	L 155.01	Dingman Mouth Gag, Frame only
8	1	L 228.01	Mclvor Tongue Depressor, 25x55 mm
9	1	L 228.02	Mclvor Tongue Depressor, 25x62 mm
10	1	L 228.03	Mclvor Tongue Depressor, 25x75 mm
11	2	M 216.00	Williger Raspatorie, 6 mm, 16 cm
12	1	M 272.01	Raspatorie, 4 mm, 14 cm
13	1	M 273.01	Raspatorie, 4 mm, 14 cm
14	1	M 615.02	Osteotome 6 mm, 14 cm
15	1	Y 310.10	3/4 Container, 285 x 280 x 100 mm
16	1	Y 390.05	Wire Baskets, 255 x 245 x 50 mm

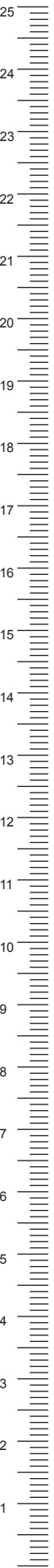

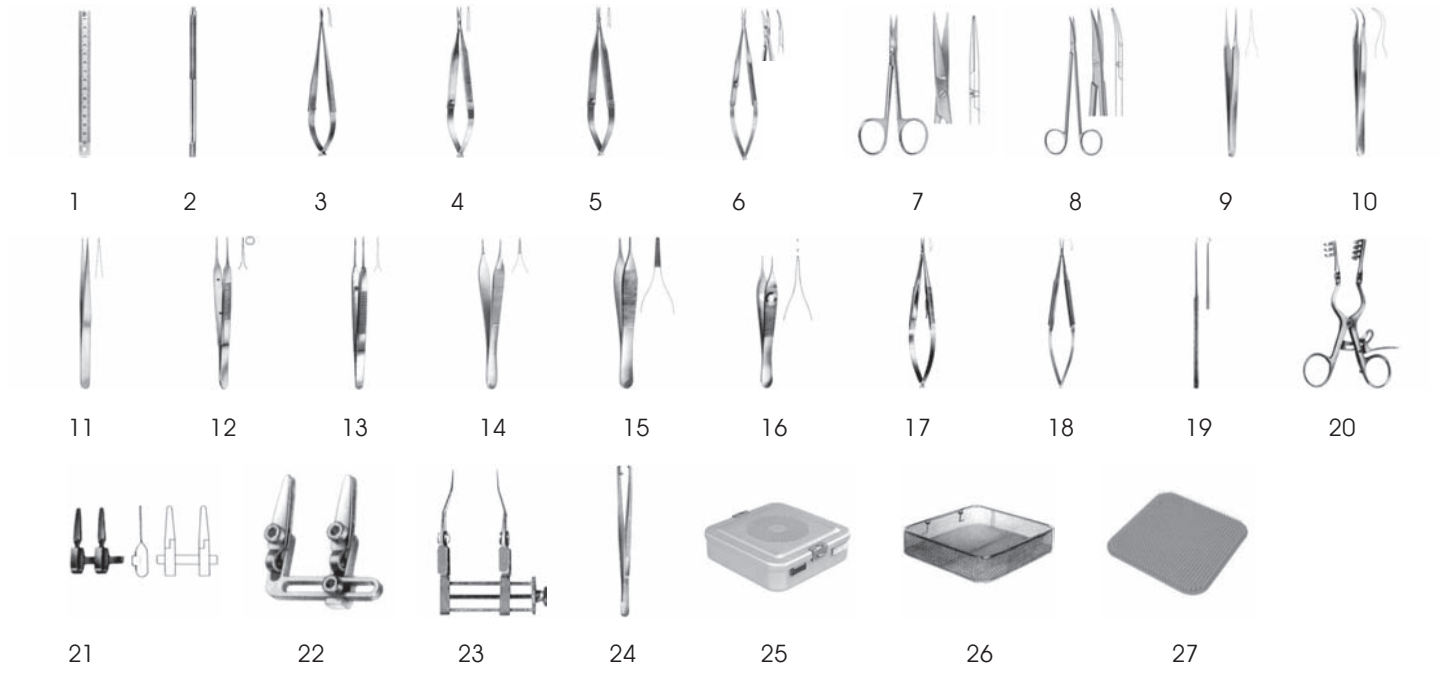

No	Quantity	Code	Description
1	1	A 500.01	Instrument for Measuring, 15 cm
2	1	B 010.00	Scalpel Handle, 13.5 cm
3	2	C 101.00	Micro Scissors, Curved, 10.5 cm
4	1	C 103.00	Micro Scissors, Curved, 12 cm
5	1	C 106.00	Vannas Micro Scissors, Straight, 12 cm
6	1	C 113.00	Micro Scissors, Curved, 16 cm
7	1	C 222.00	Delicate Scissors, Straight, 9.5 cm
8	1	C 258.00	Delicate Scissors Curved, 15 cm
9	1	D 103.00	Micro Suture Tying Forcep, 0.2 mm 11 cm
10	1	D 105.00	Micro Suture Tying Forcep, 0.2 mm 11.5 cm
11	2	D 107.00	Micro Suture Tying Forcep, 0.3 mm 12 cm
12	1	D 124.00	Micro Suture Tying Forcep, 1x2 teeth 0.2 mm 9.5 cm
13	1	D 125.00	Austin Micro Suture Tying Forcep, 0.8 mm 14 cm
14	1	D 204.00	Micro-Adson Delicate Dissecting Forcep, 12 cm
15	1	D 205.00	Adson Delicate Dissecting Forcep, 12 cm
16	1	D 326.00	Adson Delicate Tissue Forcep, 12 cm
17	1	F 121.00	Barraquer Micro Needle Holder, With Catch, 12 cm
18	1	F 127.00	Reill Micro Needle Holder, Without Catch, 15 cm
19	1	K 127.00	Kilner Skin Hook, 16 cm
20	1	L 331.02	Adson-Baby Self-Retaining Retractor, Blunt, 14 cm
21	1	S 013.00	Biemer-Muller Approximator, Jaw 9 mm, Opening 5 mm, Closing Force 25-30 gr
22	1	S 025.00	Approximator complete, with key
23	3	S 030.00	Approximator
24	2	S 035.00	Biemer Vessel Clip, 14.5 cm
25	1	Y 310.08	Flat Container, 285 x 280 x 85 mm
26	1	Y 390.03	Wire Baskets, 255 x 245 x 30 mm
27	1	Y 851.00	Silicon mat 245 X 245 mm



1



2



3



4



5



6



7



No	Quantity	Code	Description
1	1	B 032.00	Scalpel Handle 3 no, 16.5 cm
2	2	E 082.00	Foerster-Ballenger Organ and Tissue Forcep, Straight 18 cm
3	4	E 430.00	Backhaus Towel Clamp, 9 cm
4	2	G 460.01	Schmidt Haemostatic Forcep, 18.5 cm
5	1	K 589.00	Wieder Tongue Depressor, 14 cm
6	1	K 589.01	Wieder Tongue Depressor, 15 cm
7	1	Y 410.07	Mini Container, 300 x 140 x 70 mm

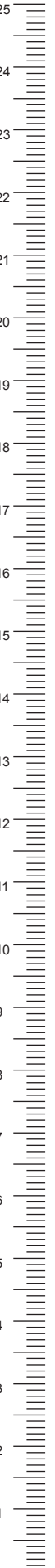



1



2



3



4



5



6



7



8



No	Quantity	Code	Description
1	1	C 442.01	Mayo Stille Surgical Scissors, Straight, 17 cm
2	2	E 082.00	Foerster-Ballenger Organ and Tissue Forcep, Straight 18 cm
3	1	F 346.00	De Bakey Needle Holder, HM, 18 cm
4	6	G 460.01	Schmidt Haemostatic Forcep, 18.5 cm
5	1	J 301.00	Yankauer Suction Tube, Ø 2 mm 28.5 cm
6	1	K 589.01	Wieder Tongue Depressor, 15 cm
7	1	M 205.02	Hurd Raspatorie, 6 mm, 21.5 cm
8	1	Y 410.07	Mini Container, 300 x 140 x 70 mm

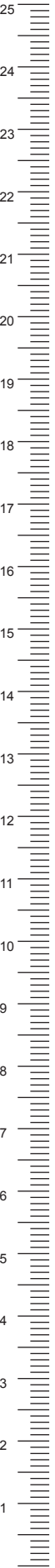

0-9

Sayısal İndeks
Numerical Index

Kat. No. Cat. No.	Sayfa. Page.	Kat. No. Cat. No.	Sayfa. Page.	Kat. No. Cat. No.	Sayfa. Page.	Kat. No. Cat. No.	Sayfa. Page.
A 250.00	86	A 300.08	182	B 030.02	5	B 081.05	105
A 250.01	86	A 300.09	182	B 032.00	3	B 082.01	105
A 250.02	86	A 300.10	182	B 033.00	3	B 083.01	105
A 250.03	86	A 300.11	182	B 034.00	5	B 084.01	105
A 251.00	86	A 300.12	182	B 034.01	5	B 085.01	105
A 251.01	86	A 300.13	182	B 040.00	6	B 085.03	105
A 251.02	86	A 302.01	182	B 040.01	6	B 086.01	105
A 251.03	86	A 302.02	182	B 040.02	6	B 086.03	105
A 251.04	86	A 302.03	182	B 043.00	6	B 105.00	78
A 251.05	86	A 302.04	182	B 043.01	6	B 122.00	175
A 251.06	86	A 302.05	182	B 045.00	6	B 125.00	175
A 251.07	86	A 302.06	182	B 050.00	4	B 126.00	175
A 252.00	86	A 302.07	182	B 052.00	4	B 128.00	151
A 252.01	86	A 302.08	182	B 080.00	102	B 128.01	151
A 252.02	86	A 302.09	182	B 080.01	102	B 130.00	132
A 252.03	86	A 302.10	182	B 080.02	102	B 134.00	132
A 253.00	86	A 302.11	182	B 080.03	102	B 135.00	132
A 253.01	86	A 302.12	182	B 080.04	102	B 180.00	7
A 253.02	86	A 302.13	182	B 080.05	102	B 182.00	7
A 253.03	86	A 304.00	182	B 080.06	103	B 184.00	7
A 253.04	86	A 306.00	182	B 080.07	103	B 186.00	7
A 254.01	86	A 308.01	182	B 080.08	103	B 188.00	7
A 254.02	86	A 308.02	182	B 080.09	103	B 220.00	93
A 255.01	87	A 308.03	182	B 080.10	103	B 221.00	93
A 255.02	87	A 308.04	182	B 080.11	103	B 221.01	93
A 255.03	87	A 500.00	2	B 080.13	103	B 221.02	93
A 255.04	87	A 500.01	2	B 080.15	103	B 222.00	93
A 256.00	87	A 500.03	2	B 080.17	103	B 223.00	93
A 256.01	87	A 500.04	2	B 080.18	103	B 225.00	93
A 256.02	87	A 510.00	2	B 080.20	103	B 230.00	132
A 256.03	87	A 516.00	2	B 080.22	103	B 231.00	132
A 256.04	87	A 516.01	2	B 080.23	103	B 232.00	132
A 256.05	87	A 518.00	2	B 080.24	103	B 233.00	132
A 256.06	87	A 520.00	72	B 080.25	103	B 234.00	132
A 256.07	87	A 520.01	72	B 080.26	103	B 240.00	171
A 256.08	87	A 520.02	72	B 080.27	103	B 241.00	171
A 257.01	87	A 520.03	72	B 080.29	103	B 242.01	171
A 257.02	87	A 520.04	72	B 080.30	103	B 250.00	188
A 257.03	87	A 521.00	72	B 080.31	104	B 250.01	188
A 257.04	87	A 521.01	72	B 080.32	104	B 250.02	188
A 257.05	87	A 521.02	72	B 080.34	104	B 250.03	188
A 257.06	87	A 521.03	72	B 080.35	104	B 250.04	188
A 258.00	87	A 521.04	72	B 080.37	104	B 250.05	188
A 258.01	87			B 080.38	104	B 250.06	188
A 258.02	87			B 080.40	104	B 250.08	188
A 258.03	87	B 010.00	3	B 080.41	104	B 252.00	132
A 258.04	87	B 012.00	3	B 080.42	104	B 255.00	188
A 258.05	87	B 014.00	3	B 080.43	104	B 260.00	132
A 300.01	182	B 016.00	3	B 080.45	104	B 480.01	137
A 300.02	182	B 018.00	3	B 080.46	104	B 480.02	137
A 300.03	182	B 020.00	4	B 080.47	104	B 480.03	137
A 300.04	182	B 022.00	4	B 080.49	104	B 481.01	137
A 300.05	182	B 024.00	4	B 080.50	104	B 481.02	137
A 300.06	182	B 030.00	5	B 080.51	104	B 481.03	137
A 300.07	182	B 030.01	5	B 081.02	105	B 555.00	128

Kat. No. Cat. No.	Sayfa. Page.	Kat. No. Cat. No.	Sayfa. Page.	Kat. No. Cat. No.	Sayfa. Page.	Kat. No. Cat. No.	Sayfa. Page.
B 556.00	128	C 239.00	10	C 390.00	16	C 715.00	20
B 556.01	128	C 250.00	10-131	C 391.00	16	C 720.03	20
B 556.02	128	C 251.00	10-131	C 392.00	16	C 721.03	20
B 556.04	128	C 258.00	10	C 393.00	16	C 722.00	22
B 557.00	128	C 260.00	11	C 410.00	17	C 723.03	20
B 560.00	93	C 261.00	11	C 411.00	17	C 725.00	22
B 561.00	93	C 264.00	11	C 412.00	17	C 726.00	22
B 565.00	93	C 265.00	11-131	C 413.00	17	C 730.00	22
B 580.00	171	C 266.00	11-131	C 416.00	18	C 731.00	22
B 580.01	171	C 268.00	11	C 416.01	18	C 750.00	21
B 583.00	128	C 269.00	11	C 418.00	18	C 751.00	21
B 585.00	128	C 310.01	12	C 418.01	18	C 752.00	21
B 588.00	171	C 310.02	12	C 419.00	18	C 753.00	21
		C 310.03	12	C 420.00	17	C 755.00	21
		C 310.04	12	C 420.01	17	C 756.00	21
C 080.01	117	C 311.01	13	C 420.02	17	C 756.01	21
C 080.02	117	C 311.02	13	C 421.00	17	C 758.00	21
C 080.04	117	C 311.03	13	C 421.01	17	C 761.00	22
C 080.05	117	C 311.04	13	C 421.02	17	C 798.00	23
C 080.06	117	C 311.05	13	C 423.00	18		
C 080.07	117	C 312.02	12	C 430.00	131		
C 080.10	117	C 312.03	12	C 430.01	131		
C 080.11	117	C 312.04	12	C 431.00	131	D 103.00	24
C 080.13	117	C 312.05	12	C 435.00	18-131	D 103.01	24
C 080.14	117	C 313.01	13	C 440.01	19	D 104.00	24
C 080.15	117	C 313.02	13	C 441.01	19	D 105.00	24
C 080.16	117	C 313.03	13	C 441.02	19	D 106.00	24
C 080.17	117	C 313.04	13	C 442.01	19	D 107.00	24
C 090.00	185	C 313.05	13	C 455.00	19	D 108.00	24
C 091.00	185	C 314.02	14	C 459.02	19	D 127.00	24
C 092.00	185	C 314.03	14	C 530.00	130	D 128.00	24
C 093.00	185	C 315.02	14	C 550.00	170	D 130.00	24
C 096.00	185	C 315.03	14	C 551.00	170	D 130.01	24
C 098.00	185	C 316.00	14	C 554.00	170	D 131.00	24
C 102.00	8	C 316.01	14	C 556.00	170	D 131.01	24
C 103.00	8	C 317.00	14	C 560.00	129	D 147.00	33
C 112.00	8	C 317.01	14	C 561.00	129	D 148.00	33
C 113.00	8	C 341.01	154	C 562.00	129	D 149.00	33
C 116.00	8	C 342.01	154	C 564.00	130	D 150.00	33
C 117.00	8	C 342.02	154	C 566.00	130	D 151.01	28
C 120.00	8	C 360.00	15	C 569.00	170	D 154.00	33
C 121.00	8	C 365.00	15	C 622.00	23	D 156.00	32
C 220.00	9	C 366.00	15	C 625.00	23	D 156.01	32
C 221.00	9	C 368.00	15	C 625.01	23	D 156.02	32
C 222.00	9	C 370.00	15	C 625.02	23	D 156.03	32
C 223.00	9	C 371.00	15	C 640.00	23	D 157.00	32
C 224.00	9	C 380.00	15	C 640.01	23	D 158.00	32
C 230.00	9	C 382.00	15	C 643.00	23	D 159.00	32
C 231.00	9	C 382.01	15	C 666.00	23	D 204.00	25
C 232.00	9	C 385.00	16	C 668.00	23	D 205.00	25
C 233.00	9	C 386.00	16	C 695.00	217	D 207.00	25
C 235.00	10	C 387.00	16	C 695.01	217	D 209.00	25
C 236.00	10	C 387.01	16	C 711.00	20	D 210.00	25
C 237.00	10	C 388.00	16	C 712.00	20	D 212.00	25
C 238.00	10	C 389.00	16	C 713.00	20	D 215.02	25

Kat. No. Cat. No.	Sayfa. Page.	Kat. No. Cat. No.	Sayfa. Page.	Kat. No. Cat. No.	Sayfa. Page.	Kat. No. Cat. No.	Sayfa. Page.
D 215.03	25	D 360.01	30	E 055.00	34	F 123.00	38
D 215.04	25	D 360.02	30	E 124.00	161	F 124.00	38
D 218.00	25	D 360.03	30	E 125.00	161	F 125.00	38
D 218.01	25	D 360.04	30	E 143.00	35	F 126.00	38
D 220.00	26	D 360.05	30	E 144.00	35	F 127.00	38
D 220.01	26	D 360.06	30	E 145.00	35	F 130.00	38
D 220.02	26	D 360.07	30	E 165.00	172	F 131.00	38
D 230.00	25	D 361.00	29	E 188.00	161	F 203.00	39
D 232.00	25	D 361.01	29	E 193.00	161	F 204.00	39
D 233.00	25	D 361.02	29	E 201.00	35	F 206.00	39
D 236.00	25	D 361.03	29	E 202.00	35	F 210.00	39
D 240.00	26	D 362.00	29	E 206.00	35	F 215.00	39
D 240.01	26	D 365.00	29	E 220.00	173	F 219.00	39
D 240.02	26	D 365.01	29	E 221.00	173	F 220.00	218
D 240.03	26	D 366.00	29	E 222.00	173	F 236.00	39
D 240.04	26	D 370.00	30	E 223.00	173	F 269.00	43
D 240.05	26	D 370.01	30	E 224.00	172	F 325.00	40
D 240.06	26	D 370.02	30	E 225.00	172	F 326.00	40
D 242.00	26	D 370.03	30	E 230.00	172	F 328.00	40
D 244.00	26	D 370.04	30	E 280.00	89	F 332.00	41
D 244.01	26	D 371.00	30	E 280.01	126	F 333.00	40
D 244.02	26	D 371.01	30	E 281.00	89	F 334.00	41
D 244.03	26	D 371.02	30	E 281.01	126	F 336.00	41
D 246.00	26	D 380.00	31	E 282.00	89	F 338.00	41
D 246.01	26	D 381.00	29	E 283.01	126	F 342.00	43
D 260.00	27	D 382.00	31	E 284.00	127	F 343.01	43
D 260.02	27	D 382.01	31	E 285.00	127	F 344.00	41
D 262.00	27	D 382.02	31	E 302.00	36	F 344.01	41
D 262.01	27	D 382.03	31	E 302.01	36	F 345.00	41
D 263.00	27	D 387.00	31	E 311.00	36	F 345.01	41
D 263.01	27	D 412.00	31	E 312.00	36	F 346.00	41
D 265.00	27	D 503.00	31	E 330.00	36	F 347.00	42
D 265.01	27	D 503.02	31	E 331.00	36	F 347.01	42
D 268.00	27	D 504.00	31	E 331.01	36	F 347.02	42
D 268.01	27	D 504.02	31	E 332.00	36	F 355.00	42
D 303.00	29	D 510.00	31	E 332.01	36	F 355.01	42
D 304.00	29	D 510.01	31	E 400.01	37	F 355.02	42
D 309.00	29	D 512.00	31	E 402.00	37	F 356.00	42
D 309.01	29	D 512.01	31	E 430.00	37	F 380.00	42
D 310.00	29	D 570.00	210	E 430.01	37	F 380.01	42
D 314.00	29	D 571.00	210	E 430.02	37	F 380.02	42
D 314.01	29	D 572.00	210	E 440.00	37	F 380.03	42
D 320.00	28			E 442.00	37	F 381.00	42
D 322.00	28			E 450.00	37	F 381.01	42
D 323.00	28	E 007.00	126	E 451.00	37	F 381.02	42
D 324.00	28	E 019.00	34			F 391.00	43
D 325.01	28	E 022.00	34			F 391.01	43
D 327.00	28	E 023.00	34	F 110.00	38	F 392.00	43
D 329.00	28	E 030.00	34-172	F 111.00	38	F 392.01	43
D 340.00	28	E 031.00	172	F 112.00	38	F 392.02	43
D 341.00	28	E 032.01	183	F 116.00	38	F 396.00	43
D 350.00	31	E 033.01	183	F 117.00	38	F 420.00	44
D 351.00	30	E 042.00	34	F 120.00	38	F 421.00	44
D 351.01	28	E 043.00	34	F 121.00	38	F 422.00	44
D 352.01	30	E 054.00	34	F 122.00	38	F 423.00	44

Kat. No. Cat. No.	Sayfa. Page.	Kat. No. Cat. No.	Sayfa. Page.	Kat. No. Cat. No.	Sayfa. Page.	Kat. No. Cat. No.	Sayfa. Page.
F 424.00	44	G 218.00	48	G 614.00	53	J 045.00	54
F 425.00	44	G 219.00	48	G 615.00	53	J 047.00	54
F 432.00	44	G 220.00	48	G 616.00	53	J 049.00	54
F 433.00	44	G 221.00	48	G 616.01	53	J 049.01	54
F 447.00	218	G 226.00	48	G 617.00	53	J 049.02	54
F 447.01	218	G 227.00	48	G 618.00	53	J 049.03	54
F 451.00	176	G 230.00	49	G 618.01	53	J 049.04	54
F 457.00	218	G 231.00	49	G 618.02	53	J 050.00	90
F 458.00	218	G 234.00	49	G 618.03	53	J 051.00	90
F 459.00	218	G 235.00	49			J 052.01	90
F 462.00	192	G 240.00	49			J 052.05	127
F 462.01	192	G 241.00	49			J 052.06	127
F 480.00	45	G 244.00	49	J 001.01	111	J 053.00	90
F 481.00	45	G 245.00	49	J 001.02	111	J 053.01	90
F 482.00	45	G 250.00	49	J 001.04	111	J 055.00	90
F 488.00	45	G 251.00	49	J 001.05	111	J 055.01	90
F 489.00	45	G 254.00	49	J 003.01	112	J 055.02	127
		G 255.00	49	J 004.01	112	J 056.00	90
		G 264.00	50	J 010.00	54	J 056.01	90
		G 265.00	50	J 010.01	54	J 056.02	127
G 010.00	47	G 268.00	50	J 010.02	54	J 059.00	127
G 010.01	47	G 269.00	50	J 015.00	54	J 060.00	92
G 010.02	47	G 278.00	49	J 020.00	55	J 060.01	92-127
G 011.00	47	G 279.00	49	J 020.01	55	J 108.00	60
G 011.01	47	G 280.00	50	J 020.02	55	J 110.00	60
G 011.02	47	G 281.00	50	J 020.03	55	J 113.01	60
G 012.00	47	G 288.00	50	J 024.00	55	J 113.02	60
G 013.00	47	G 289.00	50	J 026.01	54	J 114.01	60
G 013.01	47	G 294.00	50	J 026.02	54	J 114.02	60
G 020.00	47	G 295.00	50	J 026.03	54	J 116.00	60
G 020.01	47	G 420.00	51	J 026.04	54	J 117.00	60
G 021.00	47	G 420.01	51	J 030.00	54	J 126.00	60
G 021.01	47	G 421.00	51	J 030.01	54	J 190.00	91
G 022.00	47	G 421.01	51	J 030.02	54	J 190.01	91
G 023.00	47	G 423.01	51	J 030.03	54	J 190.02	91
G 024.00	47	G 424.00	51	J 030.04	54	J 190.03	91
G 024.01	47	G 430.00	51	J 033.01	55	J 190.04	91
G 024.02	47	G 431.00	51	J 033.07	55	J 190.05	91
G 024.03	47	G 438.00	51	J 033.08	55	J 190.06	91
G 024.04	47	G 439.00	51	J 033.09	55	J 192.00	91
G 024.05	47	G 440.01	52	J 033.10	55	J 192.01	91
G 024.06	47	G 441.00	52	J 033.11	55	J 192.02	91
G 026.00	47	G 444.00	52	J 033.12	55	J 192.03	91
G 030.00	47	G 445.00	52	J 033.15	55	J 192.05	91
G 030.01	47	G 454.00	52	J 033.16	55	J 193.00	91
G 200.00	48	G 455.00	52	J 033.17	55	J 194.00	91
G 201.00	48	G 456.00	52	J 033.18	55	J 195.00	91
G 204.00	48	G 457.00	52	J 033.20	55	J 196.01	91
G 205.00	48	G 460.00	174	J 035.00	55	J 196.02	91
G 206.00	48	G 460.01	174	J 035.01	55	J 196.03	91
G 207.00	48	G 461.00	174	J 035.02	55	J 196.05	91
G 210.00	48	G 461.01	174	J 038.00	55	J 196.06	91
G 211.00	48	G 464.00	174	J 038.01	55	J 196.07	91
G 214.00	48	G 464.01	174	J 042.00	55	J 212.00	56
G 215.00	48	G 466.00	174	J 043.00	54	J 212.01	56

Kat. No. Cat. No.	Sayfa. Page.	Kat. No. Cat. No.	Sayfa. Page.	Kat. No. Cat. No.	Sayfa. Page.	Kat. No. Cat. No.	Sayfa. Page.
J 212.02	56	J 320.01	91	J 473.01	61	K 050.10	107
J 212.03	56	J 320.02	91	J 473.02	61	K 050.11	107
J 214.00	56	J 320.03	91	J 473.03	61	K 050.12	107
J 214.01	56	J 320.04	91	J 473.04	61	K 050.13	107
J 214.02	56	J 320.05	91	J 473.05	61	K 050.15	107
J 214.03	56	J 325.01	59	J 474.00	61	K 050.16	107
J 214.04	56	J 325.02	59	J 474.01	61	K 050.17	107
J 220.02	57	J 340.01	59	J 474.02	61	K 050.19	107
J 222.00	57	J 340.02	59	J 474.03	61	K 050.20	107
J 222.01	57	J 340.03	59	J 474.04	61	K 050.21	107
J 230.00	57	J 341.01	59	J 474.05	61	K 050.22	107
J 231.00	57	J 341.02	59	J 475.00	61	K 050.24	107
J 234.00	57	J 341.03	59	J 475.01	61	K 050.25	107
J 234.01	57	J 341.04	59	J 475.02	61	K 050.26	107
J 234.02	57	J 350.00	59	J 475.03	61	K 050.27	107
J 236.00	56	J 350.01	59	J 475.04	61	K 050.28	108
J 236.01	56	J 352.00	57	J 475.05	61	K 050.29	108
J 236.02	56	J 354.00	56	J 476.00	61	K 050.30	108
J 236.03	56	J 355.00	56	J 476.01	61	K 050.32	108
J 236.04	56	J 355.01	56	J 476.02	61	K 050.33	108
J 236.10	56	J 360.00	59	J 476.03	61	K 050.35	108
J 238.00	56	J 360.01	59	J 476.04	61	K 050.36	108
J 238.01	56	J 361.00	59	J 476.05	61	K 050.37	108
J 238.02	56	J 365.00	175	J 478.00	61	K 050.38	108
J 238.03	56	J 368.00	59	J 478.01	61	K 050.39	108
J 238.10	56	J 370.00	57	J 478.02	61	K 050.40	108
J 260.00	58	J 370.01	57	J 478.03	61	K 050.41	108
J 260.01	58	J 370.02	57	J 478.04	61	K 050.42	108
J 260.02	58	J 370.03	57	J 478.05	61	K 050.43	108
J 260.03	58	J 380.01	183	J 602.00	59	K 050.45	108
J 260.04	58	J 381.01	183	J 608.00	56	K 050.46	108
J 260.05	58	J 469.00	61	J 608.01	56	K 050.48	108
J 260.06	58	J 469.01	61	J 608.02	56	K 050.52	108
J 260.07	58	J 469.02	61	J 630.01	192	K 050.53	108
J 260.08	58	J 469.03	61	J 720.00	61	K 054.00	109
J 260.09	58	J 469.04	61	J 721.00	61	K 054.01	109
J 260.10	58	J 469.05	61	J 721.01	61	K 054.02	109
J 260.11	58	J 470.00	61	J 722.00	61	K 054.03	109
J 260.12	58	J 470.01	61	J 722.01	61	K 054.05	109
J 260.13	58	J 470.02	61	J 723.00	61	K 054.07	109
J 260.14	58	J 470.03	61	J 723.01	61	K 054.08	109
J 260.15	58	J 470.04	61	J 725.00	56	K 054.09	109
J 260.16	58	J 470.05	61	J 726.00	56	K 054.10	109
J 263.00	58-190	J 471.00	61	J 727.00	56	K 054.11	109
J 263.01	58-190	J 471.02	61	J 728.00	56	K 054.12	109
J 265.00	58	J 471.03	61			K 054.13	109
J 265.01	58	J 471.04	61			K 054.14	109
J 265.02	58	J 471.05	61			K 054.15	109
J 266.00	58	J 472.00	61	K 050.01	107	K 054.16	109
J 266.01	58	J 472.01	61	K 050.02	107	K 054.17	109
J 300.00	58	J 472.02	61	K 050.03	107	K 054.18	109
J 314.01	59	J 472.03	61	K 050.04	107	K 054.19	109
J 314.02	59	J 472.04	61	K 050.05	107	K 054.20	109
J 317.01	59	J 472.05	61	K 050.07	107	K 054.21	109
J 318.00	59	J 473.00	61	K 050.09	107	K 057.00	100

Kat. No. Cat. No.	Sayfa. Page.	Kat. No. Cat. No.	Sayfa. Page.	Kat. No. Cat. No.	Sayfa. Page.	Kat. No. Cat. No.	Sayfa. Page.
K 057.01	100	K 127.00	62	K 198.00	68	K 350.00	199
K 057.02	100	K 128.00	63	K 200.00	69	K 350.01	199
K 057.03	100	K 133.00	62	K 200.01	69	K 351.00	199
K 057.04	100	K 134.00	62	K 202.00	69	K 352.00	205
K 057.06	100	K 136.00	62	K 202.01	69	K 352.01	205
K 057.07	100	K 137.00	62	K 203.00	69	K 358.00	183
K 057.08	100	K 142.00	62	K 208.00	176	K 402.00	71
K 057.09	100	K 143.00	63	K 210.00	65	K 403.00	71
K 057.10	100	K 143.01	63	K 212.00	65	K 425.00	199
K 057.12	100	K 143.02	63	K 214.00	65	K 425.01	199
K 057.13	100	K 143.03	63	K 215.00	65	K 426.00	199
K 057.15	100	K 145.00	64	K 225.00	126	K 451.01	71
K 057.17	100	K 146.00	63-92	K 230.00	68	K 451.02	71
K 057.18	100	K 147.00	63-92	K 230.01	68	K 451.03	71
K 057.20	100	K 150.00	64	K 230.02	68	K 451.04	71
K 058.00	101	K 151.00	64	K 230.03	68	K 451.05	71
K 058.01	101	K 155.00	176	K 230.04	68	K 451.06	71
K 058.02	101	K 163.00	62	K 230.05	68	K 452.01	71
K 058.03	101	K 164.00	192	K 238.00	64	K 452.02	71
K 058.04	101	K 165.00	192	K 238.01	64	K 452.03	71
K 058.05	101	K 165.01	192	K 238.02	64	K 452.04	71
K 058.06	101	K 166.00	66	K 239.00	199	K 452.05	71
K 058.07	101	K 166.01	66	K 240.00	66	K 457.00	206
K 058.08	101	K 166.02	66	K 241.00	66	K 457.01	206
K 058.10	101	K 167.00	66	K 242.00	66	K 457.02	206
K 058.11	101	K 167.01	66	K 243.00	65	K 457.03	206
K 058.12	101	K 167.02	66	K 260.00	65	K 457.04	206
K 058.16	101	K 168.00	67	K 261.00	65	K 457.05	206
K 060.01	112	K 168.01	67	K 270.00	176	K 458.00	206
K 061.01	110	K 168.03	67	K 271.00	65	K 458.01	206
K 061.02	110	K 169.00	67	K 276.00	69	K 458.02	206
K 061.04	110	K 169.01	67	K 276.01	69	K 458.03	206
K 061.06	110	K 169.02	67	K 290.00	64	K 458.04	206
K 061.07	110	K 169.03	67	K 291.00	64	K 458.05	206
K 061.08	110	K 175.00	62	K 292.00	64	K 459.00	204
K 061.10	110	K 176.00	62	K 295.00	64	K 459.01	204
K 061.11	110	K 177.00	67	K 300.00	70	K 459.02	204
K 062.01	110	K 178.00	67	K 302.00	70	K 462.00	204
K 062.03	110	K 180.00	67	K 310.00	70	K 462.01	204
K 062.05	110	K 180.01	67	K 311.00	70	K 465.00	207
K 100.00	63-92	K 180.02	67	K 315.00	70	K 465.01	207
K 100.01	63-92	K 181.00	67	K 325.00	70	K 465.02	207
K 100.02	63-92	K 181.01	67	K 325.01	70	K 465.03	207
K 100.03	63-92	K 181.02	67	K 325.02	70	K 480.00	71-162
K 101.00	63-92	K 190.00	68	K 325.03	70	K 480.01	71-162
K 101.01	63-92	K 191.00	68	K 327.00	151	K 480.02	71-162
K 101.02	63-92	K 191.01	68	K 336.00	199	K 483.00	69
K 104.00	63	K 191.02	68	K 340.00	199	K 484.00	162
K 120.00	62	K 191.03	68	K 343.00	199	K 485.00	162
K 121.00	62	K 193.00	67	K 346.00	151	K 486.00	162
K 122.00	62	K 193.01	67	K 346.01	151	K 575.00	160
K 123.00	63	K 195.00	68	K 346.02	151	K 575.01	160
K 123.01	63	K 195.01	68	K 347.00	161	K 576.00	160
K 124.01	63	K 195.02	68	K 347.01	161	K 577.00	160
K 125.00	63	K 196.00	68	K 347.02	161	K 578.00	74

Kat. No. Cat. No.	Sayfa. Page.	Kat. No. Cat. No.	Sayfa. Page.	Kat. No. Cat. No.	Sayfa. Page.	Kat. No. Cat. No.	Sayfa. Page.
K 578.01	74	L 152.01	165	L 230.00	169	M 050.16	98
K 578.02	74	L 152.02	165	L 231.00	169	M 050.17	99
K 579.00	160	L 152.03	165	L 232.00	169	M 050.18	99
K 580.00	160	L 155.00	167	L 260.00	122	M 050.19	99
K 580.01	160	L 155.01	167	L 260.01	122	M 050.22	99
K 581.00	160	L 155.02	167	L 263.00	119-124	M 050.24	99
K 583.00	161	L 155.03	167	L 264.00	124	M 050.25	99
K 584.00	161	L 155.04	167	L 266.00	123	M 050.26	99
K 585.00	161	L 158.00	167	L 266.01	123	M 050.27	99
K 586.01	162	L 159.00	166	L 266.02	123	M 050.28	99
K 587.00	163	L 160.00	166	L 268.00	122	M 051.01	99
K 588.00	163	L 161.00	166	L 268.02	122	M 051.04	99
K 589.00	163	L 162.00	166	L 269.00	122	M 051.05	99
K 589.01	163	L 162.01	166	L 270.00	123	M 051.06	99
K 590.00	151	L 165.00	166	L 271.00	123	M 051.08	99
K 595.01	163	L 199.00	164	L 271.01	123	M 051.10	99
K 603.01	204	L 200.00	164	L 271.02	123	M 052.02	100
K 603.02	204	L 201.00	164	L 276.00	125	M 052.04	100
K 671.00	73	L 203.00	164	L 276.01	125	M 054.01	101
K 763.01	72	L 204.00	164	L 276.02	125	M 055.00	101
K 770.00	200	L 205.00	164	L 276.03	125	M 055.01	101
K 771.00	200	L 205.01	164	L 277.00	125	M 055.02	101
K 772.00	201	L 205.02	164	L 277.01	125	M 055.04	101
K 772.01	201	L 205.03	164	L 277.02	125	M 055.05	101
K 773.00	201	L 205.04	164	L 277.03	125	M 056.01	95
K 773.01	201	L 206.00	164	L 280.00	124	M 056.02	95
K 774.00	202	L 207.00	165	L 280.01	124	M 056.03	95
K 775.00	202	L 208.00	165	L 300.00	74	M 056.05	95
K 776.00	203	L 209.00	165	L 304.00	74	M 056.06	95
K 777.00	203	L 223.01	169	L 313.00	74	M 057.00	95
K 778.00	203	L 223.02	169	L 318.00	75	M 057.01	95
K 780.00	73	L 223.03	169	L 320.00	75	M 057.02	95
K 781.00	73	L 223.04	169	L 321.00	75	M 057.05	95
K 783.01	72	L 223.05	169	L 326.00	75	M 058.00	95
K 783.02	72	L 223.06	169	L 330.02	75	M 058.01	95
		L 223.07	169	L 331.02	75	M 060.01	102
		L 225.01	167	L 335.00	75	M 061.01	102
		L 225.02	167	L 336.00	75	M 061.02	102
L 005.00	193	L 225.03	167	L 339.00	75	M 062.01	111
L 005.01	193	L 225.04	167	L 420.00	74	M 062.03	111
L 009.00	193	L 225.05	167	L 420.01	74	M 062.04	111
L 080.00	193	L 226.01	168	L 530.07	88	M 062.05	111
L 081.00	193	L 226.02	168			M 065.01	111
L 082.00	193	L 226.03	168			M 065.02	111
L 083.00	193	L 227.01	169			M 070.01	111
L 085.00	74	L 227.02	169	M 050.00	98	M 071.01	111
L 088.00	74	L 227.03	169	M 050.01	98	M 072.01	112
L 088.01	74	L 228.01	168	M 050.02	98	M 075.01	102
L 089.00	74	L 228.02	168	M 050.05	98	M 075.02	102
L 093.00	74	L 228.03	168	M 050.06	98	M 075.04	102
L 150.01	165	L 229.01	168	M 050.07	98	M 075.05	102
L 150.02	165	L 229.02	168	M 050.08	98	M 080.01	112
L 150.03	165	L 229.03	168	M 050.09	98	M 080.02	112
L 150.04	165	L 229.04	168	M 050.12	98	M 081.01	112
L 152.00	165	L 229.05	168	M 050.15	98	M 100.00	133

Kat. No. Cat. No.	Sayfa. Page.	Kat. No. Cat. No.	Sayfa. Page.	Kat. No. Cat. No.	Sayfa. Page.	Kat. No. Cat. No.	Sayfa. Page.
M 150.01	133	M 291.02	79	M 621.04	80	M 654.05	81
M 151.00	133	M 295.00	198	M 621.05	80	M 654.06	81
M 151.01	133	M 295.01	198	M 629.01	198	M 654.07	81
M 152.01	133	M 310.01	79	M 629.02	198	M 654.08	81
M 153.01	133	M 311.02	79	M 629.03	198	M 656.04	81
M 160.01	133	M 313.01	79	M 629.04	198	M 656.05	81
M 161.01	133	M 330.01	78	M 630.01	136	M 656.06	81
M 162.01	133	M 330.02	78	M 630.02	136	M 656.07	81
M 163.00	134	M 337.01	78	M 630.03	136	M 656.08	81
M 170.01	76-134	M 340.01	78	M 630.04	136	M 658.04	81
M 176.00	76	M 380.00	118	M 630.05	136	M 658.05	81
M 176.01	76	M 380.01	118	M 631.01	136	M 659.01	151
M 190.01	135	M 380.02	118	M 631.02	136	M 681.00	196
M 191.01	135	M 380.03	118	M 631.03	136	M 682.00	196
M 193.01	134	M 380.04	118	M 631.04	136	M 683.03	196
M 194.01	135	M 380.10	118	M 632.01	136	M 702.04	81
M 195.01	134	M 380.15	118	M 633.01	136	M 703.03	81
M 196.01	134	M 400.00	197	M 637.00	80	M 703.04	81
M 197.01	134	M 401.00	197	M 637.01	80	M 703.05	81
M 198.01	134	M 402.00	197	M 638.00	80	M 704.03	81
M 200.01	76	M 402.01	197	M 638.01	80	M 704.04	81
M 201.01	76	M 454.01	196	M 640.01	137	M 704.05	81
M 203.01	76	M 455.01	140	M 640.02	137	M 705.01	81
M 205.02	175	M 457.01	140	M 641.01	137	M 705.02	81
M 205.04	175	M 459.01	196	M 641.02	137	M 705.03	81
M 208.02	175	M 602.01	137	M 642.00	136	M 705.04	81
M 208.04	175	M 603.01	137	M 642.01	136	M 705.05	81
M 213.00	134	M 605.00	136	M 642.02	136	M 706.01	81
M 214.00	77	M 606.00	136	M 644.00	136	M 706.02	81
M 216.00	77	M 608.01	136	M 644.01	136	M 706.03	81
M 216.01	77	M 609.01	137	M 644.02	136	M 706.04	81
M 217.00	77	M 611.00	80	M 644.03	136	M 706.05	81
M 217.01	77	M 611.01	80	M 645.01	136	M 707.03	81
M 217.02	77	M 611.02	80	M 645.02	136	M 751.00	80
M 217.03	77	M 615.01	80	M 645.03	136	M 751.01	80
M 218.00	77	M 615.02	80	M 645.04	136	M 755.00	80
M 219.01	78	M 615.03	80	M 645.05	136	M 755.01	80
M 224.00	77	M 615.04	80	M 645.06	136	M 760.01	197
M 224.01	77	M 615.05	80	M 647.01	137	M 760.02	197
M 224.02	77	M 616.01	80	M 647.02	137	M 760.03	197
M 225.01	135	M 616.02	80	M 647.03	137	M 760.04	197
M 225.02	135	M 616.03	80	M 647.04	137	M 761.01	196
M 227.01	135	M 616.04	80	M 649.00	196	M 761.02	196
M 227.02	135	M 616.05	80	M 649.01	196	M 762.01	72
M 227.03	135	M 617.01	80	M 650.04	81	M 762.02	72
M 232.01	78-135	M 617.02	80	M 650.05	81	M 765.01	72
M 236.01	134	M 617.03	80	M 650.06	81	M 765.02	72
M 236.02	134	M 617.04	80	M 650.07	81	M 765.03	72
M 245.01	78	M 620.01	80	M 650.08	81	M 800.01	82
M 245.02	78	M 620.02	80	M 653.04	81	M 801.00	82
M 250.01	79	M 620.03	80	M 653.05	81	M 802.01	82
M 260.00	79	M 620.04	80	M 653.06	81	M 802.02	82
M 261.00	79	M 621.01	80	M 653.07	81	M 810.01	118
M 274.00	77	M 621.02	80	M 653.08	81	M 811.01	82
M 290.02	79	M 621.03	80	M 654.04	81	M 812.01	82

Kat. No. Cat. No.	Sayfa. Page.	Kat. No. Cat. No.	Sayfa. Page.	Kat. No. Cat. No.	Sayfa. Page.	Kat. No. Cat. No.	Sayfa. Page.
M 815.01	82	N 187.02	150	N 381.01	177	P 166.01	208
		N 187.03	150	N 381.02	177	P 200.00	140
		N 194.01	150	N 381.03	177	P 201.00	141
		N 194.02	150	N 381.04	177	P 201.01	141
N 052.01	96	N 194.03	150	N 382.01	178	P 203.00	141
N 052.02	96	N 195.01	150	N 382.02	178	P 210.00	141
N 052.04	96	N 195.02	150	N 382.03	178	P 265.00	214
N 052.05	96	N 196.01	150	N 382.04	178	P 266.00	214
N 052.06	96	N 196.02	150	N 382.05	178	P 268.00	214
N 052.08	96	N 196.03	150	N 382.06	178	P 270.00	214
N 052.09	96	N 301.01	138	N 383.01	178	P 276.00	214
N 052.12	96	N 303.01	138	N 383.05	178	P 277.00	214
N 052.14	96	N 304.01	138	N 383.02	178	P 278.00	214
N 052.15	96	N 305.00	138	N 383.03	178	P 279.00	215
N 053.01	96	N 308.00	151	N 383.04	178	P 282.00	215
N 054.01	97	N 308.01	151	N 383.06	178	P 285.00	215
N 054.03	97	N 315.01	138	N 384.01	179	P 286.00	215
N 054.05	97	N 316.01	138	N 384.02	179	P 287.00	215
N 054.06	97	N 320.01	139	N 384.03	179	P 297.00	215
N 054.08	97	N 321.01	139	N 384.04	179	P 300.00	216
N 055.00	176	N 322.01	139	N 384.05	179	P 300.01	216
N 055.02	97	N 325.01	138	N 384.06	179	P 302.00	216
N 055.03	97	N 326.01	138	N 385.01	179	P 303.00	216
N 055.04	97	N 328.01	138	N 385.02	179	P 304.01	216
N 055.05	97	N 330.01	139	N 385.03	179	P 350.01	216
N 055.07	97	N 330.02	139	N 386.01	179	P 352.00	216
N 055.08	97	N 330.03	139	N 386.02	179	P 355.00	216
N 056.01	98	N 330.04	139	N 386.03	179	P 366.00	217
N 056.03	98	N 330.05	139			P 367.00	217
N 057.01	98	N 350.00	92			P 368.00	217
N 130.00	83	N 351.00	92			P 400.01	119
N 131.00	83	N 352.00	92	P 050.02	116	P 401.00	119
N 132.00	83	N 352.01	92	P 050.03	116	P 404.01	154
N 133.00	83	N 353.00	92	P 050.04	116	P 405.00	119
N 135.00	83	N 353.01	92	P 050.05	116	P 405.01	119
N 173.00	150	N 353.02	92	P 050.07	116	P 410.00	152
N 174.00	150	N 353.03	92	P 050.08	116	P 412.00	152
N 179.01	83	N 353.04	92	P 050.10	116	P 412.01	152
N 179.02	83	N 354.00	92	P 051.00	116	P 413.00	152
N 179.03	83	N 354.01	92	P 051.01	116	P 413.01	152
N 179.04	83	N 354.02	92	P 051.03	116	P 415.00	153
N 179.05	83	N 354.03	92	P 051.04	116	P 460.00	154
N 179.06	83	N 354.04	92	P 051.06	116	P 464.00	154
N 179.07	83	N 370.00	150	P 051.08	116	P 464.02	154
N 179.08	83	N 370.01	150	P 051.10	116	P 502.01	217
N 179.09	83	N 370.02	150	P 051.11	116	P 580.00	140
N 179.10	83	N 370.03	150	P 125.00	141	P 581.00	140
N 180.01	83	N 370.05	150	P 151.00	141	P 585.01	140
N 180.02	83	N 372.01	151	P 164.00	209	P 585.02	140
N 186.01	83	N 380.00	177	P 164.01	209	P 611.00	210
N 186.02	83	N 380.01	177	P 164.02	209	P 612.00	219
N 186.03	83	N 380.02	177	P 165.00	209	P 613.00	219
N 186.04	83	N 380.03	177	P 165.01	209	P 614.00	219
N 186.05	83	N 380.04	177	P 165.02	209	P 615.00	219
N 187.01	150	N 380.05	177	P 166.00	208	P 616.00	219

Kat. No. Cat. No.	Sayfa. Page.	Kat. No. Cat. No.	Sayfa. Page.	Kat. No. Cat. No.	Sayfa. Page.	Kat. No. Cat. No.	Sayfa. Page.
P 617.00	210	R 053.07	115	R 251.02	184	R 370.00	156
P 618.01	220	R 053.09	115	R 251.03	184	R 370.01	156
P 618.02	220	R 053.10	115	R 260.00	94	R 370.02	156
P 618.03	220	R 053.12	115	R 270.00	181	R 460.00	154
P 618.05	220	R 053.15	115	R 270.01	181	R 461.01	154
P 632.00	219	R 053.16	115	R 272.00	181	R 462.01	154
P 634.00	219	R 053.17	115	R 280.00	180	R 463.01	155
P 635.00	219	R 053.18	115	R 280.01	180	R 463.02	155
P 640.00	220	R 053.19	115	R 280.02	180	R 463.03	155
P 641.00	220	R 202.00	185	R 315.00	94	R 464.01	155
P 643.00	220	R 204.00	185	R 317.01	94	R 464.02	155
		R 210.00	185	R 320.00	142	R 465.01	155
		R 210.01	185	R 322.00	142	R 465.02	155
		R 210.02	185	R 324.00	142	R 466.01	155
R 052.01	113	R 210.03	185	R 325.00	142	R 467.01	155
R 052.02	113	R 210.04	185	R 327.00	142	R 467.02	155
R 052.03	113	R 210.05	185	R 328.01	144	R 467.03	155
R 052.04	113	R 210.06	185	R 328.02	144	R 468.01	155
R 052.05	113	R 210.11	185	R 328.03	144	R 470.01	157
R 052.10	113	R 212.00	185	R 328.04	144	R 470.02	157
R 052.11	113	R 215.00	185	R 330.00	144	R 471.01	157
R 052.13	113	R 215.01	185	R 331.01	144	R 471.02	157
R 052.14	113	R 215.02	185	R 331.02	144	R 472.00	157
R 052.16	113	R 219.00	143	R 340.00	143	R 473.00	157
R 052.18	113	R 220.00	89	R 341.01	145	R 762.01	187
R 052.19	113	R 221.00	89	R 341.02	145	R 762.02	187
R 052.20	113	R 224.00	94	R 341.03	145	R 762.03	187
R 052.22	113	R 224.01	94	R 342.01	145	R 762.04	187
R 052.23	113	R 225.00	94	R 343.01	146-156	R 762.05	187
R 052.24	113	R 226.01	94	R 343.02	146-156	R 762.06	187
R 052.25	113	R 226.02	94	R 343.03	146-156	R 763.01	187
R 052.26	114	R 226.03	94	R 344.01	146-156	R 763.02	187
R 052.27	114	R 227.00	94	R 345.00	143	R 770.00	186
R 052.28	114	R 227.01	94	R 346.00	143	R 770.01	186
R 052.30	114	R 227.02	94	R 346.01	143	R 771.01	186
R 052.31	114	R 228.00	94	R 347.00	143	R 772.00	186
R 052.33	114	R 229.00	94	R 347.01	143	R 773.01	186
R 052.34	114	R 230.00	191	R 347.02	143	R 774.00	186
R 052.36	114	R 230.01	191	R 347.03	143	R 775.01	186
R 052.37	114	R 230.02	191	R 347.04	181	R 776.01	153
R 052.38	114	R 231.00	191	R 347.05	181	R 776.02	153
R 052.39	114	R 231.01	190	R 348.00	143	R 777.00	186
R 052.40	114	R 231.02	190	R 349.00	143	R 778.00	186
R 052.41	114	R 232.00	191	R 349.01	143-180	R 778.01	186
R 052.43	114	R 232.01	191	R 360.00	145-155	R 779.01	186
R 052.44	114	R 232.02	191	R 360.01	145-155	R 782.01	186
R 052.45	114	R 233.00	191	R 360.02	145-155	R 783.01	153
R 052.46	114	R 233.01	191	R 360.03	145-155	R 783.02	153
R 052.47	114	R 233.02	191	R 360.04	145-155	R 784.01	186
R 052.48	114	R 234.02	191	R 362.00	145-155	R 785.01	186
R 053.00	115	R 235.00	180	R 362.01	145-155	R 786.01	186
R 053.01	115	R 235.02	191	R 362.02	145-155	R 787.01	186
R 053.03	115	R 250.00	184	R 365.00	146	R 788.01	186
R 053.04	115	R 251.00	184	R 365.01	156	R 789.01	186
R 053.06	115	R 251.01	184	R 366.00	146	R 789.02	186

Kat. No. Cat. No.	Sayfa. Page.	Kat. No. Cat. No.	Sayfa. Page.	Kat. No. Cat. No.	Sayfa. Page.	Kat. No. Cat. No.	Sayfa. Page.
R 789.03	186	T 200.00	118	Z 012.00	225		
R 795.00	153-187	T 201.00	118	Z 015.00	225		
R 796.00	153-187	T 202.00	118	Z 015.01	225		
R 830.02	190	T 462.00	147	Z 015.02	225		
R 830.05	190	T 600.00	147	Z 016.00	225		
R 831.02	190	T 747.00	211	Z 016.01	225		
R 831.05	190			Z 016.02	225		
R 832.02	190			Z 060.00	225		
R 832.05	190			Z 065.00	225		
R 833.02	190	V 050.00	112	Z 095.00	225		
R 833.05	190	V 050.01	112	Z 096.00	225		
		V 052.00	106	Z 097.00	225		
		V 052.01	106	Z 100.00	222		
		V 052.02	106	Z 120.00	222		
S 010.00	46	V 052.04	106	Z 121.00	222		
S 011.00	46	V 052.05	106	Z 150.00	222		
S 012.00	46	V 053.01	112	Z 150.01	222		
S 013.00	46	V 053.02	112	Z 150.03	222		
S 014.00	46	V 606.00	221	Z 151.01	222		
S 015.00	46	V 608.00	221	Z 151.03	222		
S 020.00	46	V 611.00	211	Z 160.08	223		
S 021.00	46	V 611.01	211	Z 160.09	223		
S 022.00	46	V 611.02	211	Z 160.10	223		
S 023.00	46	V 615.00	221	Z 160.11	223		
S 024.00	46	V 630.00	221	Z 160.12	223		
S 025.00	46	V 630.01	221	Z 160.13	223		
S 026.00	46	V 631.00	221	Z 160.14	223		
S 030.00	46	V 632.00	221	Z 160.15	223		
S 530.05	88	V 633.00	221	Z 160.16	223		
S 530.09	88	V 633.01	221	Z 160.17	223		
S 530.10	88	V 635.00	221	Z 160.18	223		
S 532.00	88	V 636.00	221	Z 160.19	223		
		V 639.00	74	Z 160.20	223		
		V 646.00	211	Z 160.21	223		
		V 750.00	211	Z 160.22	223		
T 040.01	192	V 750.03	211	Z 160.23	223		
T 041.01	192	V 754.00	211	Z 170.01	223		
T 042.01	192	V 754.04	211	Z 170.04	223		
T 050.01	106	V 754.05	211	Z 170.07	223		
T 050.02	106	V 754.06	211	Z 171.01	223		
T 050.03	106	V 765.00	147	Z 172.01	223		
T 050.05	106	V 765.01	147	Z 180.00	222		
T 050.06	106	V 765.02	147	Z 180.01	222		
T 050.07	106	V 766.00	147	Z 180.02	222		
T 051.01	106			Z 188.00	224		
T 051.02	106			Z 190.00	224		
T 052.01	106						
T 060.00	176	Z 001.00	225				
T 070.00	189	Z 002.00	225				
T 070.01	189	Z 003.00	225				
T 070.02	189	Z 004.00	225				
T 070.03	189	Z 005.00	225				
T 070.04	189	Z 006.00	225				
T 070.05	189	Z 009.00	225				
T 070.06	189	Z 010.00	225				

NOT : _____



BAHADIR A.Ş.
Organize Sanayi Bölgesi
55300 SAMSUN
Location 41.2389, 36.4277
Tel: 0362 266 70 00
Fax: 0362 266 70 05

www.bahadir.com.tr
info@bahadir.com.tr

