

Kalp Damar ve Göğüs Cerrahi
Cardiovascular and Thoracic Surgery

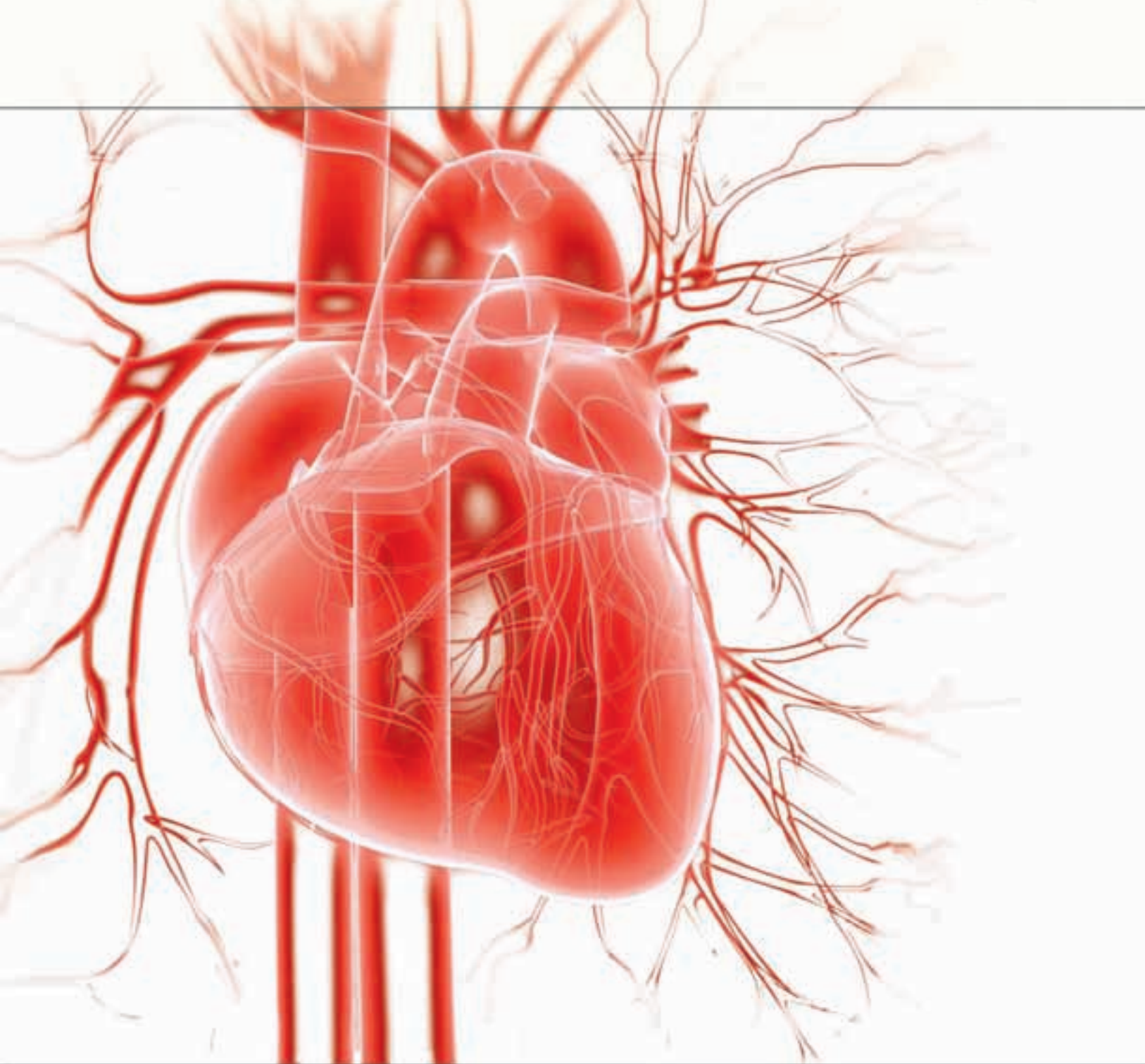

 **BAHADIR®**



KALP DAMAR VE GÖĞÜS CERRAHI
CARDIOVASCULAR AND THORACIC SURGERY

BAHADIR TIBBİ ALETLER SANAYİ VE TİCARET A.Ş.
BAHADIR MEDICAL EQUIPMENT INDUSTRY AND TRADE CO.
Organize Sanayi 55300 SAMSUN / TURKEY
Tel: +90362 266 70 00 (Pbx) Fax: +90362 266 70 05
www.bahadir.com.tr info@bahadir.com.tr



BAHADIR, sağlık sektöründe hizmet veren tecrübeli bir aile şirkettir. 1985 yılında kurulmuş olan firma Türkiye'nin önde gelen cerrahi alet üreticilerinden birisidir. Üretim ISO 9001-2000 ve ISO 13485:2003 Kalite Yönetim Sistemlerine uygun olarak gerçekleştirilir. Ana üretim alanlarımız, sağlık kurumlarının bütün branşları için medikal aletler, steril konveyer sistemleri, hastane terlikleri ve masa üstü buhar sterilizatörüdür. Diğer ürünler için üretim ve geliştirme çalışmaları yapılmaktadır. Ürünlerin büyük bir bölümü ihraç edilmektedir. BAHADIR, geçmişin tecrübesini, ileri teknolojilerle birleştirerek, siz değerli müşterilerine, kalite, bekersiz servis hizmeti ve ulaşılanız güvenli sağlamak konusunda daima önde olma çabası içerisinde. Misyonumuz, bilgi ve tecrübeyi, çok çalışma ve azimle birleştirerek sürekli gelişen dünyada lider ve kalıcı olabilmektir. Bizi ne zaman isterseniz ziyaret edebilirsiniz. Sizleri aramızda görmekten memnuniyet duyuyoruz.

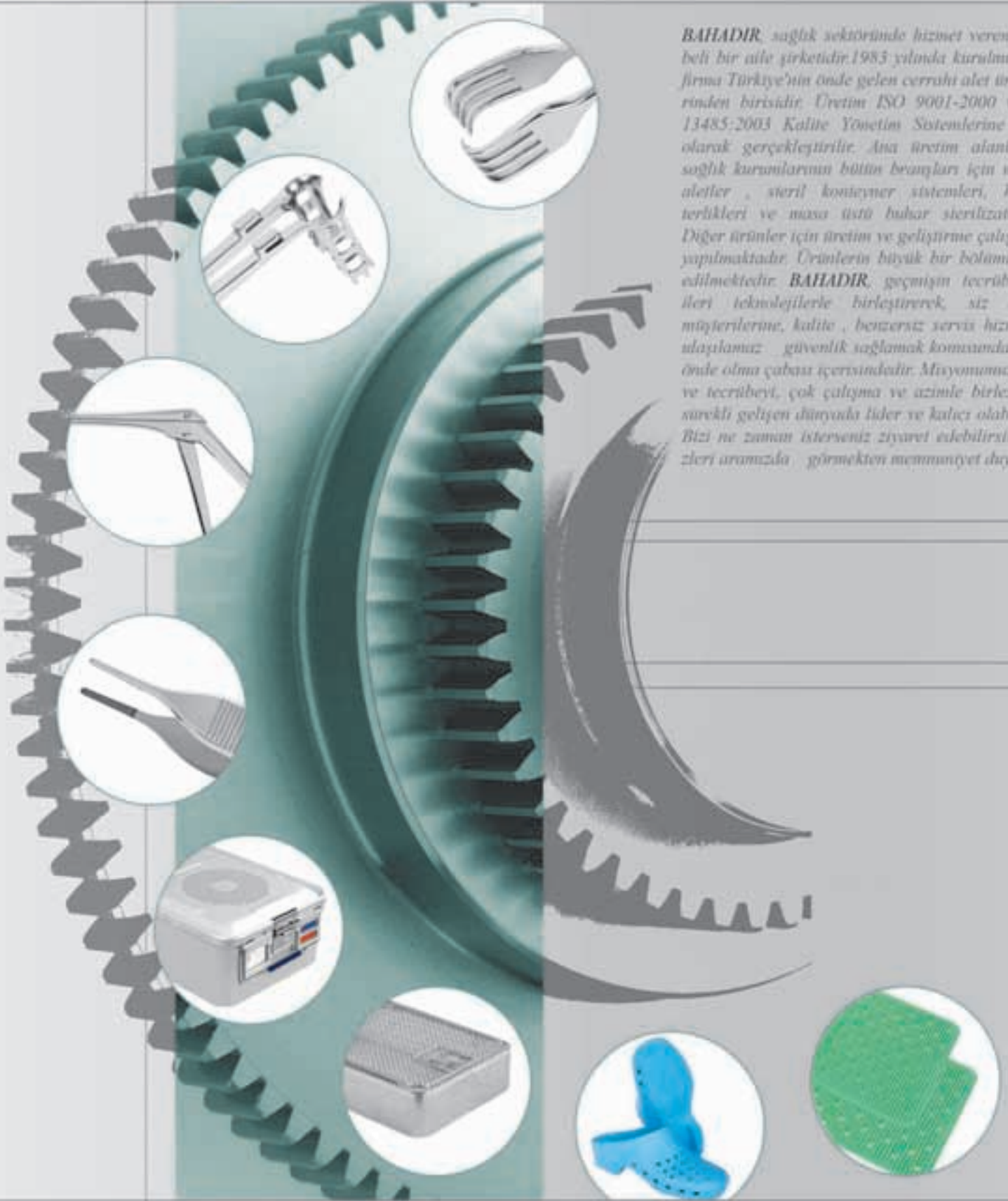



Bahadır is an experienced family company serving in healthcare sector for more than twenty years. It is one of the leading manufacturer of surgical instruments in Turkey established in 1983. The production is run in compliance with ISO-9001:2000 and ISO 13485:2003 Quality Management System. Our main production fields are medical instruments for all branches in hospitals and schools of medicine, sterile container systems, hospital clogs and bench top steam sterilizers. The production and development studies for other products are carried out. A great number of our products are exported. BAHADIR strives to be at the forefront by adding past experiences to those of advancing technologies and bring you, our valued customer, the highest quality, unmatched service and unsurpassed reliability. Our mission is to combine knowledge and experience with hardwork and enthusiasm to be able to contribute consistently improving world of science. You can visit us whenever you want. We would be happy to see you among us.





BAHADIR

BAHADIR, cerrahi aletlerin dövme malzemelerini temsilcisi olduğu firmalardan almaktadır. Müşterilerden gelen siparişler doğrultusunda bu malzemeler firmamızda işlenerek nihayi ürün haline getirilir. Üretimde klasik makinelerin yanısıra modern üretim makineleri de kullanılmaktadır.

Klasik cerrahi başlığı altında bulunan ürünlerimiz tıp fakülteleri ve hastanelerin cerrahi branşlarının ihtiyaçlarını karşılayabilecek çeşitliliğe sahiptir. Teşislerimizde, genel cerrahi, ortopedik cerrahi, beyin cerrahi, KBB, kalp cerrahi, üroloji, mikro cerrahi, jinekoloji ve plastik cerrahi için cerrahi aletler üretilmektedir.

Bütün branşlar için üretilen cerrahi alet ve aparatlar klasik ve modern cerrahi tekniklere uygun olarak üretilmektedir. Yüksek kalite için Alman paslanmaz çelik ham malzeme kullanılmaktadır.



The raw forged materials of the medical instruments are bought from the companies whose representative is BAHADIR. They are converted into a final product after being processed in our company according to the orders from our customers. Besides the modern production machinery, the classical machinery is also used in production.

Our products under the title of classical surgery are rich enough to meet the needs of the surgical branches in schools of medicine and hospitals. Medical Instruments for general surgery, orthopedic surgery, brain surgery, ENT, cardio-vascular surgery, urology, micro surgery, gynaecology, plastic and reconstructive surgery are produced in our facilities.

The surgical hand instruments and apparatus are produced in accordance with the classical and modern surgical techniques for all branches. German stainless steel raw material is used for high quality.





BAHADIR markası ile tedarik edilen ürünler, işçilik ve malzeme hatalarına karşı garantilidir. Garanti periyodu içerisinde hatalı malzemeler yenileri ile değiştirilir. Garanti kapsamı dışında kalan aletlerin de bakımı ve onarımı yapılmaktadır. Bu hizmet sadece kendi ürünlerimiz için sınırlandırılmamıştır.

The products under BAHADIR brand are guaranteed for the defects stemming from workmanship and material. Within the guarantee period, the defected material is replaced with a new one. Maintenance and repair service of the instruments also be given to the items that are out of guarantee. This service is not bounded to our products only .





Katalogdaki resimler, ölçüler ve detaylar bilgi verilmeksizin deęiştirilebilir.

We, may change pictures, dimensions and details in this catalog without notice.

Katalogda bulduęunuz yanlışlıkları, eksiklikleri ve katalog hakkındaki önerilerinizi bildirmenizi önemle rica ederiz.

We kindly ask you to inform us about mistakes, lack of information you may find in this catalog and your comments please.

Her hakkı saklıdır. Bu katalogun hiçbir bölümü BAHADIR 'ın yazılı izni olmadan kopya edilemez, yayınlanamaz.

All rights reserved. No part of this catalog may be reproduced in any form without written permission from BAHADIR

INSTRUMENTS





B 030.00
12 cm
No. 3



B 030.01
12.5 cm
No. 3



B 032.00
16 cm
No. 7



B 030.02
21 cm
No. 3 L



B 034.00
22.5 cm
No. 3



B 034.01
22.5 cm
No. 3



B 040.00
13.5 cm
No. 4



B 040.01
13.5 cm
No. 4



B 040.02
21.5 cm
No. 4 L



B 043.00
22.5 cm
No. 4



B 043.01
22.5 cm
No. 4



Yuvarlak Saplar

- Parmaklar arasında istenildiği şekilde döndürmeye izin verir.
- Sağlam veya oyulmuş saplardan dolayı her bir alette optimum denge sağlar

Round Handle

- Allows rotation between the fingers as required
- Due to carved and strong handle, each instrument provides optimum balance

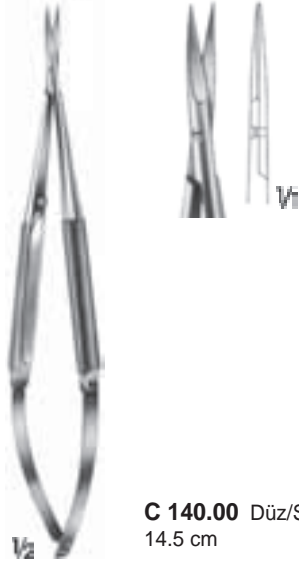

C 140.00 Düz/Straight
14.5 cm



C 141.00 Eğri/Curved
14.5 cm



C 142.00 Eğri/Curved
Mikro Diseksiyon Makası
Micro Dissecting Scissors
14.5 cm

Düz Saplar ve çapraz tırtıllı :
Sağlam kavrama özelliği sağlar.

Flat handles and cross serration:
Provides a solid grip.

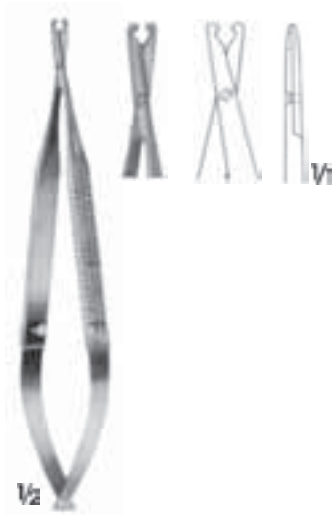

BIEMER
C 110.00
Damar ucunu pürüzsüzleştirmek
için damar makası/
Vein Scissors for roughening ves-
sel ends
13 cm



C 112.00 - C 113.00
16cm

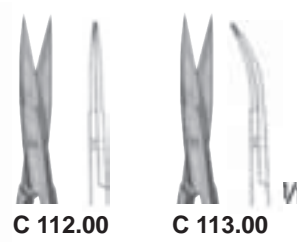

C 112.00

C 113.00

V1



VANNAS
C 116.00 - C 117.00
16cm

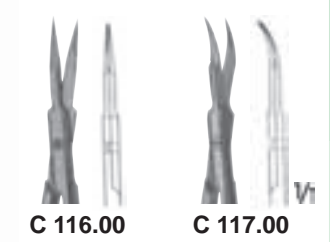

C 116.00

C 117.00

V1

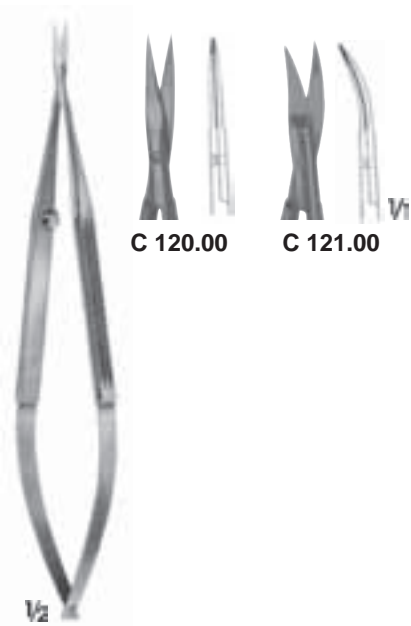

MILLESİ
C 120.00 - C 121.00
Çift ağızlı tırtıllı
Both jaws serrated
16 cm



C 124.00 - C 125.00
18.5 cm

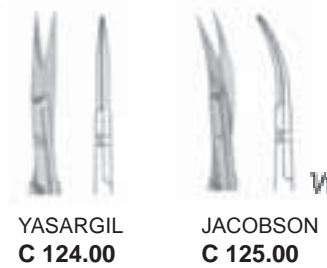

YASARGIL
C 124.00

JACOBSON
C 125.00

V1



POTTS-YASARGIL
C 126.00
18.5 cm

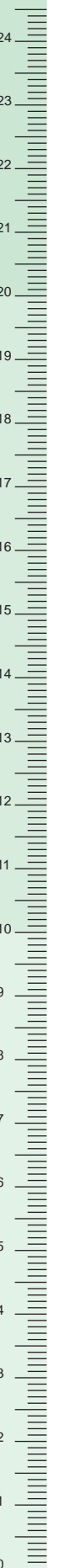



Hafif Plastik Saplı Mikro Makaslar(Yaylı Tip) Micro Scissors (Spring Type) with Light Plastic Handle

Kavrama yüzeyini artıran hafif plastik tutamak :

- Kramp oluşturmeyen, doğal tutma pozisyonu ve duyarlılık sağlar.
- Yuvarlak tutma kesiti aletin kolay ve düzgün rotasyonunu sağlar. Böylelikle uygulama ve çalışma alanı genişler.
- Pimli tutma profili güvenli tutmayı garanti eder.
- Ergonomik, hafif plastik sap yorulmadan optimum kullanım sağlar.

Lightweigh plastic handles to increase grip surface:

- Provides cramp free, natural holding positions and sensitivity
- Round cross-section of the instrument provides an easy and smooth rotation. Expands the working and application area.
- Retention profile with pin ensures safe griping.
- Ergonomic, light weight plastic handle provides fatigue free, optimal usage.

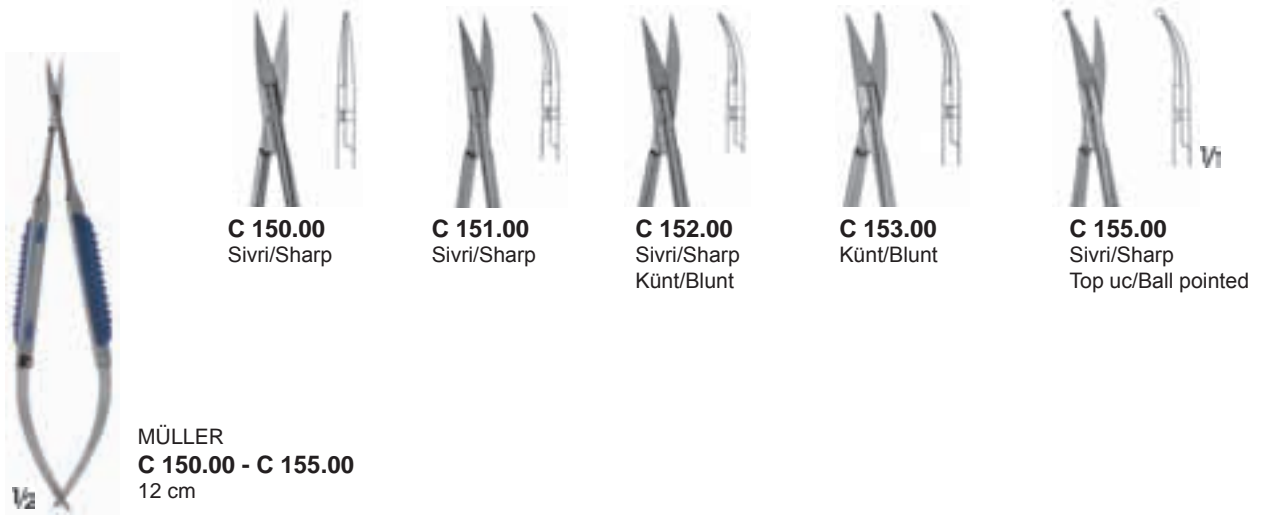

Düz Sap
Flat Handle

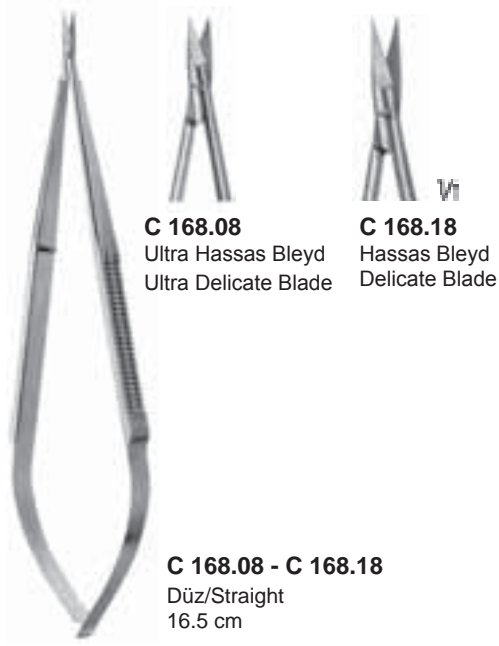

Yuvarlak Sap
Round Handle

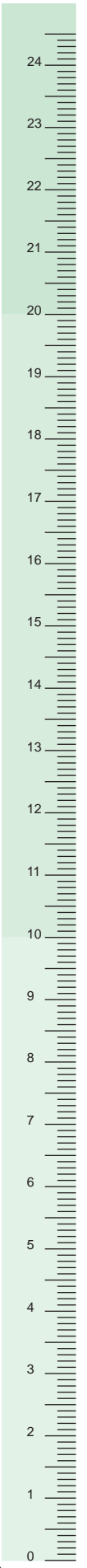

Düz Sap
Flat Handle

Ince Bleyd
Fine Blade

25°

45°

60°

90°

125°



C 168.50



C 168.51



C 168.53



C 168.54



C 168.56

Hassas Bleyd, tek tarafı küre uçlu bleyd
Delicate Blade, with 1 probe pointed blade



C 168.30



C 168.31



C 168.33



C 168.34



C 168.36

Hassas Bleyd
Delicate Blade



C 168.10



C 168.11



C 168.13



C 168.14



C 168.16

Ultra Hassas Bleyd
Ultra Delicate Blade



C 168.00



C 168.01



C 168.03



C 168.04



C 168.06



C 168.00 - C 168.56
16.5 cm

Yuvarlak Sap
Round Handle

Ince Bleyd
Fine Blade

25°

45°

60°

90°

125°



C 169.50



C 169.51



C 169.53



C 169.54



C 169.56

Hassas Bleyd, tek tarafı küre uçlu bleyd
Delicate Blade, with one probe pointed blade



C 169.30



C 169.31



C 169.33



C 169.34



C 169.36

Hassas Bleyd
Delicate Blade



C 169.10



C 169.11



C 169.13



C 169.14



C 169.16

Ultra Hassas Bleyd
Ultra Delicate Blade



C 169.00



C 169.01



C 169.03



C 169.04



C 169.06



W

C 169.00 - C 169.56
16.5 cm

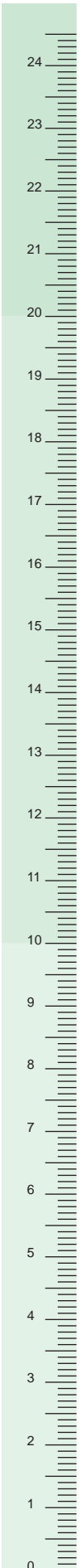



Düz Saplı Mikro Makaslar(Yaylı Tip)
Flat Handle Micro Scissors(Spring Type)

Düz Sap
Flat Handle



C 134.00 - C 134.06
18.5 cm



C 134.00
25°



C 134.01
45°



C 134.03
60°



C 134.04
90°



C 134.06
125°



C 135.00 - C 135.06
18.5 cm



C 135.00
25°



C 135.01
45°



C 135.03
60°



C 135.04
90°



C 135.06
125°



Sivri/Sharp
1 bleyd tırtıllı/1 Blade serrated

Sütür 6-0 ve daha küçükler için - 8-0 ve daha küçükler için
For sutures 6-0 and smaller - 8-0 suture and smaller

C 149.00
Mikro Dikiş Makası
Micro Ligature Scissors
18 cm

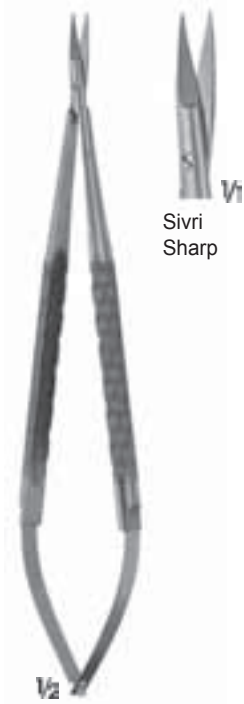

Sivri
Sharp

C 146.00
Mikro Makas/Micro Scissors
18 cm



Sivri
Sharp

C 147.00
Mikro Makas/Micro Scissors
18 cm

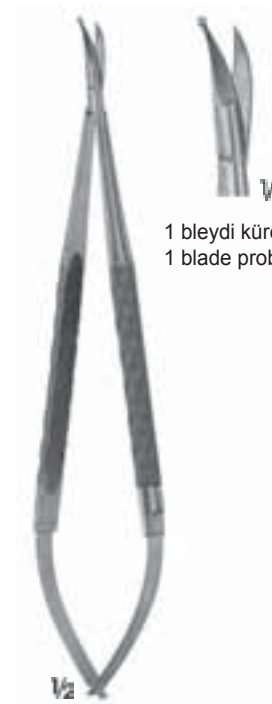

1 bleydi küre uclu
1 blade probe pointed

C 148.00
Mikro Makas/Micro Scissors
18 cm

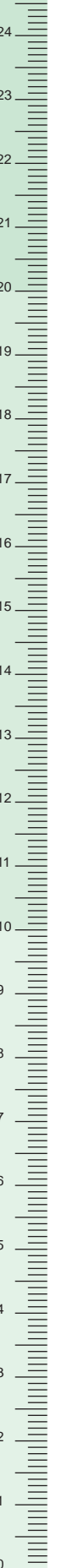

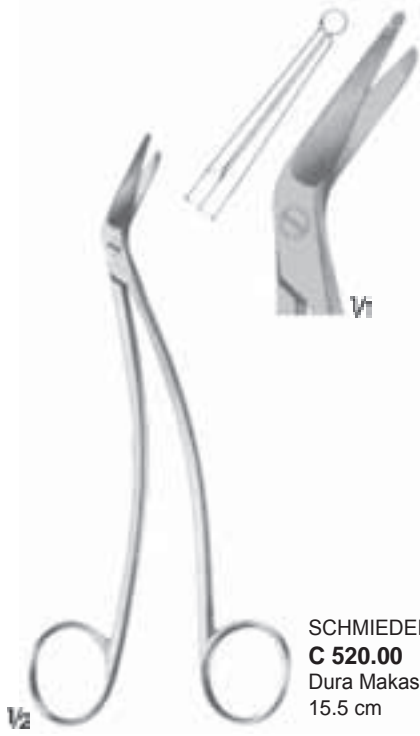

SCHMIEDEN-TAYLOR
C 520.00
Dura Makası/Dura Scissors
15.5 cm

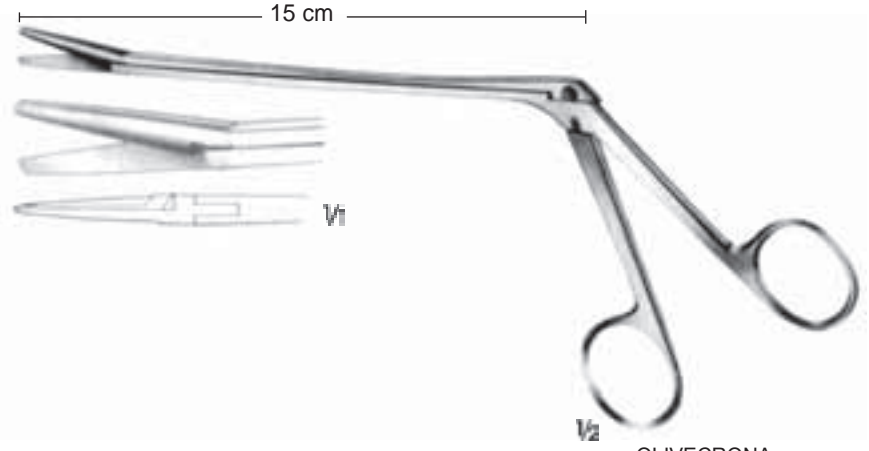

OLIVECRONA
C 530.00 Düz/Straight
Dura Makası/Dura Scissors

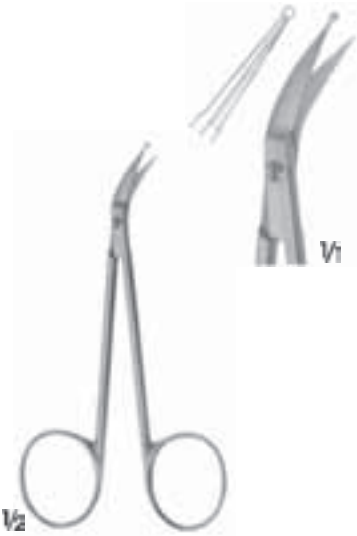

PERWITZSCHKY
C 522.00
1 bleydi küre uclu, yana eğri
With 1 probe pointed blade, curved to side
Hassas Makas/Delicate Scissors
10 cm



C 523.00
Yana doğru açılı/Angled to side
Hassas Makas/Delicate Scissors
11.5 cm



C 540.00
1 bleydi küre uclu eğri makas
With 1 probe pointed blade
Hassas Makas/Delicate Scissors
12 cm

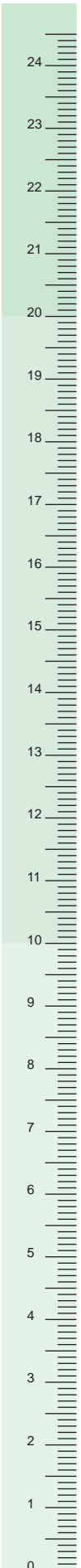
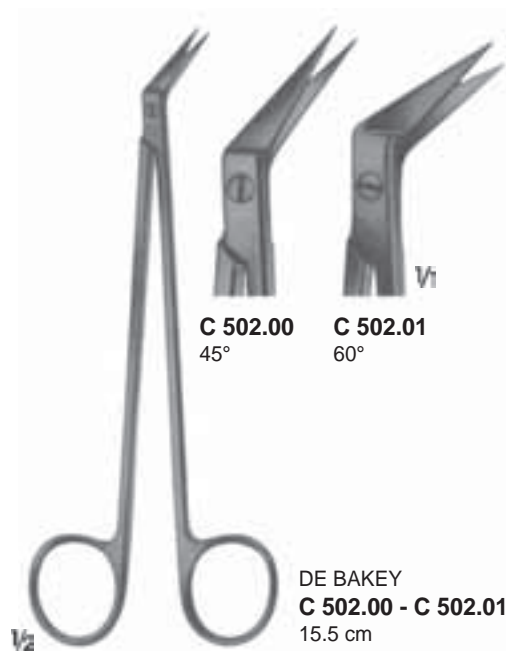
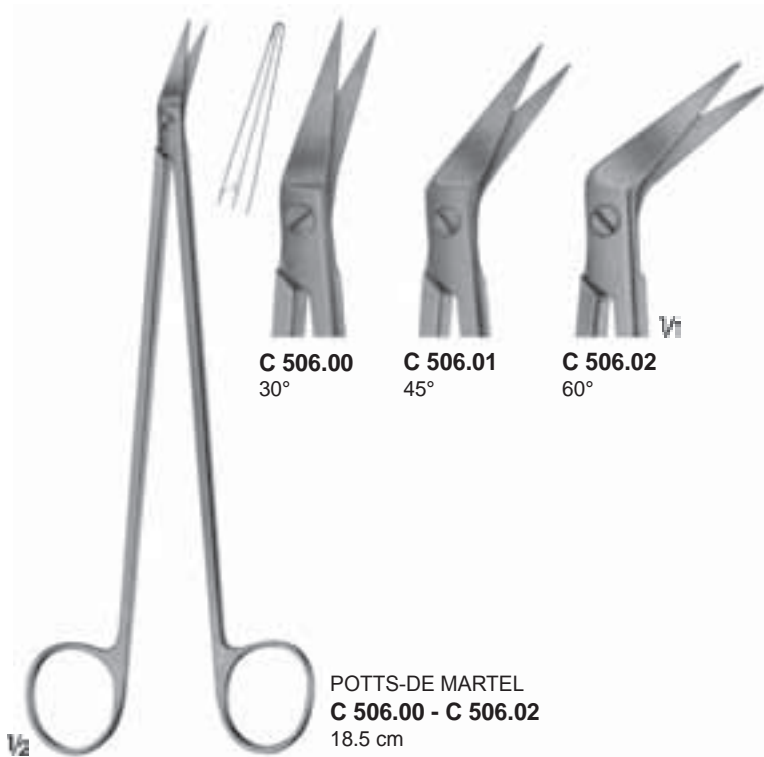
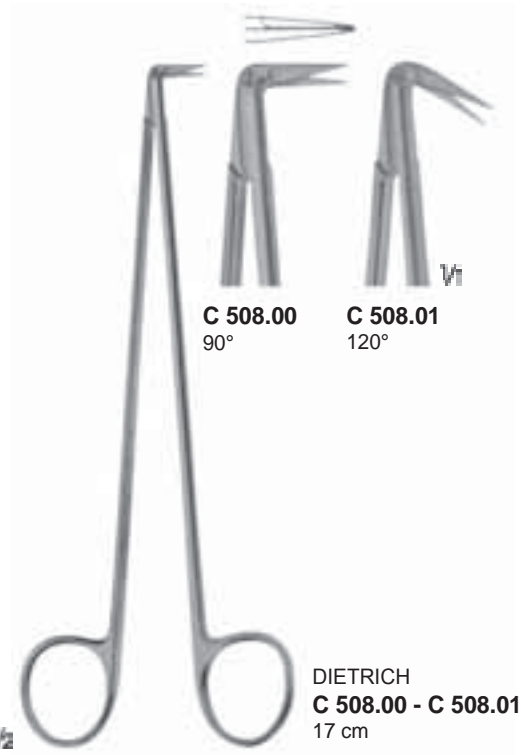
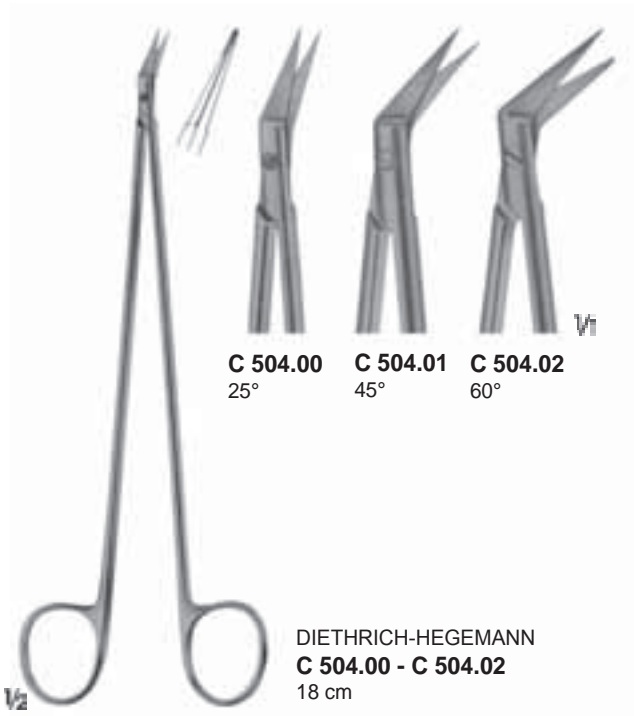

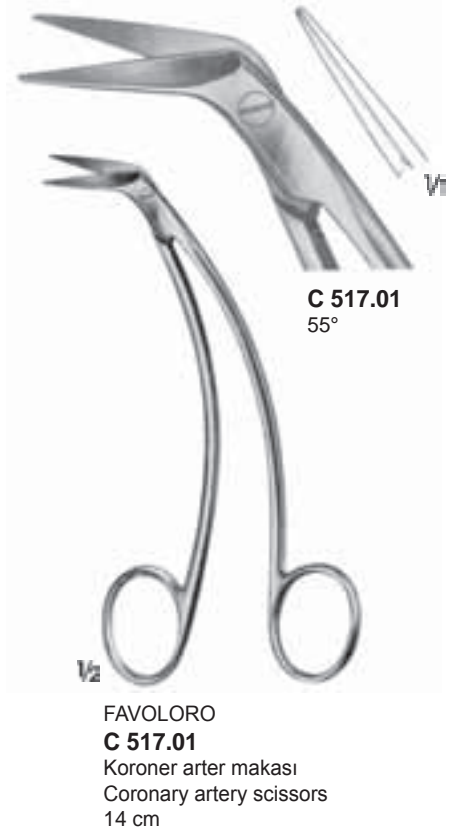
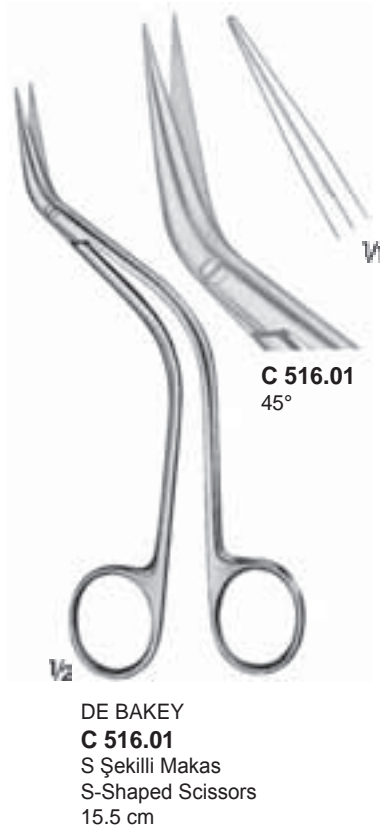
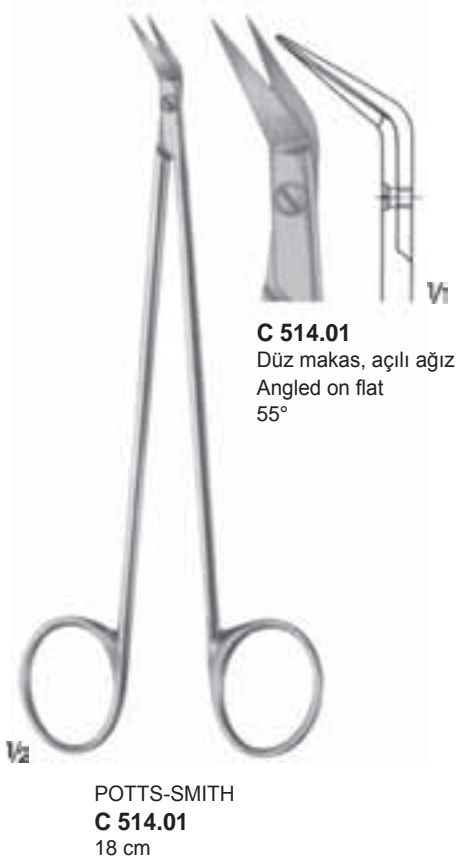
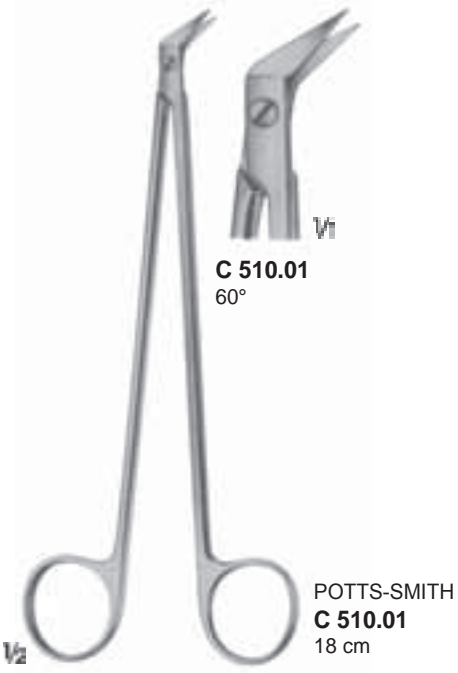



DE MARTEL
C 515.00 - C 515.01
18 cm



DIETRICH
C 519.00
17 cm

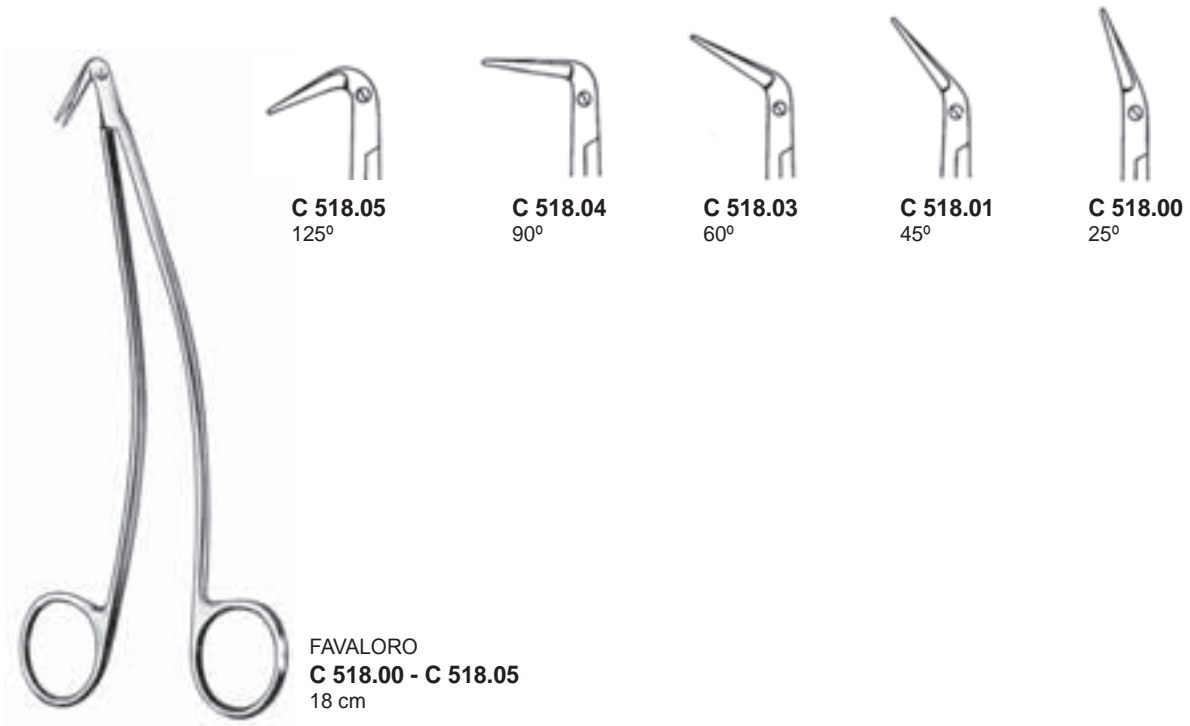

FAVALORO
C 518.00 - C 518.05
18 cm

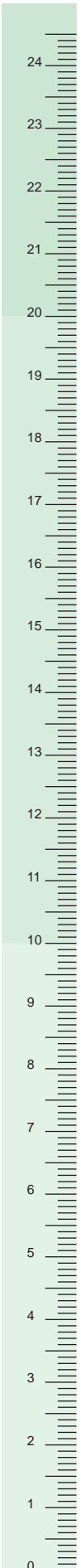

Standart Bleyd
Standard Blade

25°



C 513.30

45°



C 513.31

60°



C 513.33

90°



C 513.34

125°



C 513.35

Hassas Bleyd
Delicate Blade



C 513.10



C 513.11



C 513.13



C 513.14



C 513.15

Ultra Hassa Bleyd
Ultra Delicate Blade



C 513.00



C 513.01



C 513.03



C 513.04



C 513.05

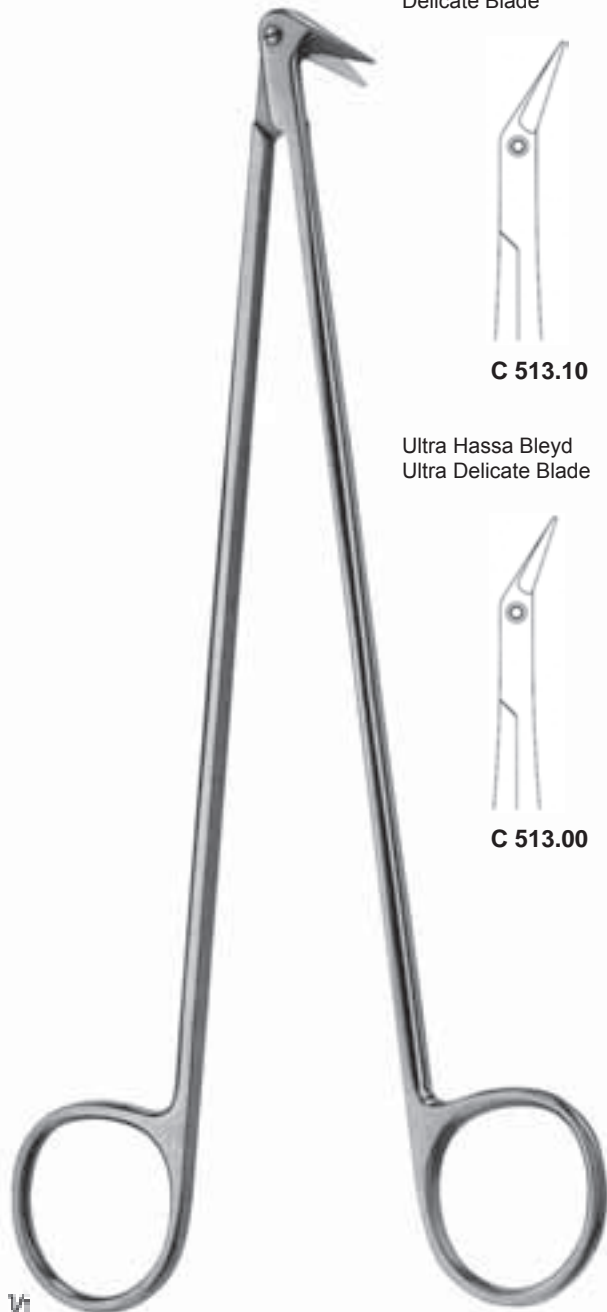

DIETRICH-POTTS
C 513.00 - C 513.35
18 cm

- Cerraha maksimum ergonomik rahatlık sağlar.
- Optimize tasarımları sayesinde zor suture ve anastomoz tekniklerinde yorulmadan çalışmayı sağlar.
- Provides maximum ergonomic comfort to surgeon.
- Due to optimized design, it provides fatigue free working on suture and anastomosis techniques.



REIN-KUPKA
C 547.00
Diseksiyon Makası/Dissecting Scissors
19.5 cm



HELLBERG-KUPKA
C 548.00 Sivri/Sharp
Mikro Makas/Micro Scissors
21 cm

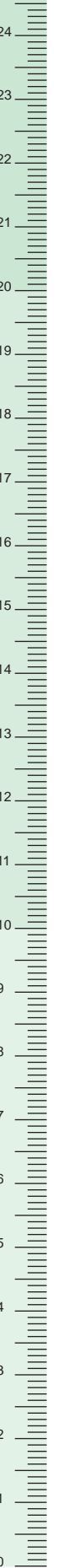



JAMESON-WERDER
C 385.00 Eğri/Curved
Diseksiyon Makası/Dissecting Scissors
13 cm



JAMESON
C 386.00 Eğri/Curved
Diseksiyon Makası/Dissecting Scissors
15 cm

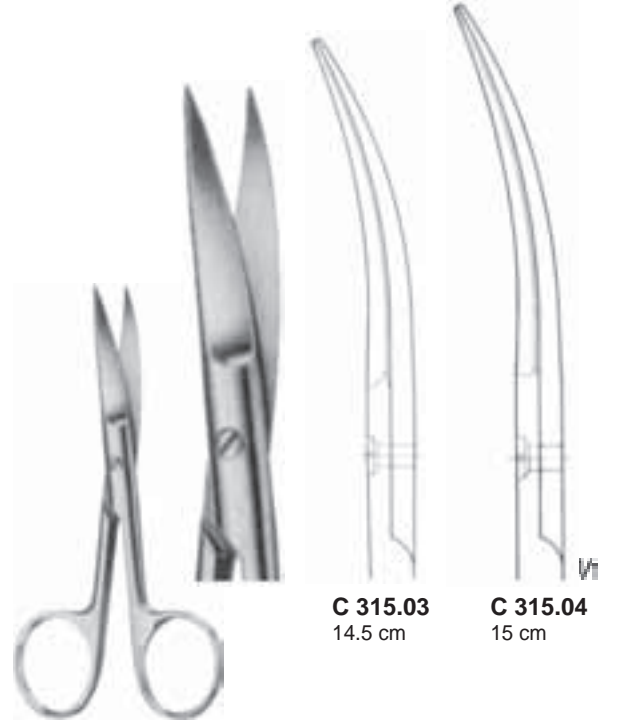

C 315.03- C 315.04
Cerrahi Makaslar/Surgical Scissors
Standart Model/Standart Patterns
Sivri/Sharp, Eğri/Curved

C 315.03
14.5 cm

C 315.04
15 cm



JOSEPH
C 250.00 - C 251.00
Hassas Makaslar/Delicate Scissors
15 cm

C 250.00
Düz/Straight
Sivri/Sharp

C 251.00
Eğri/Curved
Sivri/Sharp



KELY
C 252.00 - C 253.00
Hassas Makaslar/Delicate Scissors
17.5 cm

C 252.00
Düz/Straight
Sivri/Sharp

C 253.00
Eğri/Curved
Sivri/Sharp



C 310.03 14.5 cm
C 310.04 15 cm
C 310.05 16.5 cm

C 310.03-C 310.05
Standart Model/Standart Patterns
Sivri-Künt/Sharp-Blunt



C 314.03 14.5 cm
C 314.04 15 cm
C 314.05 16.5 cm

C 314.03 - C 314.05
Standart Model/Standart Patterns
Sivri/Sharp



C 311.03 14.5 cm
C 311.04 15 cm
C 311.05 16.5 cm

C 311.03-C 311.05
Standart Model/Standart Patterns
Sivri-Künt/Sharp-Blunt



C 313.03 14.5 cm
C 313.04 15 cm
C 313.05 16.5 cm

COOPER
C 313.03 - C 313.05
Standart Model/Standart Patterns
Künt/Blunt

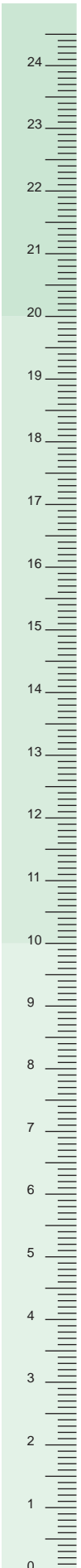

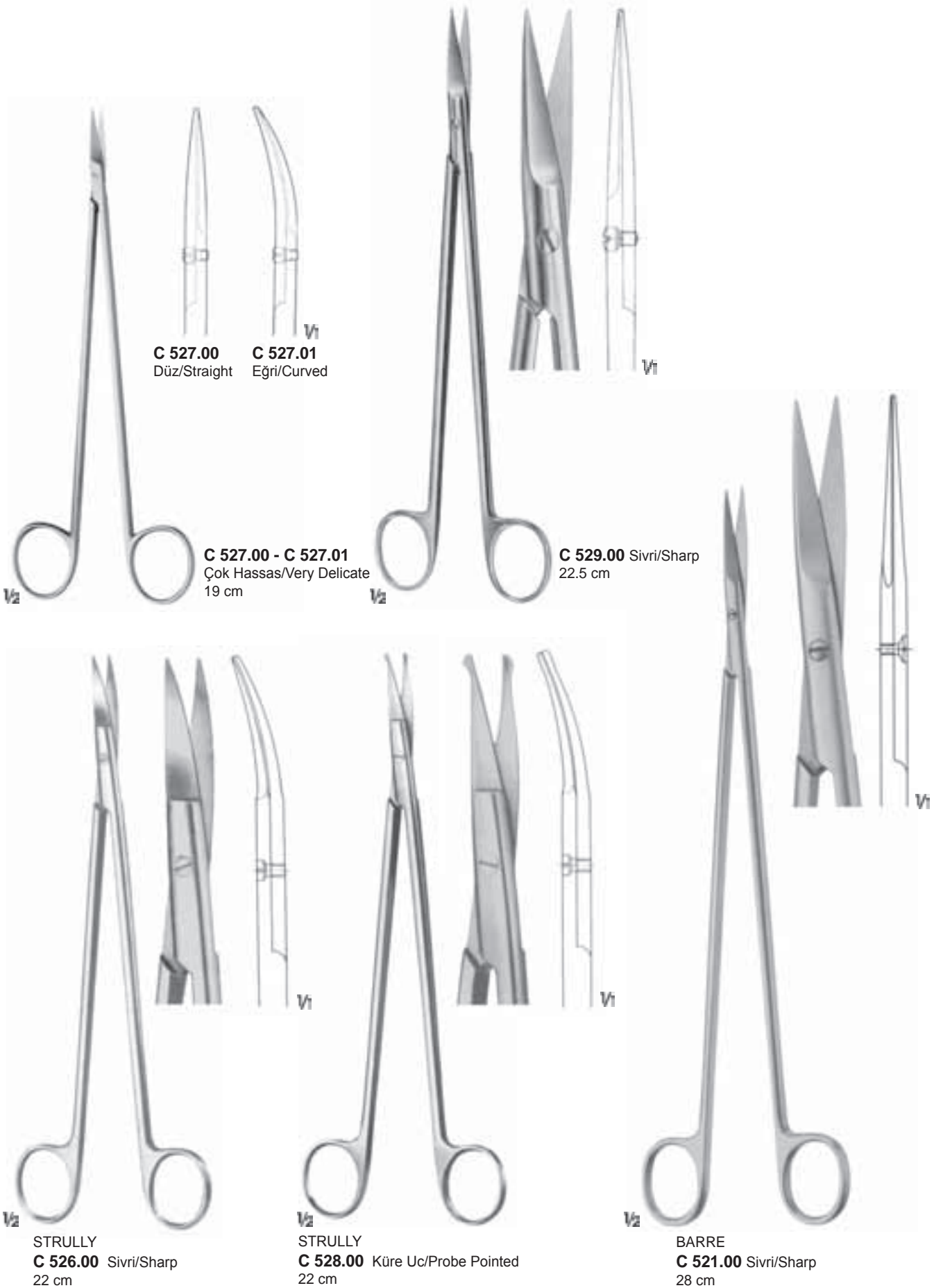

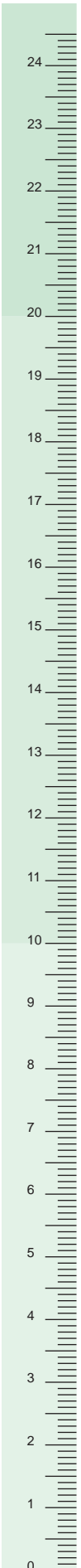
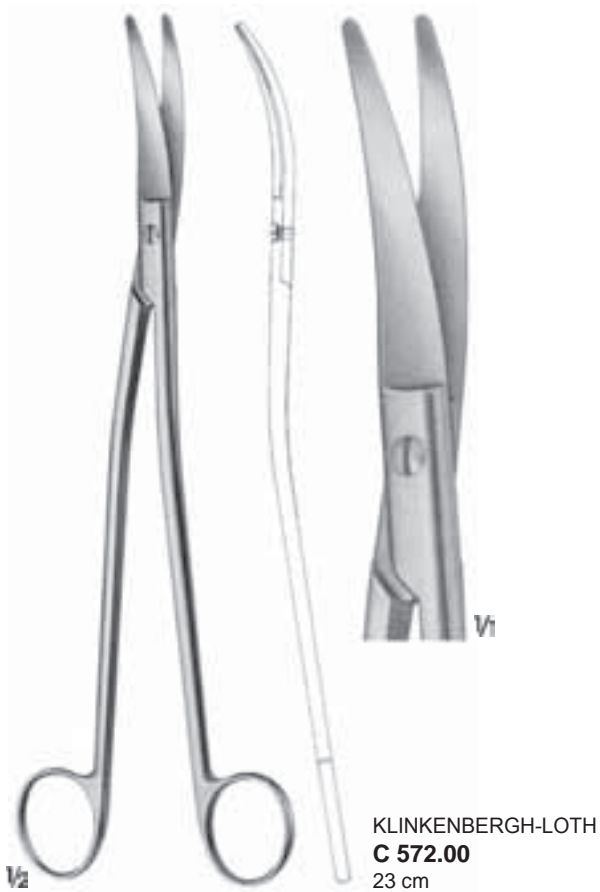
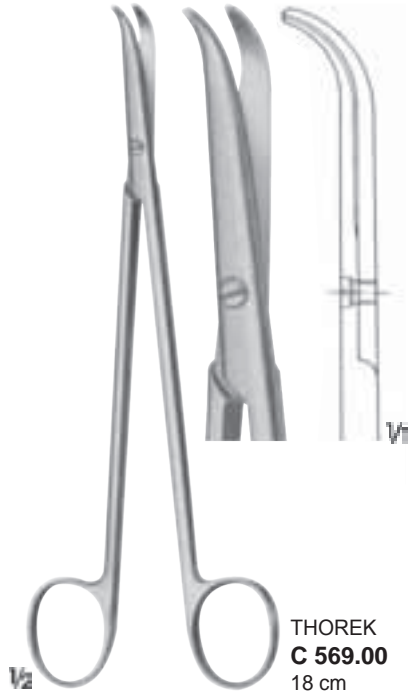



Karbür kesme ucu yerleştirilmiş *HardTips* makaslar

- Mükemmel kesim
- Uzun çalışma ömrü

HardTips scissors with inserted carbide cutting edges

- Excellent Cutting
- Long working

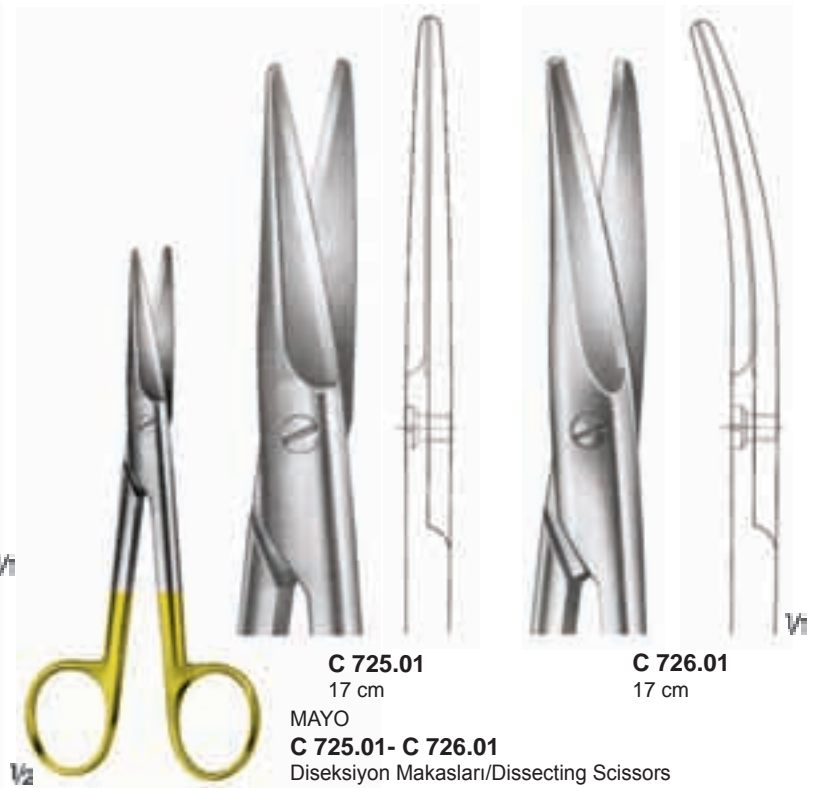
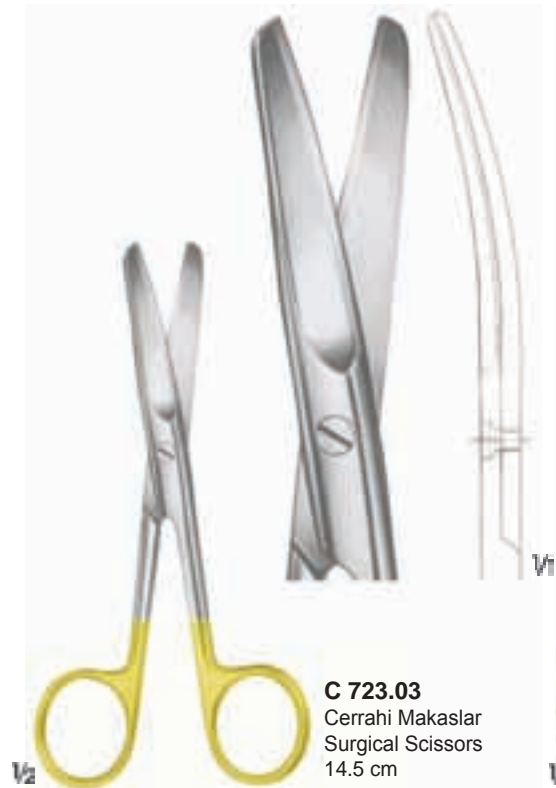
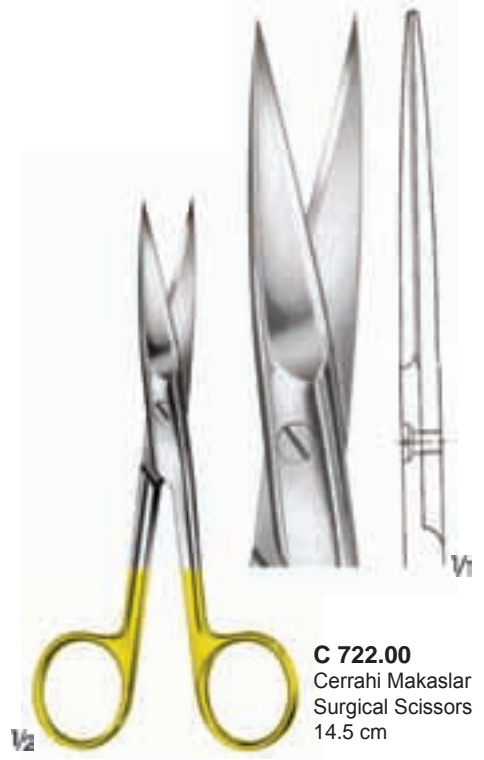



fineCut



fineCut

fineCut

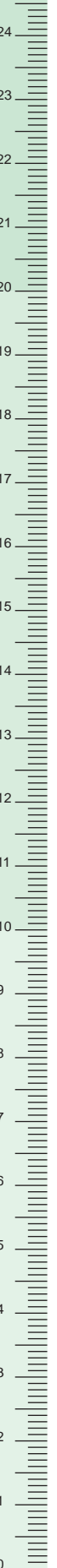



fineCut



TÖNNIS-ADSON
C 758.00 Eğri/Curved
17.5 cm

fineCut



NELSON-METZENBAUM
C 768.00 - C 768.02

C 768.00
26 cm

C 768.01
28 cm

C 768.02
28.5 cm

fineCut



METZENBAUM
C 763.00 - C 763.02

C 763.00
18 cm

C 763.01
20 cm

C 763.02
23 cm

fineCut



C 764.00
18 cm

C 764.01
20 cm

C 764.02
23 cm

METZENBAUM
C 764.00 - C 764.02

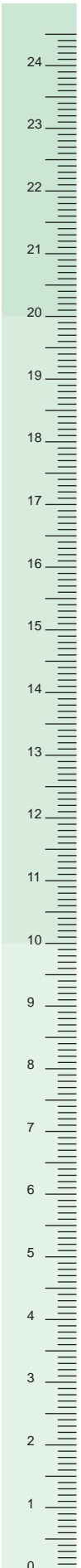
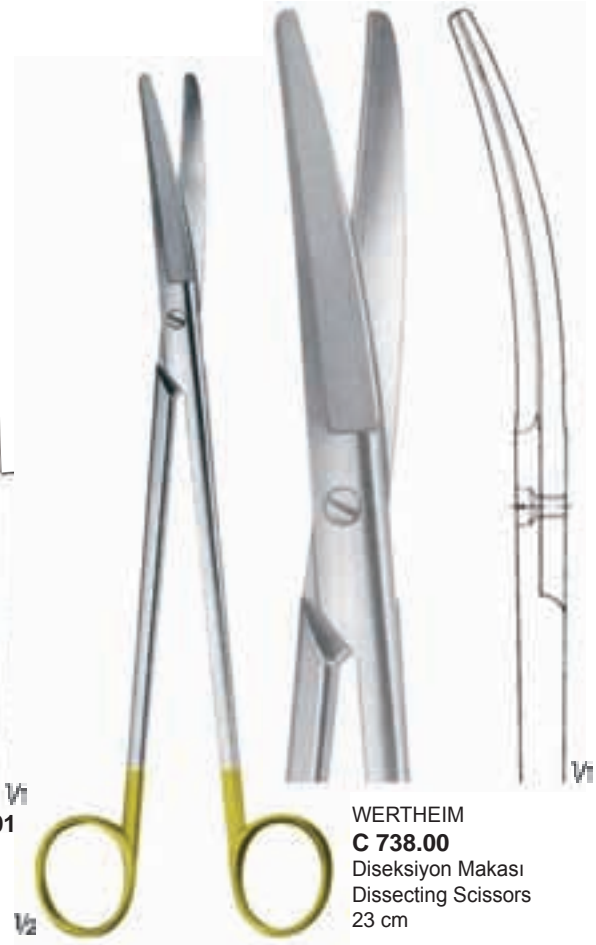
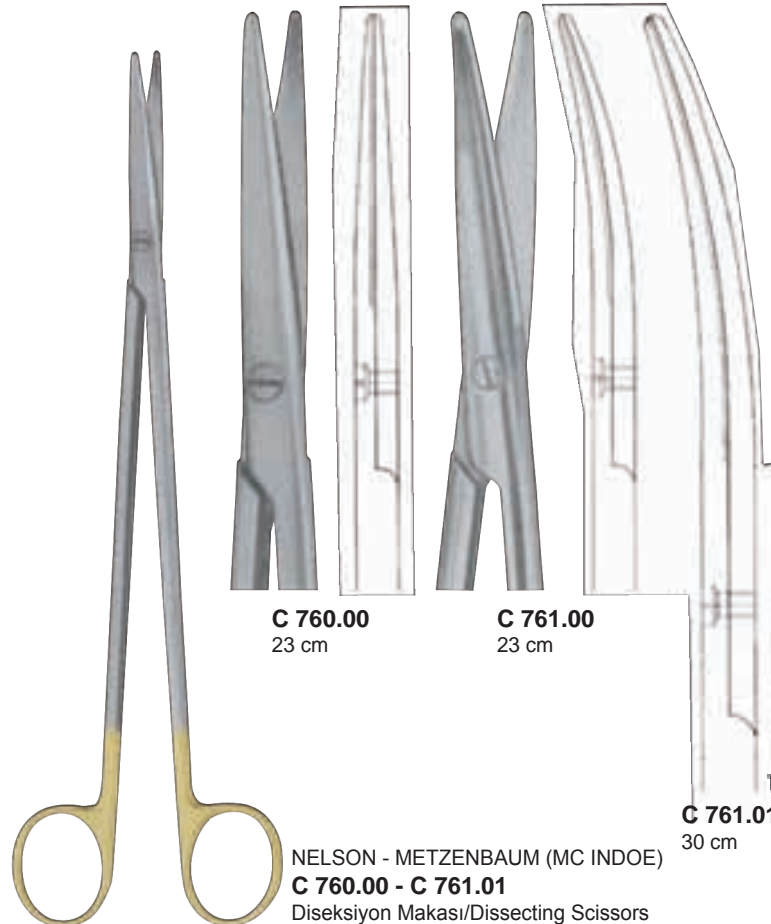

HardTips



1/2

Tek ağız tırtıllı
One jaw serrated

C 798.00
12 cm

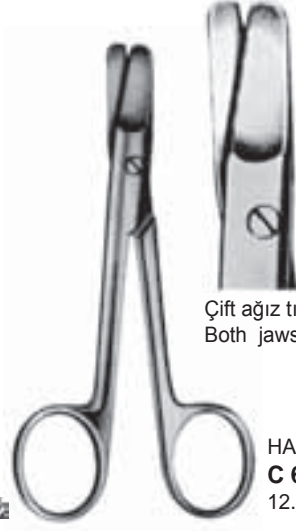

1/2

Çift ağız tırtıllı
Both jaws serrated

HARVEY
C 666.00
12.5 cm



C 661.00



C 662.00



C 663.00
Geniş bleyd
Broad Bleyd



C 664.00
Tek ağız tırtıllı
One jaw serrated



C 665.00



1/2



1/2

BEEBE
C 661.00 - C 665.00
11 cm



Dikiş malzemelerinin kesimi için ;
- Karbid uçları kalıcı keskinlik sağlar. (Makas ağzının uçları da dahil)
- Tırtıklı ağız dikiş malzemelerinin dışarıya kaymasını engeller.

Cutting suture materials;
- Carbide inserts provide lasting sharpness (including tip of the blades of the scissors)
- Serrated edges prevents suture materials from slipping out.



C 781.01
C 780.00 - C 780.03
Tek ağız tırtıllı
One jaw serrated
18 cm



C 781.01
Tek ağız tırtıllı
One jaw serrated
14.5 cm



C 780.00
Tek ağız tırtıllı
One jaw serrated
18 cm



C 780.02
Tek ağız tırtıllı
One jaw serrated
23 cm



C 780.03
Tek ağız tırtıllı
One jaw serrated
26 cm

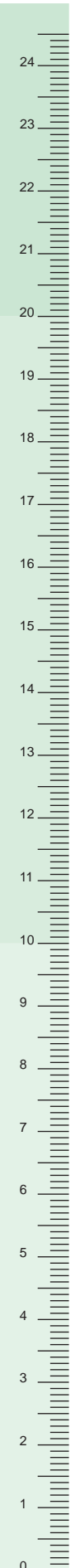



Dikiş malzemelerinin kesimi için ;

- Karbid uçları kalıcı keskinlik sağlar. (Makas ağzının uçları da dahil)
- Tırtıklı ağız dikiş malzemelerinin dışarıya kaymasını engeller.

Cutting suture materials;

- Carbide inserts provide lasting sharpness (including tip of the blades of the scissors)
- Serrated edges prevents suture materials from slipping out.

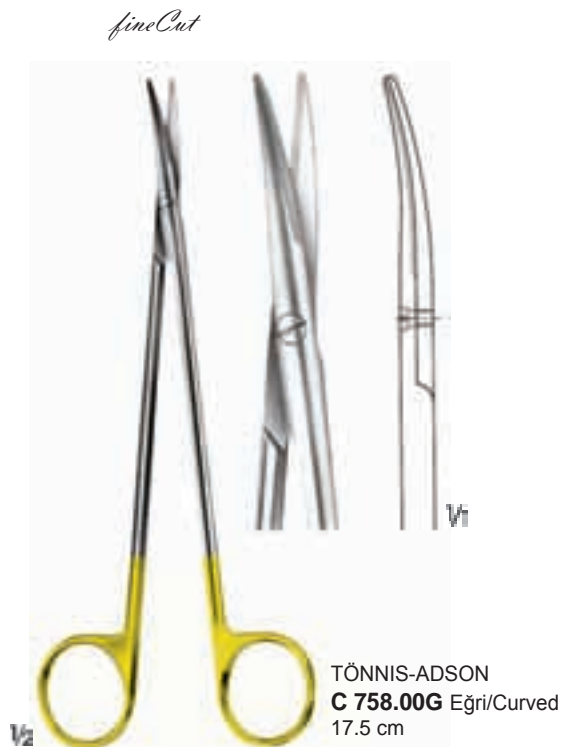



C 723.03G
Cerrahi Makaslar/Surgical Scissors
14.5 cm



fineCut
LEXER C 730.00G
Diseksiyon Makası/Dissecting Scissors
Dar/Narrow
16.5 cm



fineCut
NELSON-METZENBAUM
C 768.00G - C 768.02G
Diseksiyon Makası/Dissecting Scissors

C 768.00G 26 cm
C 768.01G 28 cm
C 768.02G 28.5 cm

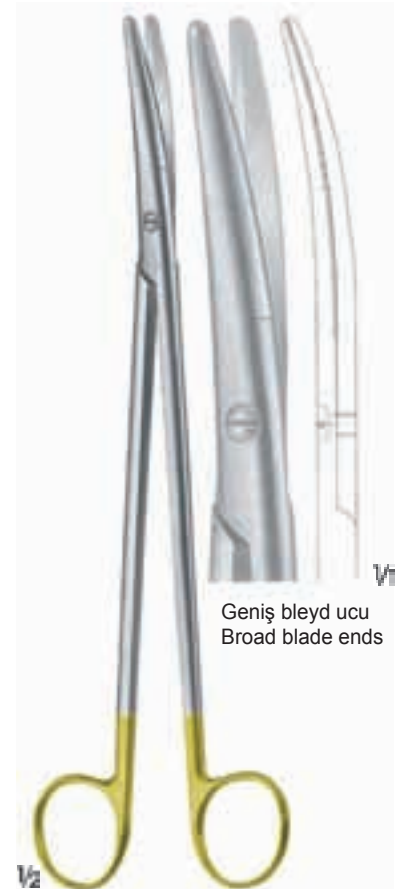

METZENBAUM
C 766.00G
Diseksiyon Makası/Dissecting Scissors
23 cm

Geniş bleyd ucu
Broad blade ends

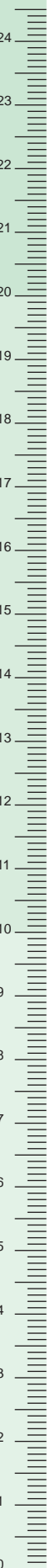

Kavrama yüzeyini artıran hafif plastik tutamak:

- Kramp oluşturmeyen, doğal tutma pozisyonu ve duyarlılık sağlar.
- Yuvarlak tutma kesiti aletin kolay ve düzgün rotasyonunu sağlar. Böylelikle uygulama ve çalışma alanı genişler.
- Pimli tutma profili güvenli tutmayı garanti eder.
- Ergonomik, hafif plastik sap yorulmadan optimum kullanım sağlar.

Lightweigh plastic handles to increase grip surface:

- Provides cramp free, natural holding positions and sensitivity
- Round cross-section of the instrument provides an easy and smooth rotation. Expands the working and application area.
- Retention profile with pin ensures safe griping.
- Ergonomic, light weight plastic handle provides fatigue free, optimal usage.

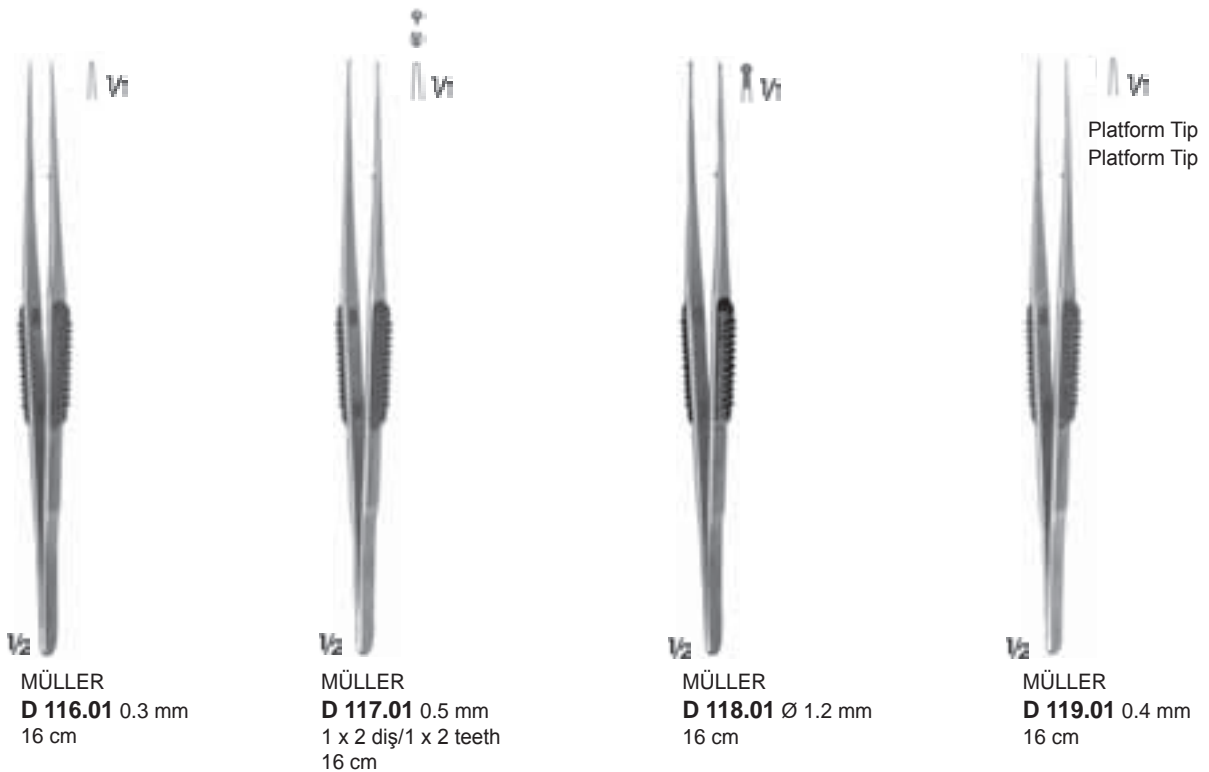
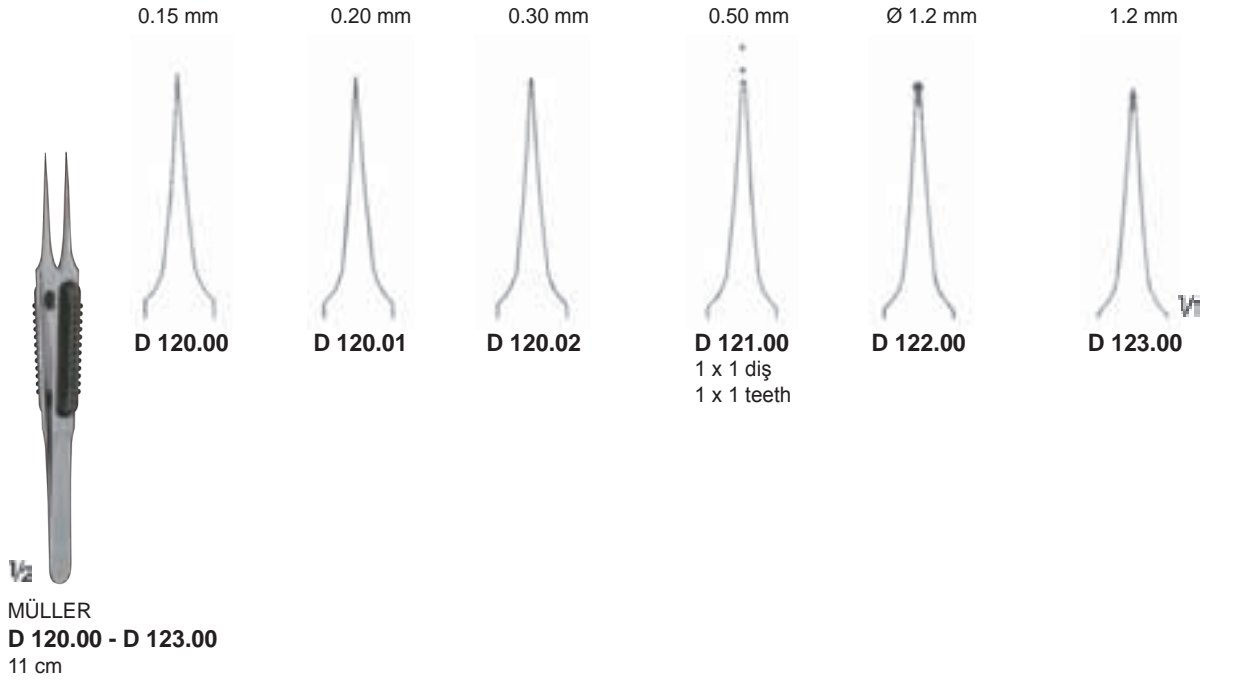

Yuvarlak Saplar

- Parmaklar arasında istenildiği şekilde döndürmeye izin verir.
- Sağlam veya oyulmuş saplardan dolayı her bir alette optimum denge sağlar

Round Handle

- Allows rotation between the fingers as required
- Due to carved and strong handle, each instrument provides optimum balance

0.3 mm

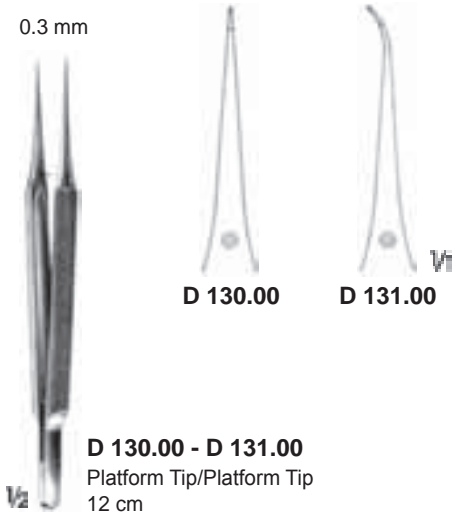

D 130.00 - D 131.00
Platform Tip/Platform Tip
12 cm

0.3 mm



D 130.01 - D 131.01
Platform Tip/Platform Tip
15 cm

0.6 mm

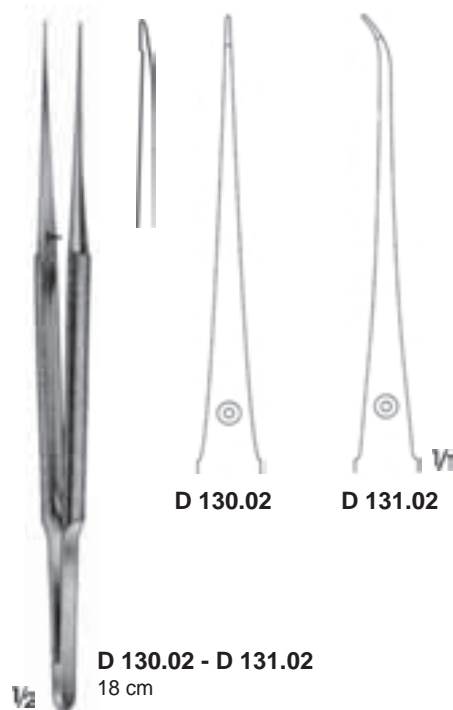

D 130.02 - D 131.02
Platform Tip/Platform Tip
18 cm

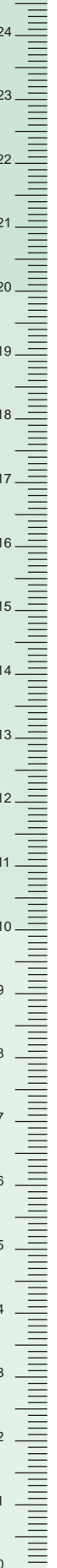

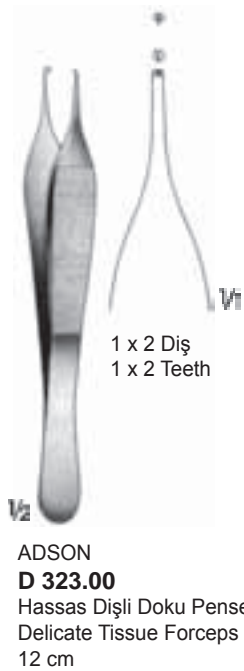
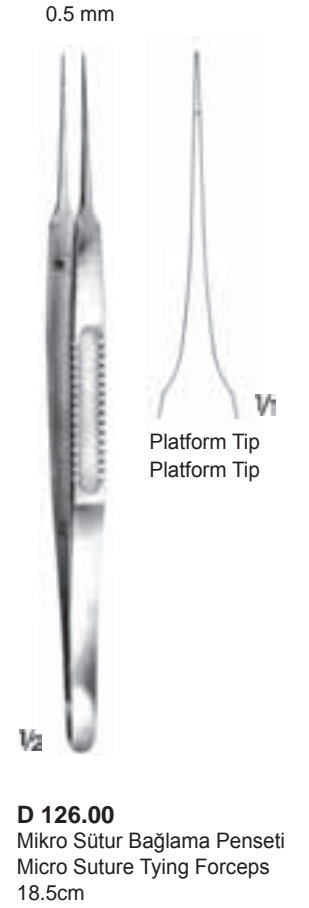
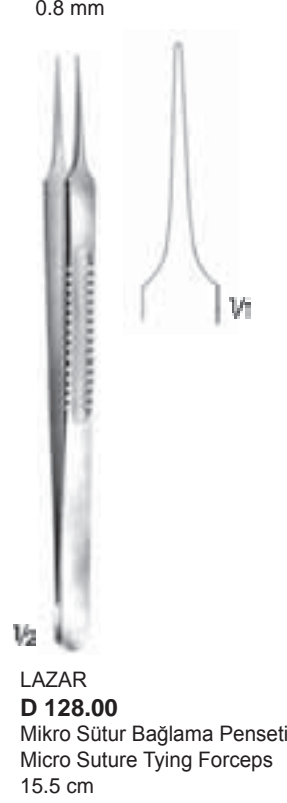
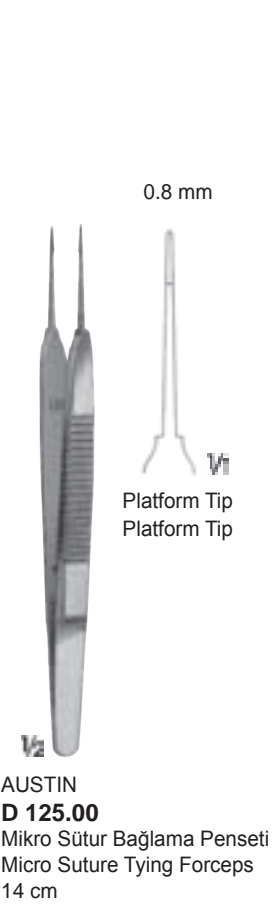

1 x 2 Diş
1 x 2 Teeth

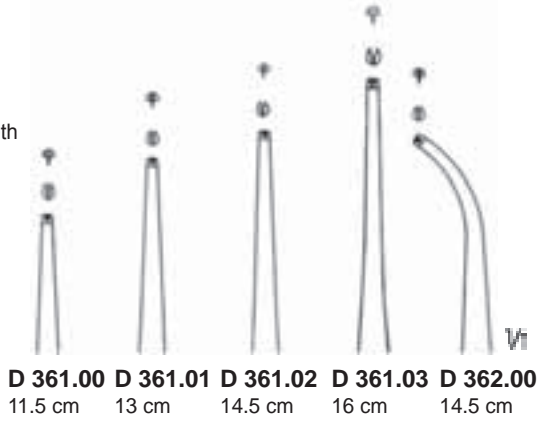

D 361.00 - D 362.00
Orta/Medium

1 x 2 Diş
1 x 2 Teeth



D 363.00-D 363.01



D 360.04
Standart Model
Standard Pattern
16 cm



D 370.02
16 cm



BROWN
D 341.00 15 cm
D 341.02 20 cm
D 341.03 25 cm

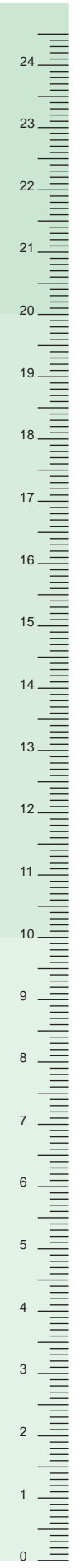

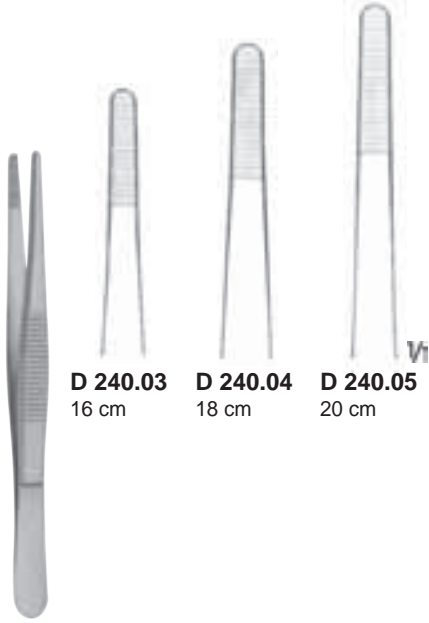

STANDART
D 240.03 - D 240.05
Standart Model/Standard Pattern
Diseksiyon Penseti/Dissecting Forceps

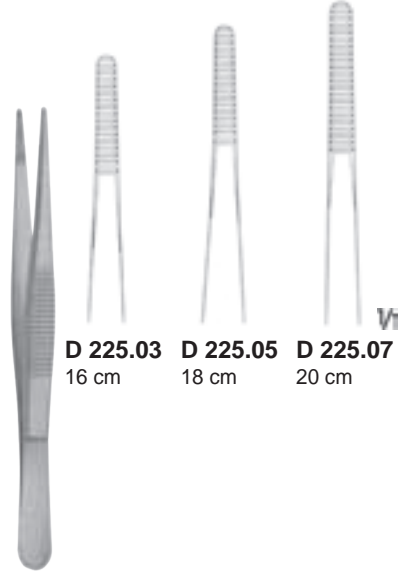

D 225.03 - D 225.07
Orta/Medium
Diseksiyon Penseti/Dissecting Forceps

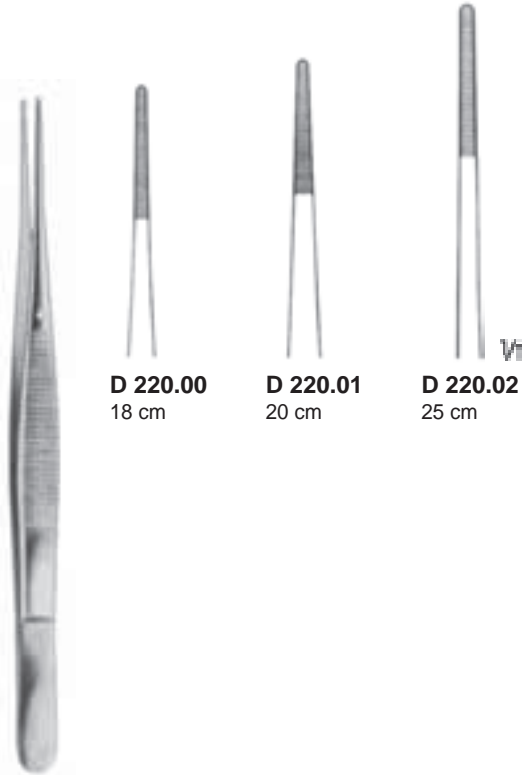

CUSHING
D 220.00 - D 220.02
Hassas Diseksiyon Penseti
Delicate Dissecting Forceps

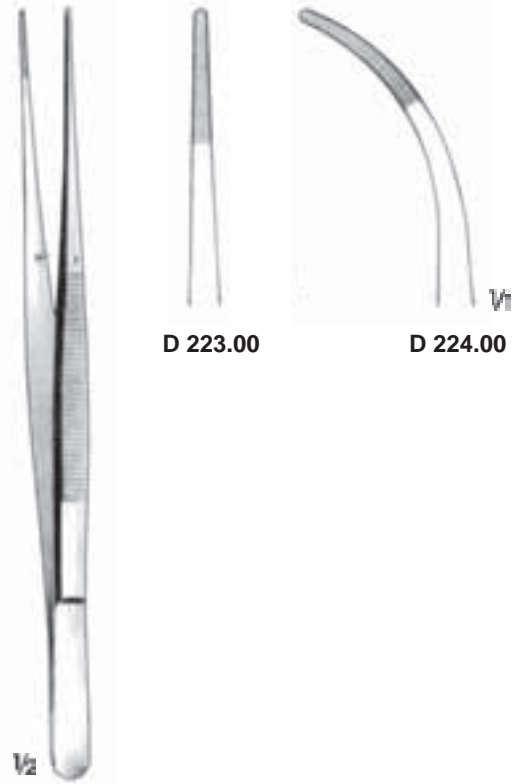

BROPHY
D 223.00 - D 224.00
Hassas Diseksiyon Penseti
Delicate Dissecting Forceps
20 cm

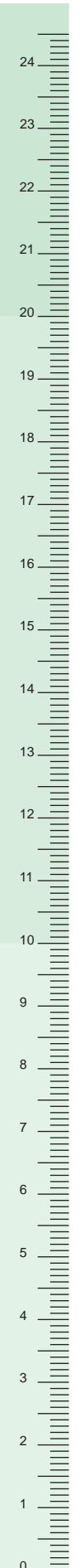
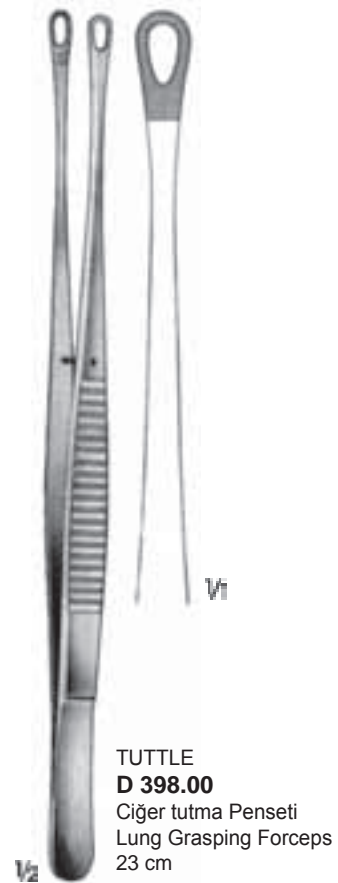
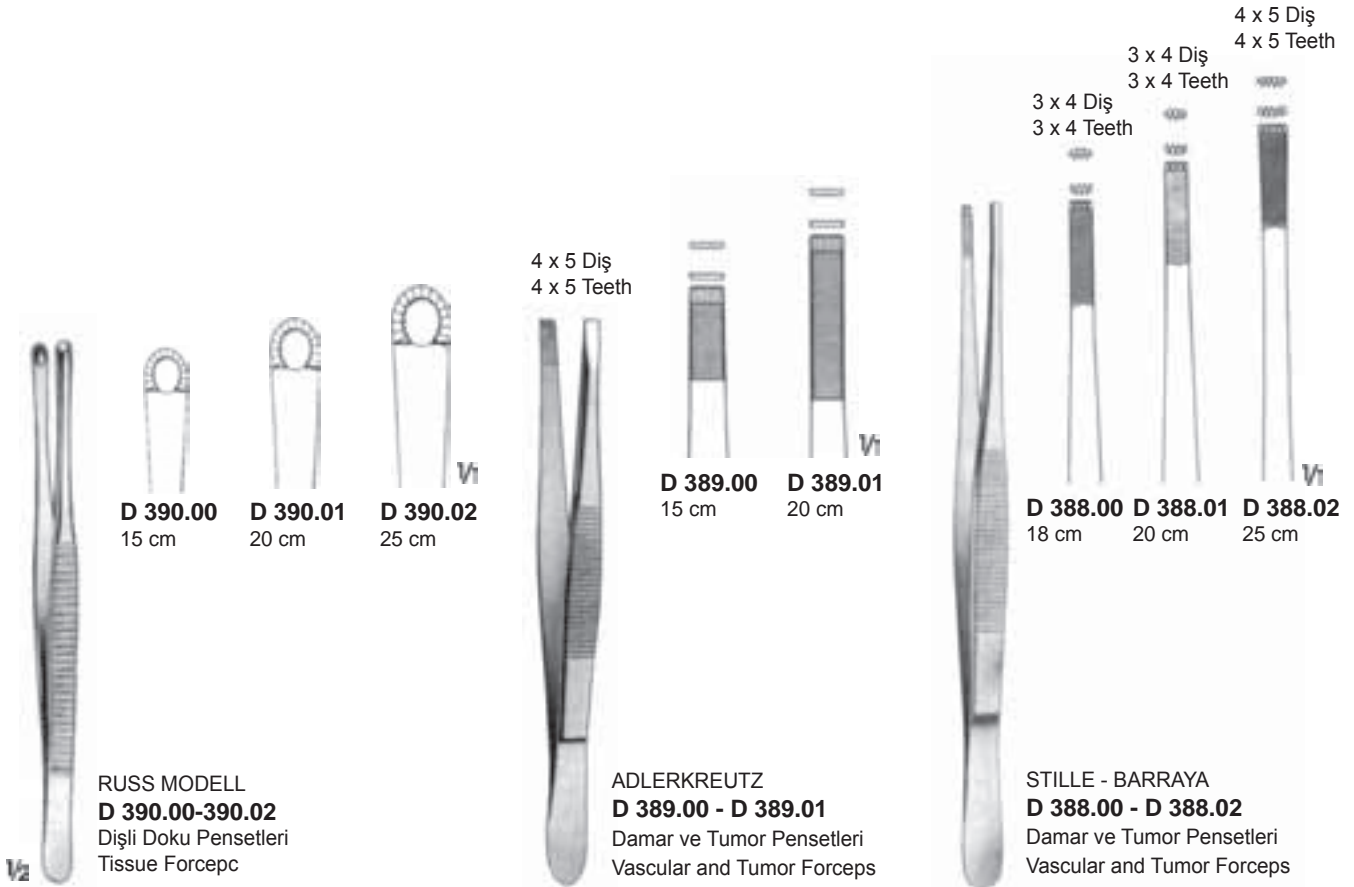

De Bakey Diş



Toothing De Bakey

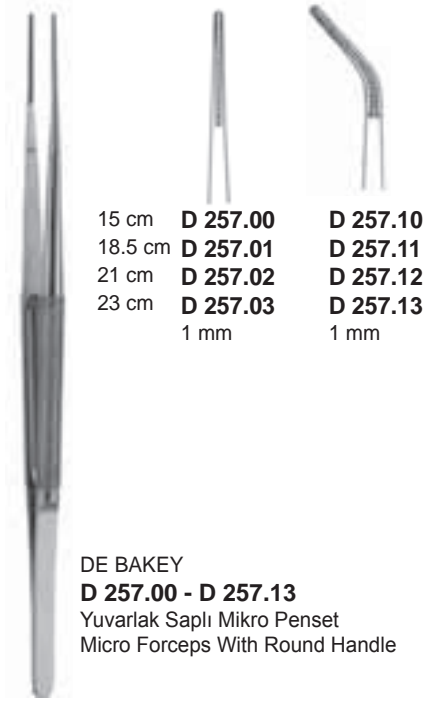

15 cm **D 257.00** **D 257.10**
18.5 cm **D 257.01** **D 257.11**
21 cm **D 257.02** **D 257.12**
23 cm **D 257.03** **D 257.13**
1 mm 1 mm

DE BAKEY
D 257.00 - D 257.13
Yuvarlak Saplı Mikro Penset
Micro Forceps With Round Handle

1.0 mm



DE BAKEY
D 258.03 18.5 cm
D 258.04 21 cm
Yuvarlak Saplı Mikro Penset
Micro Forceps With Round Handle

1.0 mm



DE BAKEY
D 256.01 18 cm
D 256.02 20 cm
Düz Saplı Mikro Penset
Micro Forceps With Flat Handle

Cooley Diş



Toothing Cooley

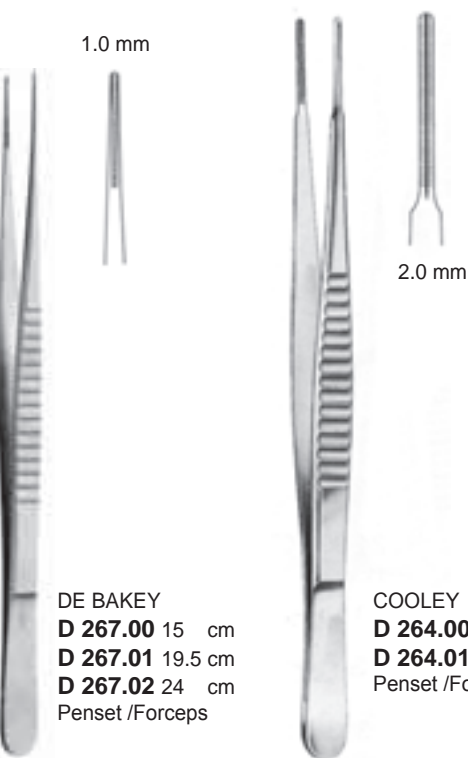

1.0 mm
DE BAKEY
D 267.00 15 cm
D 267.01 19.5 cm
D 267.02 24 cm
Penset /Forceps

2.0 mm

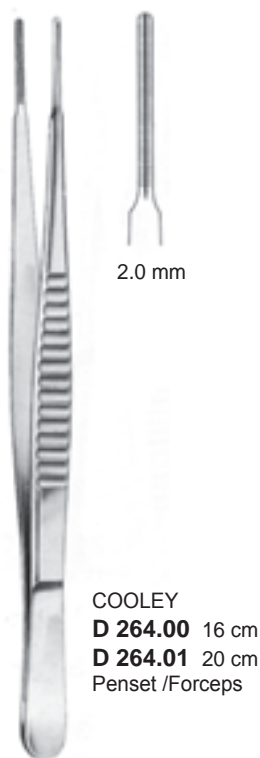

COOLEY
D 264.00 16 cm
D 264.01 20 cm
Penset /Forceps

2.7 mm



DE BAKEY
D 269.00 15 cm
D 269.01 19.5 cm
D 269.02 24 cm
D 269.03 30 cm
Penset /Forceps

2 mm

2 mm

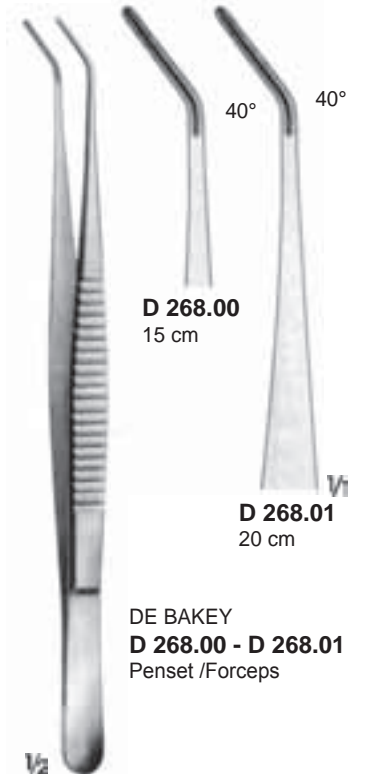

D 268.00
15 cm

D 268.01
20 cm

DE BAKEY
D 268.00 - D 268.01
Penset /Forceps

De Bakey Diş



Toothing De Bakey

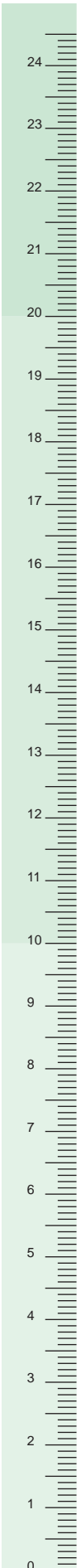
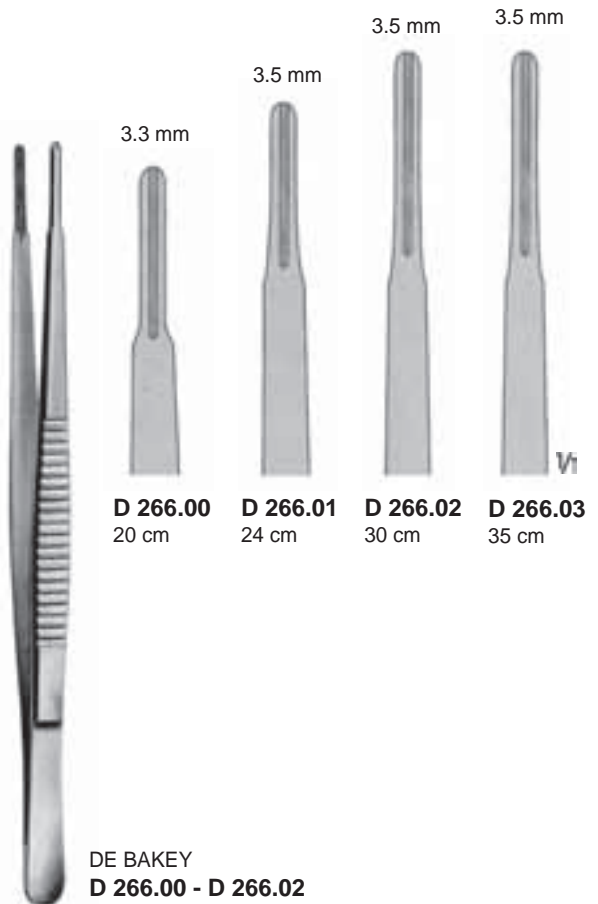
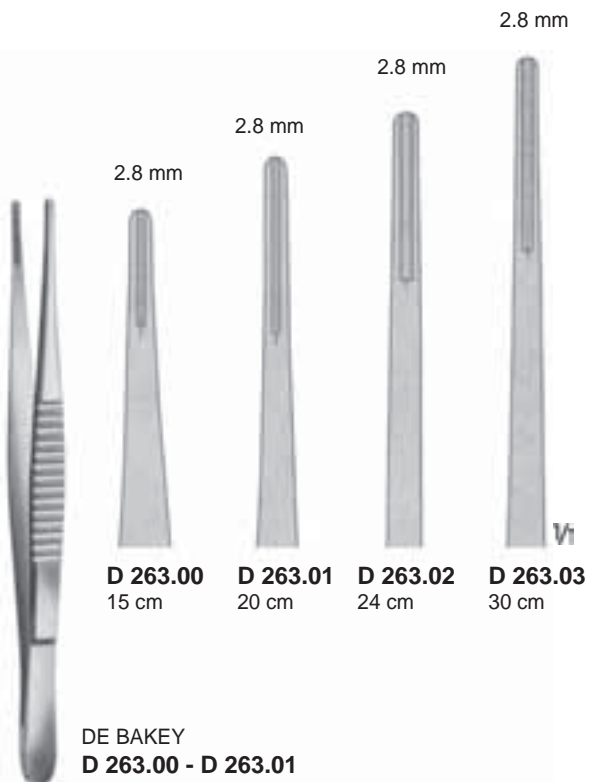
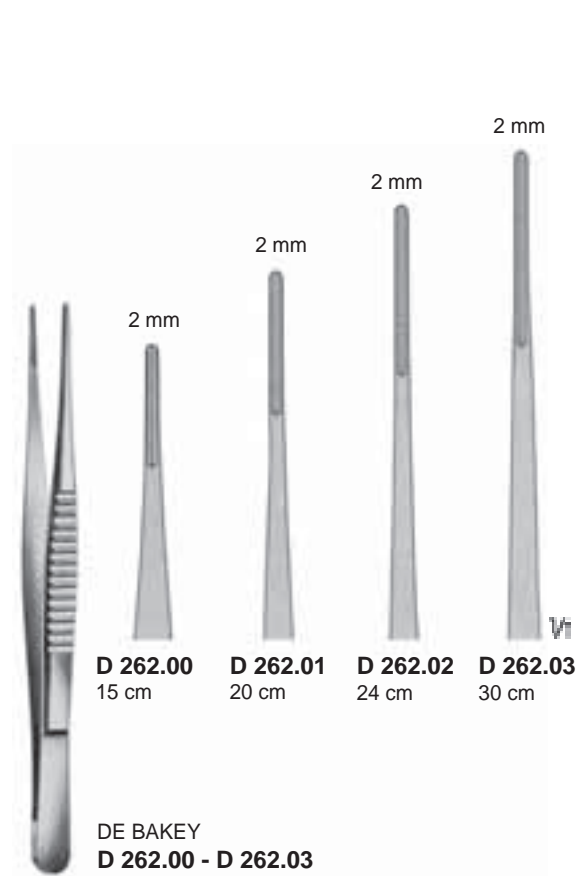
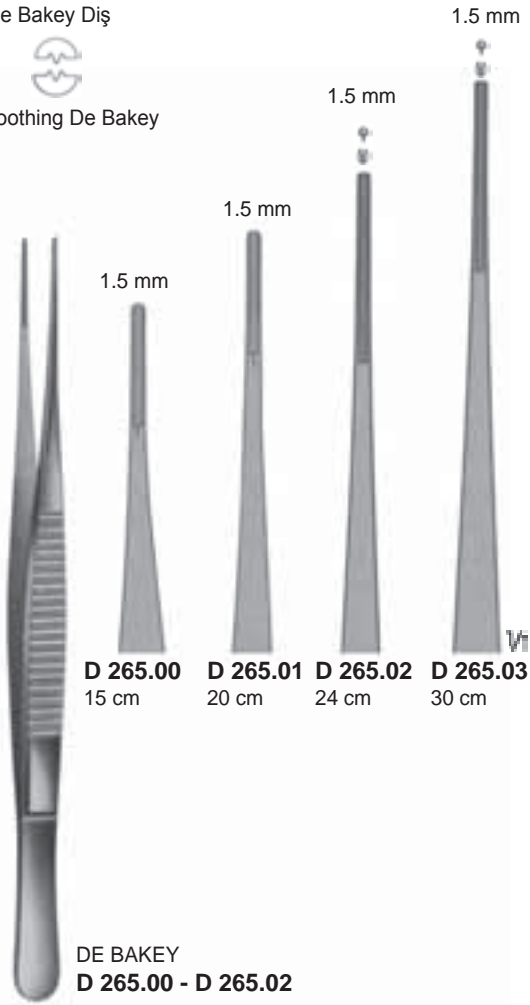

De Bakey Diş



Toothing De Bakey

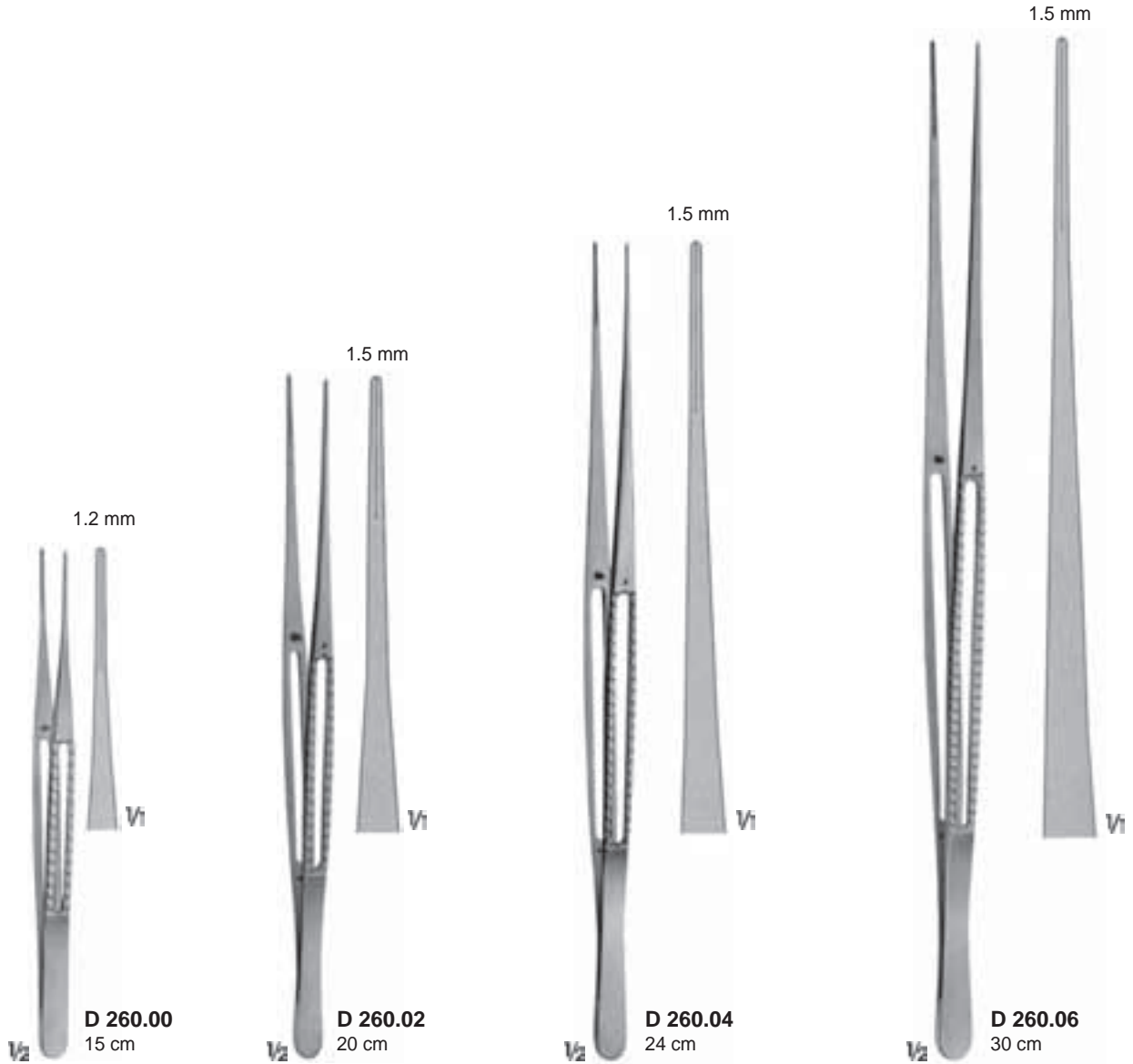

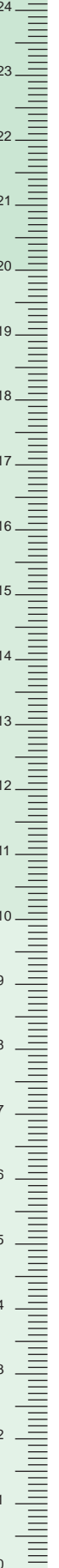
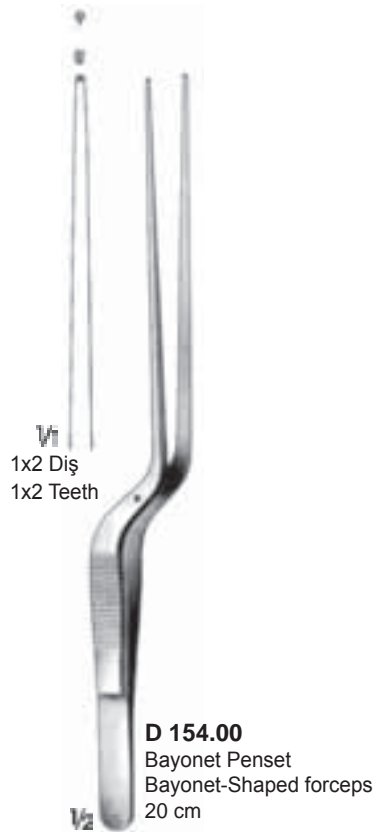
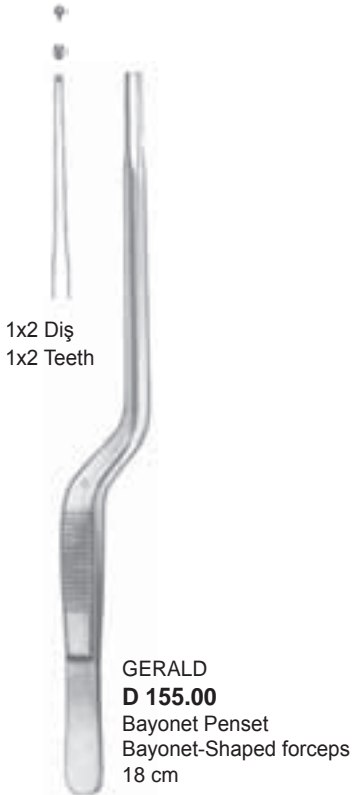
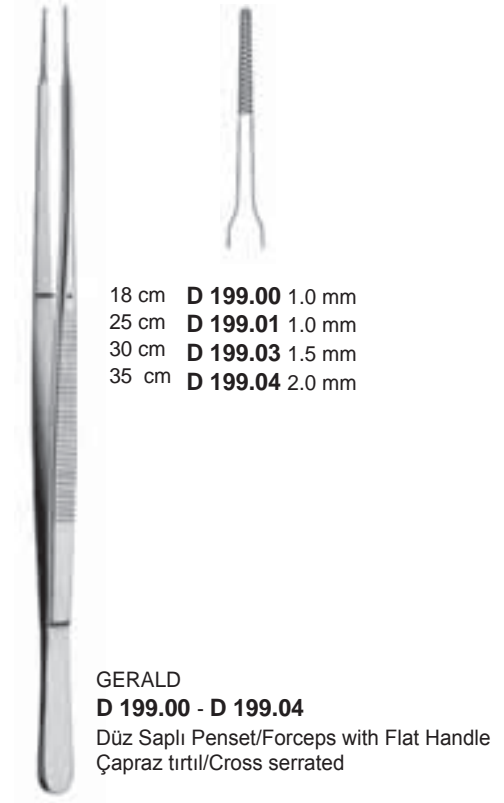







diaMote ağızlar, daha sert ve aşınmaya dayanıklı yüzeyler sağlar.



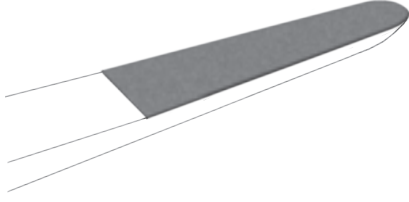

diaMote ağızlar, hassas iğne, suture ve dokuların güvenilir bir şekilde kavranmasını garanti eder.

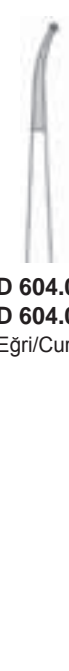
diaMote jaws provide harder and more wear resistant surfaces.

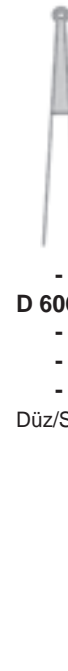
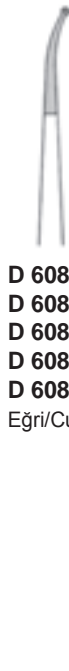
diaMote jaws ensure reliable grip of fine needles, sutures and tissues.



Ø 1.0 mm			Ø 1.0 mm			Ø 1.0 mm			Ø 1.0 mm			Ø 2.0 mm			Ø 1.0 mm		
																	
18.5 cm	D 601.03								15 cm	D 606.01	-						D 608.01
21 cm	D 601.05								18.5 cm	D 606.03	D 606.13						D 608.03
	Platform Tip, Düz								21 cm	D 606.05	-						D 608.05
	Platform Tip, Straight								23 cm	D 606.06	-						D 608.06
									25 cm	D 606.08	-						D 608.08
										Düz/Straight		Düz/Straight					Eğri/Curved
D 601.03 - D 604.05									D 606.01 - D 608.08								

Ø 2.5 mm		Ø 2.5 mm		Ø 1.2 mm		Ø 1.2 mm	
							
	D 618.03		D 618.05		D 615.01		D 615.03
	18 cm		20 cm		18 cm		22 cm
D 618.03 - D 618.05				D 615.01 - D 615.03			



18.5 cm **D 630.02**
21 cm **D 630.04**
Platform Tip, Düz
Platform Tip, Straight

D 630.02 - D 630.04
Yuvarlak Sap/Round Handle

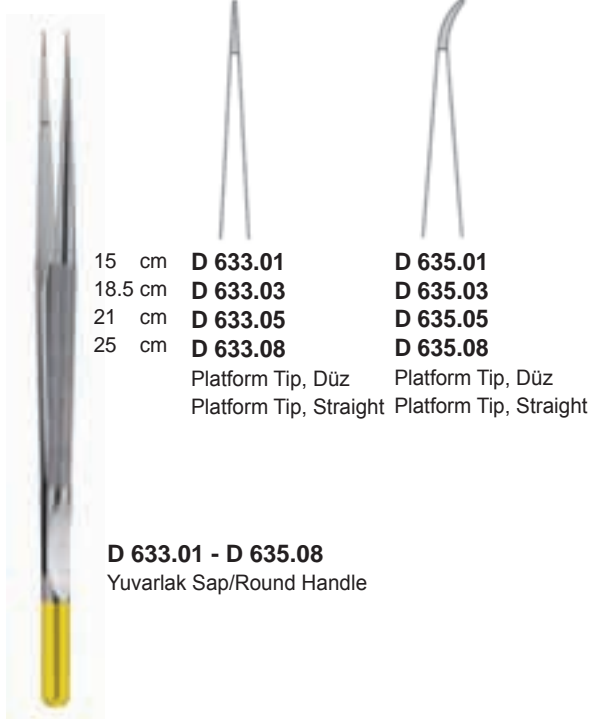

15 cm **D 633.01**
18.5 cm **D 633.03**
21 cm **D 633.05**
25 cm **D 633.08**
Platform Tip, Düz
Platform Tip, Straight

D 635.01
D 635.03
D 635.05
D 635.08
Platform Tip, Düz
Platform Tip, Straight

D 633.01 - D 635.08
Yuvarlak Sap/Round Handle



D 637.00
Micro Diseksiyon
Penset, Yuvarlak Sap
Micro Dissecting For-
ceps, Round Handle
18 cm

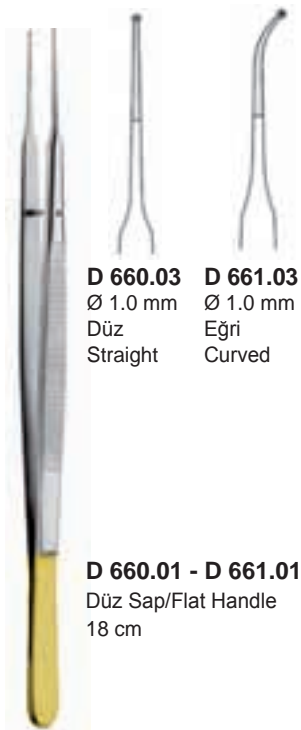

D 660.03 **D 661.03**
Ø 1.0 mm Ø 1.0 mm
Düz Eğri
Straight Curved

D 660.01 - D 661.01
Düz Sap/Flat Handle
18 cm

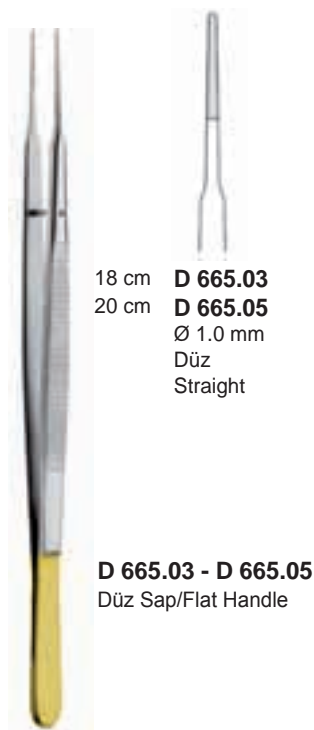

18 cm **D 665.03**
20 cm **D 665.05**
Ø 1.0 mm
Düz
Straight

D 665.03 - D 665.05
Düz Sap/Flat Handle



D 673.00 **D 673.10**
1 mm 1 mm
1x2 Diş 1x2 Diş
1x2 Teeth 1x2 Teeth

D 673.00 - D 373.10
Dişli Doku Pensetleri,
Düz Sap
Mikro Tissue Forceps
Flat Handle
18 cm



D 675.00 **D 675.10**
Düz Eğri
1x2 Diş 1x2 Diş
Straight Curved
1x2 Teeth 1x2 Teeth

D 675.00-D 675.10
Dişli Doku Pensetleri
Yuvarlak Sap
Mikro Tissue Forceps
Round Handle
18 cm

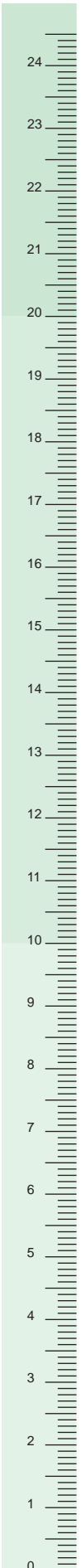

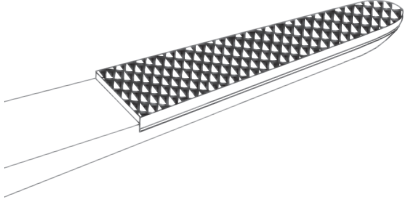

Karbid Uclu Diseksiyon Pensleri

- Ince yapılı karbid ucu sayesinde verimli kullanım...
- Sıkı şekilde ve dokuya zarar vermeden kavrama...
- Çok amaçlı kullanım
- Uzun Çalışma süresi

Carbide-tipped dissecting forceps

- Due-to slender carbide tip, efficient use
- Tight gripping without damaging the tissue
- Multi-purpose use
- Long working life

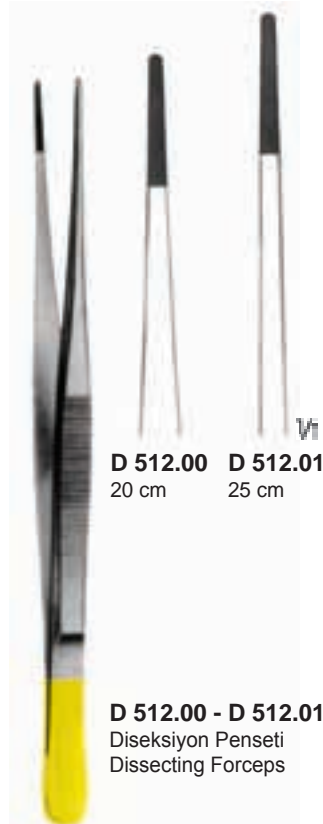
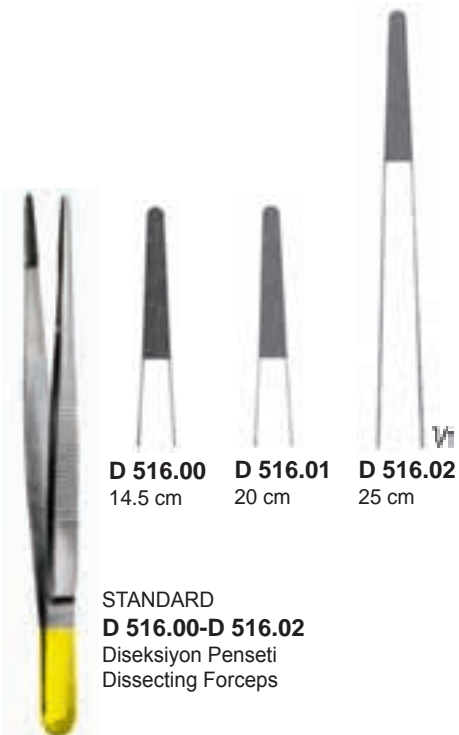



WANGENSTEEN
D 520.00-D 520.01

D 520.00
15 cm



D 520.01
23 cm



FERRIS-SMITH
D 523.00
17.5 cm



D 517.00 14 cm
D 517.01 16 cm



D 510.00 14.5 cm
D 510.01 18 cm

D 510.00 - D 510.01



CUSHING
D 513.00
18 cm

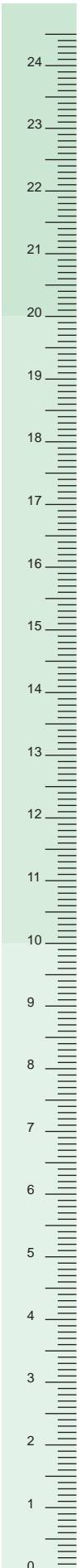

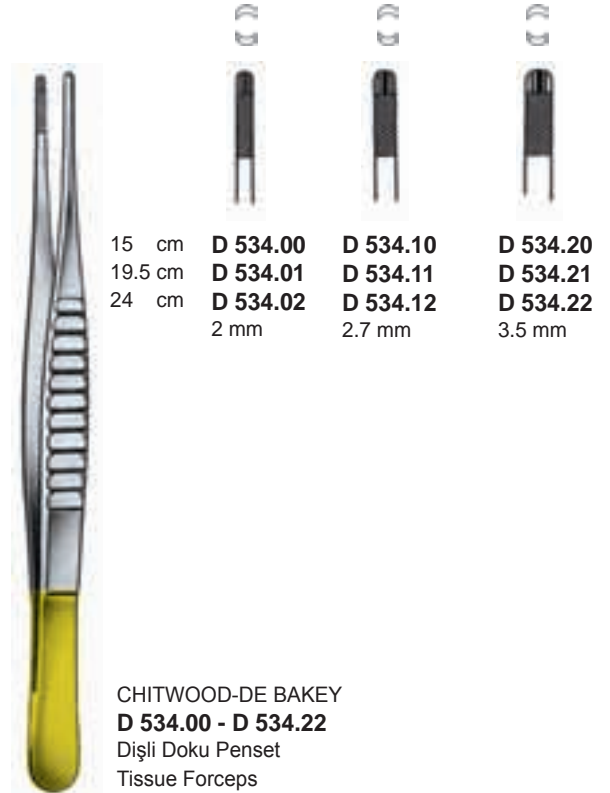
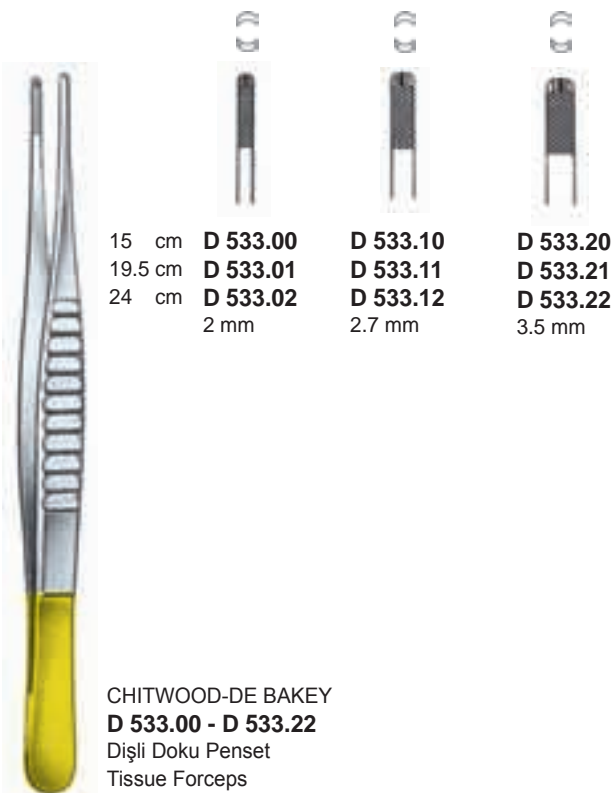

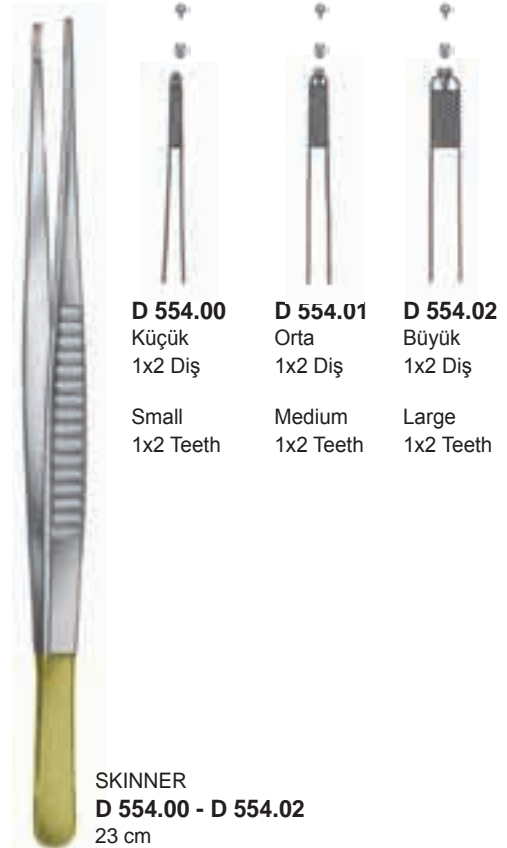
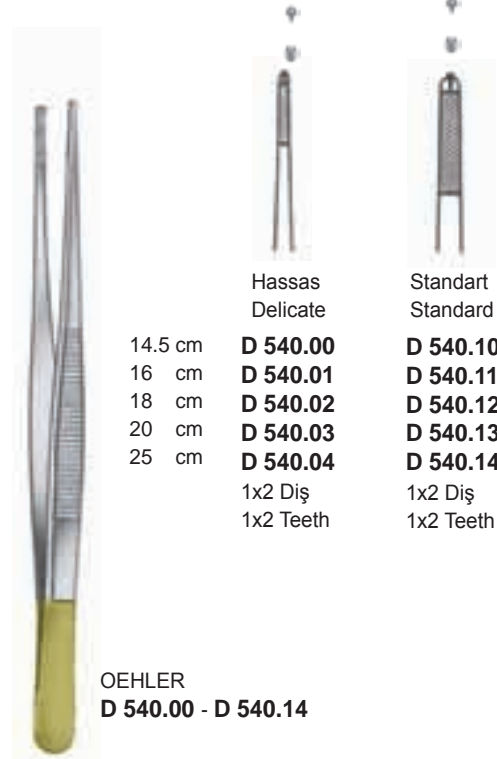

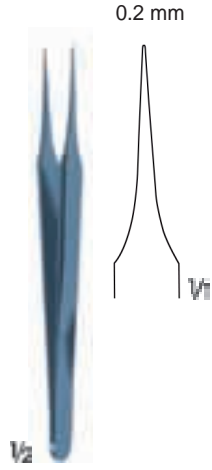

D 103.00T
Mikro Penset, Kuyumcu Tipi
Micro Forceps, Jeweler Patterns
11 cm

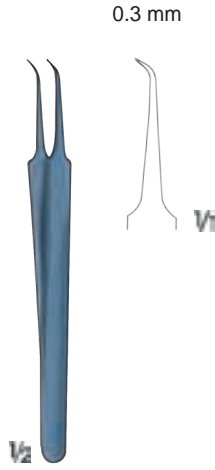

D 104.00T
Mikro Penset, Kuyumcu Tipi
Micro Forceps, Jeweler Patterns
11 cm

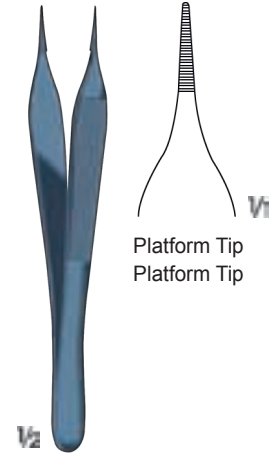

MICRO - ADSON
D 204.00T
Hassas Diseksiyon Penset
Delicate Dissecting Forceps
12 cm

diaMote

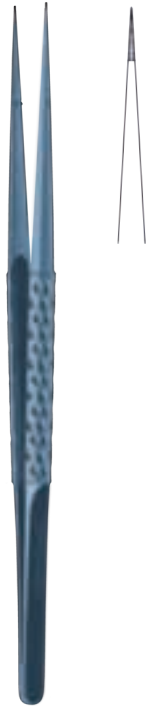

D 609.01T 18.5 cm
D 609.03T 21 cm
D 609.05T 23 cm
Platform Tip, Düz
Platform Tip, Straight

diaMote

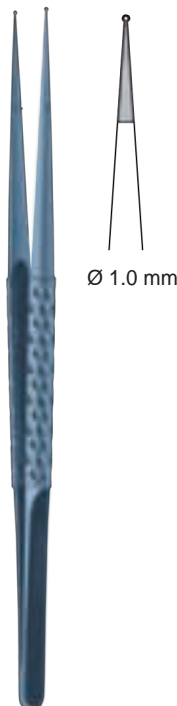

D 610.01T 18.5 cm
D 610.03T 21 cm
D 610.05T 23 cm
Düz, Straight

De Bakey Diş



Toothing De Bakey

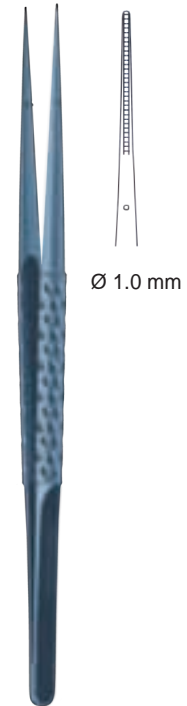

D 257.01T 18.5 cm
D 257.02T 21 cm
D 257.03T 23 cm
Düz, Straight

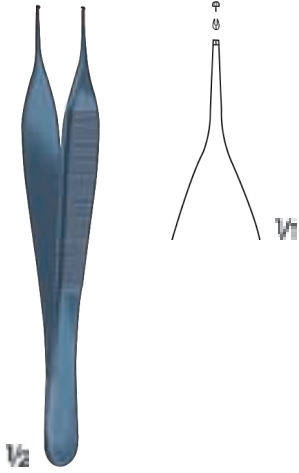

MICRO - ADSON
D 322.00T
Hassas Dişli Doku Penset
Delicate Tissue Forceps
12 cm

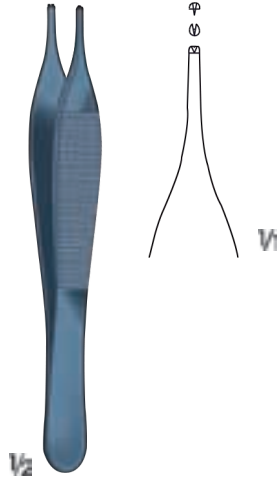

ADSON
D 323.00T
Hassas Dişli Doku Penset
Delicate Tissue Forceps
12 cm

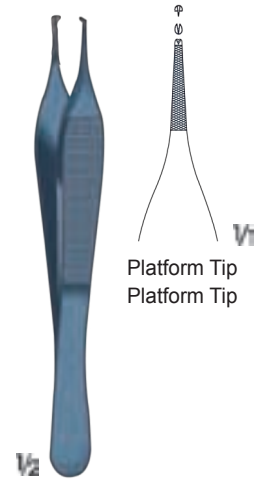

ADSON
D 324.00T
Hassas Dişli Doku Penset
Delicate Tissue Forceps
12 cm

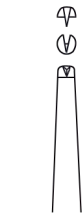

D 360.02T
13 cm



D 360.03T
14.5 cm



D 360.04T
16 cm



D 360.05T
18 cm



D 360.06T
20 cm

D 360.02T - D 360.06T
Dişli Doku Penset, Standart Model
Tissue Forceps, Standard Patterns

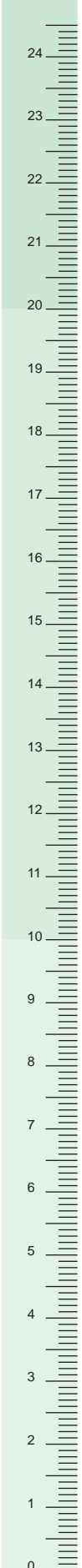

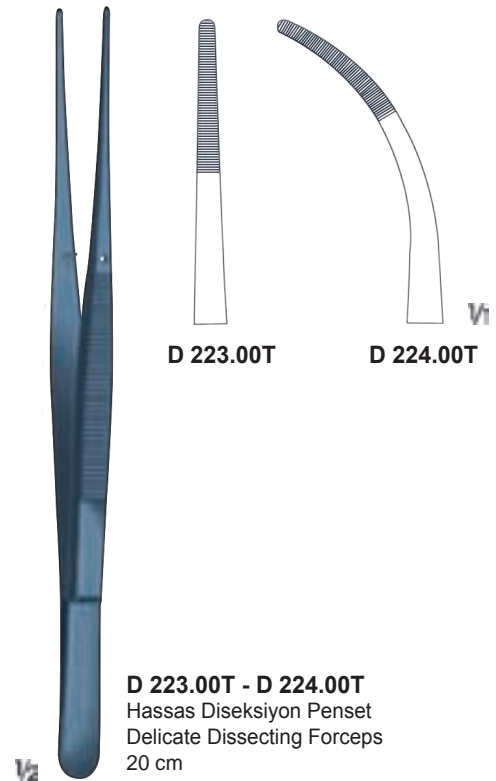
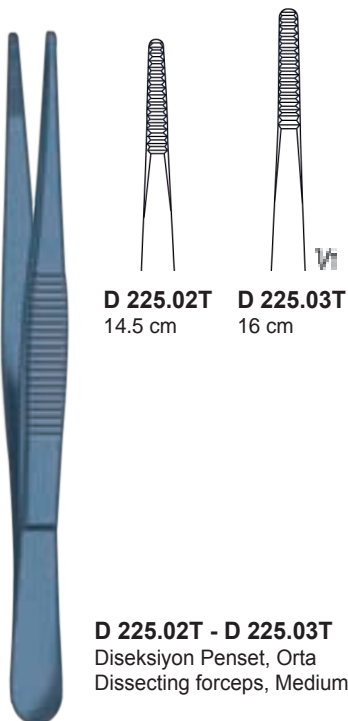
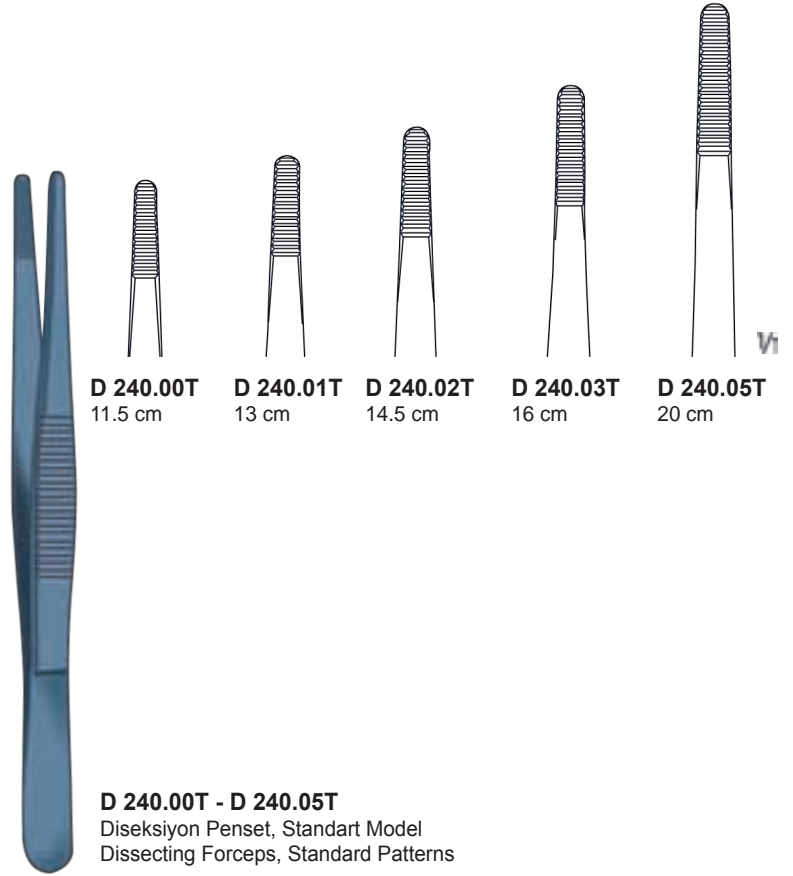
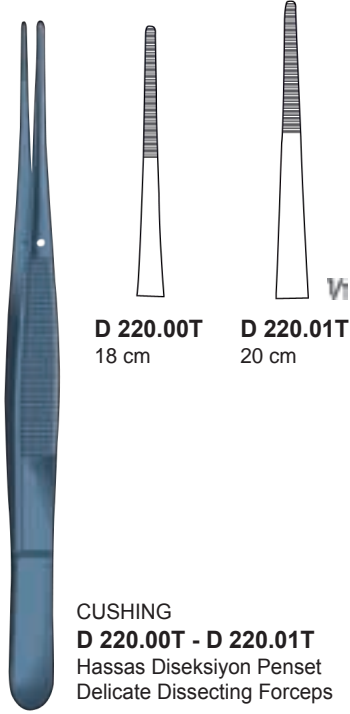

De Bakey Diş



Toothing De Bakey

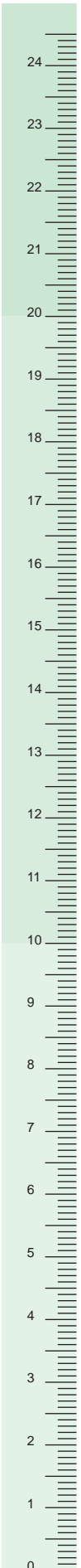
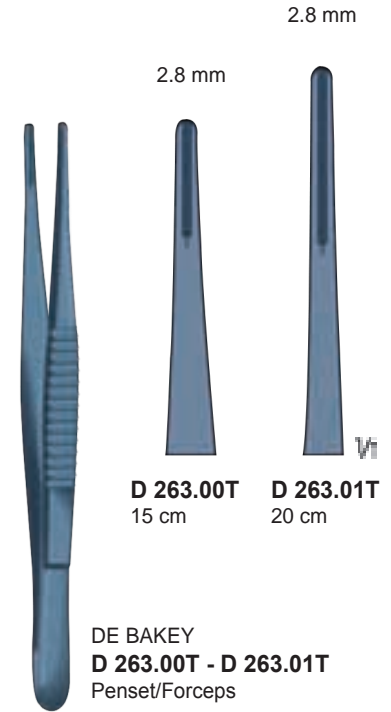
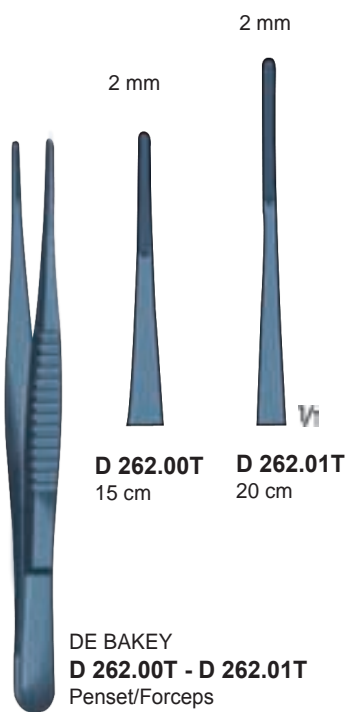
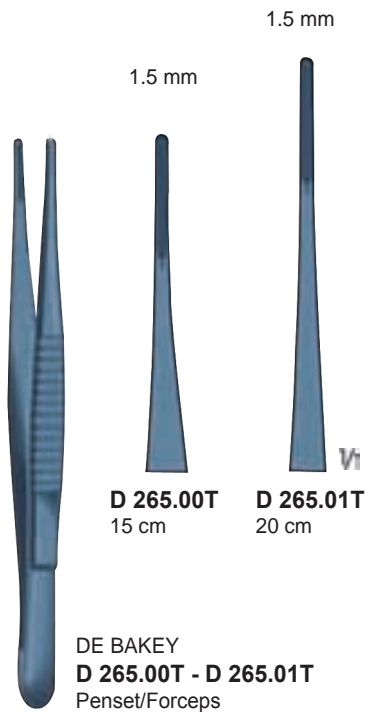
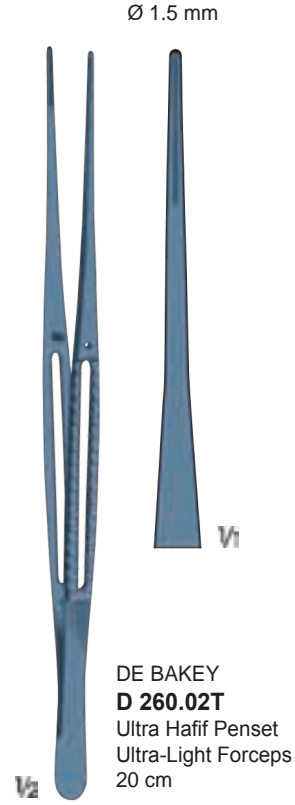
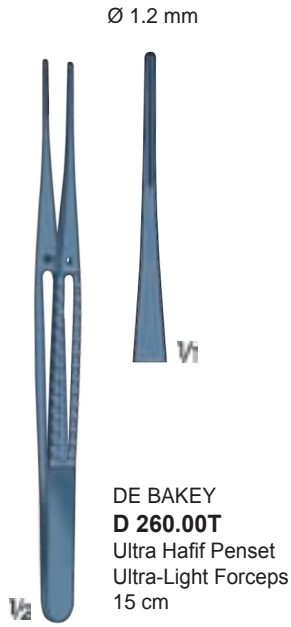



1 x 2 diş / 1 x 2 teeth

LANE
E 522.00 13 cm
E 522.01 19.5 cm
 Doku Tutma Pensi
 Tissue Grasping Forceps



2 x 3 diş / 2 x 3 teeth

LITTLEWOOD
E 523.00
 Doku Tutma Pensi
 Tissue Grasping Forceps
 19 cm



E 056.00

E 057.00

E 056.00 - E 057.00
 Pansuman Pensleri
 Dressing Forceps
 24 cm

E 058.00

E 059.00

SIMS-MAIER
E 058.00 - E 059.00
 Spanç Pensleri
 Sponge Forceps
 28 cm



WILLIAMS
E 178.00

Organ ve Doku Tutma Pensi
Organ and Tissue Grasping Forceps
16 cm



BLAKE
E 620.00

Embolus Tutma Pensi
Embolus Grasping Forceps
20.5 cm



BORST
E 199.00

Aort içinde etkili doku yapıştırması için pens, tespit klempli
Forceps for efficient tissue gluing in aortic, Fixation Clamp
21.5 cm



TEALE

E 153.00

Valf Tutma Pensi
Valve Grasping Forceps
23 cm



E 446.00

Atomatik geneli tüp tutma pens, özellikle kalp damar cerrahisi HLM tüpleri için uygun.
Tube Fixation Forceps With Atraumatic jaw Parts
Especially Suitable for HLM Tubes for Cardiovascular Surgery
14 cm

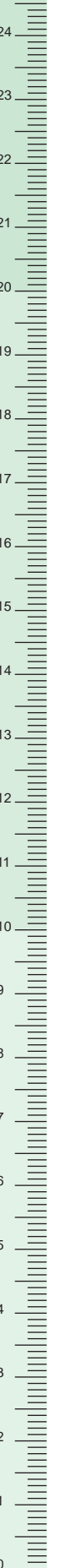

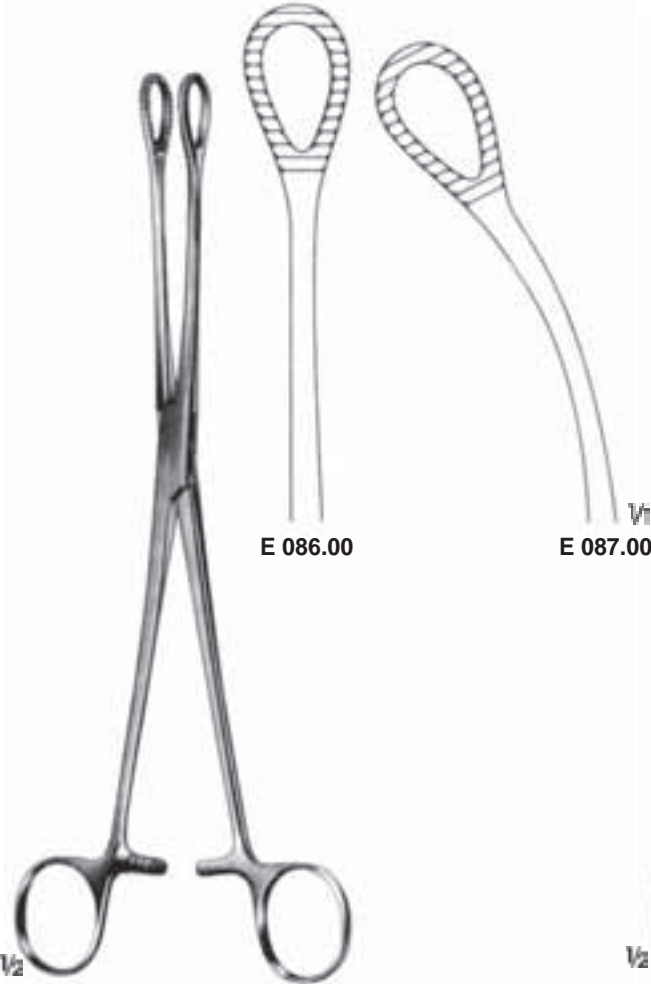

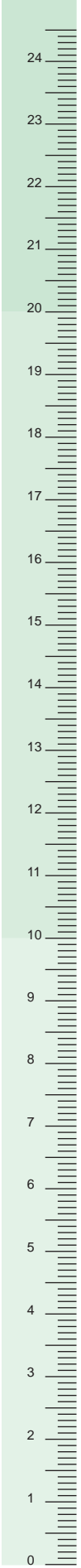

BOYS-ALLIS
E 143.00
 5 X 6 Diş/5 X 6 Teeth
 15.5 cm



ALLIS
E 144.00
 5 X 6 Diş/5 X 6 Teeth
 15.5 cm



ALLIS
E 145.00
 4 X 5 Diş/4 X 5 Teeth
 15.5 cm

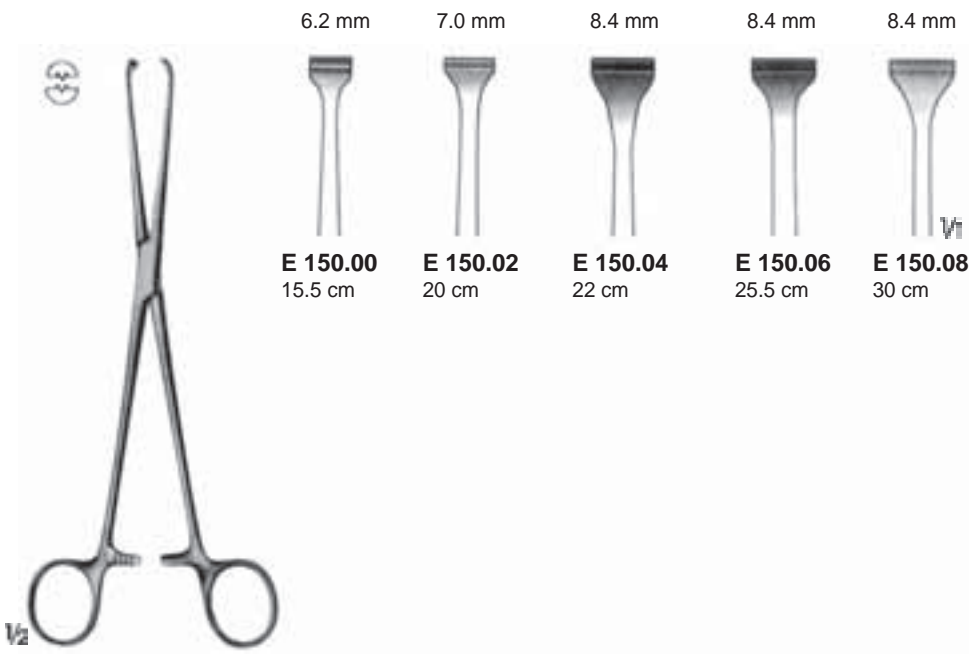

ALLIS
E 150.00-E 150.08



ALLIS
E 147.01
 5 x 6 Diş/5 x 6 Teeth
 19 cm

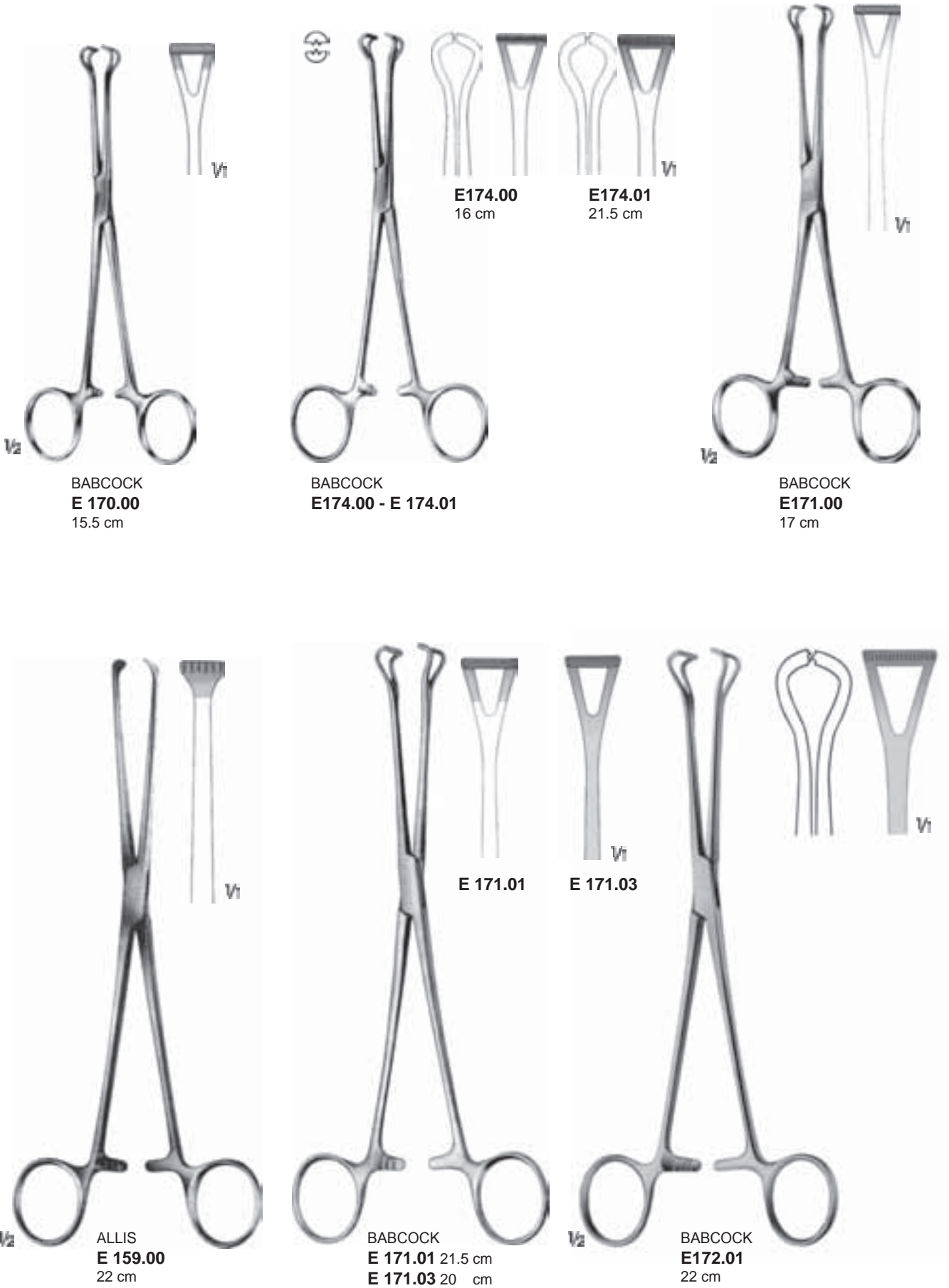

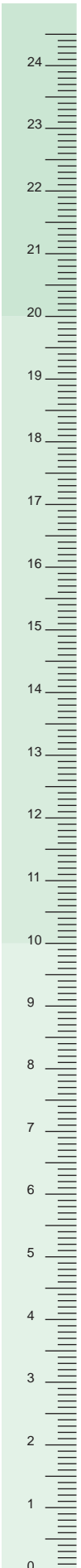
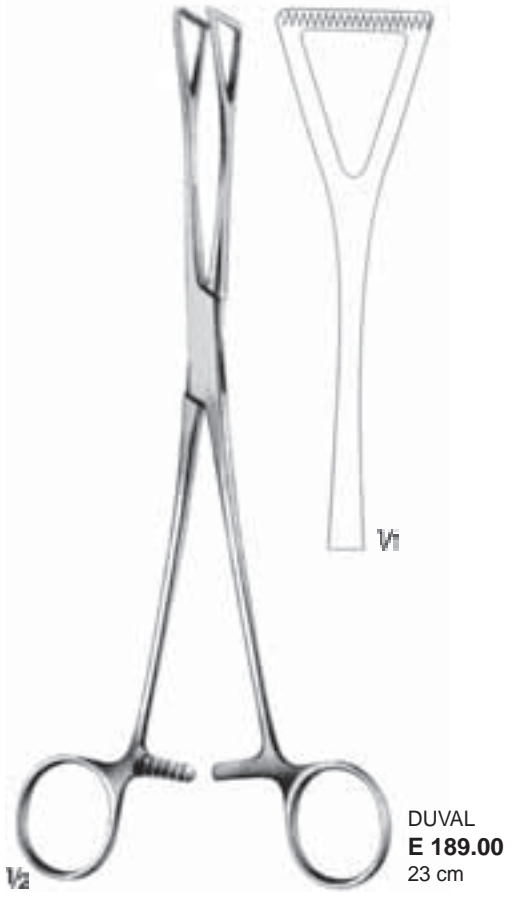
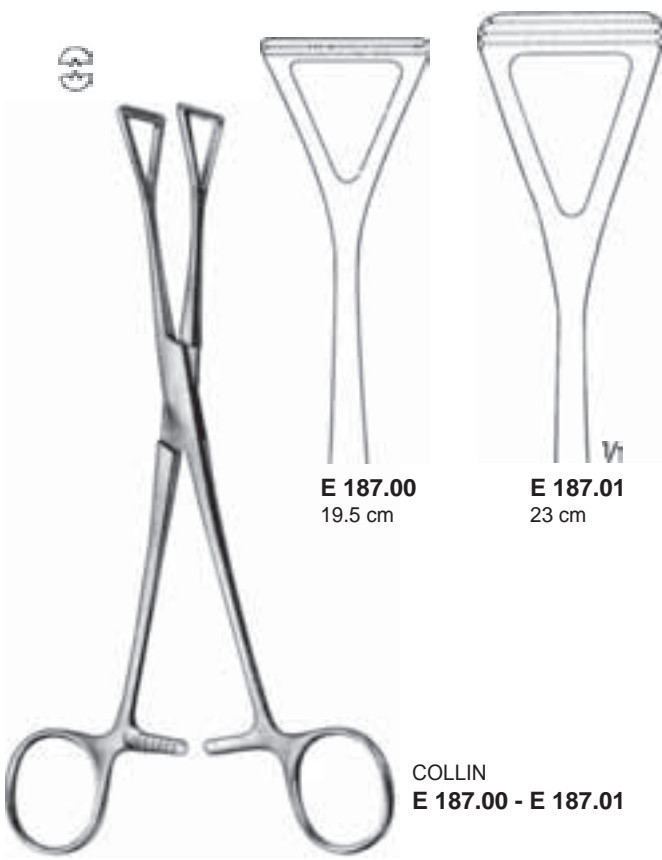
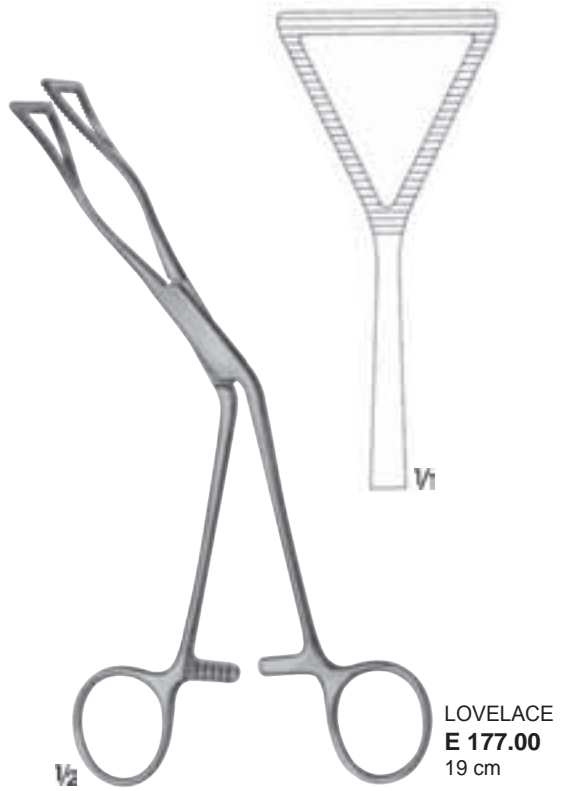
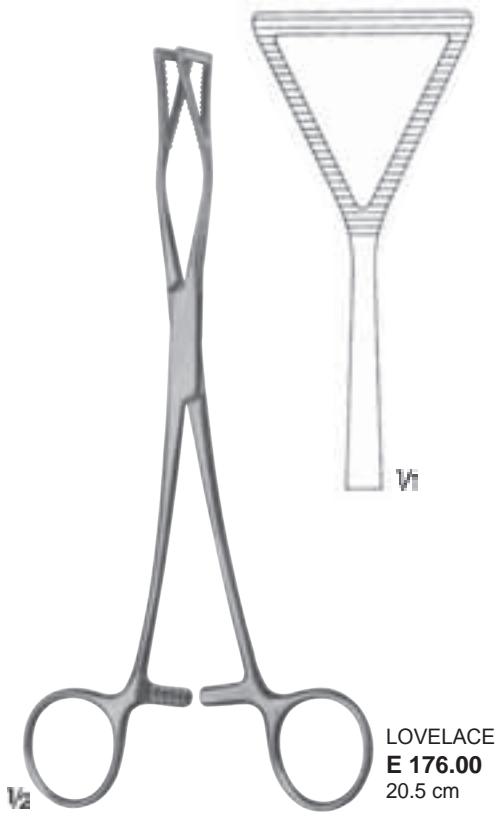

Yuvarlak Saplar

- Parmaklar arasında istenildiği şekilde döndürmeye izin verir.
- Sağlam veya oyulmuş saplardan dolayı her bir alette optimum denge sağlar

Round Handle

- Allows rotation between the fingers as required
- Due to carved and strong handle, each instrument provides optimum balance



Düz Saplar:

Sağlam kavrama özelliği sağlar.

Flat Handles:

Provides a solid grip.



Kavrama yüzeyini artıran hafif plastik tutamak :

- Kramp oluşturmeyen, doğal tutma pozisyonu ve duyarlılık sağlar.
- Yuvarlak tutma kesiti aletin kolay ve düzgün rotasyonunu sağlar. Böylelikle uygulama ve çalışma alanı genişler.
- Pimli tutma profili güvenli tutmayı garanti eder.
- Ergonomik, hafif plastik sap yorulmadan optimum kullanım sağlar.

Lightweigh plastic handles to increase grip surface:

- Provides cramp free, natural holding positions and sensitivity
- Round cross-section of the instrument provides an easy and smooth rotation. Expands the working and application area.
- Retention profile with pin ensures safe gripping.
- Ergonomic, light weight plastic handle provides fatigue free, optimal usage.

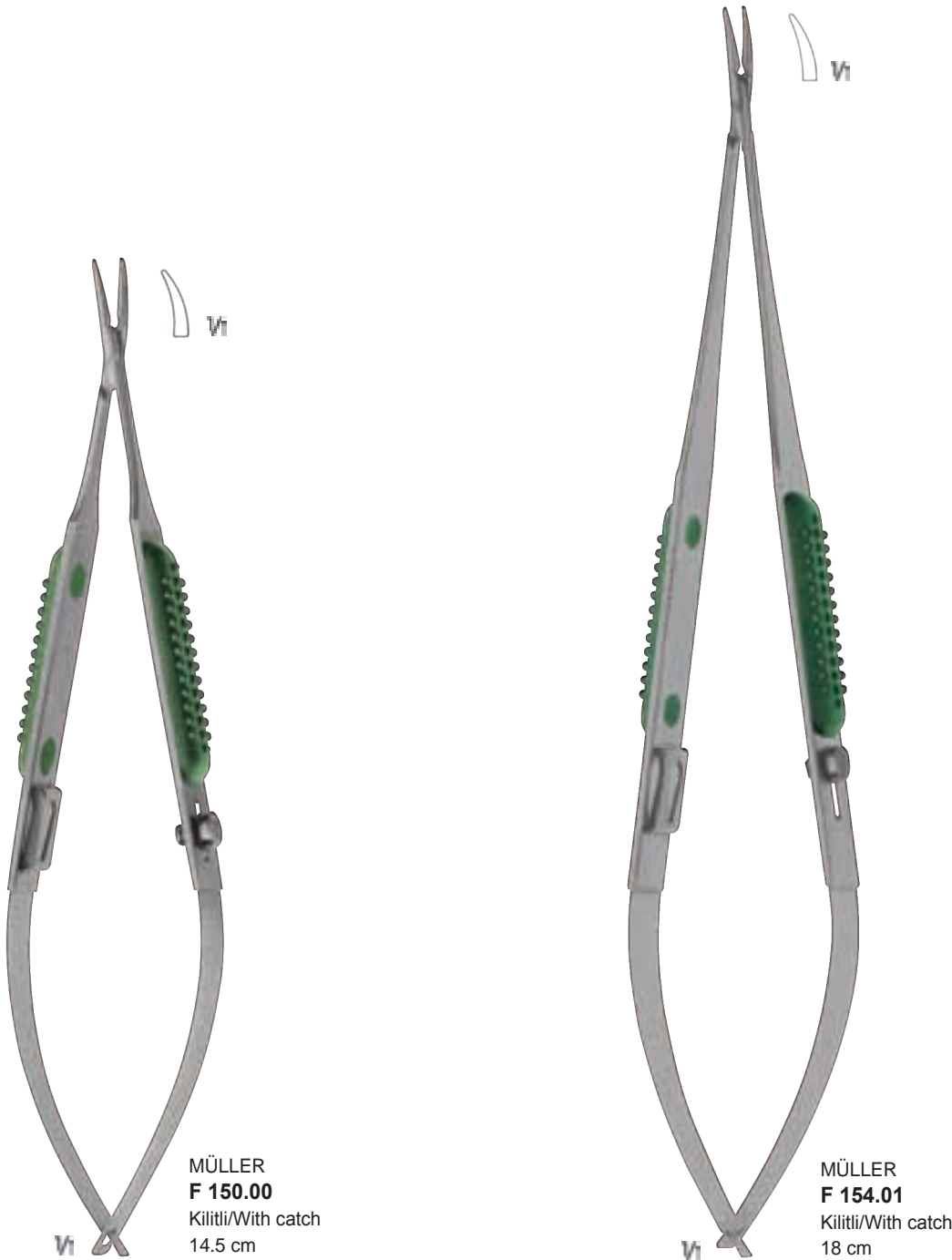

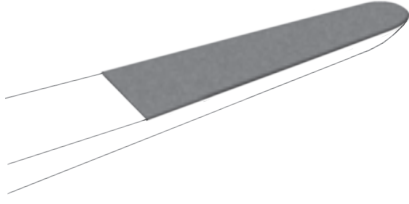

diaMote ağızlar, daha sert ve aşınmaya dayanıklı yüzeyler sağlar.

diaMote ağızlar, hassas iğne, suture ve dokuların güvenilir bir şekilde kavranmasını garanti eder.

diaMote jaws provide harder and more wear resistant surfaces.

diaMote jaws ensure reliable grip of fine needles, sutures and tissues.

Suture 7-0 ve daha küçükler için
For sutures 7-0 and smaller

Suture 5-0 ve daha küçükler için
For sutures 5-0 and smaller

Suture 7-0 ve daha küçükler için
For sutures 7-0 and smaller

Suture 5-0 ve daha küçükler için
For sutures 5-0 and smaller

Suture 4-0 ve daha küçükler için
For sutures 4-0 and smaller

Suture 4-0 ve daha küçükler için
For sutures 4-0 and smaller



12 cm	F 310.01
14.5 cm	-
16 cm	F 310.02
18.5 cm	F 310.03
21 cm	F 310.04
23 cm	F 310.05

F 310.01-F 310.10
Kilitsiz/Without catch



-	-
-	F 310.06
-	F 310.07
-	F 310.08
-	F 310.09
-	F 310.10



12 cm	F 310.21
14.5 cm	-
16 cm	F 310.22
18.5 cm	F 310.23
21 cm	F 310.24
23 cm	F 310.25

F 310.21-F 310.35
Kilimli/With catch



-	-
-	F 310.26
-	F 310.27
-	F 310.28
-	F 310.29
-	F 310.30



-	-
-	-
-	-
-	F 310.31
-	F 310.32
-	F 310.33



-	-
-	-
-	-
-	-
-	F 310.34
-	F 310.35

Suture 2-0 ve daha küçükler için
For sutures 2-0 and smaller



19 cm	F 310.44
23 cm	F 310.46
25 cm	F 310.48

F 310.44 - F 310.48
Kilitsiz/Without catch



Suture 2-0 ve daha küçükler için
For sutures 2-0 and smaller



19 cm	F 310.45
23 cm	F 310.47
25 cm	F 310.49

F 310.45-F 310.49
Kilimli/With catch





Düz Sap / Flat Handle

Sütür 7-0 ve daha küçükler için
For sutures 7-0 and smaller

Sütür 5-0 ve daha küçükler için
For sutures 5-0 and smaller



14.5 cm	-	F 311.03
17 cm	F 311.02	-
18.5 cm	-	F 311.04
21 cm	-	F 311.05
23 cm	-	F 311.06

F 311.02-F 311.06
Kilitsiz/Without catch

Sütür 7-0 ve daha küçükler için
For sutures 7-0 and smaller

Sütür 5-0 ve daha küçükler için
For sutures 5-0 and smaller



14.5 cm	-	F 311.13
17 cm	F 311.12	-
18.5 cm	-	F 311.14
21 cm	-	F 311.15
23 cm	-	F 311.16

F 311.12-F 311.16
Kilitli/With catch

Kanallı Düz Sap / Flat Knurled Handle

Sütür 5-0 ve daha küçükler için
For sutures 5-0 and smaller



18.5 cm	F 311.20
21 cm	F 311.21
23 cm	F 311.22

F 311.20-F 311.22
Kilitsiz/Without catch

Sütür 5-0 ve daha küçükler için
For sutures 5-0 and smaller



18.5 cm	F 311.25
21 cm	F 311.26
23 cm	F 311.27

F 311.25-F 311.27
Kilitli/With catch

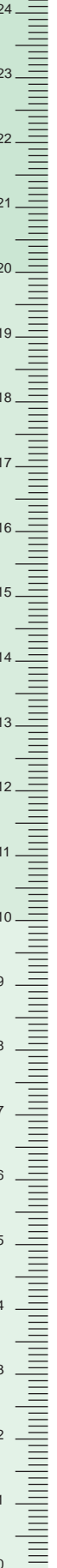

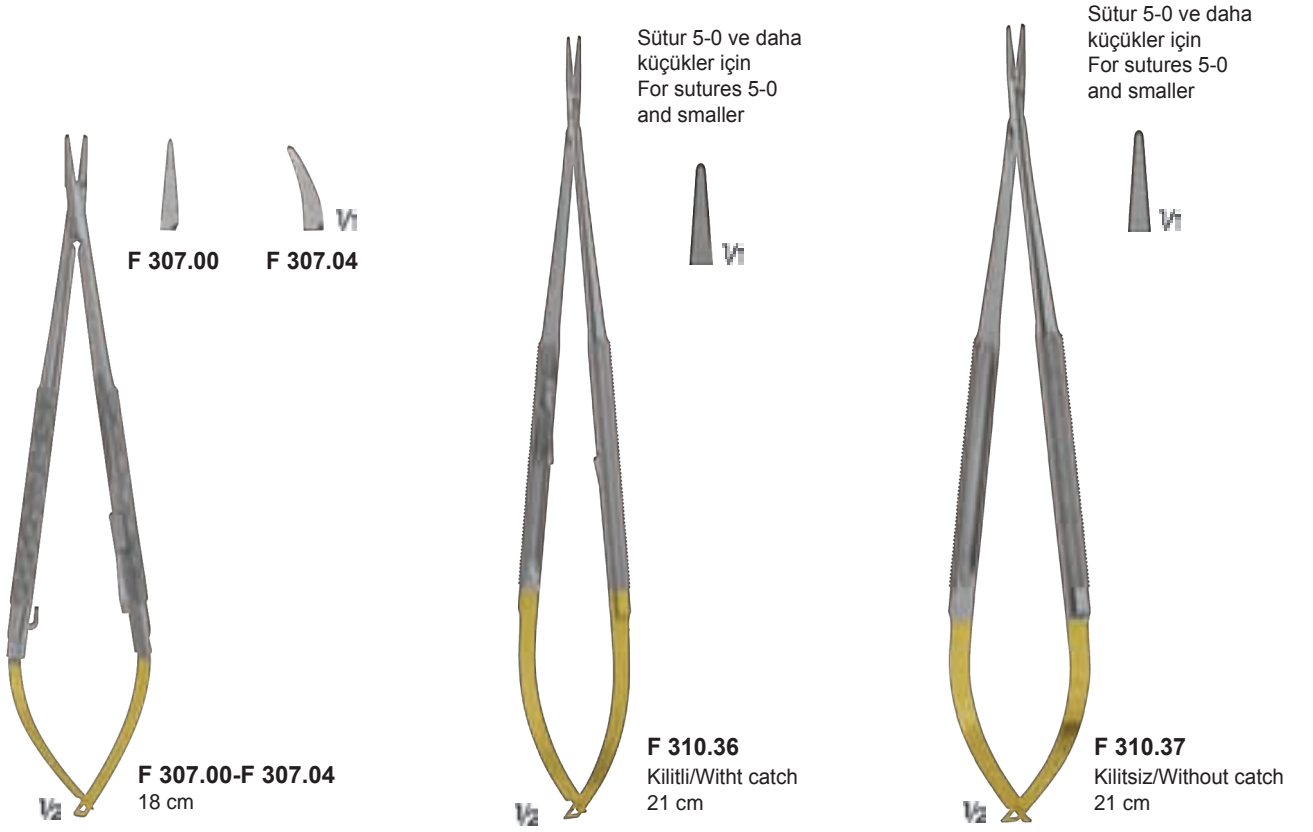

TITANYUM/TITANIUM

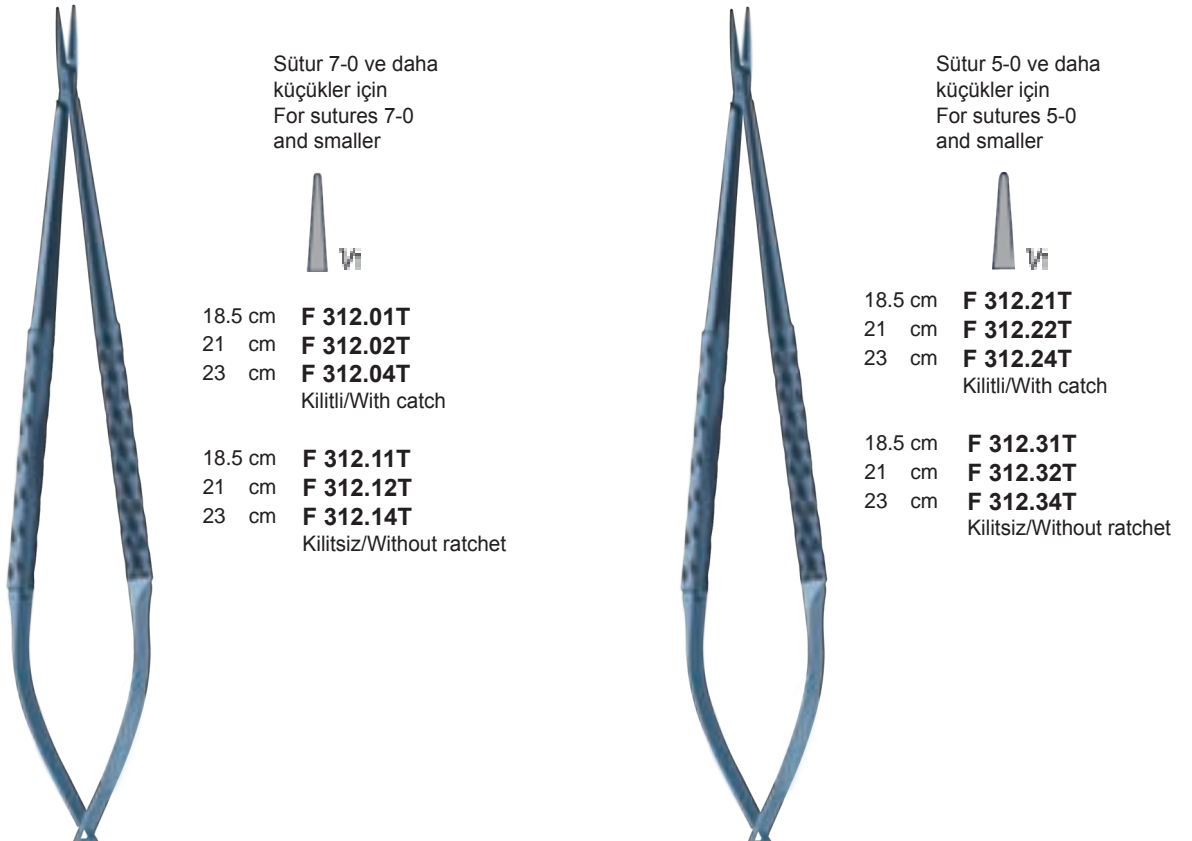

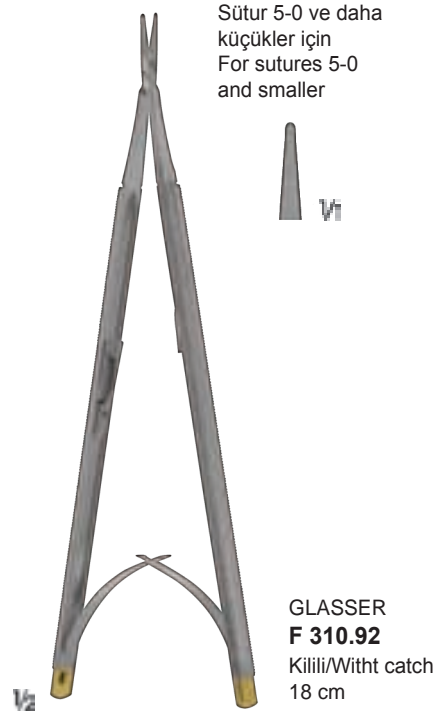

Sütür 5-0 ve daha küçükler için
For sutures 5-0 and smaller

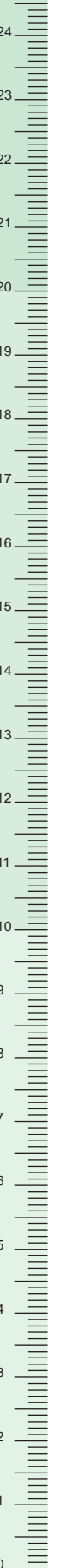
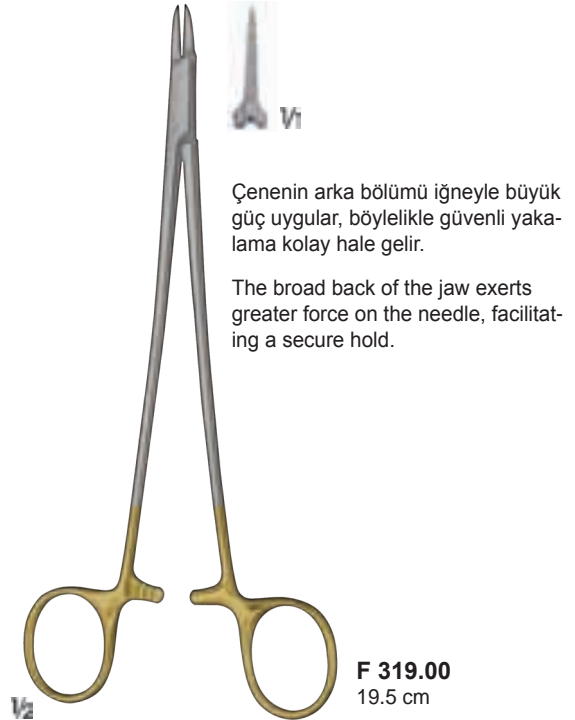
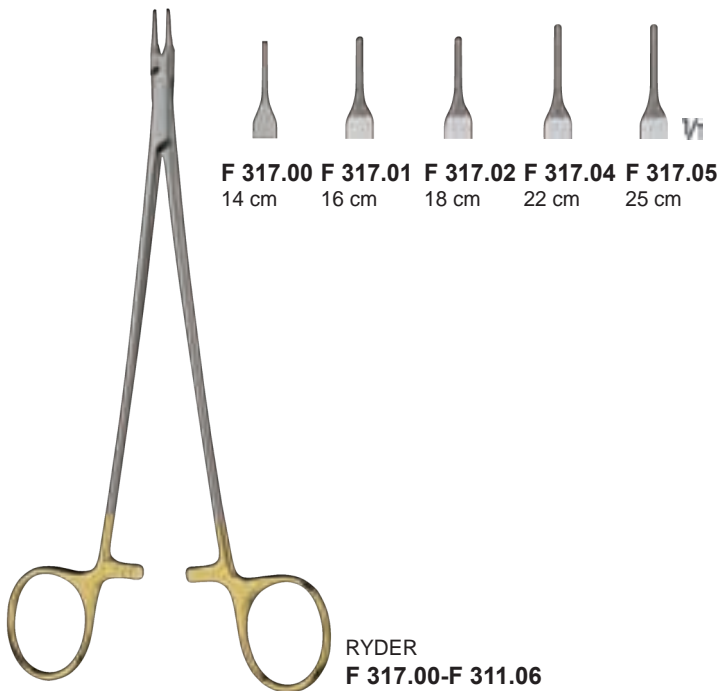

- Cerraha maksimum ergonomik rahatlık sağlar.
- Optimize tasarımları sayesinde zor suture ve anastomoz tekniklerinde yorulmadan çalışmayı sağlar.
- Provides maximum ergonomic comfort to surgeon.
- Due to optimized design, it provides fatigue free working on suture and anastomosis techniques.





CRILE
F 250.00
15 cm



TONNIS
F 251.00
Elastic model/Elastic Pattern
18 cm

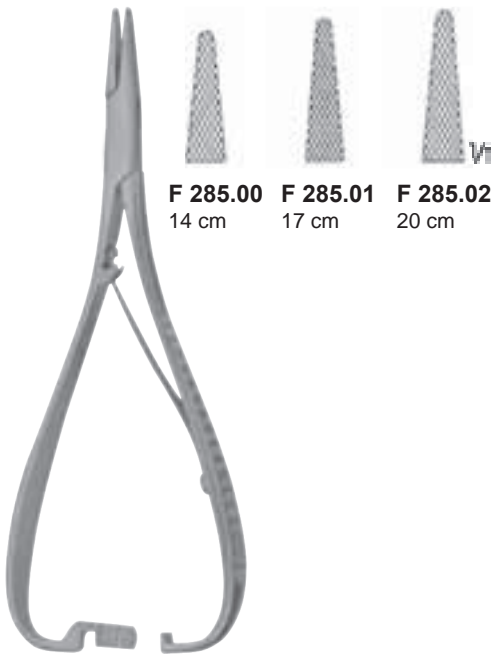

MATHIEU
F 285.00 - F 285.02

F 285.00 14 cm
F 285.01 17 cm
F 285.02 20 cm

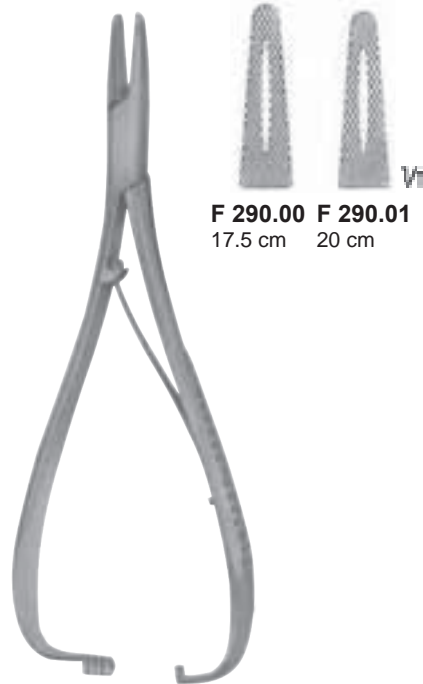

MATHIEU - STILLE
F 290.00 - F 290.01

F 290.00 17.5 cm
F 290.01 20 cm

Çok ağır Model/Wery heavy Pattern



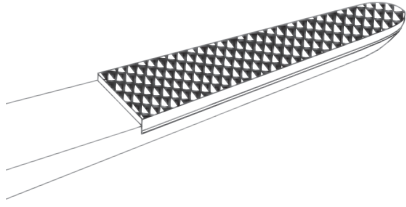

Elmas Uclu Portegüler :

Bahadır Portegülerinin ağızlarındaki elmas uçlarının kullanıma göre yüzey yapısı seçilebilir.

Bahadır elmas uclu portegülerinin 4 farklı yüzeyi vardır. Pürüzsüz yüzey ve 3 farklı çentik yüzeyi uygun iğne yakalamayı sağlar.

Needle holders with carbide inserts.

The carbide inserts on BAHADIR needle holders can be selected based on usage.

BAHADIR needle holders with carbide inserts have four different surface types. Smooth surface and three different notched surfaces provide appropriate needle catch.



Düz
smooth

Pürüzsüz yüzeye sahip ağızlarda kullanılacak, dikiş malzemesi için: 9/0 - 11/0

With smooth jaw surface for suture materials: 9/0 - 11/0



0,2

0.2 mm adımlı çentiğe sahip ağızda kullanılacak, dikiş malzemesi için: 6/0 - 10/0

With 0.2 mm pitch of serration for suture material: 6/0 - 10/0



0,4

0.4 mm adımlı çentiğe sahip ağızda kullanılacak, dikiş malzemesi için: 4/0 - 6/0

0.4 mm pitch of serration for suture material: 4/0 - 6/0



0,5

0.5 mm adımlı çentiğe sahip ağızda kullanılacak, dikiş malzemesi için: 3/0' a kadar

0.5 mm pitch of serration for suture material: up to 3/0



**CASTROVIEJO
F 301.00**
Kilitli/With catch
14.5 cm



**CASTROVIEJO
F 303.00**
Kilitli/With catch
14.5 cm



F 312.00
Kilitli/With catch
17 cm



**CASTROVIEJO
F 305.00 - F 305.01**
Kilitli/With catch
18 cm 21.5 cm

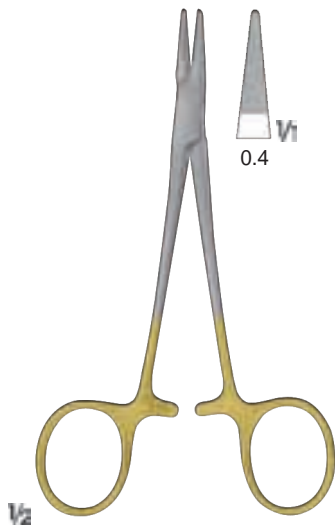

HALSEY
F 325.00
13 cm

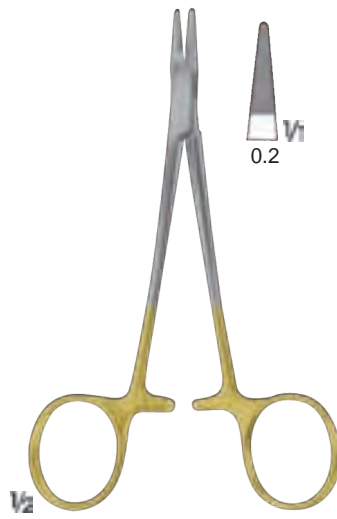

CONVERSE
F 326.00
13 cm

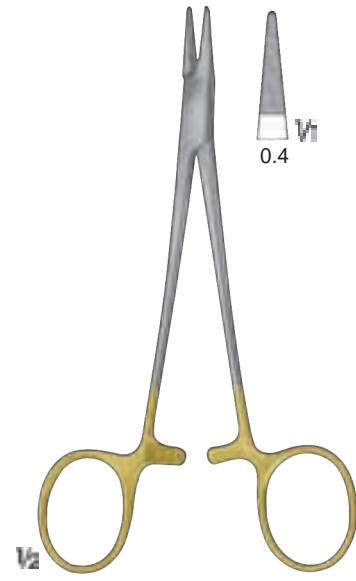

BABY-CRILE-WOOD
F 328.00
15 cm

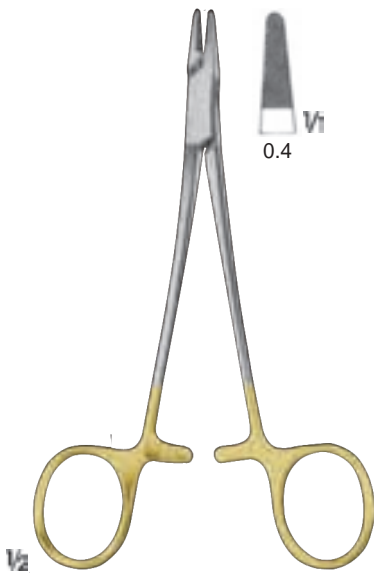

CRILE-WOOD
F 333.00
14.5 cm



HEGAR-MAYO
F 355.00 - F 355.04

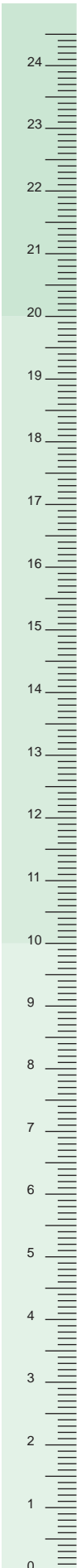
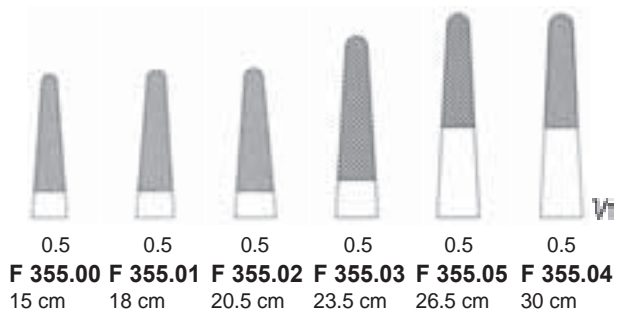



DE BAKEY
F 344.00 - F 345.01
Çok Hassas/Very Delicate

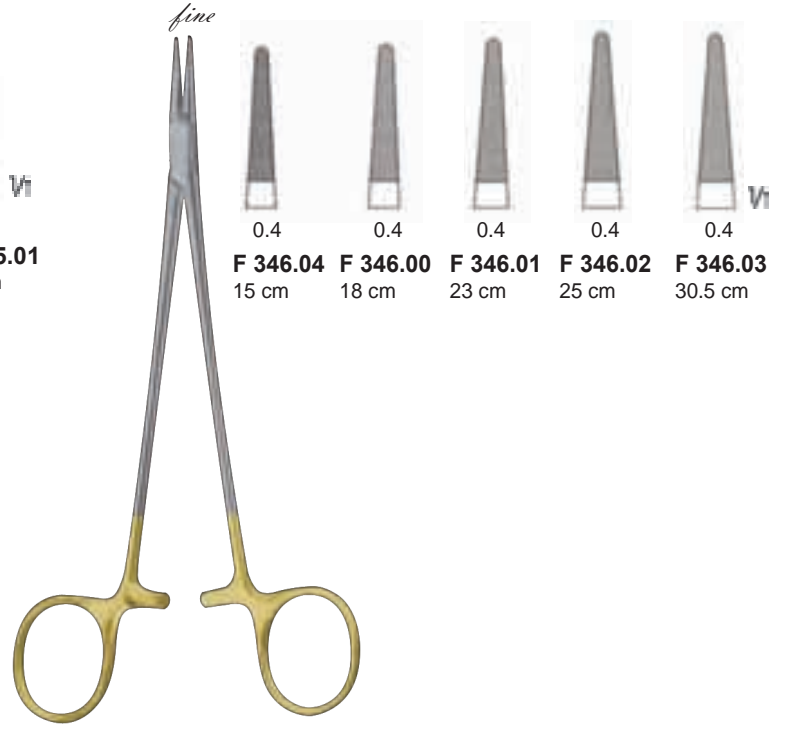

DE BAKEY
F 346.00 - F 346.04



F 347.00 - F 347.02
Çok Hassas/Very Delicate

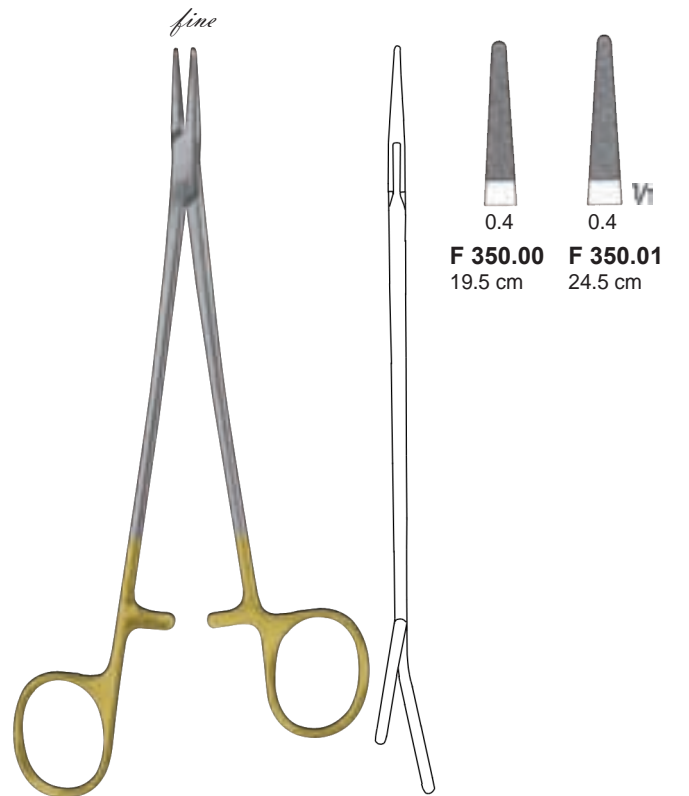

F 350.00 - F 350.01
Uzatılmış bir sap ve kavisli yüzükler,
optimum tutuş sağlar.
One extended handle and curved rings
ensure optimum grip

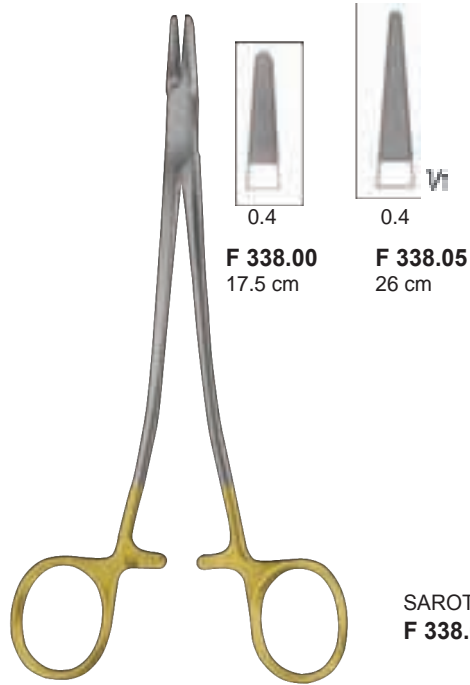

SAROT
F 338.00 - F 338.05



WERTHEIM
F 370.00 - F 370.02

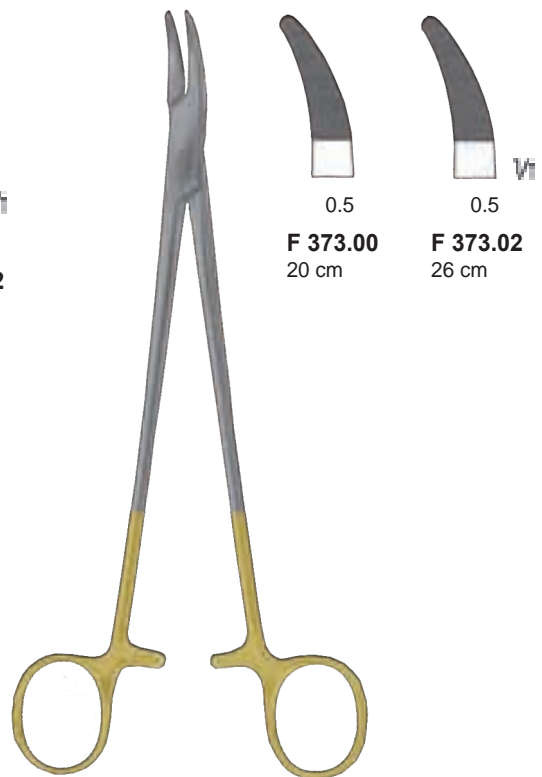

HEANEY
F 373.00 - F 373.02

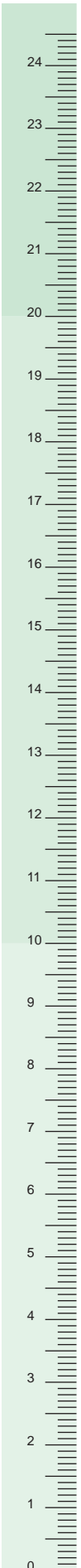



- Cerraha maksimum ergonomik rahatlık sağlar.
- Optimize tasarımları sayesinde zor suture ve anastomoz tekniklerinde yorulmadan çalışmayı sağlar.
- Provides maximum ergonomic comfort to surgeon.
- Due to optimized design, it provides fatigue free working on suture and anastomosis techniques.



REIN-KUPKA
F 382.00
19 cm

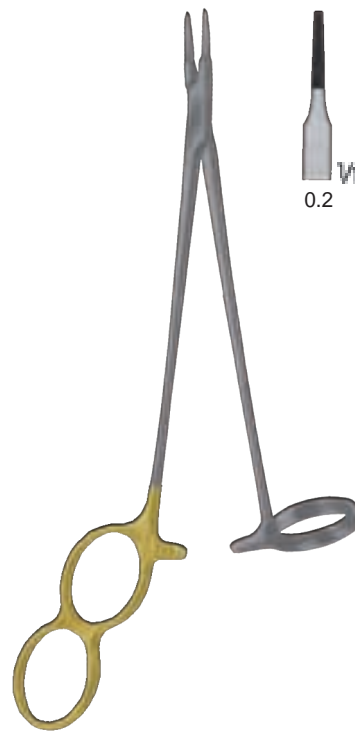

REIN-KUPKA
F 383.00
Kilitli/With catch
19 cm



REIN-KUPKA
F 388.00
21 cm



Hassas çeneler travmatik olmayan ve hassas damar iğneleri tutmak için uygundur.
Fine jaws are suitable for gripping non-traumatic needles and fine vein needles.



fine

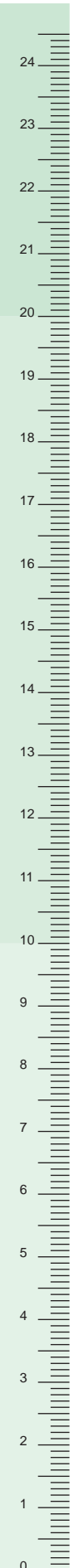
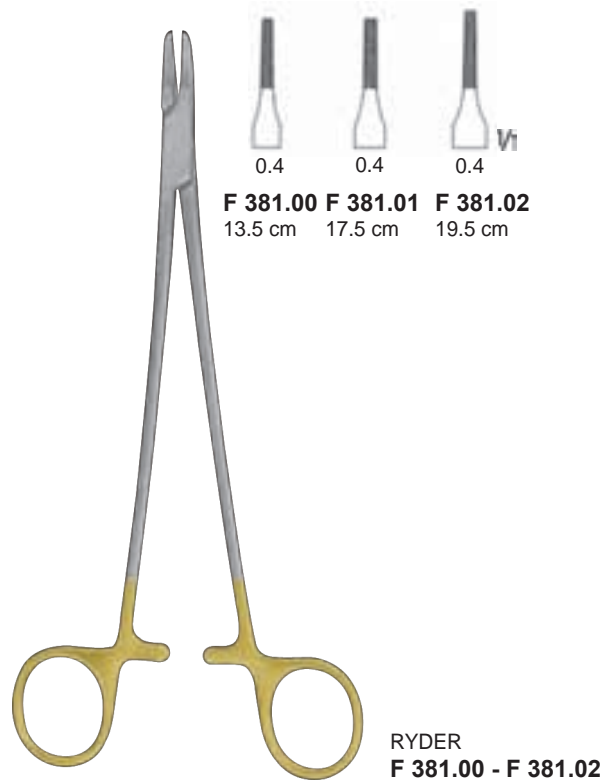
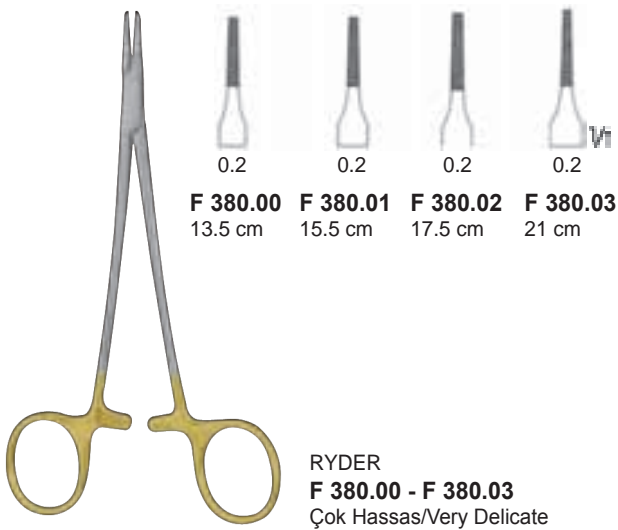



0,5
F 390.00
18 cm
0,5
F 390.01
20 cm

LAHGENBECK
F 390.00 - F 390.01

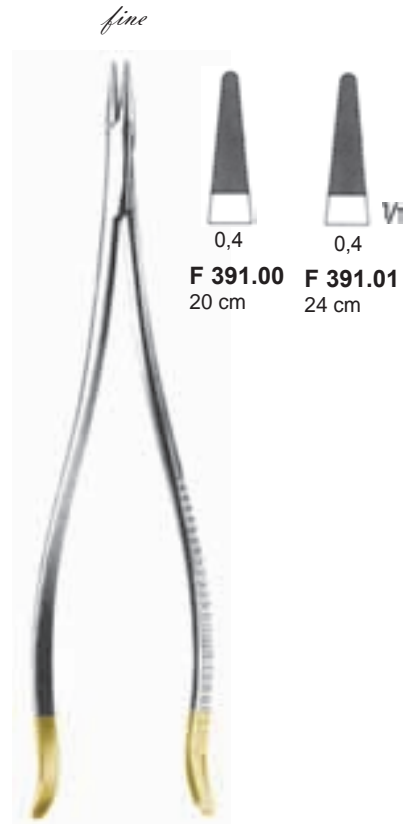

0,4
F 391.00
20 cm
0,4
F 391.01
24 cm

LAHGENBECK
F 391.00 - F 391.01



0,5

TONNIS
F 387.00
Elastik Model/Elastic Pattern
18 cm



0,5

TONNIS
F 384.00
Elastik Model/Elastic Pattern
18 cm



0,4
F 394.00
20.5 cm

0,5
F 394.01
26 cm

F 394.00 - F 394.01



0,5
Vt

LICHTENBERG
F 396.00
Elastik Model/Elastic Pattern
19.5 cm



0,4
F 389.01
14 cm

0,4
F 389.02
17 cm

0,4
F 389.03
20 cm

MATHIEU
F 389.01 - F 389.03
Hassas Model/Delicate Pattern



0,5
Vt

ZWEIFEL
F 399.00
20 cm

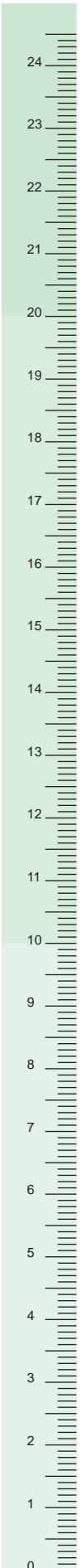

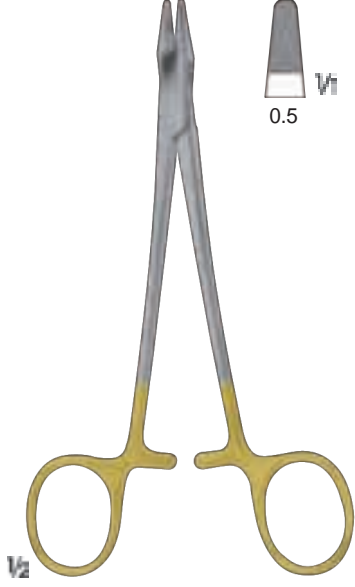

F 334.00
Tel Bükücü/Wire Twister
15 cm



F 336.00
Tel Bükücü/Wire Twister
15 cm

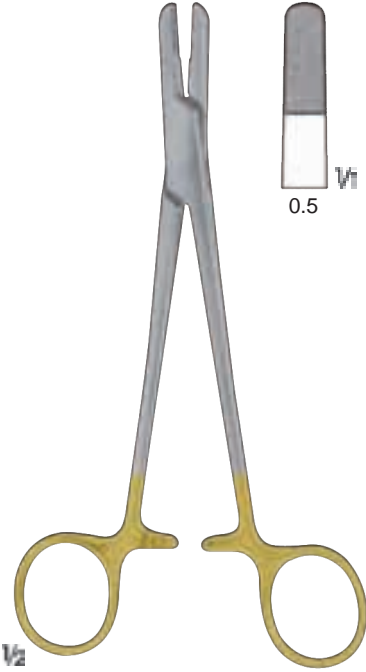

F 337.01
Tel Bükücü
Sternum suture için dikiş pensi
Wire twister
Sternum suture for ligature forceps
17.5 cm



BERRY
F 335.00
Tel Bükücü/Wire Twister
Dikiş Pensi/Ligature Forceps
18.5 cm



BAUMGARTNER
F 339.01
Tel Bükücü/Wire Twister
Dikiş Pensi/Ligature Forceps
20 cm



HEGAR
F 357.00 - F 357.01
Ağır model/Heavy Pattern



WANGENSTEEN
F 360.02
27.5 cm



FINOCHIETTO
F 363.02
26.5 cm

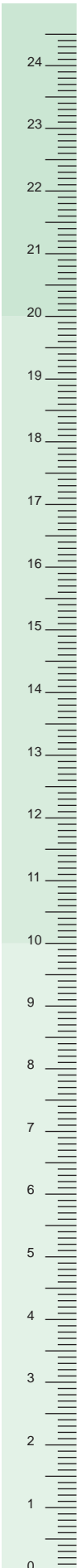

Mikro damar anastomileri için:
Güvenli ve dikkatli şekilde damar kavrama.
Sabitlenmiş baskı mesafeli, tırtıllı yüzeyli bleydler.
Klipsler arası mesafe ayarlanabilir.
Bükerek otomatik sabitleme.

For micro vessel anastomosis:
Safe and careful gripping of vessel.
Blades with serrated surface and rigidly fixed pressure feature.
Adjustable distance between clips.
Automatich fixation by tilling



BIEMER-MULLER
S 010.00
Çene uzunluğu/Lenght of jaws.6 mm
Açıklık/Opening 4 mm
Kapanma Kuvveti/Closing force 30-40 gr.



BIEMER-MULLER
S 011.00
Çene uzunluğu/Lenght of jaws.4.5 mm
Açıklık/Opening 3 mm
Kapanma Kuvveti/Closing force 25-30 gr.



BIEMER-MULLER
S 012.00
Çene uzunluğu/Lenght of jaws.9 mm
Açıklık/Opening 5 mm
Kapanma Kuvveti/Closing force 25-30 gr.



BIEMER-MULLER
S 013.00
Çene uzunluğu/Lenght of jaws.9 mm
Açıklık/Opening 5 mm
Kapanma Kuvveti/Closing force 25-30 gr.



BIEMER-MULLER
S 014.00
Çene uzunluğu/Lenght of jaws.9 mm
Açıklık/Opening 5 mm
Kapanma Kuvveti/Closing force 25-30 gr.



BIEMER-MULLER
S 015.00
Çene uzunluğu/Lenght of jaws.9 mm
Açıklık/Opening 5 mm
Kapanma Kuvveti/Closing force 25-30 gr.

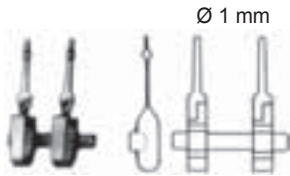

MULLER
S 020.00
Kapanma kuvveti/Closing force. 25-30 gr.

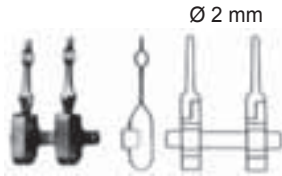

MULLER
S 021.00
Kapanma kuvveti/Closing force. 25-30 gr.

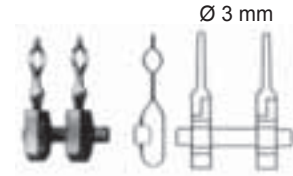

MULLER
S 022.00
Kapanma kuvveti/Closing force. 25-30 gr.

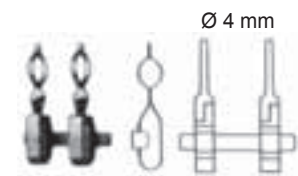

MULLER
S 023.00
Kapanma kuvveti/Closing force. 25-30 gr.



S 030.00
Approximator



BIEMER
S 025.00
Komple Aproksimatör,
anahtarı ile S 029.00 Ap-
proximator, complete
with key S 029.00

Derin aralıkta mikro damar anastomileri için.

- Güvenli ve dikkatli şekilde damar kavrama.
- Tırtıklı yüzeyli bleydler.
- Anahtar ile (S 029.00) basınç ayarı.
- Anahtar ile (S 029.00) klipsler arası mesafenin ayarlanması ve sabitlenmesi.

For micro vessel anastomosis

- Safe and careful gripping of vessel.
- Blades with serrated blade surface
- Pressure adjustment with use of key(S 029.00)
- Adjustment of distance between blades and fixation of blades with a use of key(S 029.00)



BIEMER
S 026.00
Komple Aproksimatör,
anahtarı ile S 029.00
Approximator, complete
with key S 029.00

Sinir anastomilerine güvenli adaptasyon

- Sinir merkezinin, güçlü patolojik değişiklikleri önleyen hassas iğneler ile delinmesi
- Anahtar(S 029.00) kullanımı ile değiştirilebilir iğneler.
- Anahtar ile iğneler arası mesafenin ayarlanması ve sabitlenmesi

Safe adaptation of nerve anastomoses

- Piercing the nerve center with fine needles that prevents strong pathological changes
- Changeable needles with use of key.(S 029.00)
- Adjustment of distance between needles and fixation of needles with use of key(S 029.00)

Geçici damar tıkama için:

Güvenli ve dikkatli şekilde damar kavrama

Sabitlenmiş baskı mesafeli, tırtıklı yüzeyli bleydler

Kapama kuvveti klipsin ağızlarının 1/3 mesafesinde 1 mm aralık durumunda ölçülür.

For temporary occlusion :

Safe and careful gripping of vessel

Blades with serrated surface and rigidly fixed pressure feature

Closing force is measured at 1/3 of the blades a 1 mm opening



BIEMER

S 001.00

Çene Uzunluğu/Lenght of jaws 6 mm

Açıklık/Opening 4 mm

Kapanma Kuvveti/Closing force 30-40 gr. (0.29 - 0.39 N)



S 002.00

Çene Uzunluğu/Lenght of jaws 9 mm

Açıklık/Opening 5 mm

Kapanma Kuvveti/Closing force 30-40 gr. (0.29 - 0.39 N)

BIEMER

S 003.00

Çene Uzunluğu/Lenght of jaws 9 mm

Açıklık/Opening 5 mm

Kapanma Kuvveti/Closing force 20-25 gr. (0.20 - 0.25 N)



for vessel Ø 0.5 - 2.0 mm.

S 034.00 ve S 035.00 ile birlikte kullanılır kullanılır.

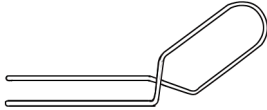

MEHDORN

S 005.00

Çene Uzunluğu/Lenght of jaws 1 mm

Açıklık/Opening 4 mm

Kapanma Kuvveti/Closing force 10-15 gr. (0.10 - 0.15 N)



MEHDORN

S 005.01

Çene Uzunluğu/Lenght of jaws 1.4 mm

Açıklık/Opening 4 mm

Kapanma Kuvveti/Closing force 15-20 gr. (0.15 - 0.20 N)



MEHDORN

S 005.05

Çene Uzunluğu/Lenght of jaws 1 mm

Açıklık/Opening 6 mm

Kapanma Kuvveti/Closing force 10-15 gr. (0.10 - 0.15 N)



MEHDORN

S 005.06

Çene Uzunluğu/Lenght of jaws 1.4 mm

Açıklık/Opening 6 mm

Kapanma Kuvveti/Closing force 15-20 gr. (0.15 - 0.20 N)

for vessel Ø 0.5 - 2.0 mm.

S 032.00 ile birlikte kullanılır.



Vt

BIEMER
S 035.00
Kilitsiz/Without Lock
14.5 cm



Vt

BIEMER
S 034.00
Kilitli/With Lock
14.5 cm



Vt



Vt

BIEMER
S 010.01
Komple/Complete
S 010.00
Sadece aproksimatör
Approximator only
S 024.00 Klip penset
Applying Forceps



Vt

MEHDORN
S 032.00
Applying forceps for MEHDORN
vessel clips
15 cm



Vt

Klipsler çeşitli pozisyonlarda uygun

Various positions of clips possible

Applying forceps for BIEMER vessel clips and BIEMER-MÜLLER and MÜLLER approximators

Applying forceps for BIEMER vessel clips and BIEMER-MÜLLER and MÜLLER approximators

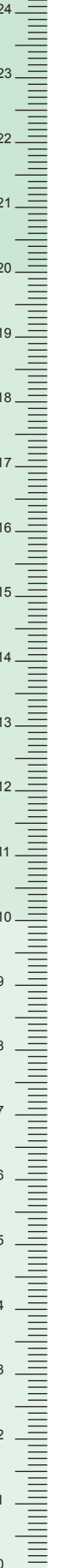

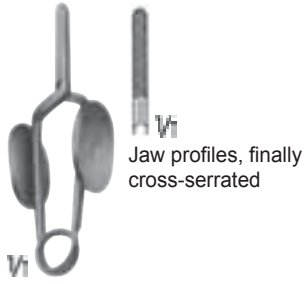

Jaw profiles, finally
cross-serrated

MÜLLER
G 014.00
Dikiş pensisi
Ligature Forceps

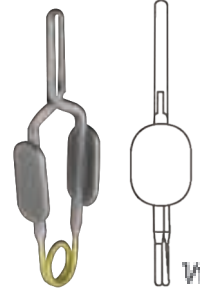

De Bakey Diş



Toothing De BAkey

G 018.00
Atraumatik damar klipi
Tanımlanabilen sabit kapama basıncı 30 gr.
Atraumatic Vessel Clip
Defined, constant closing pressure of 30 gr.

Travmatik olmayan damar klipleri, Geçici / Non-traumatic vessel clips, temporary

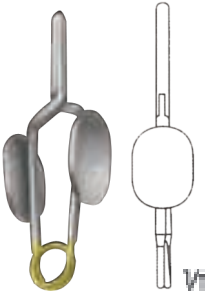

MÜLLER
G 015.00
50 gr, Düz/Straight
Kapama Pensi/Closing Forceps
G 016.00
80 gr, Düz/Straight
Kapama Pensi/Closing Forceps

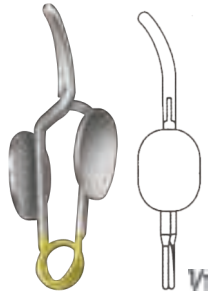

MÜLLER
G 015.05
50 gr, Eğri/Curved
Kapama Pensi/Closing Forceps
G 016.05
80 gr, Eğri/Curved
Kapama Pensi/Closing Forceps

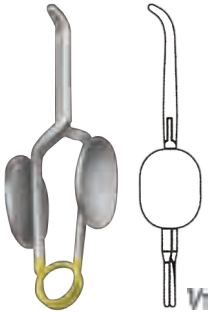

MÜLLER
G 015.10
50 gr, Eğri Curved tips
Closing Forceps
G 016.10
80 gr/ Curved tips
Closing Forceps

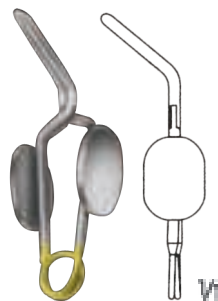

MÜLLER
G 015.15
50 gr/ Angled to side
Closing Forceps
G 016.15
80 gr/ Angled to side
Closing Forceps



MÜLLER
G 015.20
50 gr/ Knee-bent
Closing Forceps
G 016.20
80 gr/Knee-bent
Closing Forceps

Özellikler :

- **Atromatik ağız profili.**
- **Her iki tarafta kullanılan tutma plakaları kliplerin güvenli bir şekilde uygulanması ve çıkarılmasına yardımcı olur.**
- **Atar ve toplar damarlar için kesin olarak tanımlanmış kapama basınçları.**
- **Damar klemplerinin üzerine kapanma basınçları markalanmıştır.**

Features :

- **Atraumatic mouth profile.**
- **Holding plates used on both side of the clips ensure safe application and removal.**
- **Closing pressure of the clips are exactly defined for arterial and venous vessels.**
- **Closing pressure of the clips is marked on the clips.**

De Bakey Diş



Toothing De Bakey



**MÜLLER
H 113.00**
Kapama Kuvveti/Closing Force 250 gr
H 113.01
Kapama Kuvveti/Closing Force 350 gr
Düz/Straight



**MÜLLER
H 114.00**
Kapama Kuvveti/Closing Force 250 gr
H 114.01
Kapama Kuvveti/Closing Force 350 gr
Eğri/Curved



**MÜLLER
H 115.00**
Kapama Kuvveti/Closing Force 250 gr
H 115.01
Kapama Kuvveti/Closing Force 350 gr
Eğri/Curved



**MÜLLER
H 116.00**
Kapama Kuvveti/Closing Force 250 gr
H 116.01
Kapama Kuvveti/Closing Force 350 gr
/Knee-bent



**MÜLLER
H 117.00**
Kapama Kuvveti/Closing Force 250 gr
H 117.01
Kapama Kuvveti/Closing Force 350 gr
Açılı/Angled



DIEFFENBACH
G 020.00 4 cm
Ağız uzunluğu 12 mm
Length of jaws 12 mm
G 020.01 5 cm
Ağız uzunluğu 16 mm
Length of jaws 16 mm



DIEFFENBACH
G 021.00 4 cm
Ağız uzunluğu 12 mm
Length of jaws 12 mm
G 021.01 5 cm
Ağız uzunluğu 16 mm
Length of jaws 16 mm



DIEFFENBACH
G 022.00 6 cm
Ağız uzunluğu 16 mm
Length of jaws 16 mm



DIEFFENBACH
G 023.00 6 cm
Ağız uzunluğu 16 mm
Length of jaws 16 mm



	Toplam Boy Total Length	Ağız uzunluğu Length of jaws
JOHNS-HOPKINS		
G 024.00	38 mm	12 mm
G 024.01	48 mm	17 mm
G 024.02	56 mm	25 mm
G 024.03	63 mm	30 mm
G 024.04	70 mm	33 mm
G 024.05	80 mm	42 mm
G 024.06	91 mm	52 mm



PERTUISET
G 035.00
Karotis Klempli
Carotid Clamp
9 cm



JOHNS-HOPKINS
G 026.00
Buldog klemplerin takılması ve çıkarılması için pens
G 020.00 - G 030.01 ve H 120.00 - H 121.03
Forceps for applying and removing bulldog clamps
G 020.00 - G 030.01 and H 120.00 - H 121.03
24 cm



DIETRICH
G 011.01 - G 011.02
4.5 cm
4 cm



DE BAKEY-HESS
G 030.00 34 mm
Uc Uzunluğu 20 mm
Length of Jaws 20 mm



DE BAKEY-HESS
G 030.01 43 mm
Ağız uzunluğu 30 mm
Length of jaws 30 mm



G 037.00
10 mm



G 037.01
14 mm



G 037.02
18 mm



G 038.00
10 mm



G 038.01
14 mm



G 038.02
18 mm



FEATHERLIGHT

- G 037.00** 3.1 cm
- G 037.01** 3.5 cm
- G 037.02** 3.9 cm
- G 038.00** 3.0 cm
- G 038.01** 3.3 cm
- G 038.02** 3.6 cm



H 130.00



H 131.00



H 130.00 - H 131.00
Ağız uzunluğu 14 cm
Length of jaws 14 cm
3.5 cm



H 130.01
Ağız uzunluğu 19 cm
Length of jaws 19 cm
4.5 cm



H 131.01
Ağız uzunluğu 19 cm
Length of jaws 19 cm
4.5 cm



SHUNT
G 044.00 - G 047.02

- Ø 3.3 mm
- Ø 4 mm
- Ø 4.7 mm



G 044.00
G 044.01
G 044.02
8 cm



G 045.00
G 045.01
G 045.02
8 cm



G 046.00
G 046.01
G 046.02
8 cm



G 047.00
G 047.01
G 047.02
8 cm

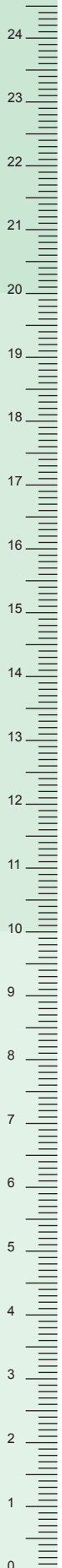

De Bakey Diş



Toothing De BAkey

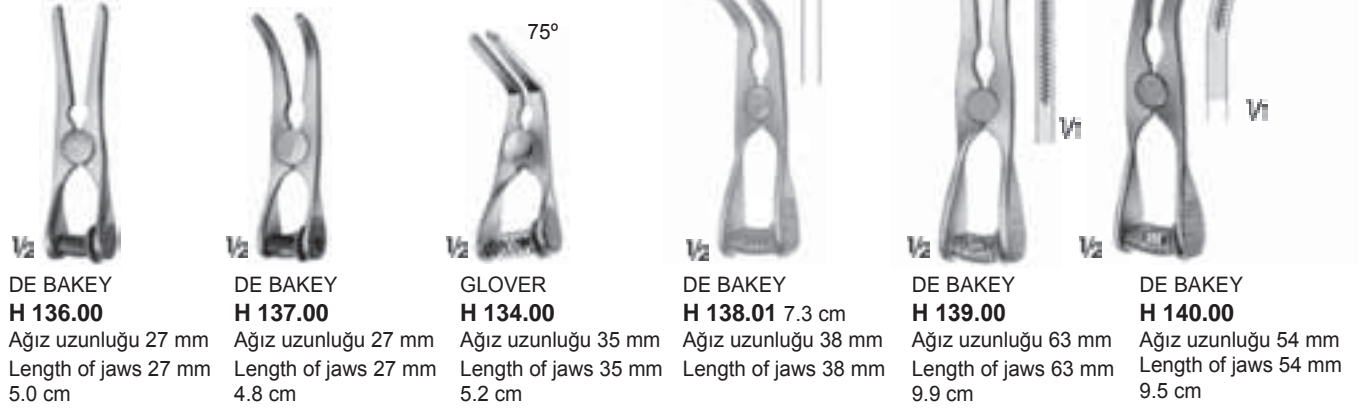

Model	Toplam Boy / Total Length	Ağız uzunluğu / Length of jaws
DE BAKEY H 120.00	8.0 cm	25 mm
DE BAKEY H 120.01	9.0 cm	35 mm
DE BAKEY H 120.02	10.5 cm	50 mm
DE BAKEY H 120.03	12.5 cm	68 mm



Model	Toplam Boy / Total Length	Ağız uzunluğu / Length of jaws
DE BAKEY H 121.00	7.8 cm	23 mm
DE BAKEY H 121.01	8.6 cm	31 mm
DE BAKEY H 121.02	9.7 cm	42 mm
DE BAKEY H 121.03	11.4 cm	58 mm

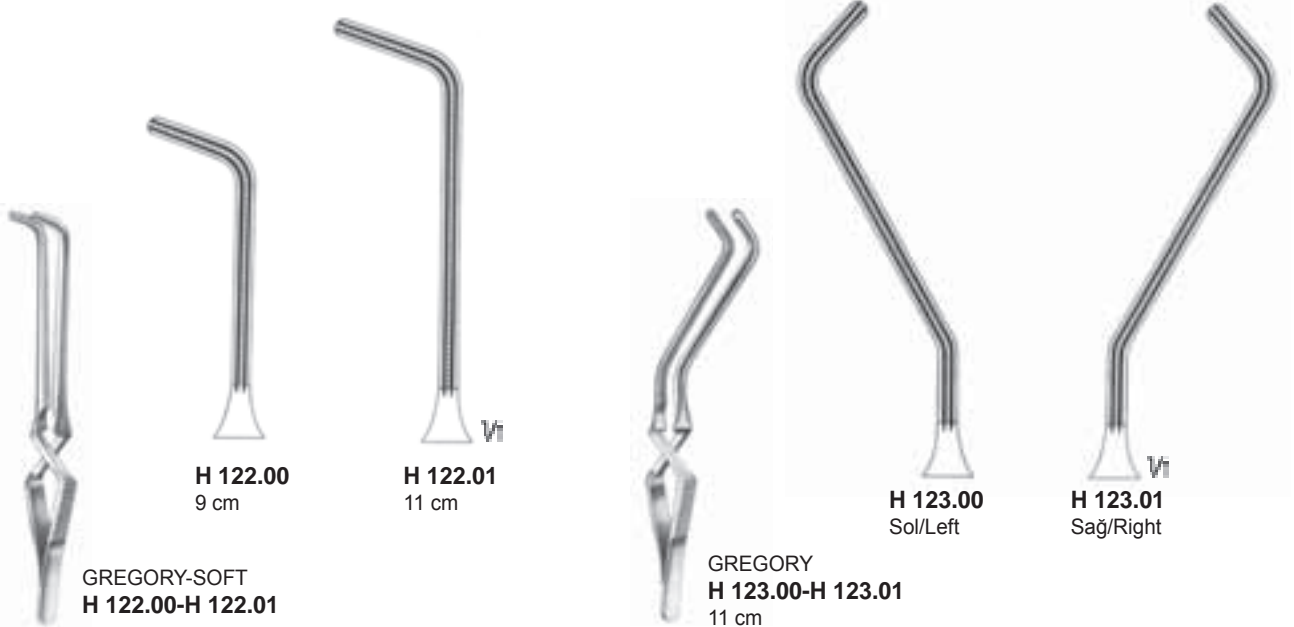

De Bakey Diş



Toothing De BAkey

Kapanma Kuvveti 180 gr.
Closing Force 180 gr.



DE BAKEY
H 105.00

Ağız uzunluğu 1 cm
Length of jaws 1 cm
Düz/Straight
5 cm



DE BAKEY
H 105.02

Ağız uzunluğu 1.4 cm
Length of jaws 1.4 cm
Düz/Straight
5.5 cm



DE BAKEY
H 105.04

Ağız uzunluğu 2 cm
Length of jaws 2 cm
Düz/Straight
6 cm



DE BAKEY
H 106.00

Ağız uzunluğu 2 cm
Length of jaws 2 cm
Eğri/Curved
5.5 cm



DE BAKEY
H 107.00

Ağız uzunluğu 1 cm
Length of jaws 1 cm
Açılı/Angled
5 cm



DE BAKEY
H 107.01

Ağız uzunluğu 1.4 cm
Length of jaws 1.4 cm
Açılı/Angled
5 cm



DE BAKEY
H 107.02

Ağız uzunluğu 2 cm
Length of jaws 2 cm
Açılı/Angled
5.5 cm

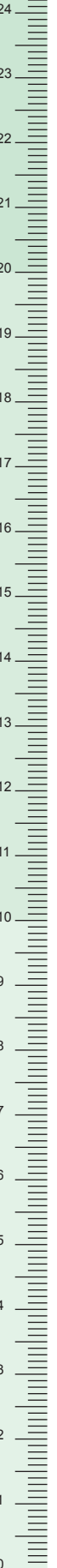

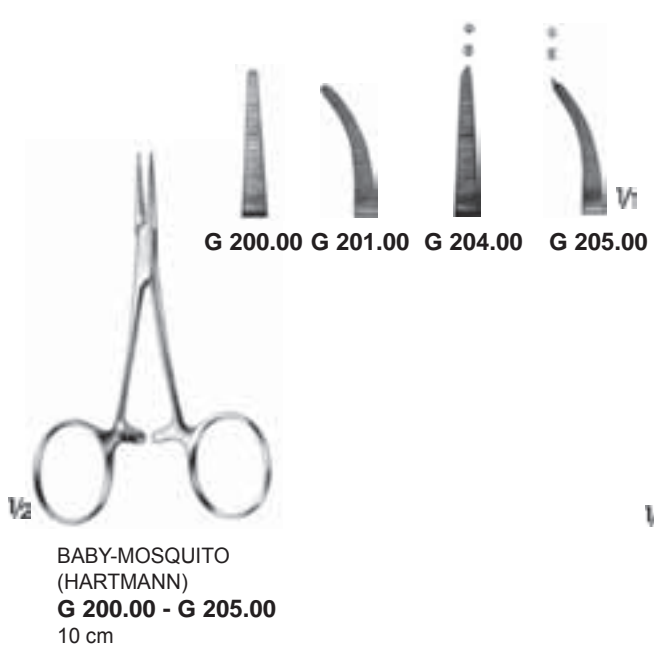

**BABY-MOSQUITO
(HARTMANN)
G 200.00 - G 205.00
10 cm**

G 200.00 G 201.00 G 204.00 G 205.00

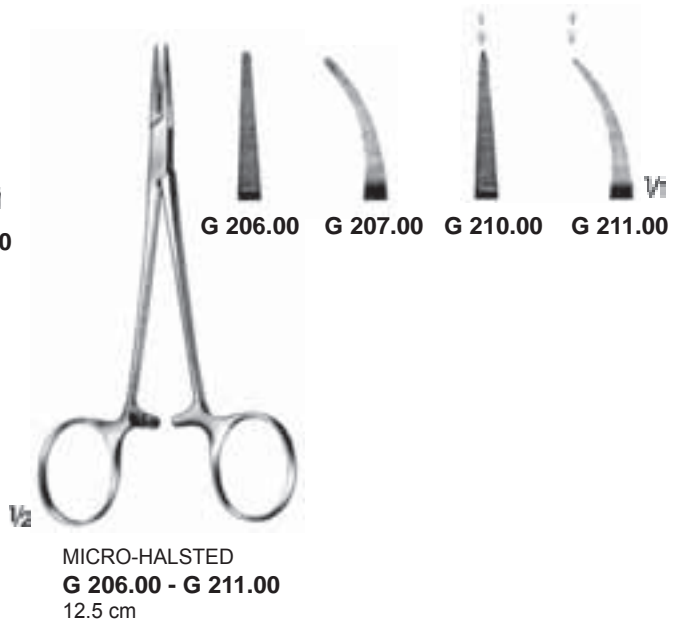

**MICRO-HALSTED
G 206.00 - G 211.00
12.5 cm**

G 206.00 G 207.00 G 210.00 G 211.00



**HALSTED-MOSQUITO
G 214.00 - G 219.00
12.5 cm**

G 214.00 G 215.00 G 218.00 G 219.00

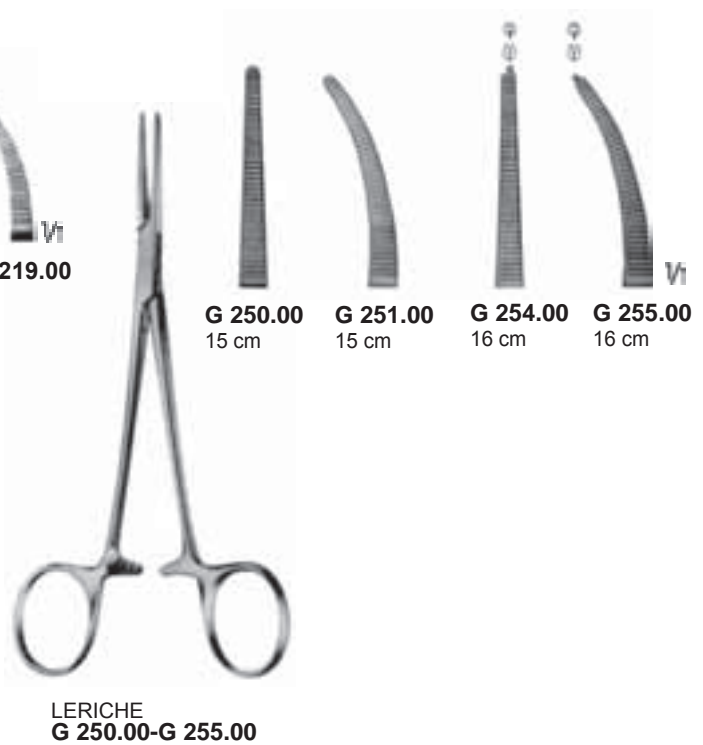

**LERICHE
G 250.00-G 255.00**

G 250.00 15 cm G 251.00 15 cm G 254.00 16 cm G 255.00 16 cm

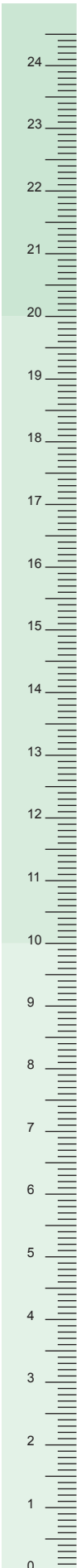

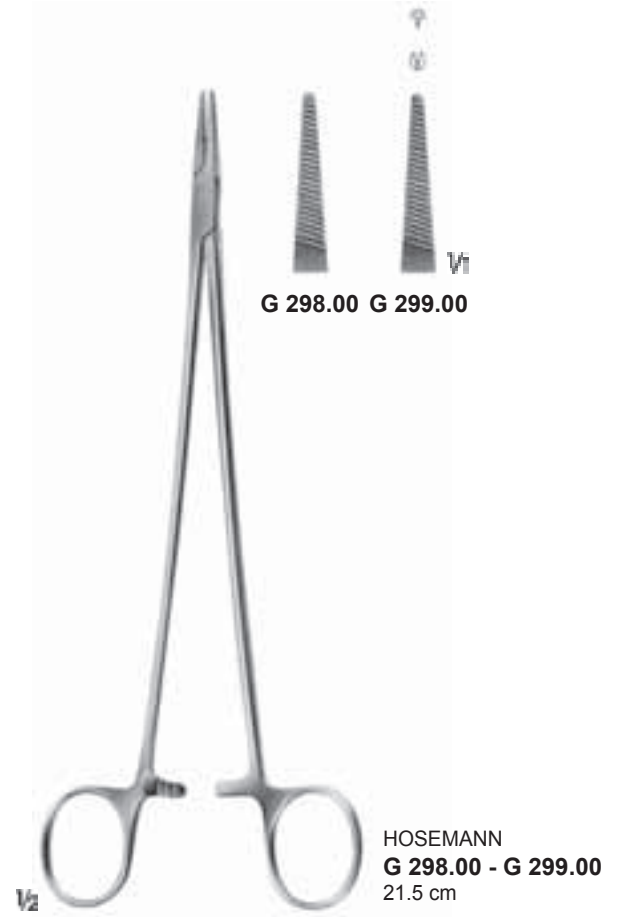
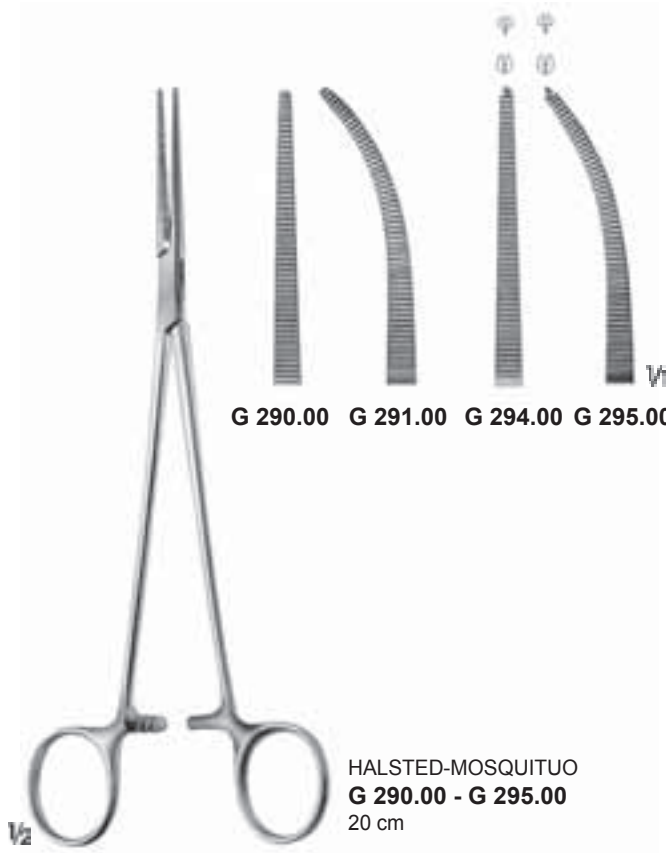



ROBERTS
G 649.00
23 cm



$\frac{1}{2}$
CRAFOORD
G 320.00
24.5 cm



$\frac{1}{2}$
BRIDGE
G 325.00
27.5 cm



BELCHER'S
G 653.00
38 cm

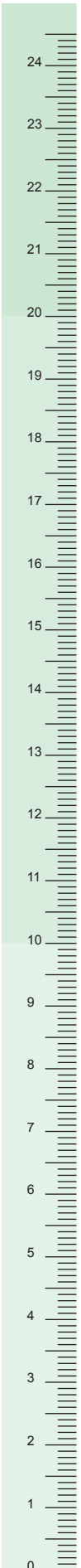

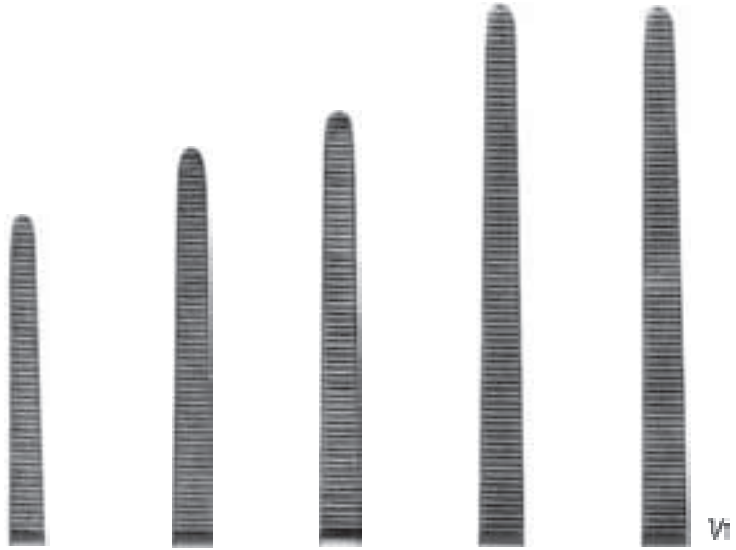

G 430.00
16 cm

G 430.01
18.5 cm

G 430.02
20 cm

G 430.03
22.5 cm

G 430.04
24 cm

Vi



G 431.00
16 cm

G 431.01
18.5 cm

G 431.02
20 cm

G 431.03
22.5 cm

G 431.04
24 cm

Vi



ROCHESTER - PEAN
G 430.00 - G 431.04



Hemostatik Pensler
Hemostatic Forceps

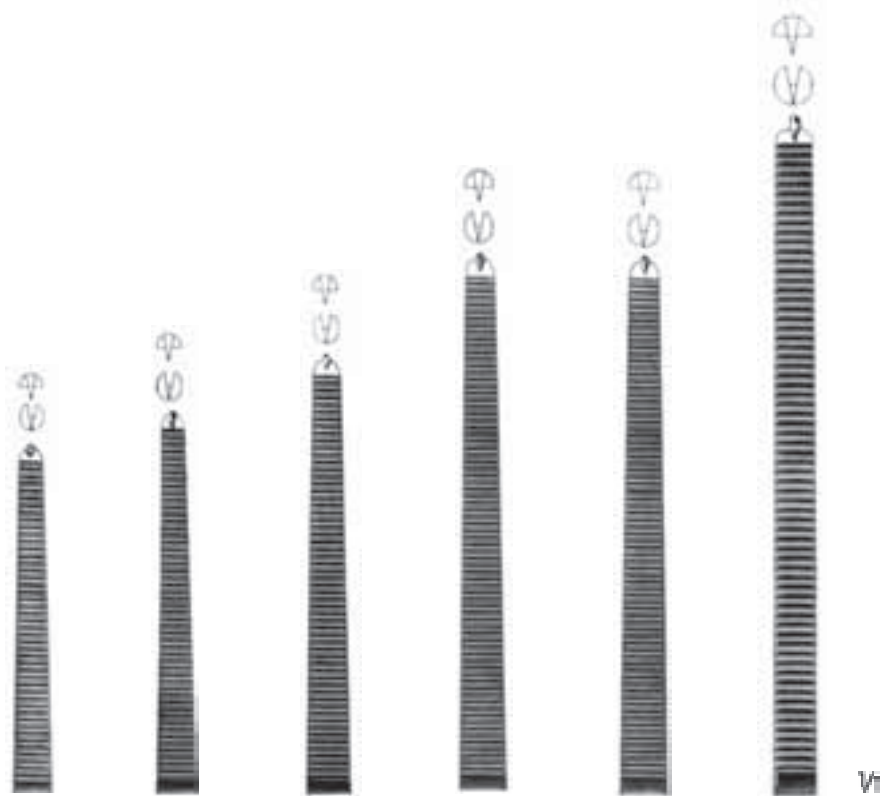

G 448.00
16 cm

G 448.01
18.5 cm

G 448.02
20 cm

G 448.03
22.5 cm

G 448.04
24 cm

G 448.05
26 cm

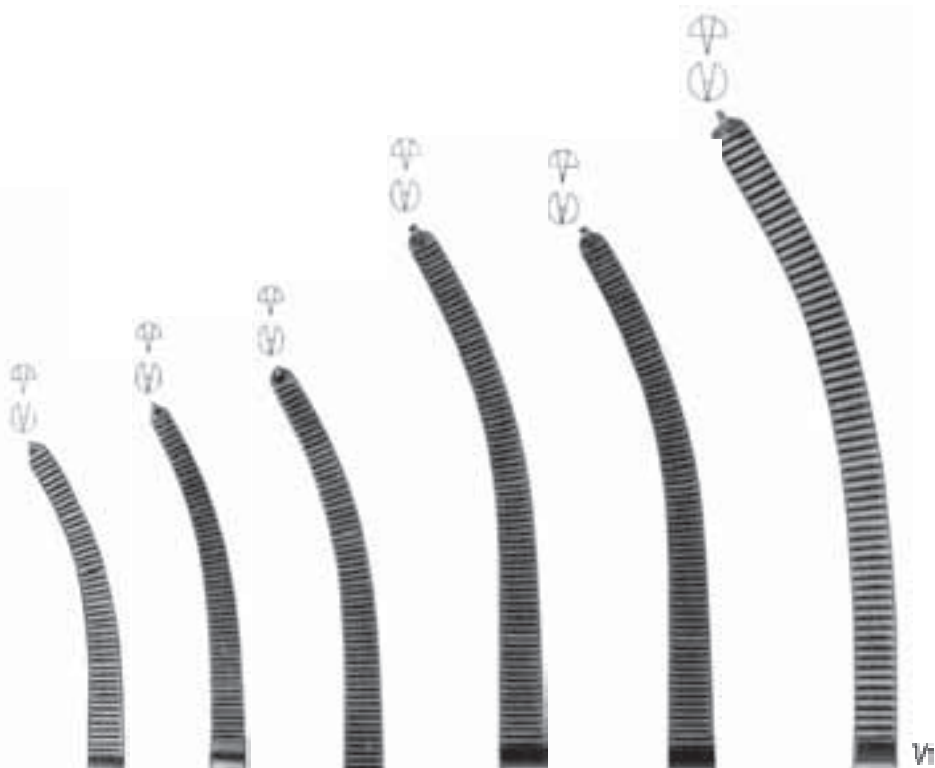

G 449.00
16 cm

G 449.01
18.5 cm

G 449.02
20 cm

G 449.03
22.5 cm

G 449.04
24 cm

G 449.05
26 cm

KOCHER - OCHSNER
G 448.00 - G 449.05



G 610.00
Dikiş Pensi, Düz
Ligature Forcep, Straight
9.5 cm

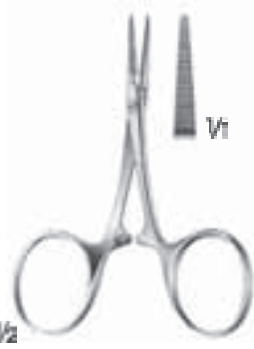

CARREL
G 609.00
Hassas Hemostatik Pens
Delicate Hemostatic Forcep
8.5 cm



MICRO-ADSON
G 614.00
Diseksiyon Pensi
Dissecting Forcep
14 cm



BABY-MIXTER
G 616.00 - G 616.01
Diseksiyon Pensi
Dissecting Forcep

G 616.00 14 cm
G 616.01 18 cm



BABY-ADSON
G 617.00
Diseksiyon Pensi
Dissecting Forcep
14 cm



G 618.00 - G 618.03
Diseksiyon Pensi
Dissecting Forcep
S Şekilli, Hassas
S-Shaped, Delicate

G 618.00 18.5 cm
G 618.01 21 cm
G 618.02 21.5 cm
G 618.03 22 cm

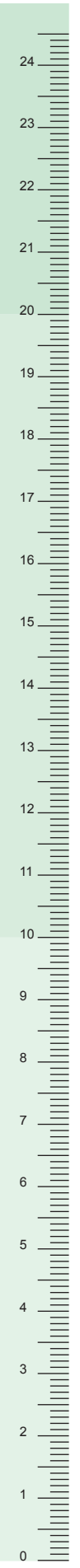





G 620.00
19.5 cm

G 620.01
21 cm

G 620.02
22 cm

G 620.03
22.5 cm

G 620.04
21cm

G 620.05
23 cm

G 620.06
22.5 cm

OVERHOLT - GEISSENDOERFER
G 620.00 - G 620.06
Diseksiyon ve Dikiş Pensleri
Dissecting and Ligature Forceps

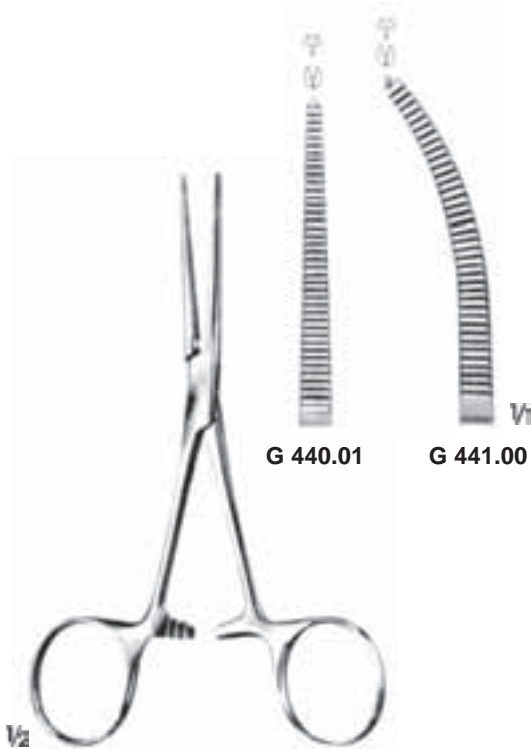

G 440.01

G 441.00

1/2

KOCHER
G 440.01 - G 441.00
Hemostatik Pensler
Hemostatic Forceps
14 cm



G 642.00
18 cm

G 642.01
22 cm

G 642.02
25 cm

G 642.03
28 cm

MINI-GEMINI
G 642.00 - G 642.03
Diseksiyon ve Dikiş Pensleri
Dissecting and Ligature Forceps

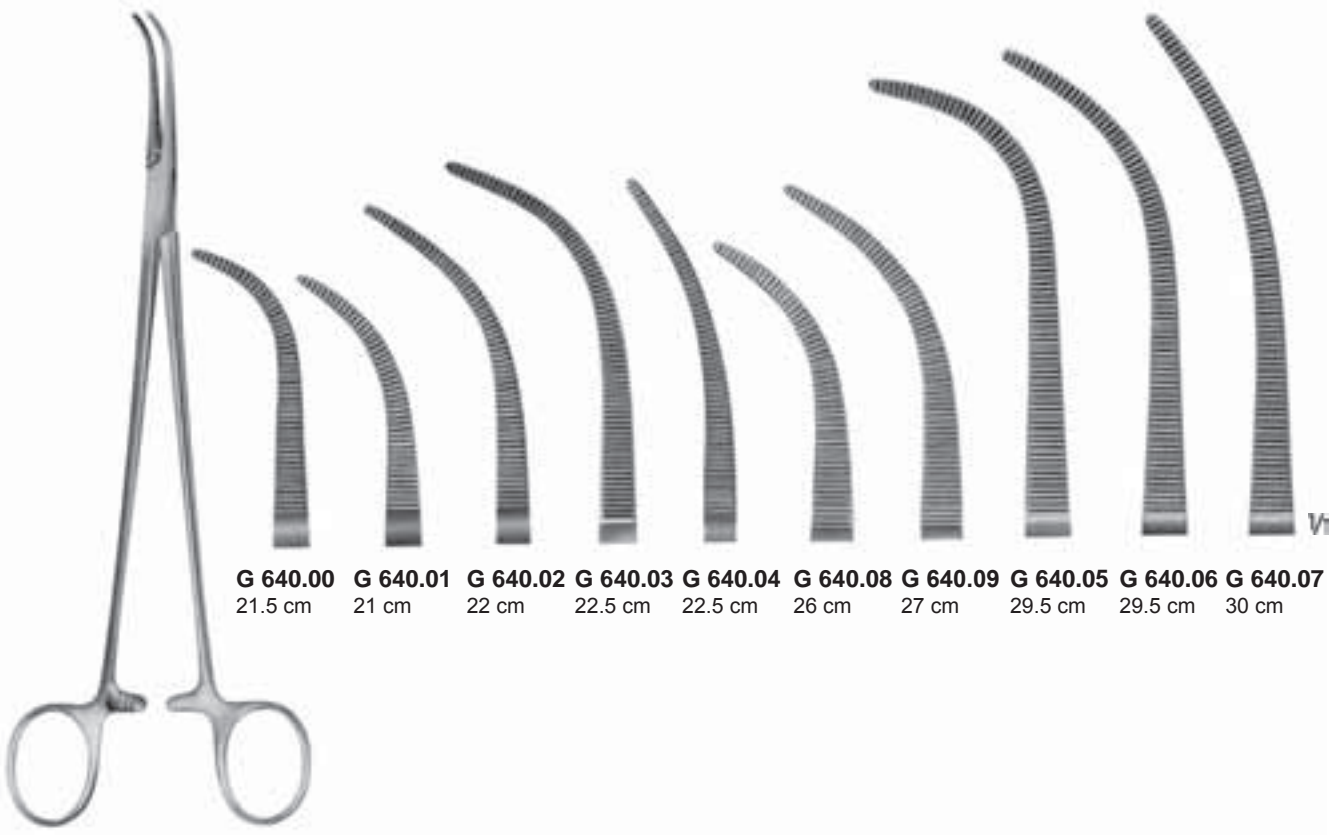

G 640.00	G 640.01	G 640.02	G 640.03	G 640.04	G 640.08	G 640.09	G 640.05	G 640.06	G 640.07
21.5 cm	21 cm	22 cm	22.5 cm	22.5 cm	26 cm	27 cm	29.5 cm	29.5 cm	30 cm

OVERHOLT
G 640.00-G 640.07



MIXTER-O'SHAUGHNESSY
G 650.00
19 cm



WIKSTROEM
G 651.00
20.5 cm



MIXTER
G 654.00
23 cm

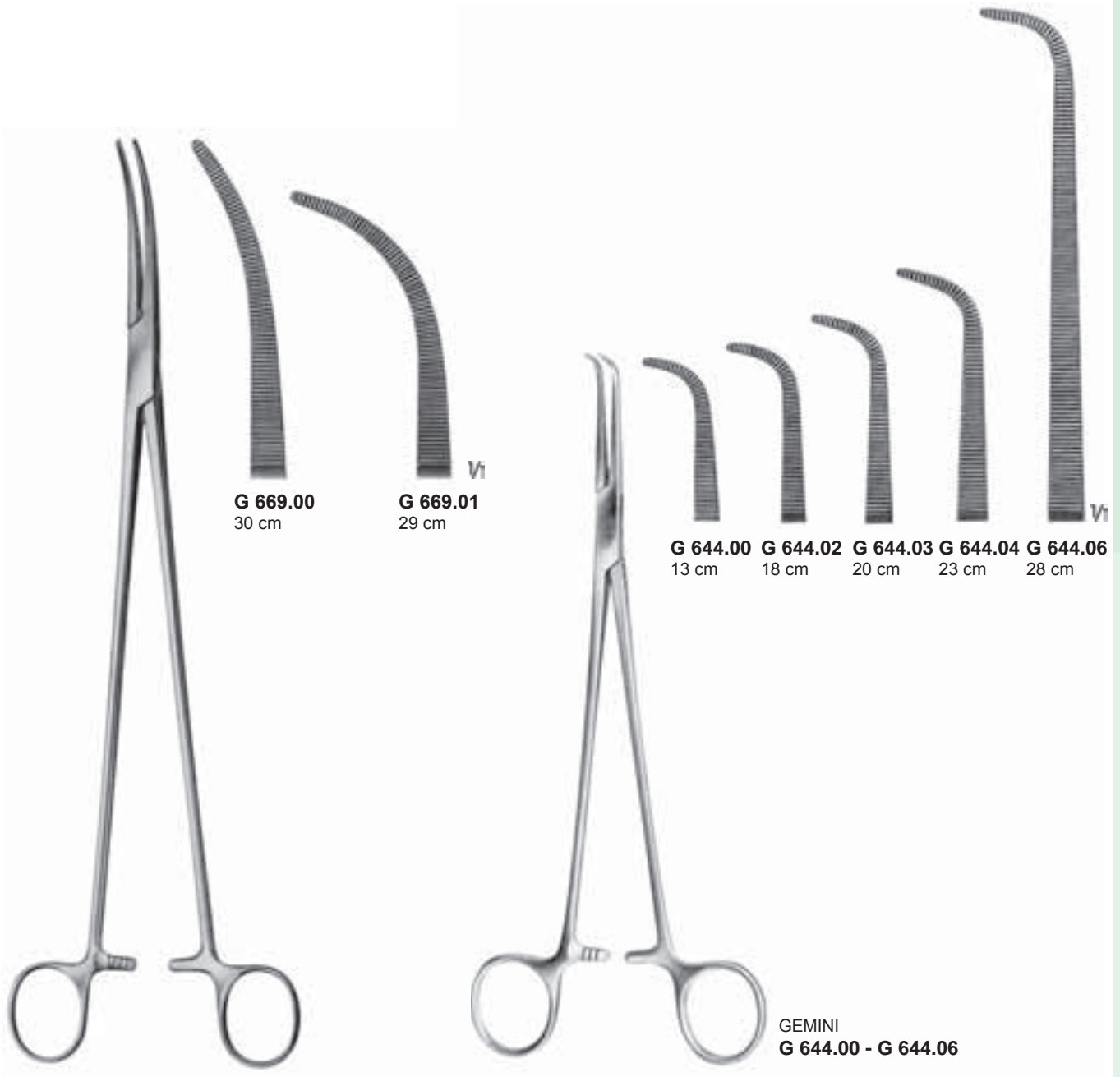

ZENKER
G 669.00 - G 669.01

GEMINI
G 644.00 - G 644.06



RUMEL
G 658.00-G 658.04
24 cm



LAWRENCE
G 664.00
27 cm



G 883.00
Tüp klemp, ağızları tırtılsız
Tubing clamp forceps smooth jaws
16.5 cm



G 784.00 15 cm
G 784.02 18 cm
G 784.03 19 cm
G 784.04 20 cm

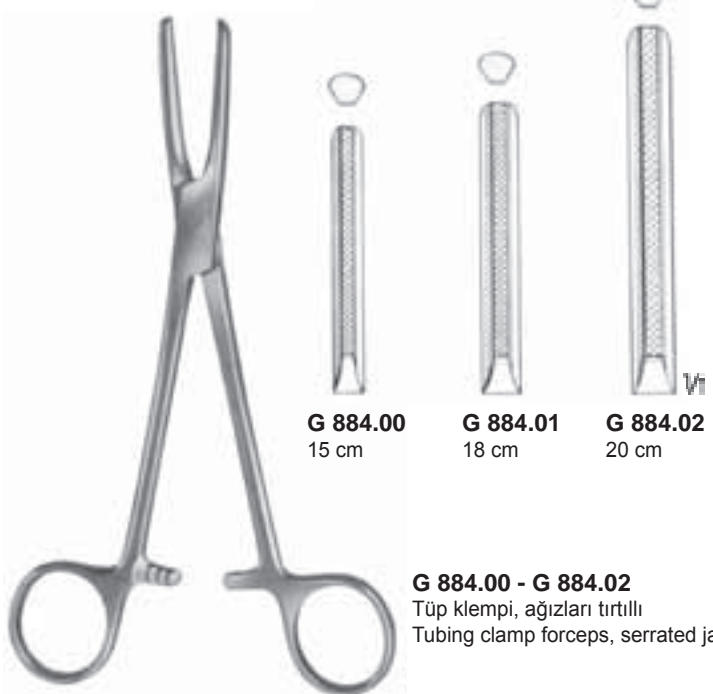

G 884.00
15 cm

G 884.01
18 cm

G 884.02
20 cm

G 884.00 - G 884.02
Tüp klemp, ağızları tırtıllı
Tubing clamp forceps, serrated jaws

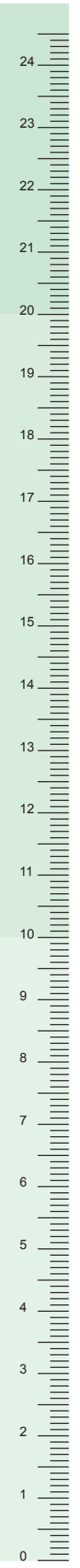



G 458.00
18 cm
G 458.02
24 cm



G 458.05
18 cm



G 458.06
18 cm



G 458.08
11.5 cm

BAILEY-OCHSNER
G 458.00 - G 458.08



HILUS-PULMONIS
G 453.00
20 cm

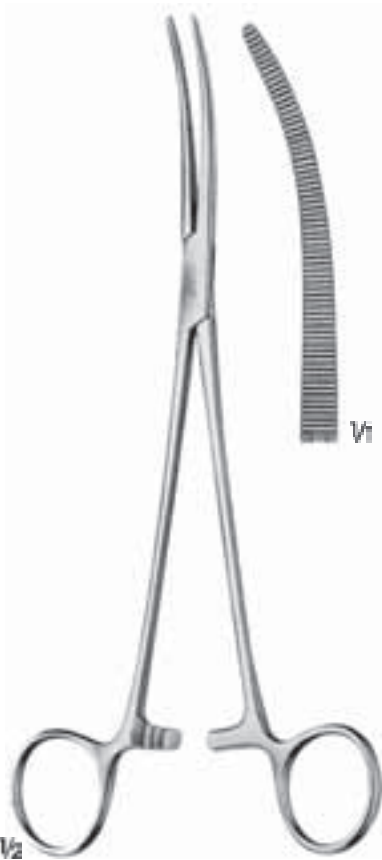

ROBERTS
G 425.00
22 cm



JACOBSEN
G 452.00 - G 451.06



G 452.00
13 cm



G 452.01
13 cm



G 452.05
19 cm



G 452.06
19 cm

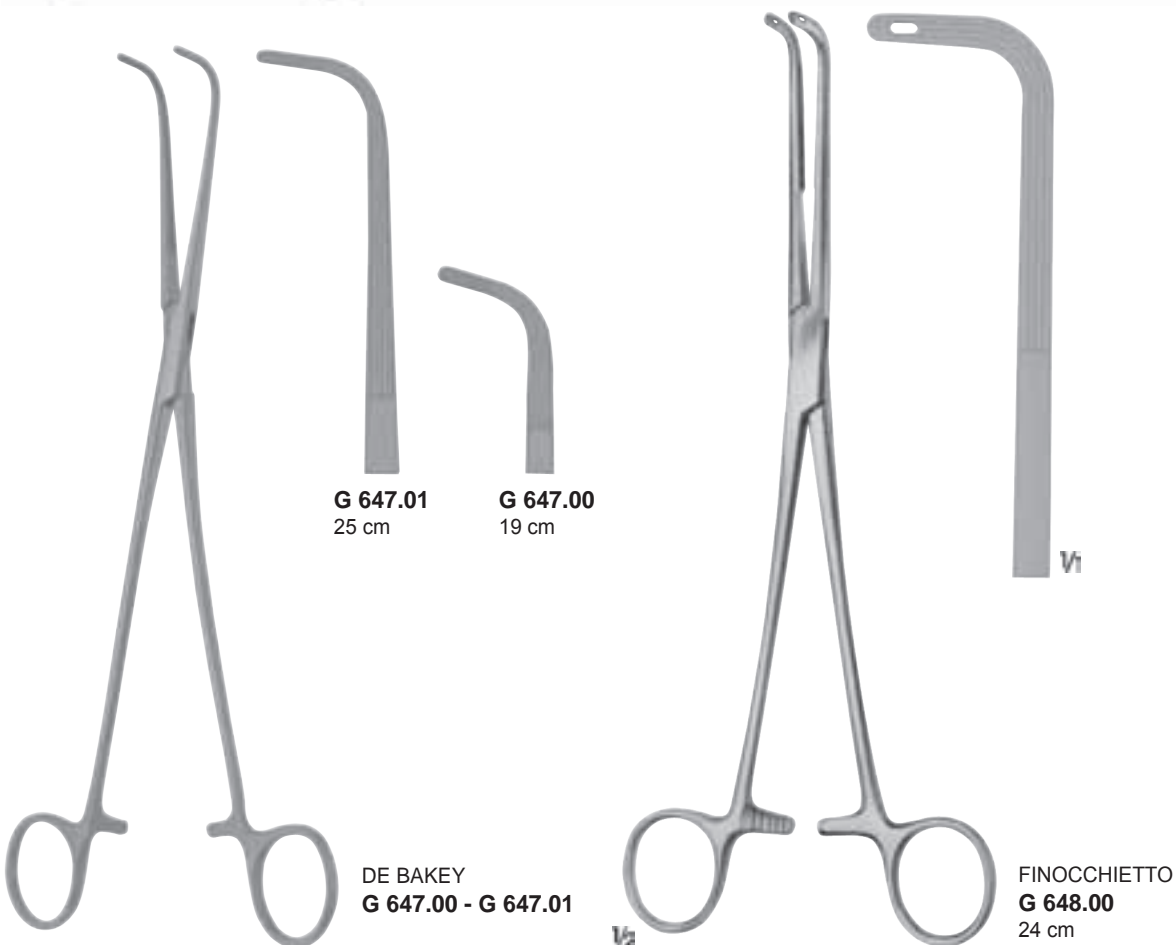
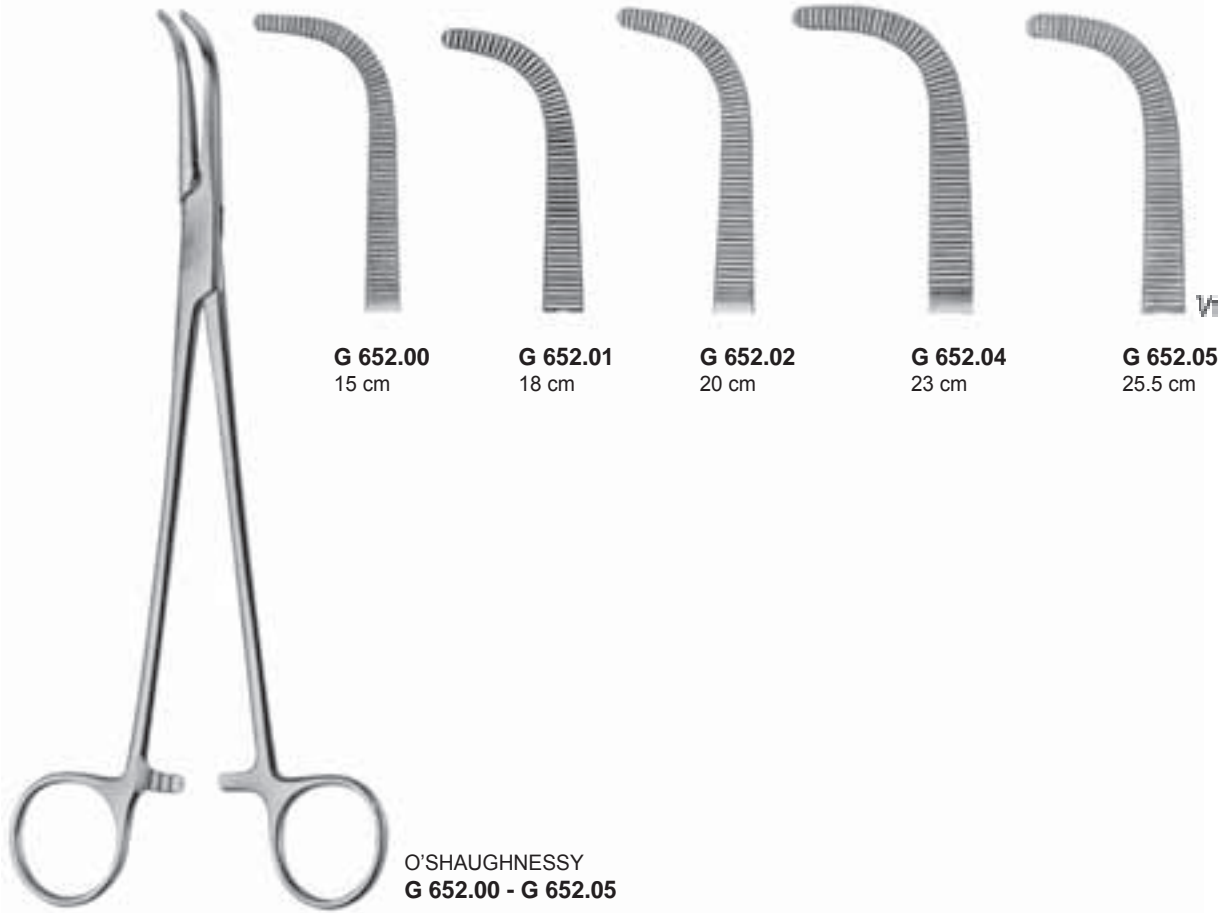



G 674.00
22 cm

G 674.01
25 cm

MIXTER
G 674.00 - G 674.01



Vt

FINOCCHIETTO
G 680.00
24.5 cm

**Atromatik
Atraumatic**



**WERTHEIM
G 770.00**
25 cm



**WERTHEIM-CULLEN
G 771.00**
21.5 cm

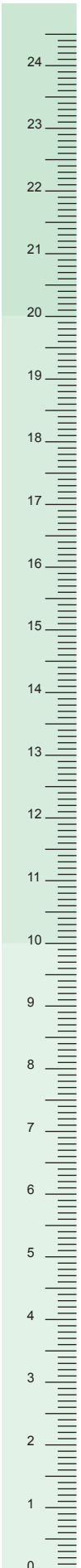

De Bakey Diş



Toothing De BAkey

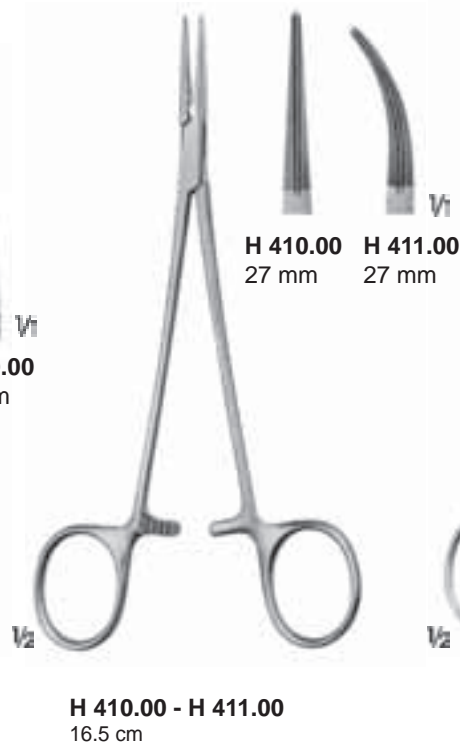
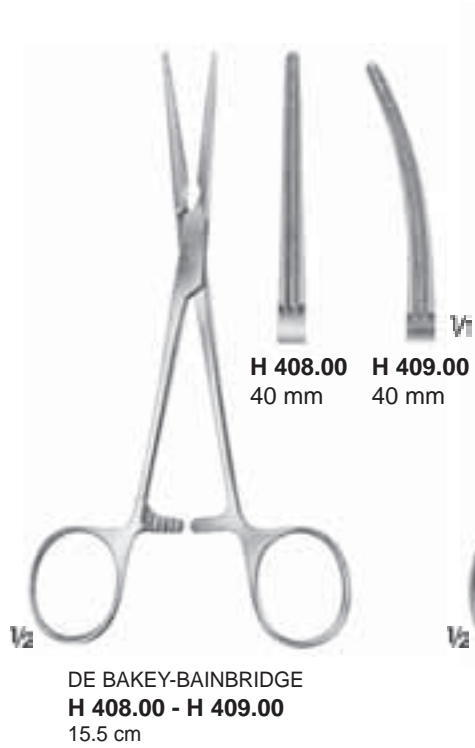
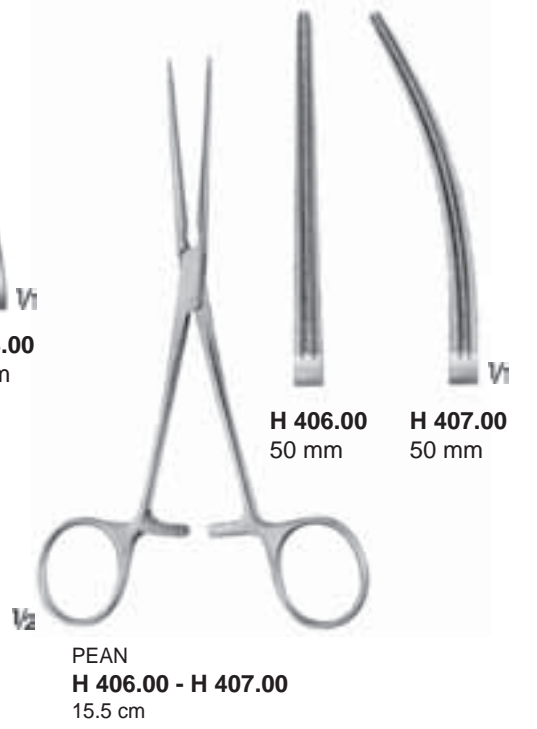
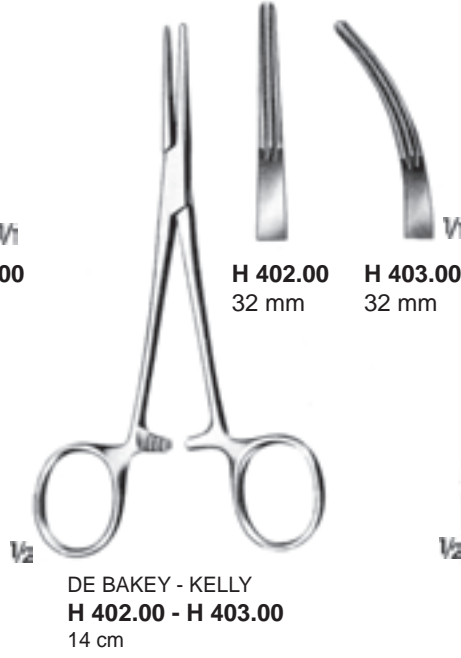
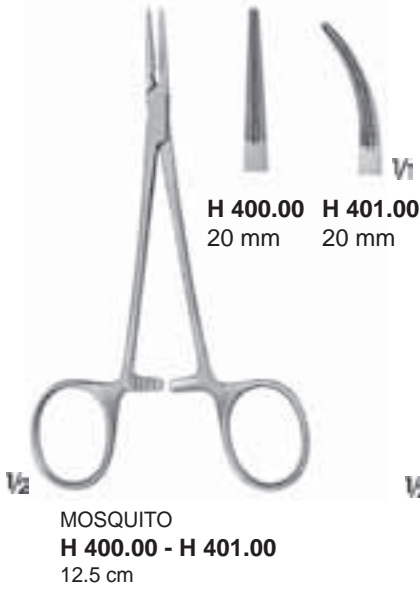

De Bakey Diş



Toothing De BAkey



H 510.00
60 mm

H 510.01
89 mm

H 510.02
99 mm

H 511.00
60 mm

H 511.01
89 mm

H 511.02
99 mm

DE BAKEY-PEAN
H 510.00 20 cm
H 510.01 26.5 cm
H 510.02 28 cm

DE BAKEY-PEAN
H 511.00 20 cm
H 511.01 26.5 cm
H 511.02 27.5 cm

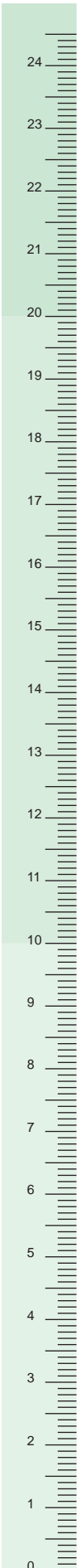

De Bakey Diş



Toothing De BAkey

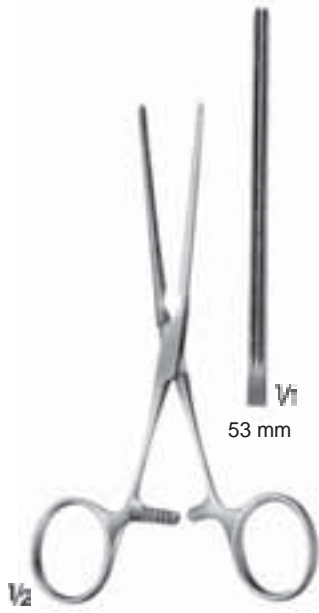

DE BAKEY
H 520.00
Düz/Straight
13 cm



DE BAKEY
H 521.00
Eğri/Curved
12.5 cm

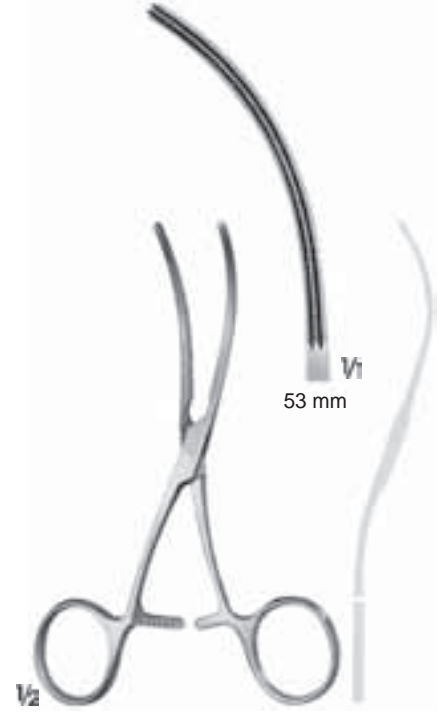

DE BAKEY
H 522.00
S-Biçimli/S-shaped
12.5 cm

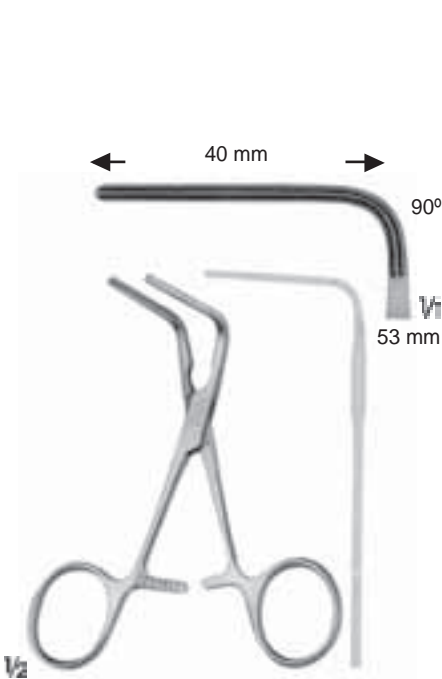

DE BAKEY
H 524.00
90° Açılı/Angled 90°
10.5 cm



NOON
H 525.00
40° Açılı/Angled 40°
11 cm

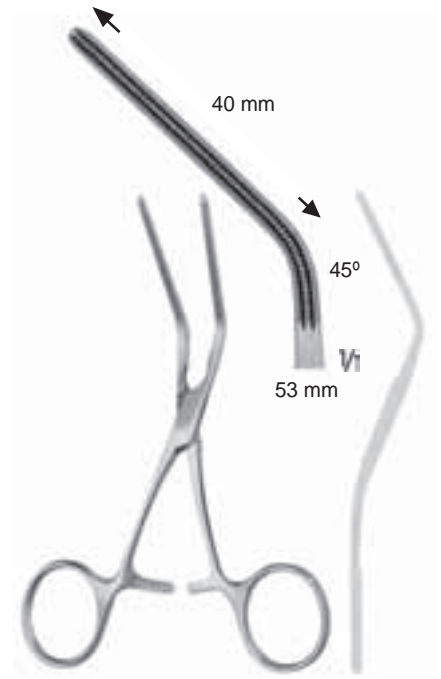

DE BAKEY
H 523.00
45° Açılı/Angled 45°
12.5 cm

De Bakey Diş



Toothing De BAkey

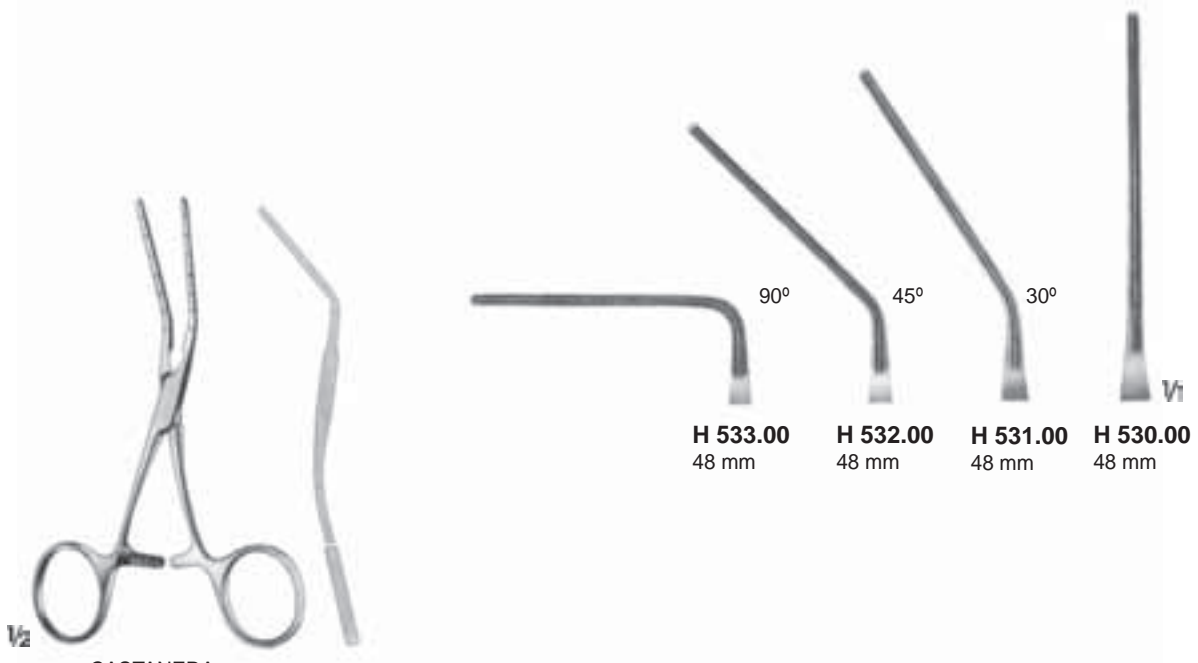

CASTANEDA
H 530.00 12.5 cm
H 531.00 12 cm
H 532.00 12 cm
H 533.00 10.5 cm

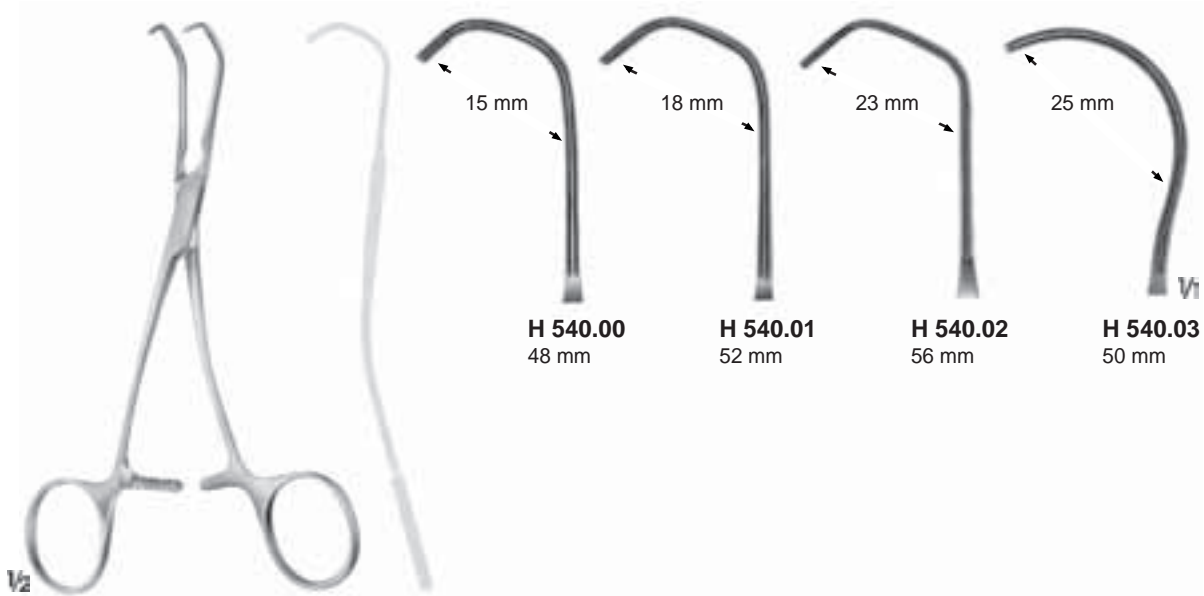

CASTANEDA
H 540.00 - H 540.03
 15.5 cm

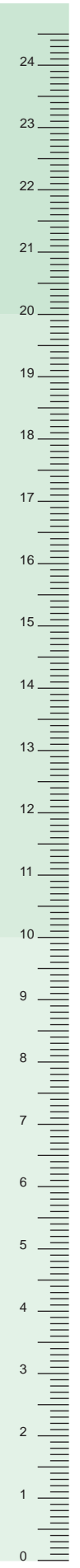

De Bakey Diş



Toothing De BAkey

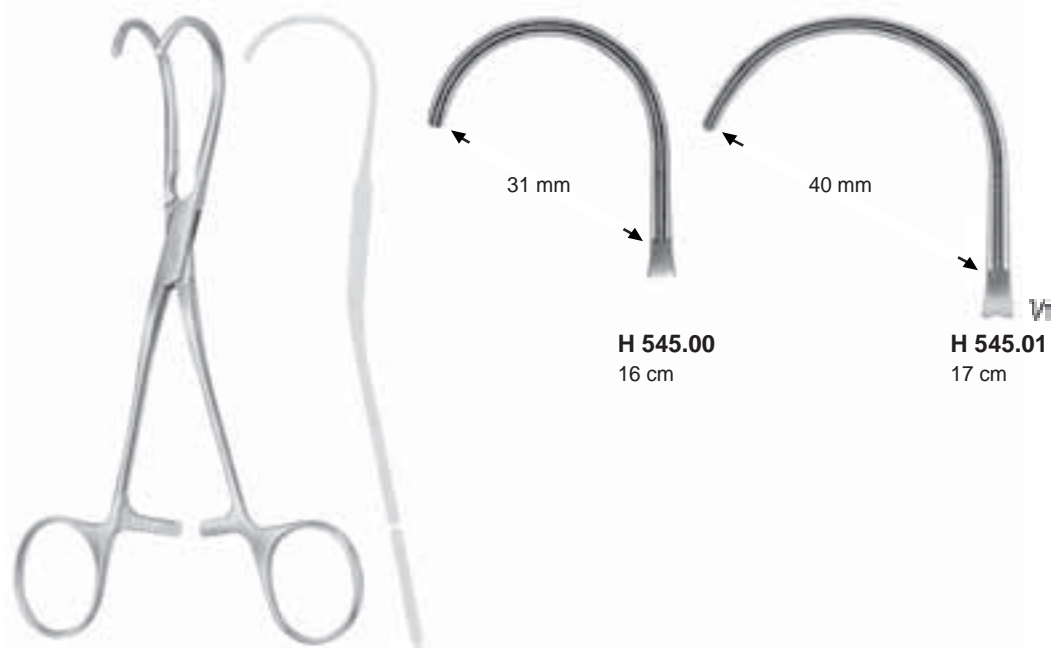

DE BAKEY
H 545.00 - H 545.01

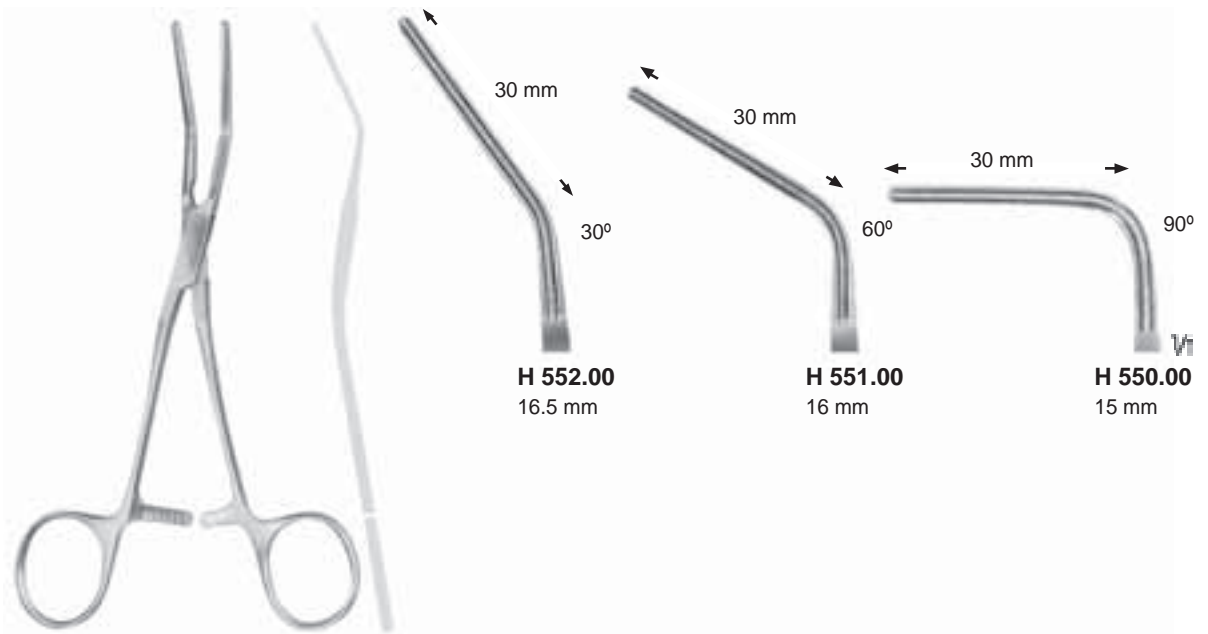

COOLEY
H 550.00 - H 552.00

De Bakey Diş



Toothing De BAkey

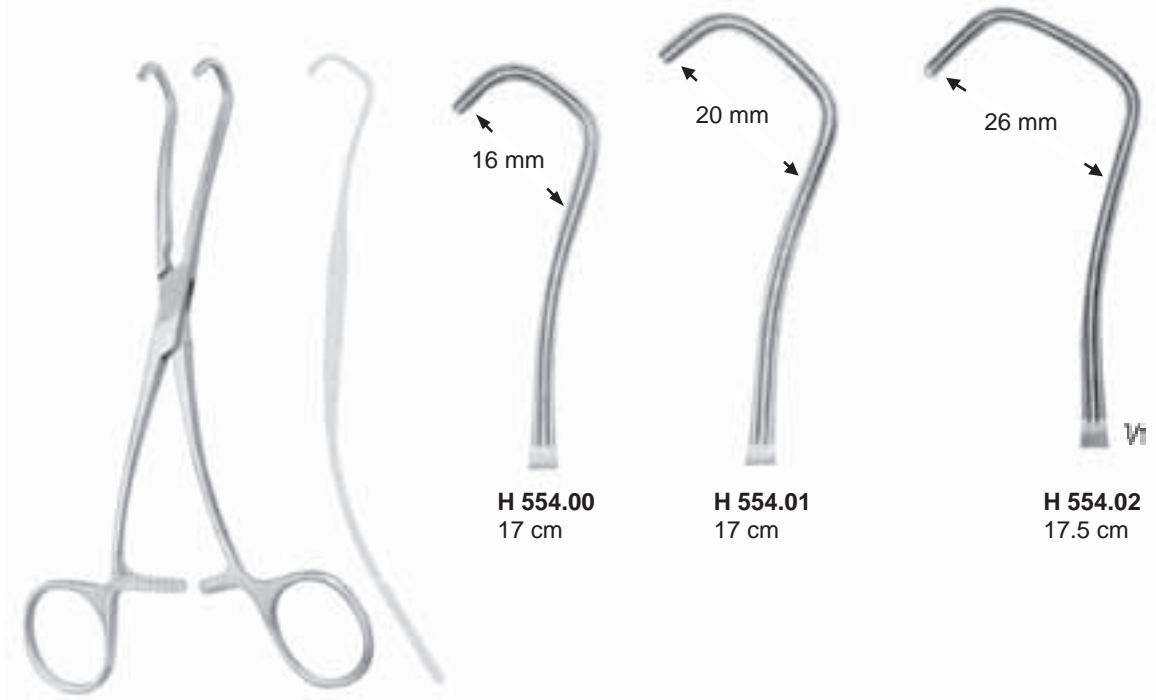

DERRA
H 554.00 - H 554.02

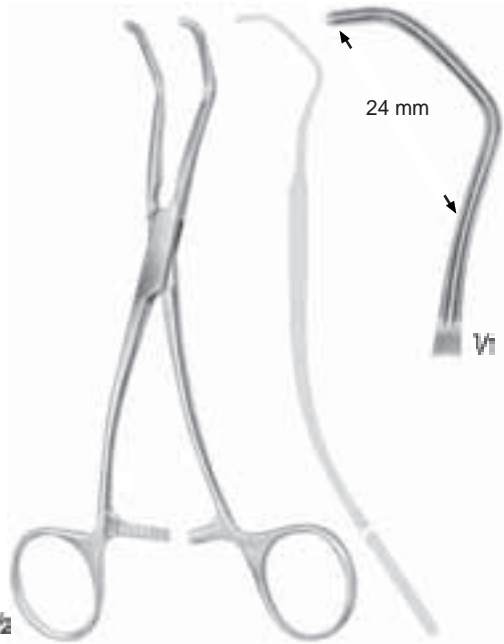

COOLEY
H 556.00
16 cm

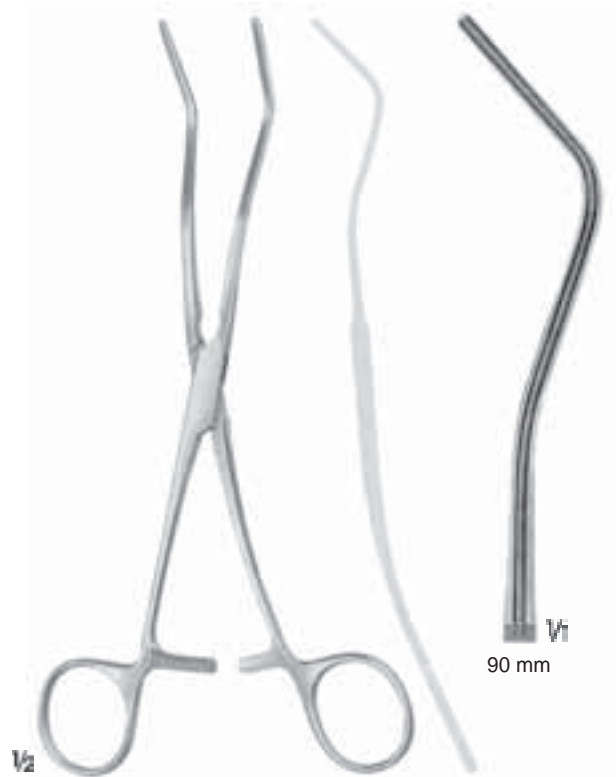

COOLEY
H 562.00
20 cm

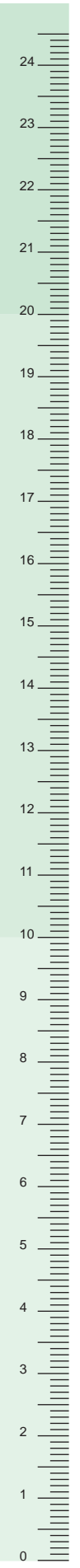

De Bakey Diş



Toothing De BAkey



GLOVER
H 546.00
17 cm

H 547.00
17.5 cm

DE BAKEY-BECK
H 548.00
17 cm



H 549.00
15.5 cm

H 549.01
17 cm

H 549.02
16.5 cm

H 549.03
15.5 cm

H 534.00
15.5 cm

H 534.01
17 cm

DE BAKEY
H 549.00 - H 549.03

DE BAKEY
H 534.00 - H 534.01

De Bakey Diş



Toothing De BAkey

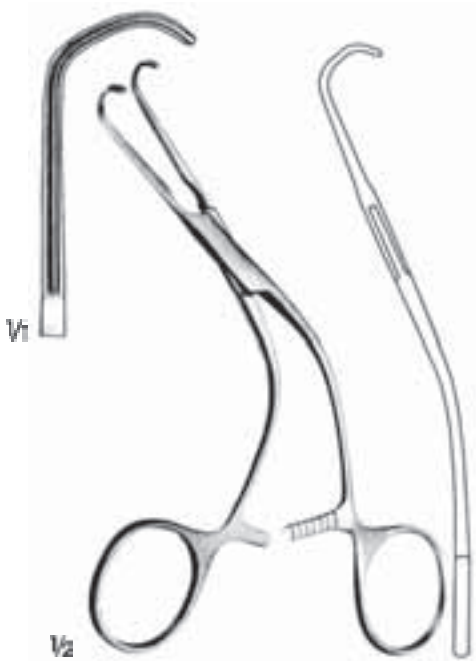

REIN
H 560.00
Sol/Left
15.5 cm

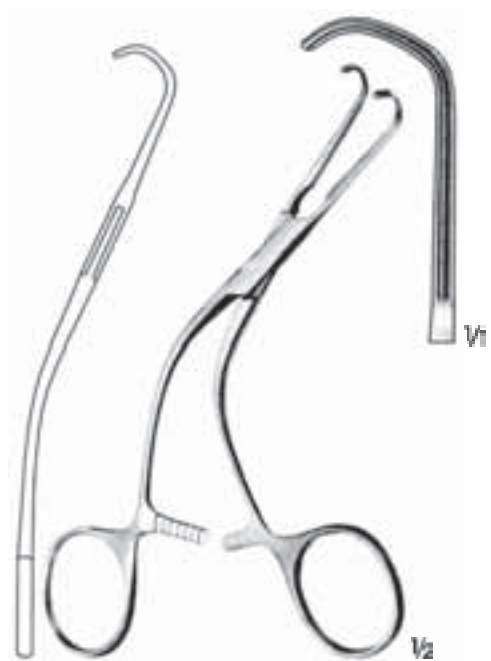

REIN
H 561.00
Sağ/Right
15.5 cm

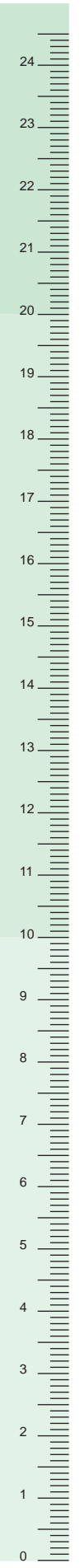

De Bakey Diş



Toothing De BAkey

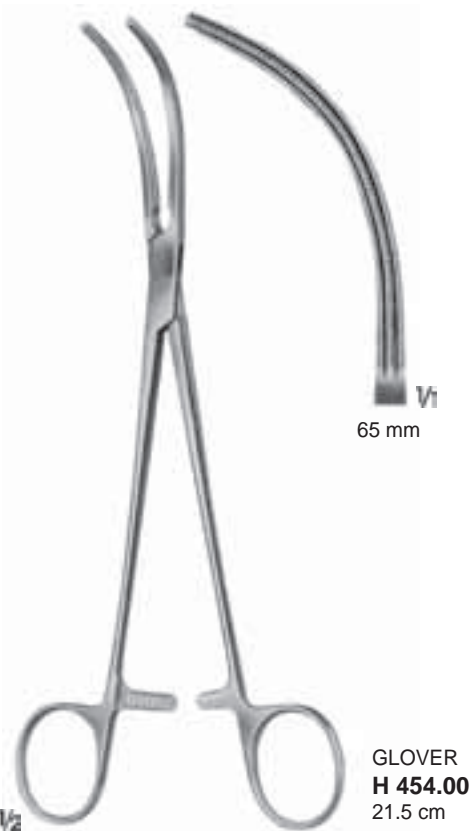
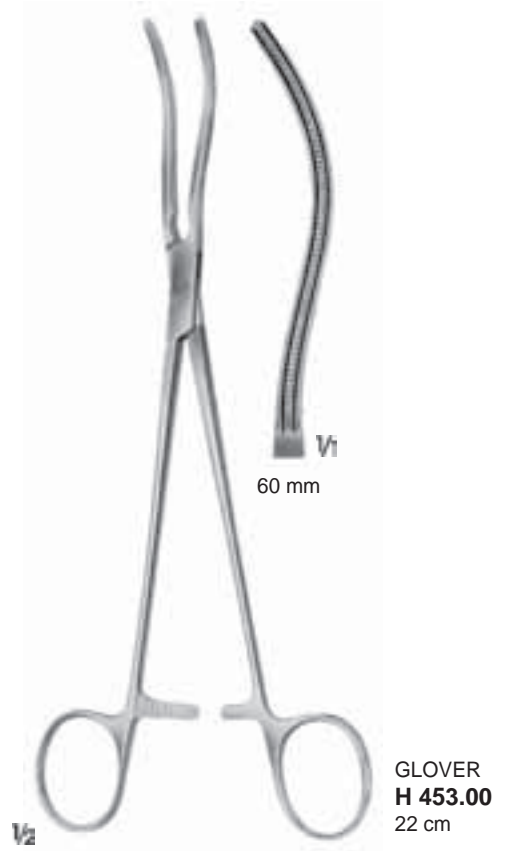

De Bakey Diş



Toothing De BAkey



DE BAKEY-REYNOLDS
H 535.00 - H 535.04

H 535.00
16.5 cm

H 535.01
16.5 cm

H 535.03
18 cm

H 535.04
18 cm



POTTS
H 456.00
22 cm



POTTS
H 457.00
22 cm



GLOVER
H 458.00
26 cm

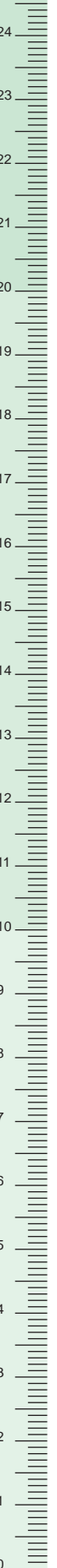

De Bakey Diş



Toothing De BAkey

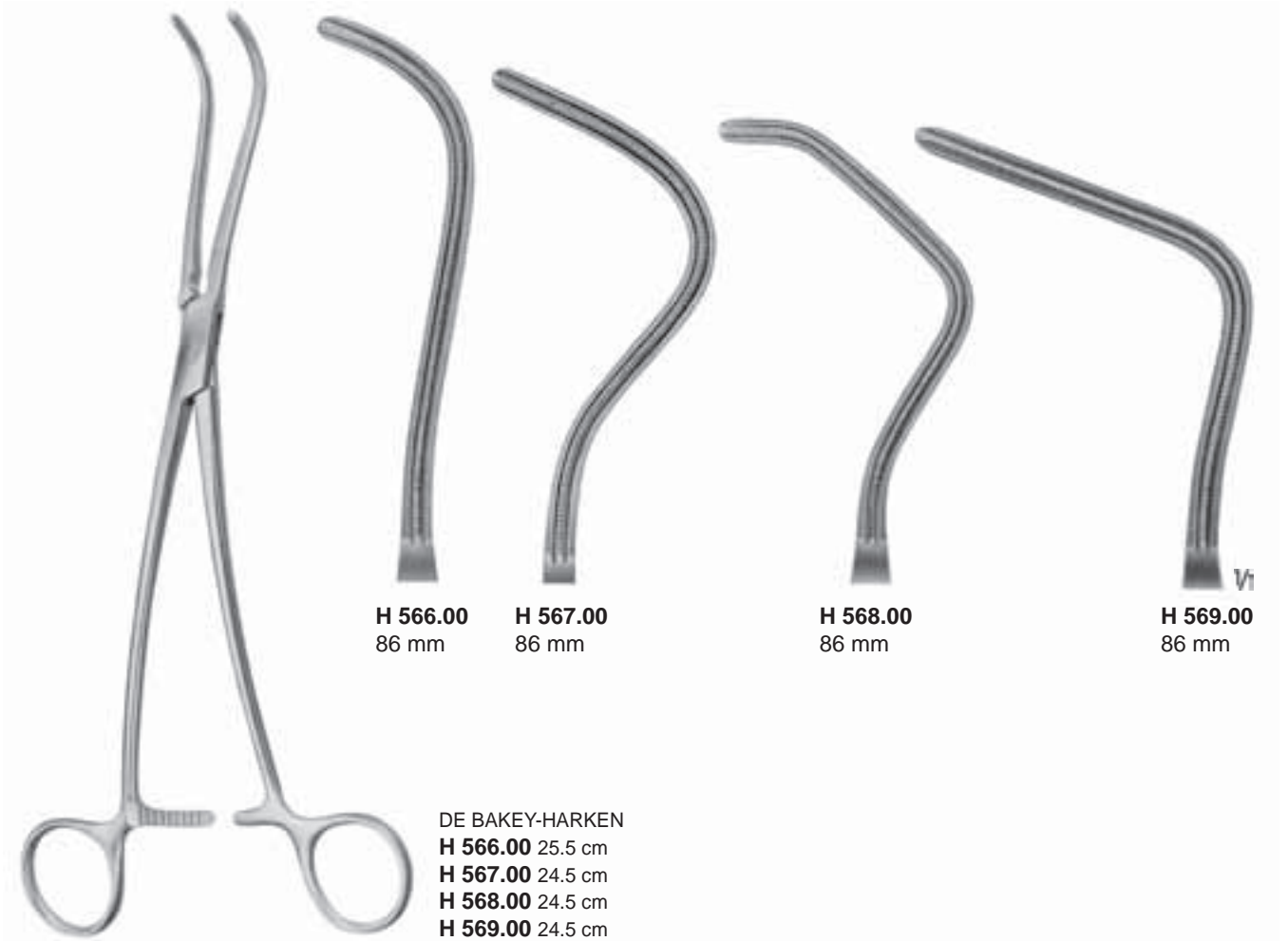
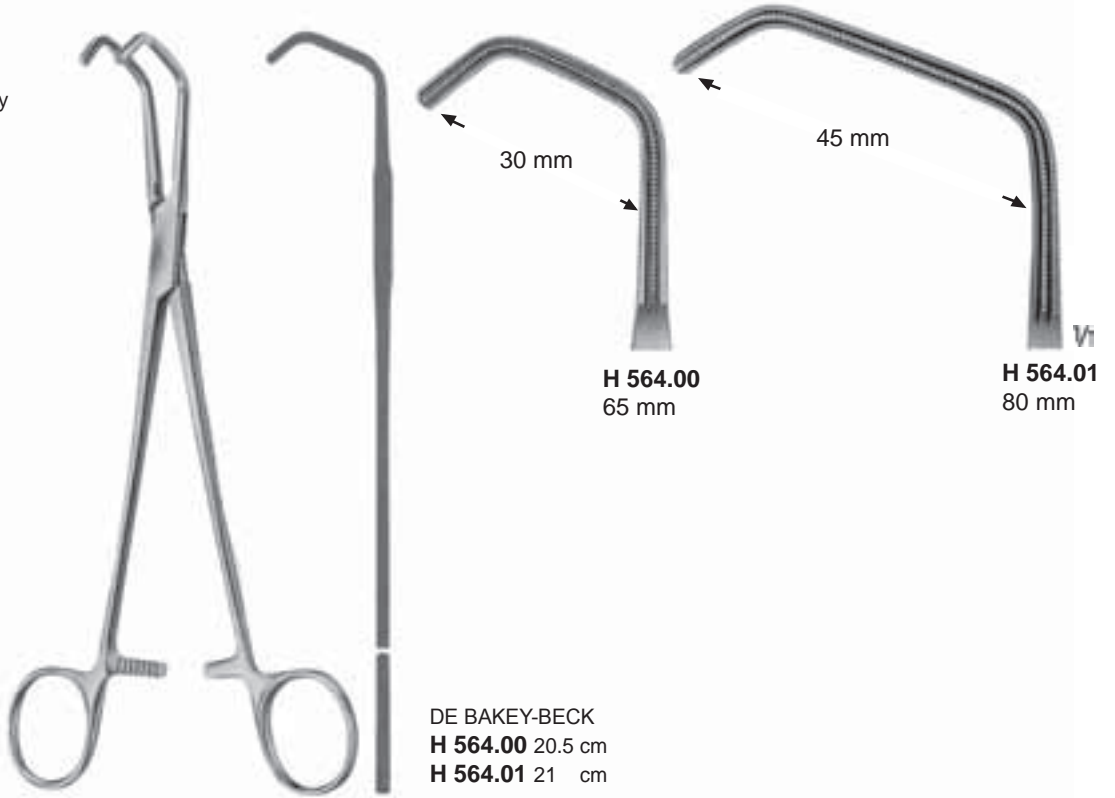

De Bakey Diş



Toothing De BAkey

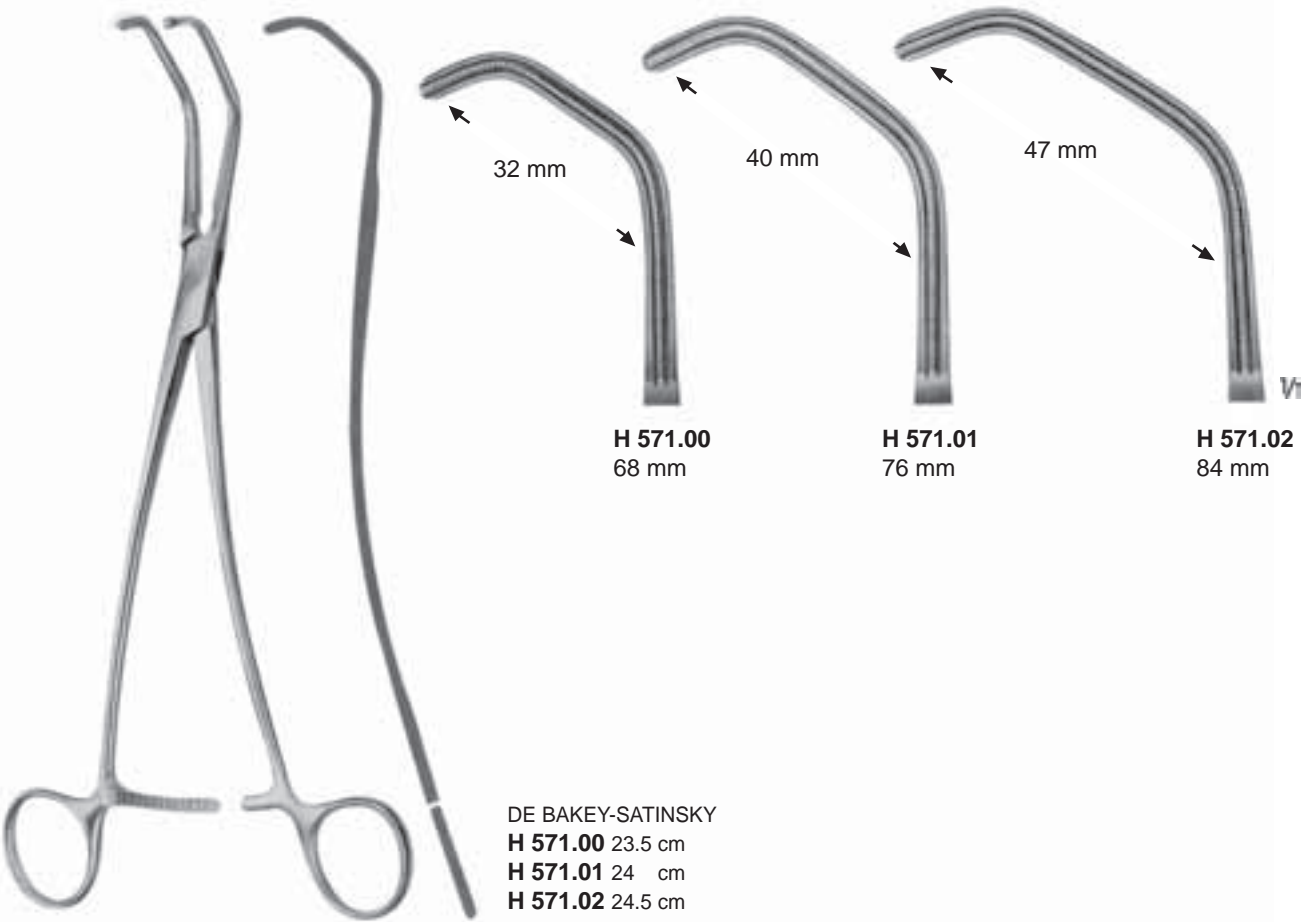
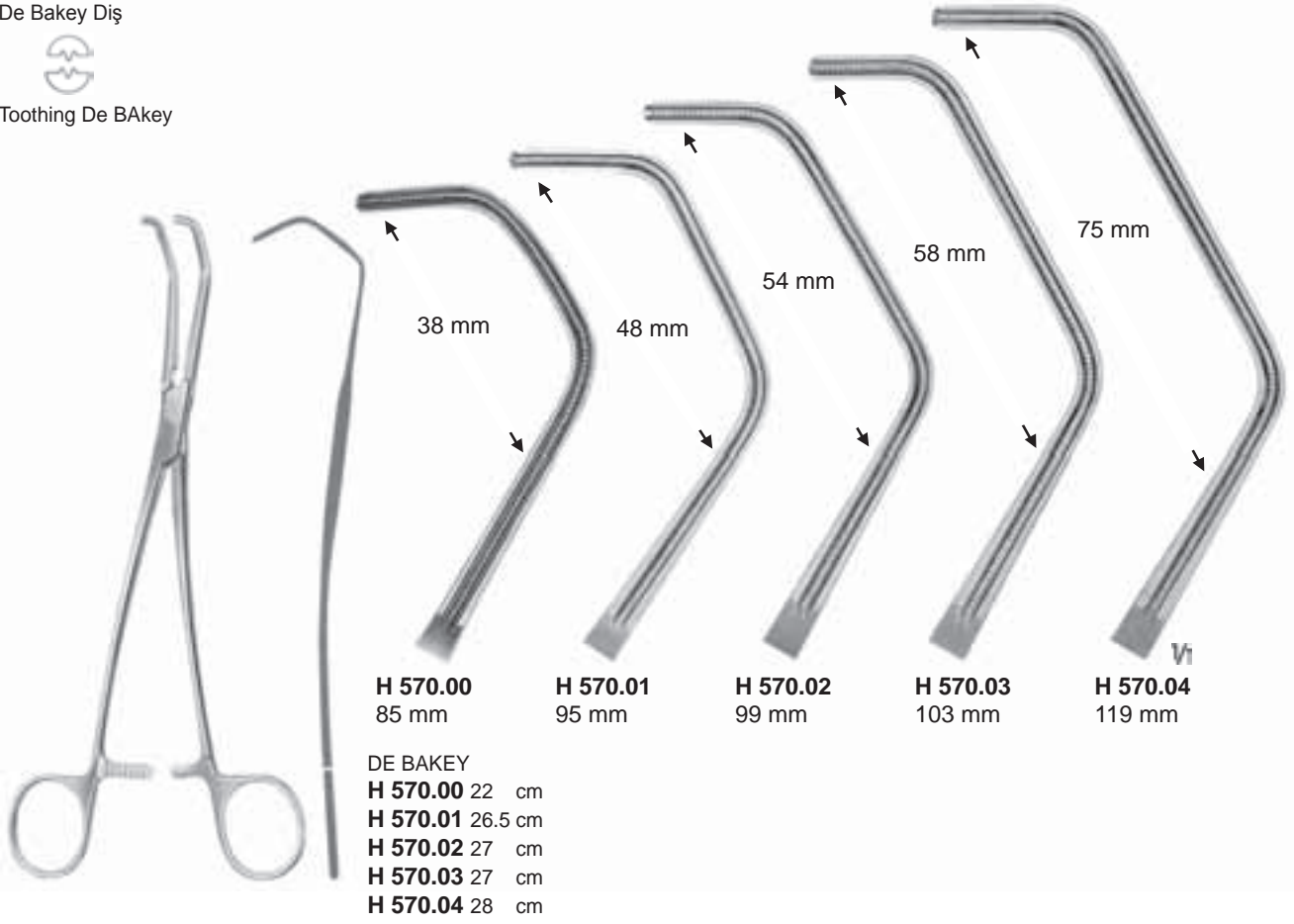

De Bakey Diş



Toothing De BAkey

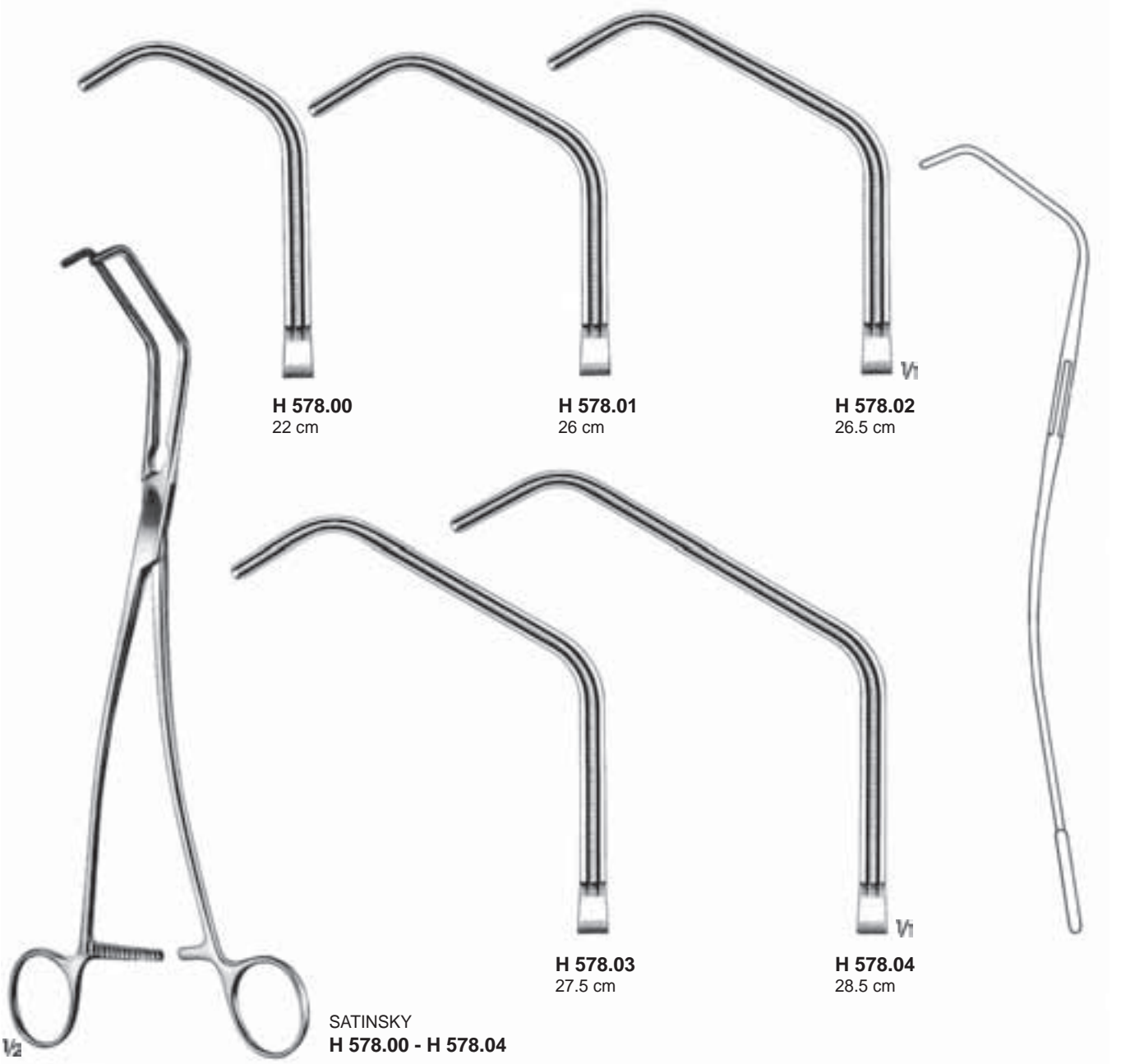

De Bakey Diş



Toothing De BAkey

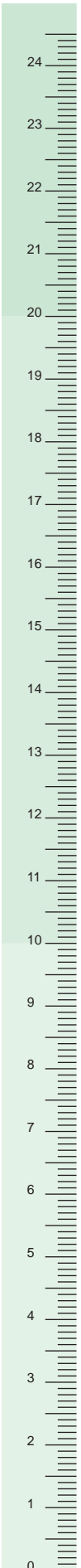
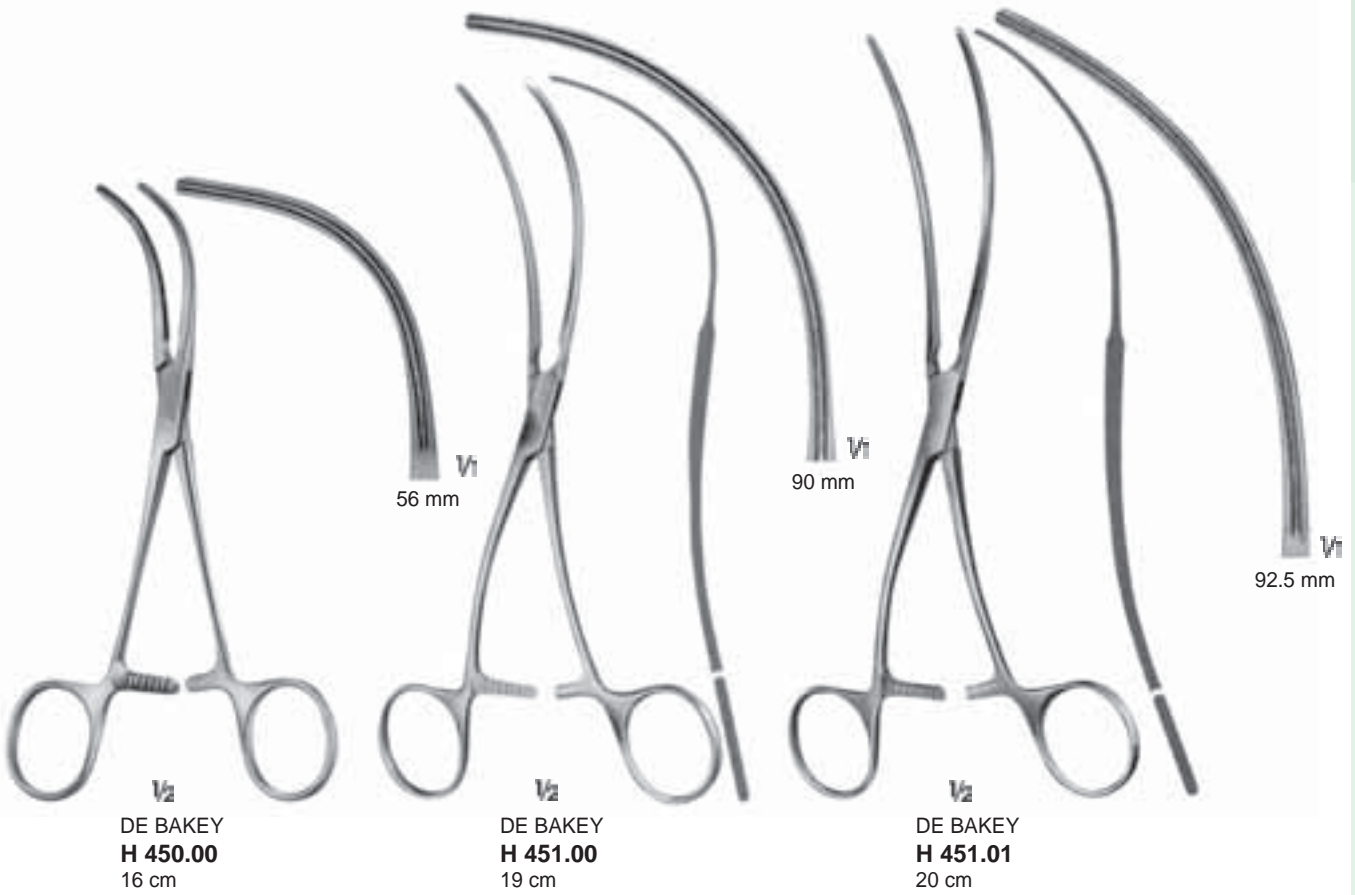
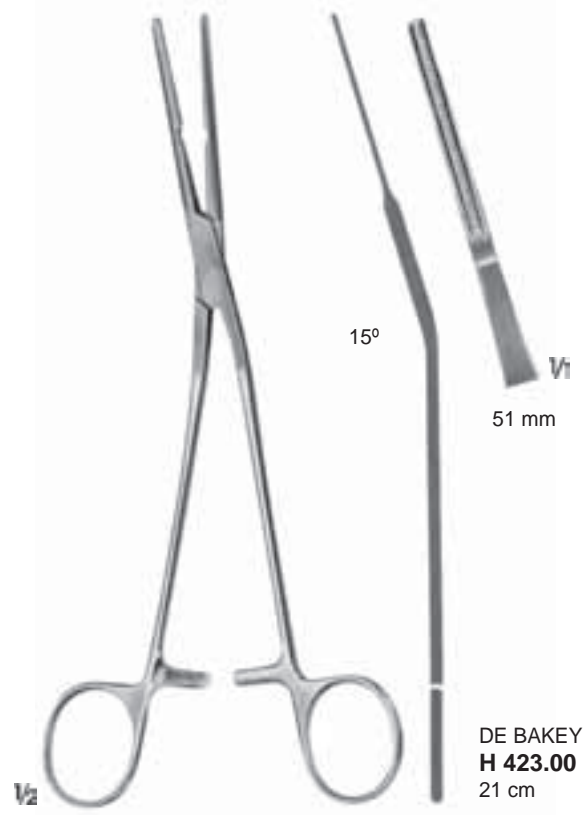

De Bakey Diş



Toothing De BAkey

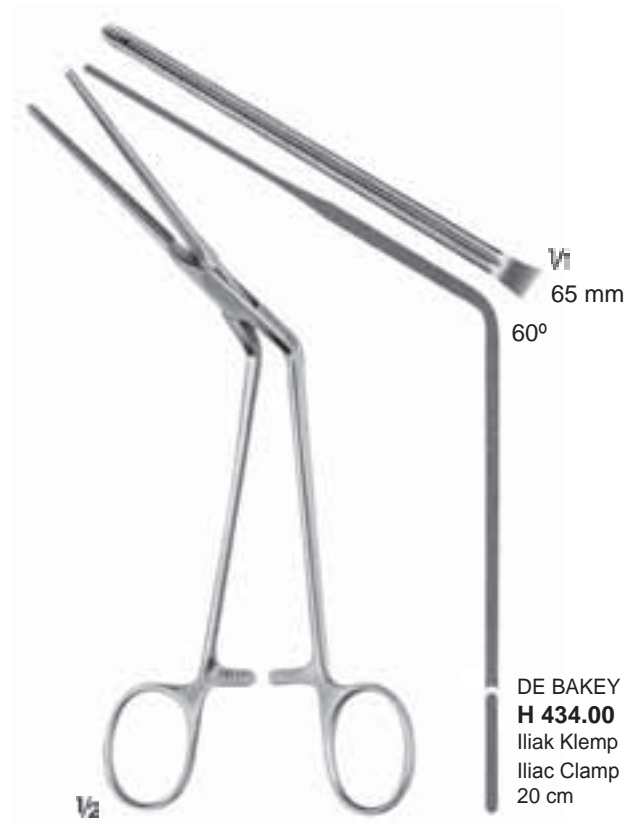
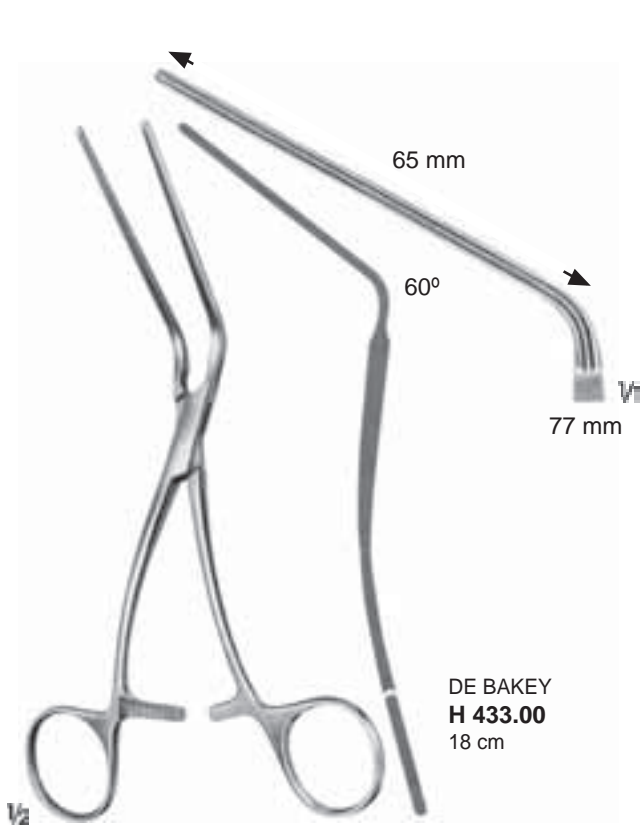
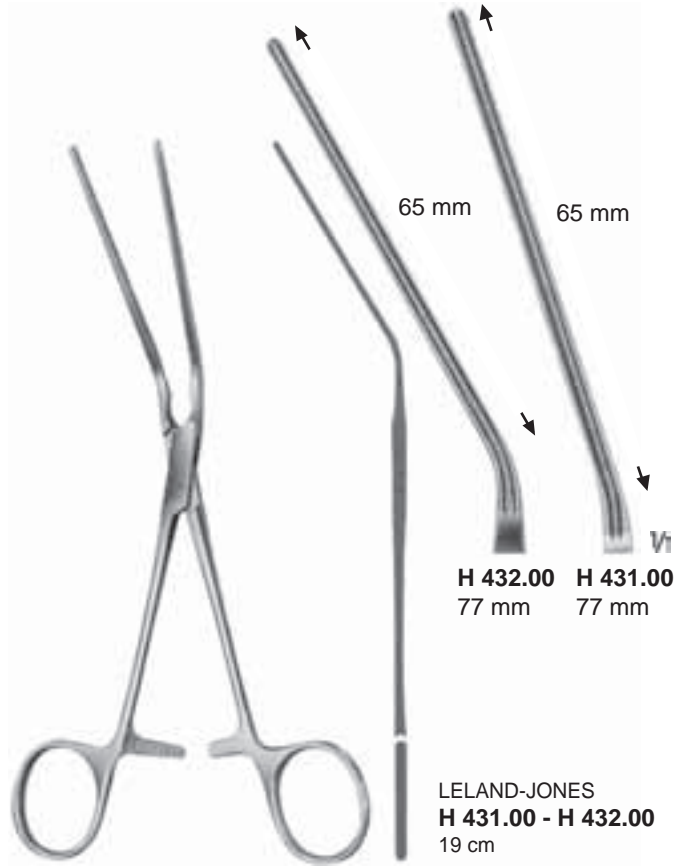

De Bakey Diş



Toothing De BAkey

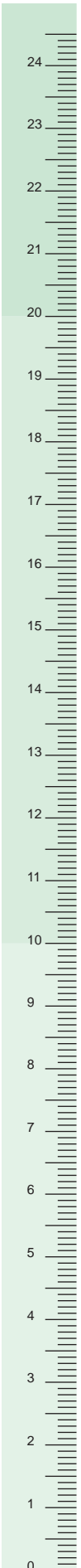

De Bakey Diş



Toothing De BAkey

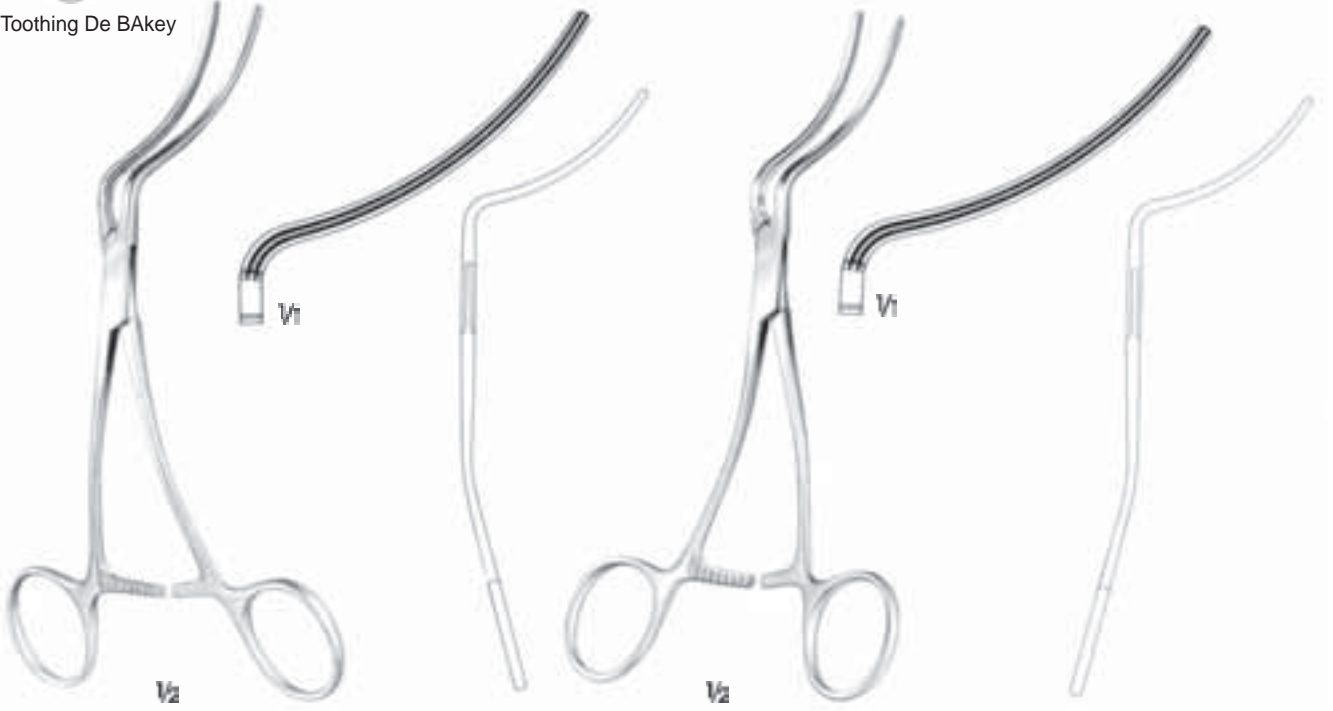

H 426.00
16 cm

H 427.00
17 cm

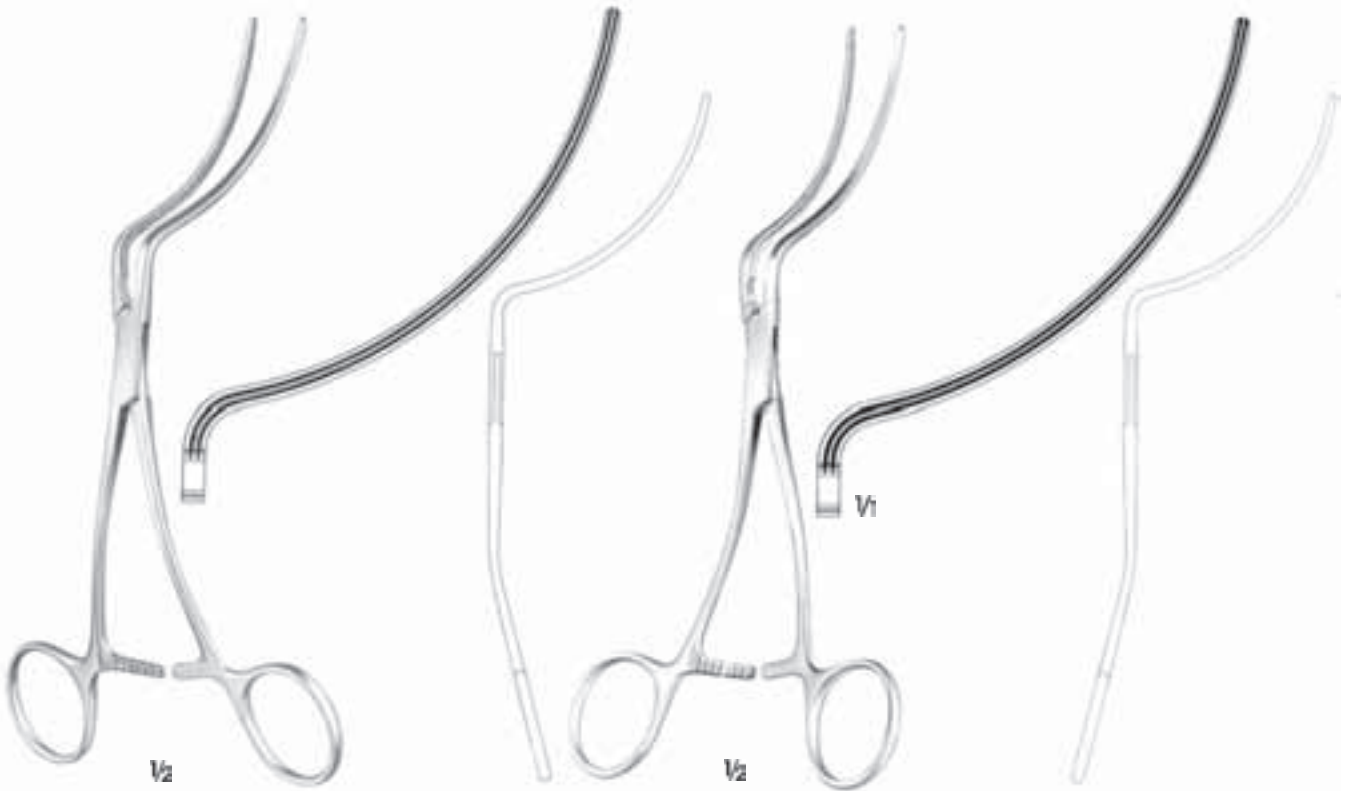

H 428.00
18 cm

H 429.00
20 cm

De Bakey Diş



Toothing De BAkey

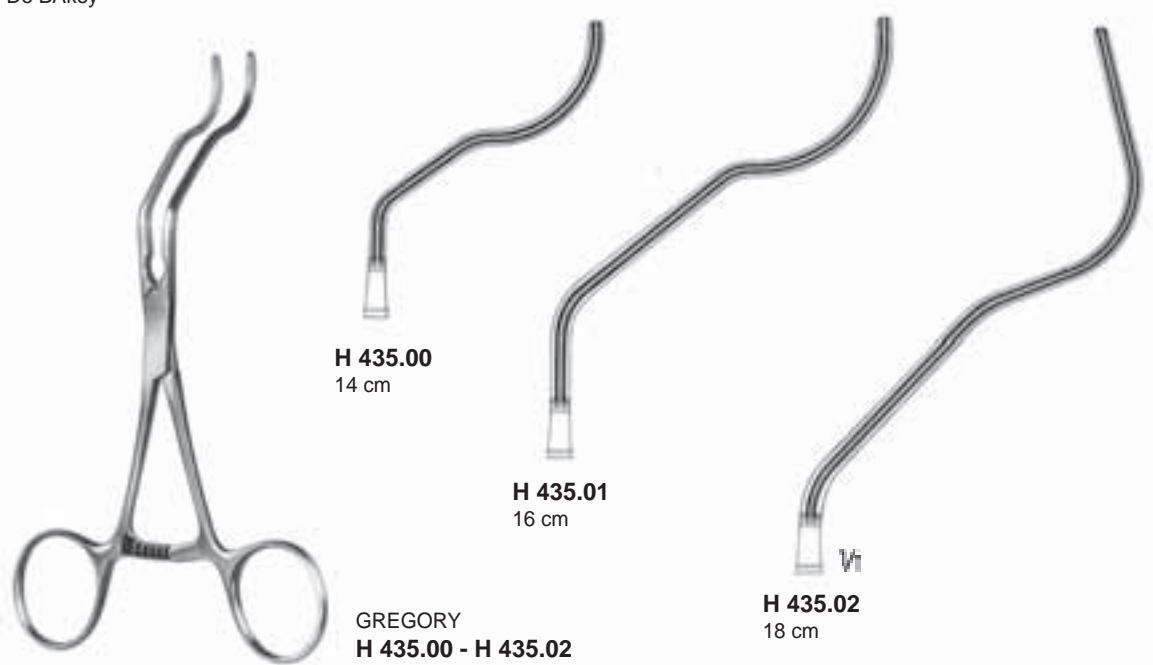

H 435.00
14 cm

H 435.01
16 cm

H 435.02
18 cm

GREGORY
H 435.00 - H 435.02



DEMOS
H 583.00
21 cm

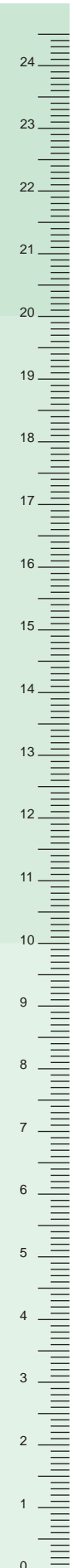

De Bakey Diş



Toothing De BAkey

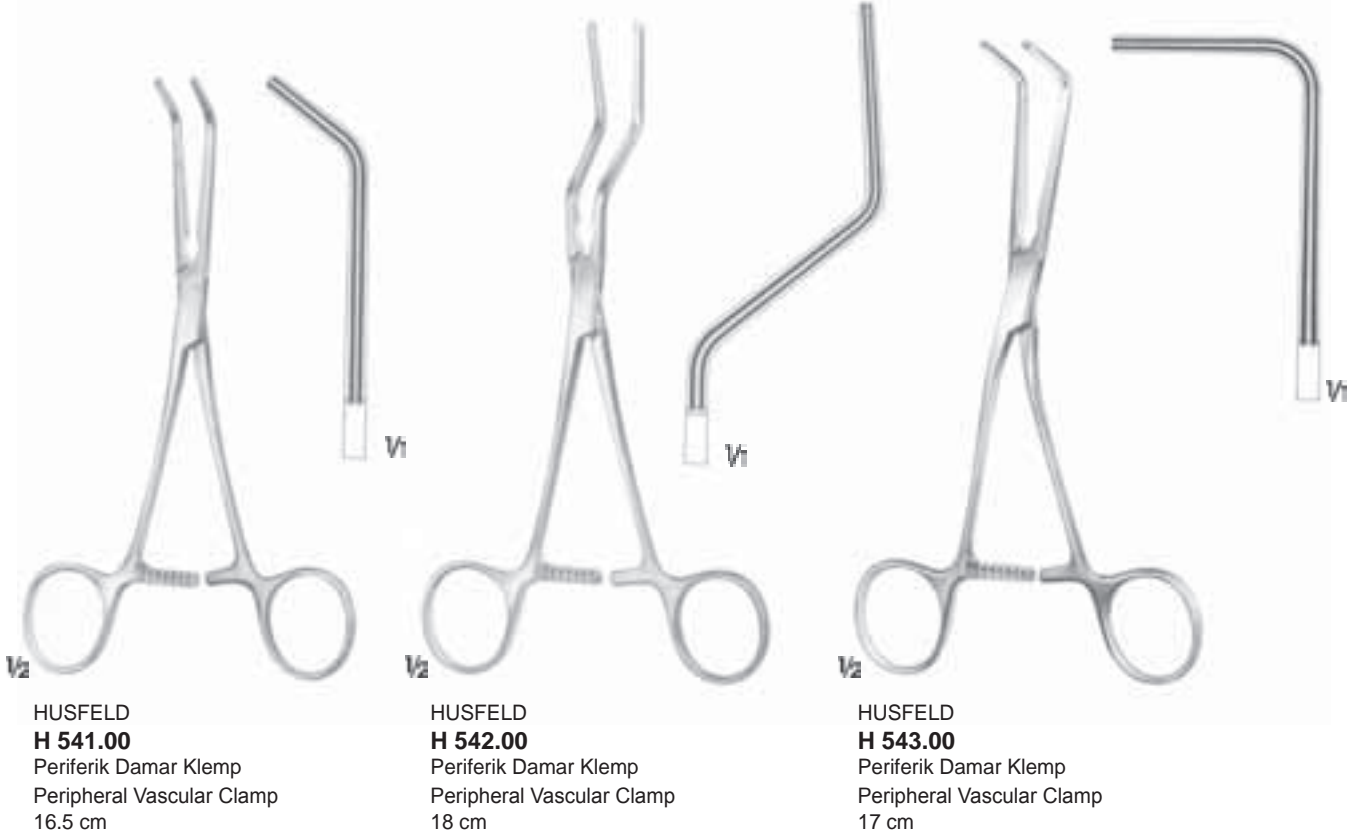

De Bakey Diş



Toothing De BAkey

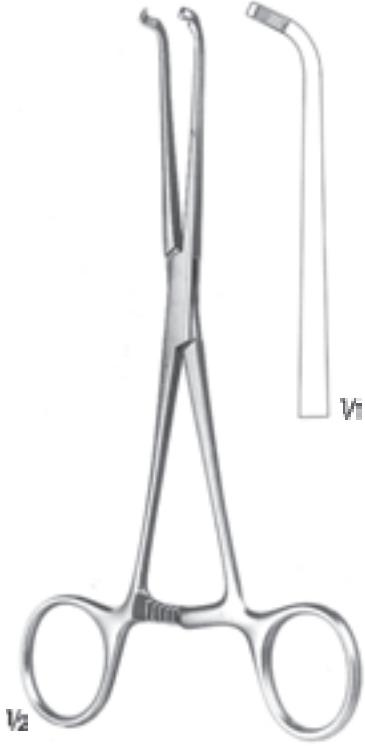

JAVID
H 537.00
Karotis Şant Klempi
Carotid Shunt Clamp
17.5 cm

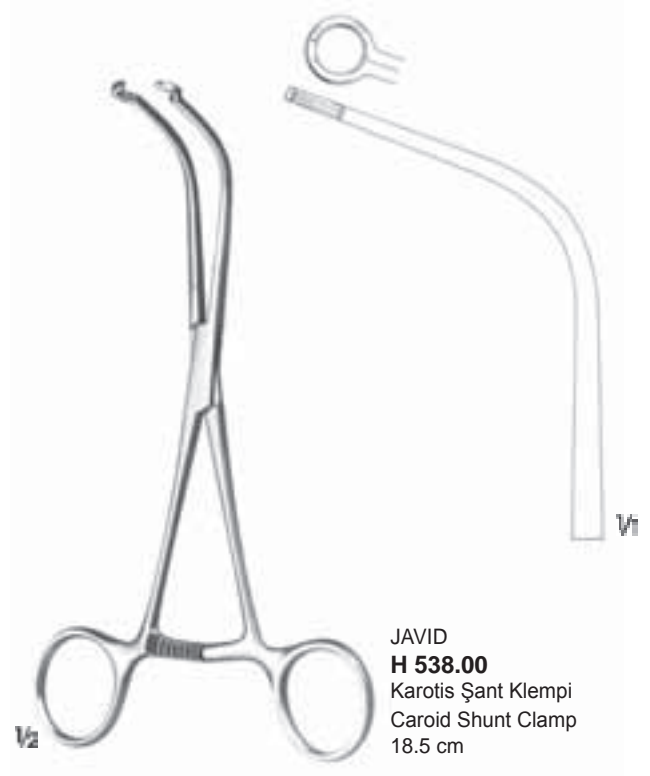

JAVID
H 538.00
Karotis Şant Klempi
Carotid Shunt Clamp
18.5 cm

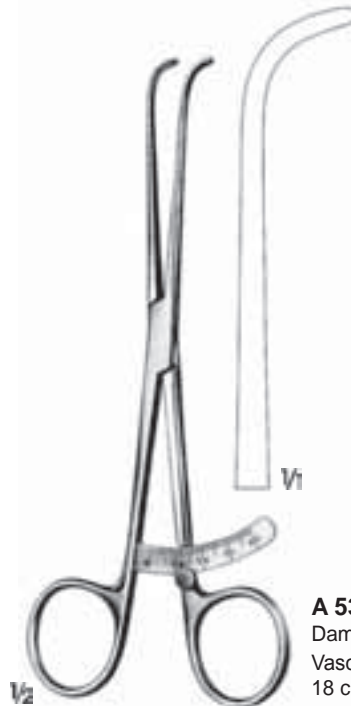

A 531.00
Damar Ölçme Aleti
Vascular Measuring Tools
18 cm

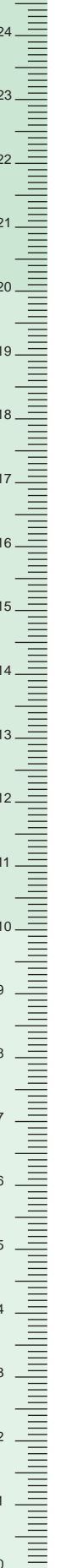

De Bakey Diş



Toothing De BAkey

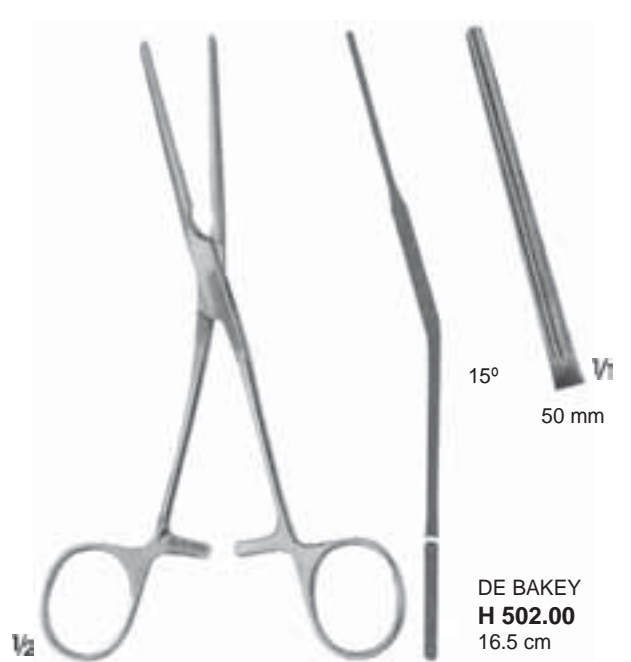

De Bakey Diş



Toothing De BAkey

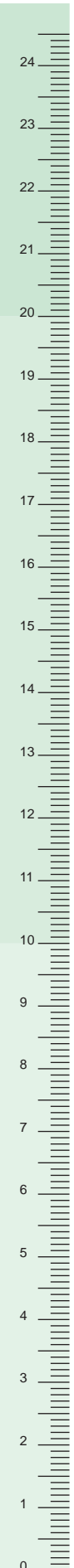
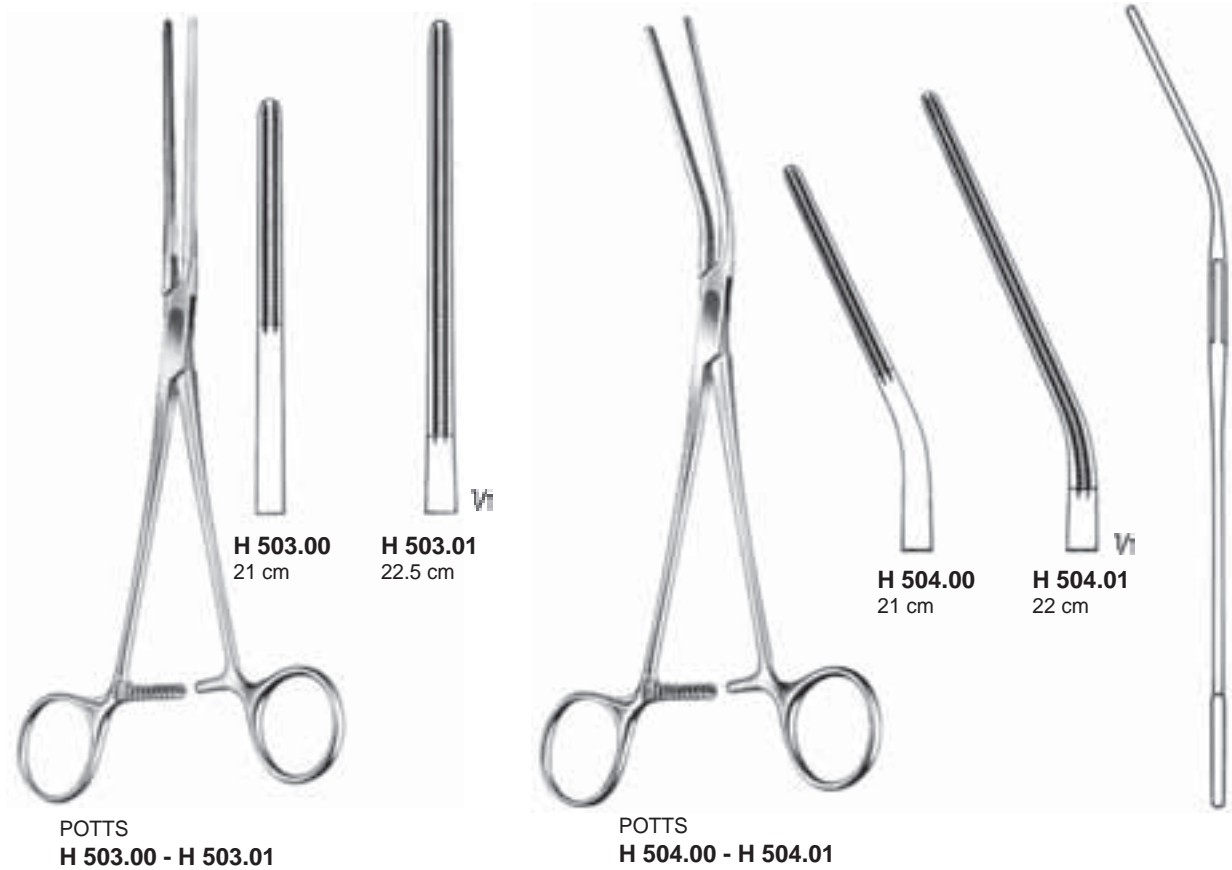

De Bakey Diş



Toothing De BAkey



POTTS
H 506.00 - H 506.03

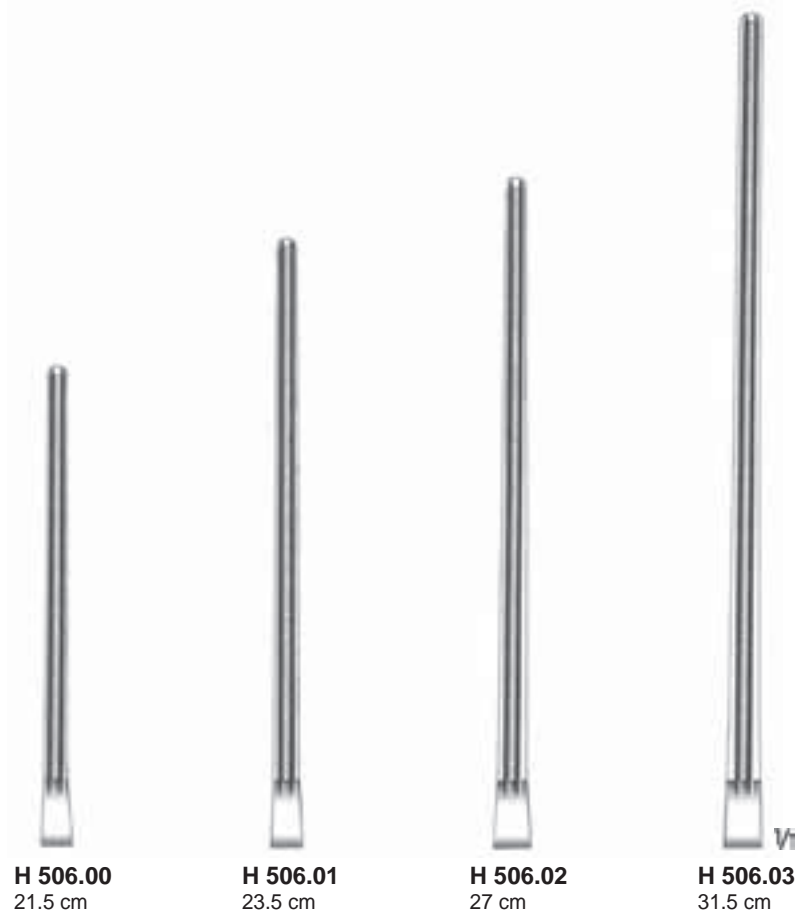

H 507.00 - H 507.03

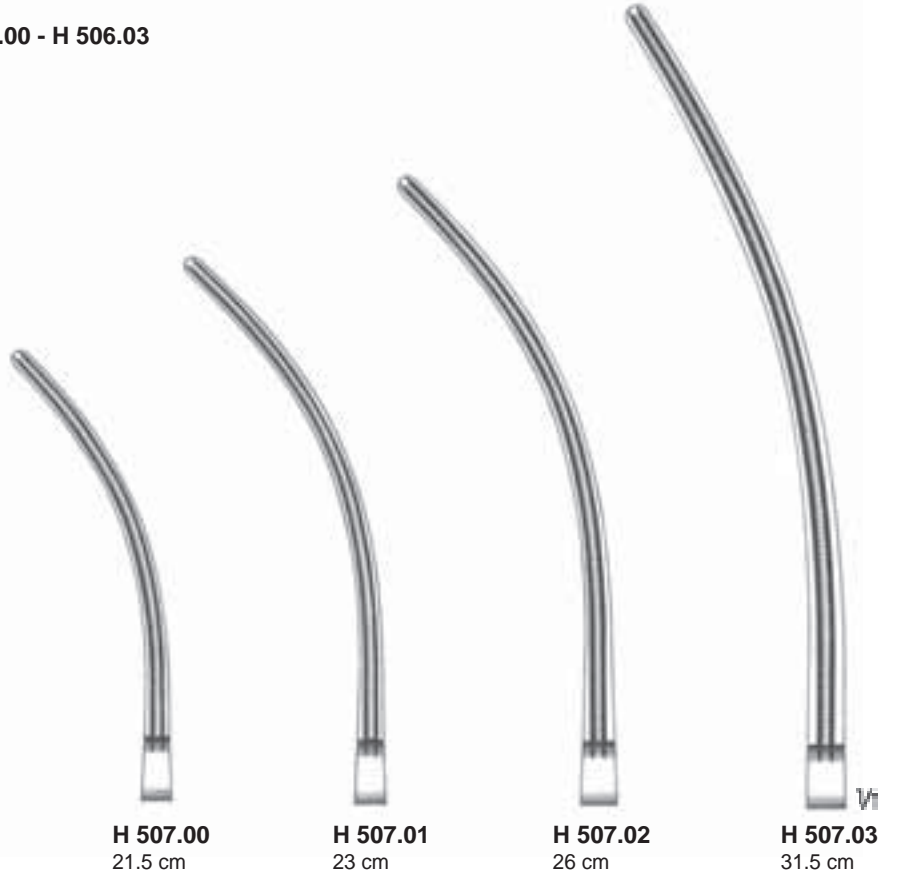

De Bakey Diş



Toothing De BAkey

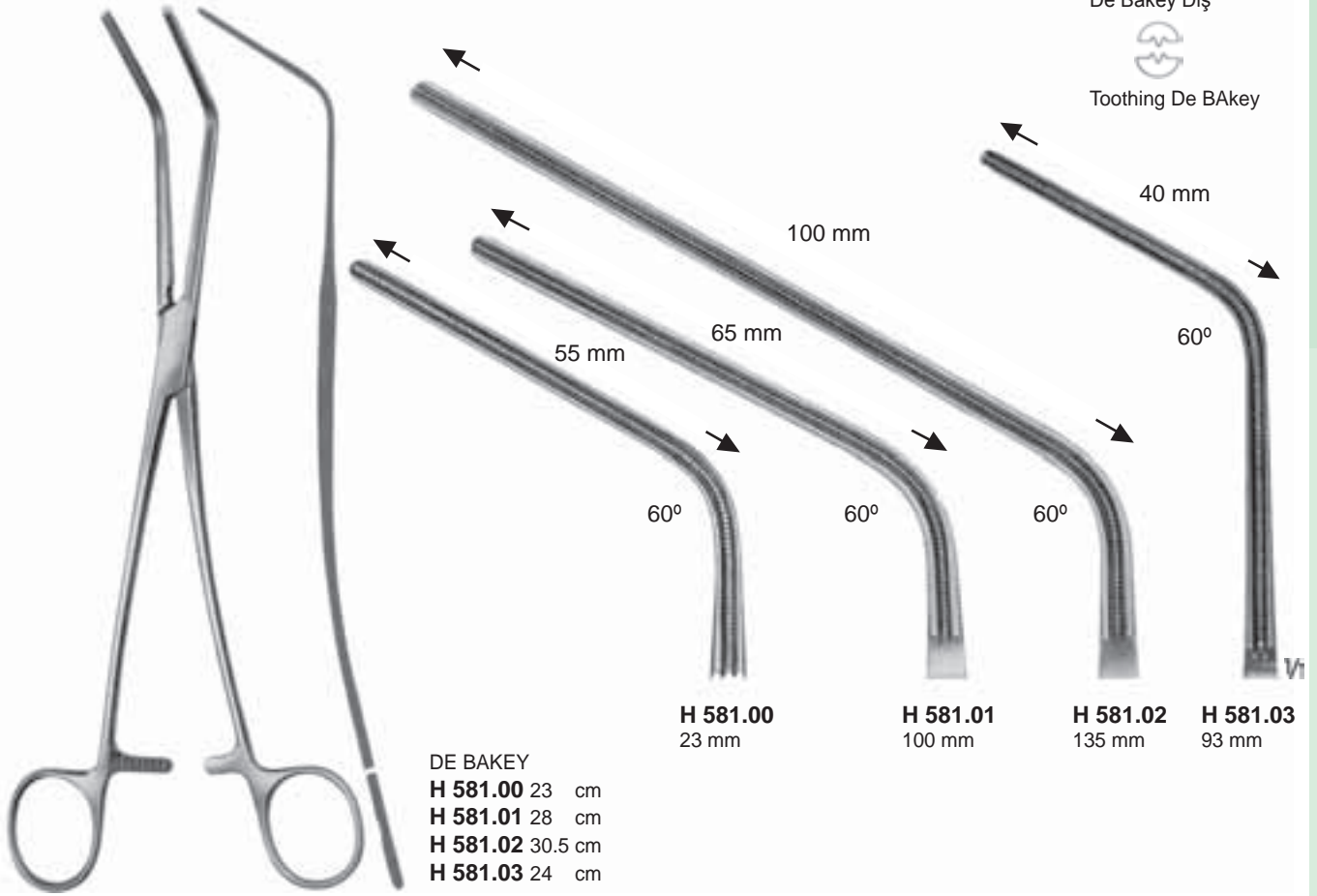

DE BAKEY
H 581.00 23 cm
H 581.01 28 cm
H 581.02 30.5 cm
H 581.03 24 cm

H 581.00
23 mm

H 581.01
100 mm

H 581.02
135 mm

H 581.03
93 mm

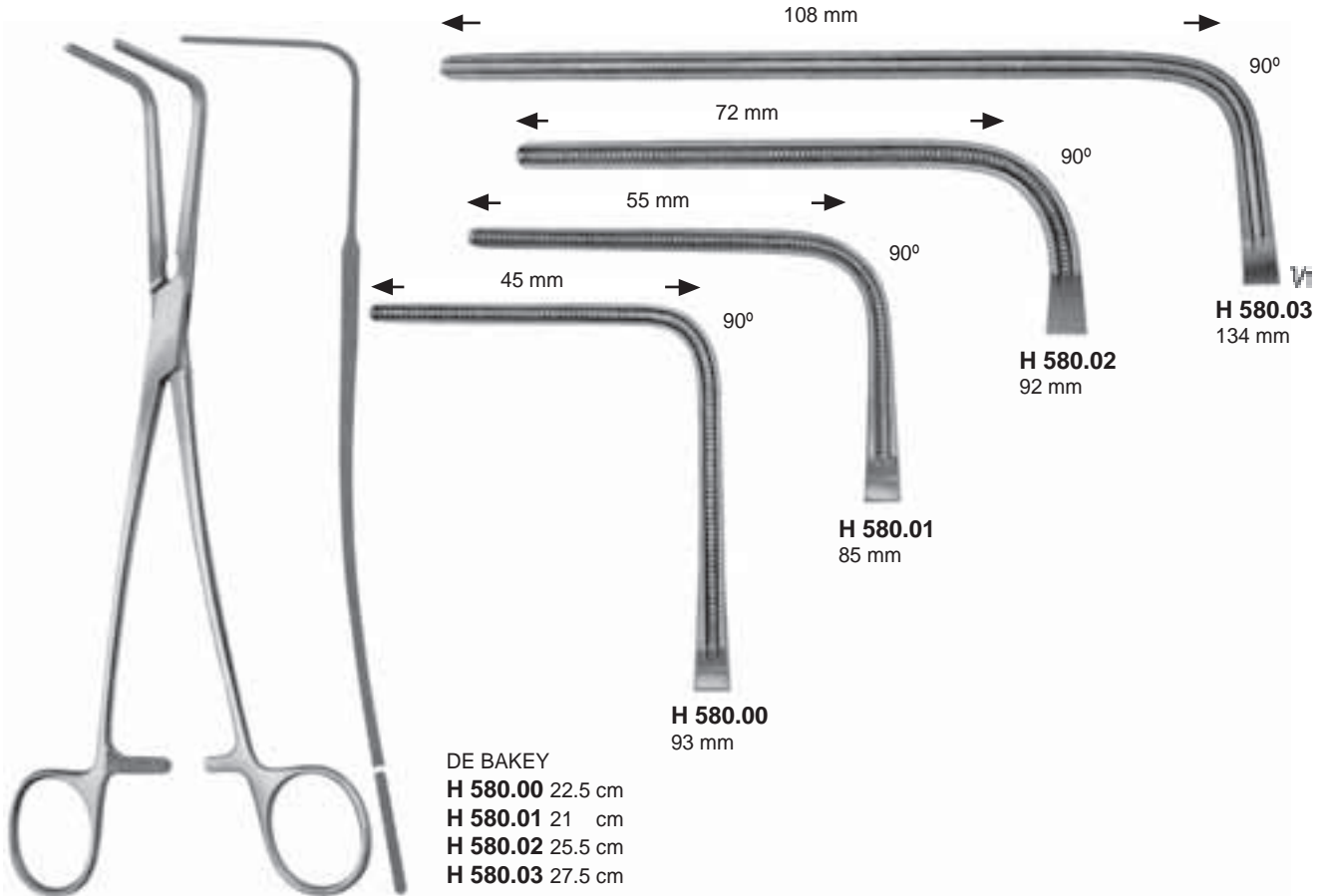

DE BAKEY
H 580.00 22.5 cm
H 580.01 21 cm
H 580.02 25.5 cm
H 580.03 27.5 cm

H 580.00
93 mm

H 580.01
85 mm

H 580.02
92 mm

H 580.03
134 mm

De Bakey Diş



Toothing De BAkey



DE BAKEY (MORRIS modif.)
H 460.01
18 cm



DE BAKEY (MORRIS modif.)
H 461.01
23 cm

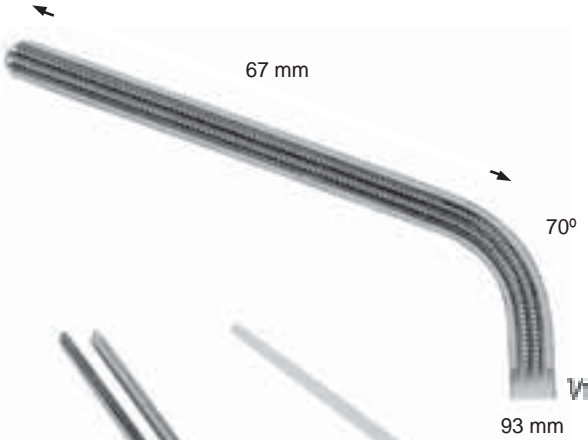

67 mm

70°

93 mm

V₂

MORRIS
H 460.00
17.5 cm

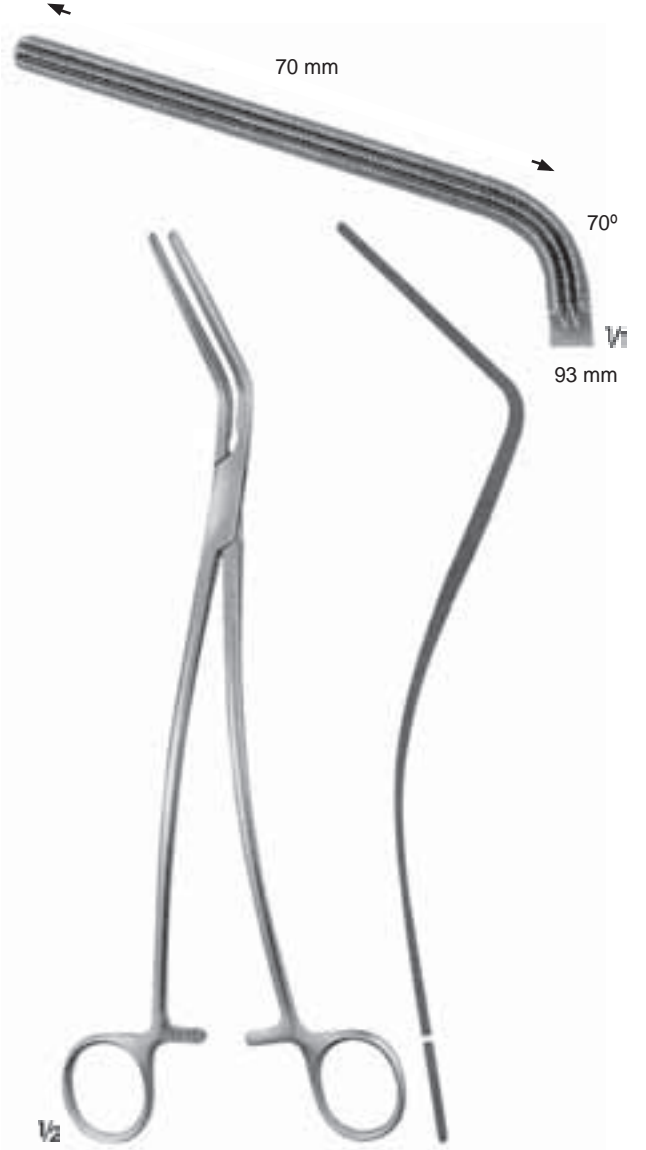

70 mm

70°

93 mm

V₂

DE BAKEY (MORRIS modif.)
H 461.00
24 cm

De Bakey Diş



Toothing De BAkey



H 477.00
70 mm

H 477.01
75 mm

H 477.02
85 mm



H 476.00

HAGMÜLLER
H 476.00
27 cm



DE BAKEY
H 477.00 25.5 cm
H 477.01 26.5 cm
H 477.02 28 cm

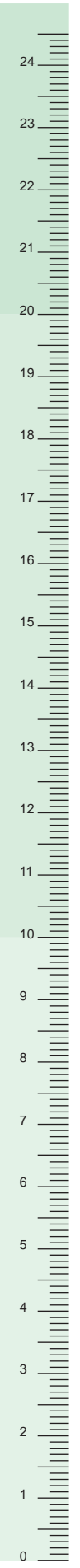

De Bakey Diş



Toothing De BAkey



DE BAKEY (SEMB modif.)
H 480.00
26.5 cm



DE BAKEY
H 481.00
27 cm

De Bakey Diş



Toothing De BAkey

2 x 3 diş



2 x 3 teeth

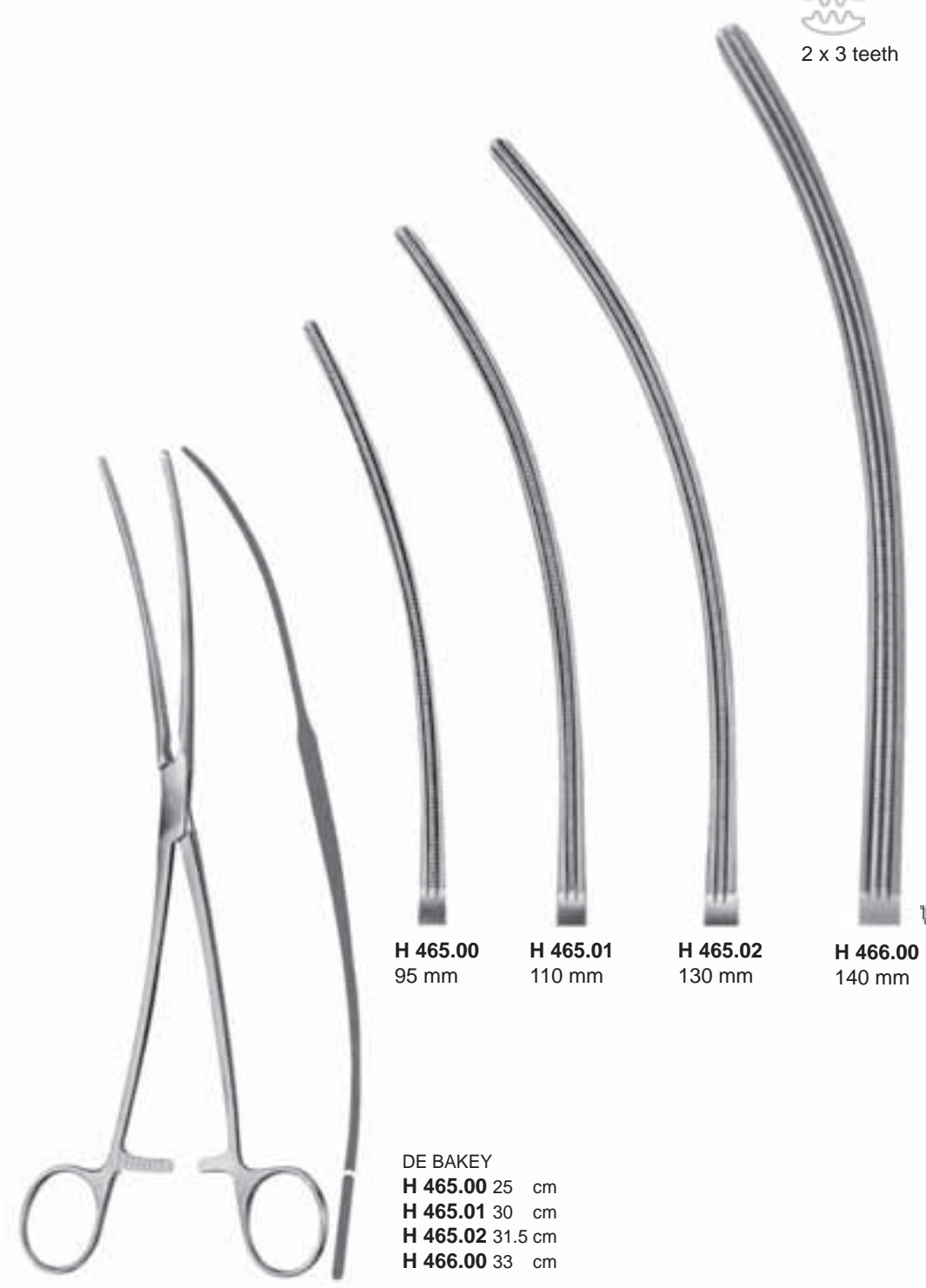

H 465.00
95 mm

H 465.01
110 mm

H 465.02
130 mm

H 466.00
140 mm

DE BAKEY

H 465.00 25 cm

H 465.01 30 cm

H 465.02 31.5 cm

H 466.00 33 cm

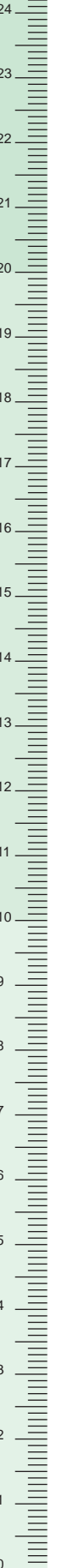



Aort Anevrizma Klempleri
Aorta Aneurysm Clamps

Atromatik
Atraumatic

De Bakey Diş



Toothing De BAkey



DE BAKEY
H 474.00
28 cm



DE BAKEY
H 478.00
30 cm

V1
115 mm

De Bakey Diş



Toothing De BAkey

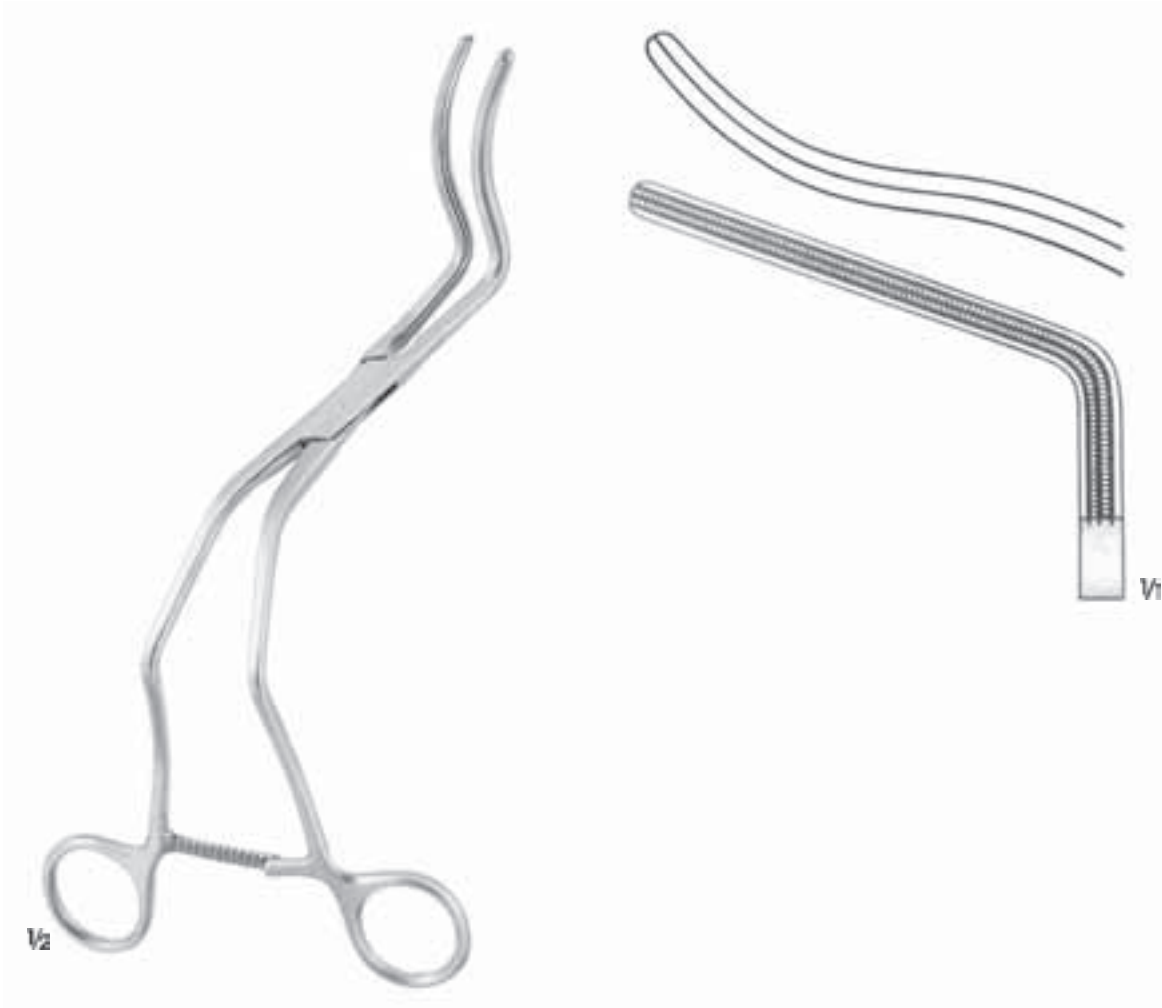

GRANT
H 475.00
24.5 cm

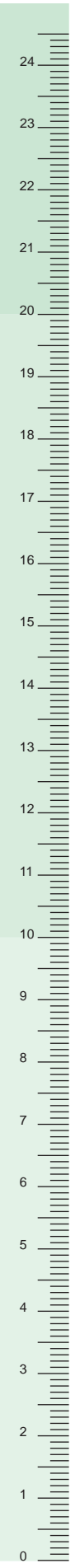

De Bakey Diş



Toothing De BAkey



DIETRICH
H 488.00
21 cm



OCHSNER
H 489.00
26 cm

De Bakey Diş



Toothing De BAkey

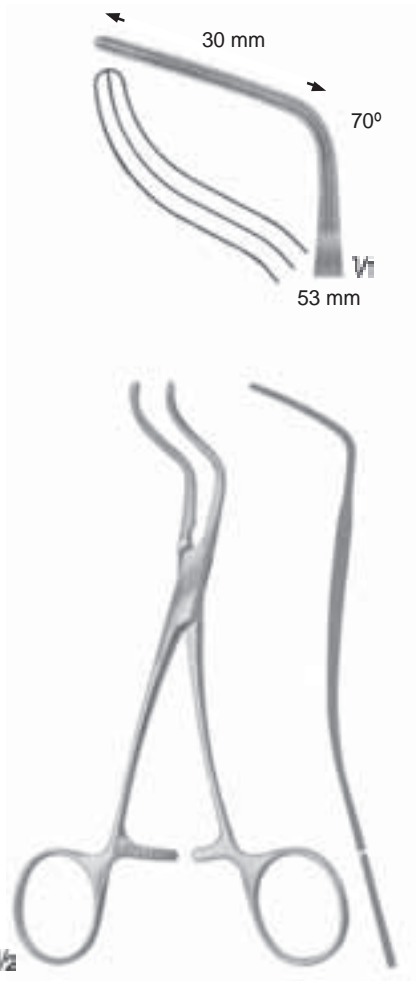

SUBRAMANIAN (modif.)
H 576.00
15.5 cm

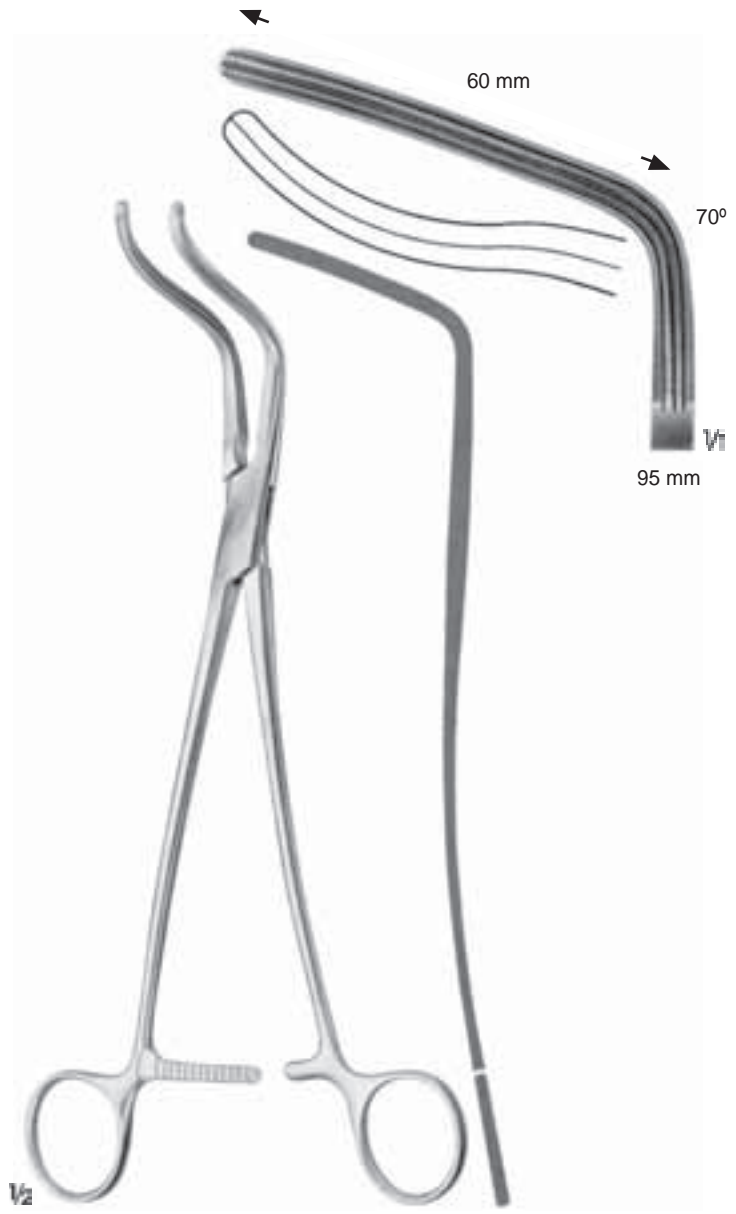

DE BAKEY
H 577.00
26.5 cm

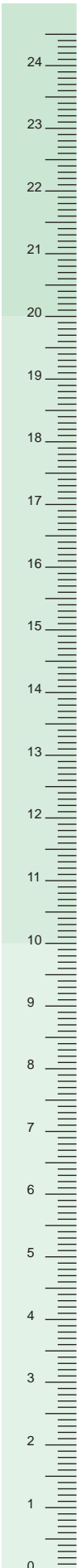

De Bakey Diş



Toothing De BAkey

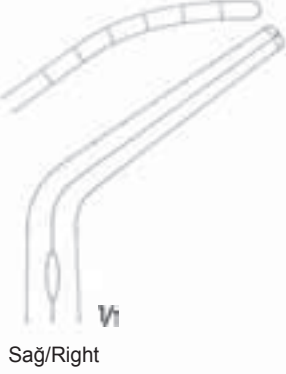

**SUBRAMANIAN
H 467.00**
Çocuklar İçin Aort Klempleri
Pediatric Aorta Clamp
16 cm



**SUBRAMANIAN
H 468.00**
Çocuklar İçin Aort Klempleri
Pediatric Aorta Clamp
16 cm



**ZANGER
H 470.00 - H 470.02**
Aort Klempleri/Aorta Clamp



H 470.00
21.5 cm

H 470.01
25 cm

H 470.02
30.5 cm



**MITCHELL
H 469.00**
Aort Klempleri/Aorta Clamp
20 cm

De Bakey Diş



Toothing De BAkey

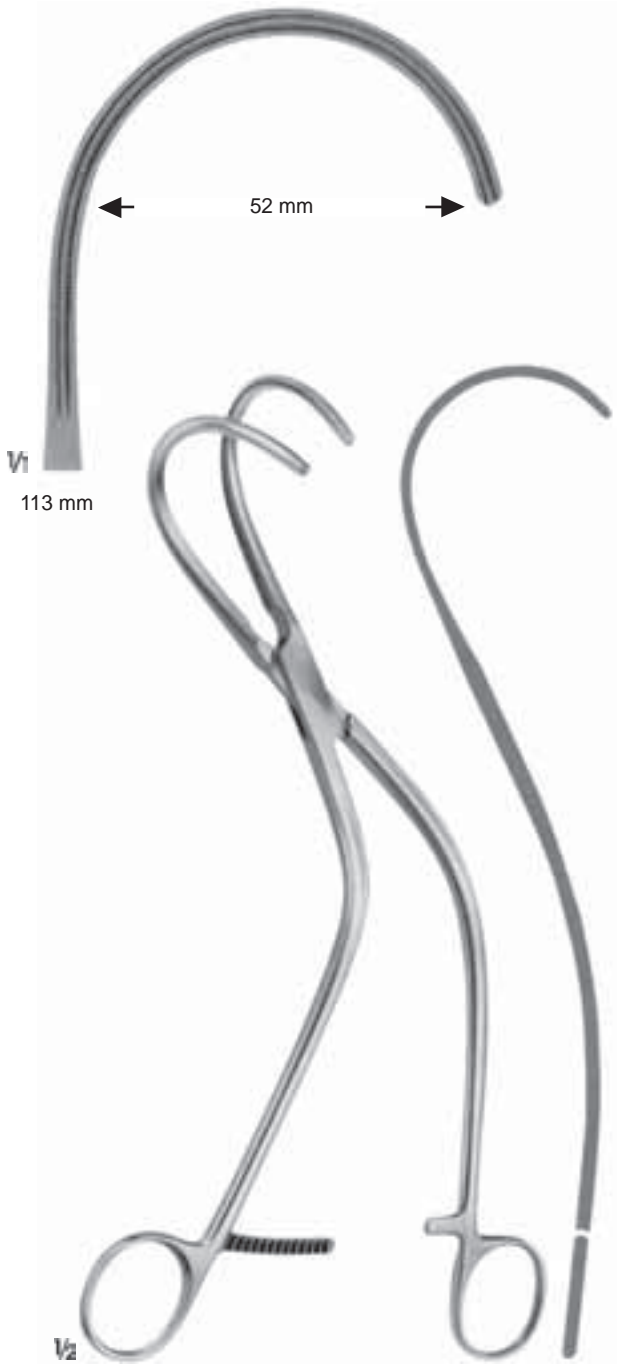

WEBER
H 484.00
Sol/Left
26 cm



WEBER
H 485.00
Sağ/Right
26 cm

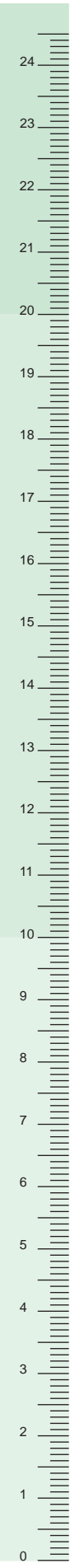

De Bakey Diş



Toothing De BAkey

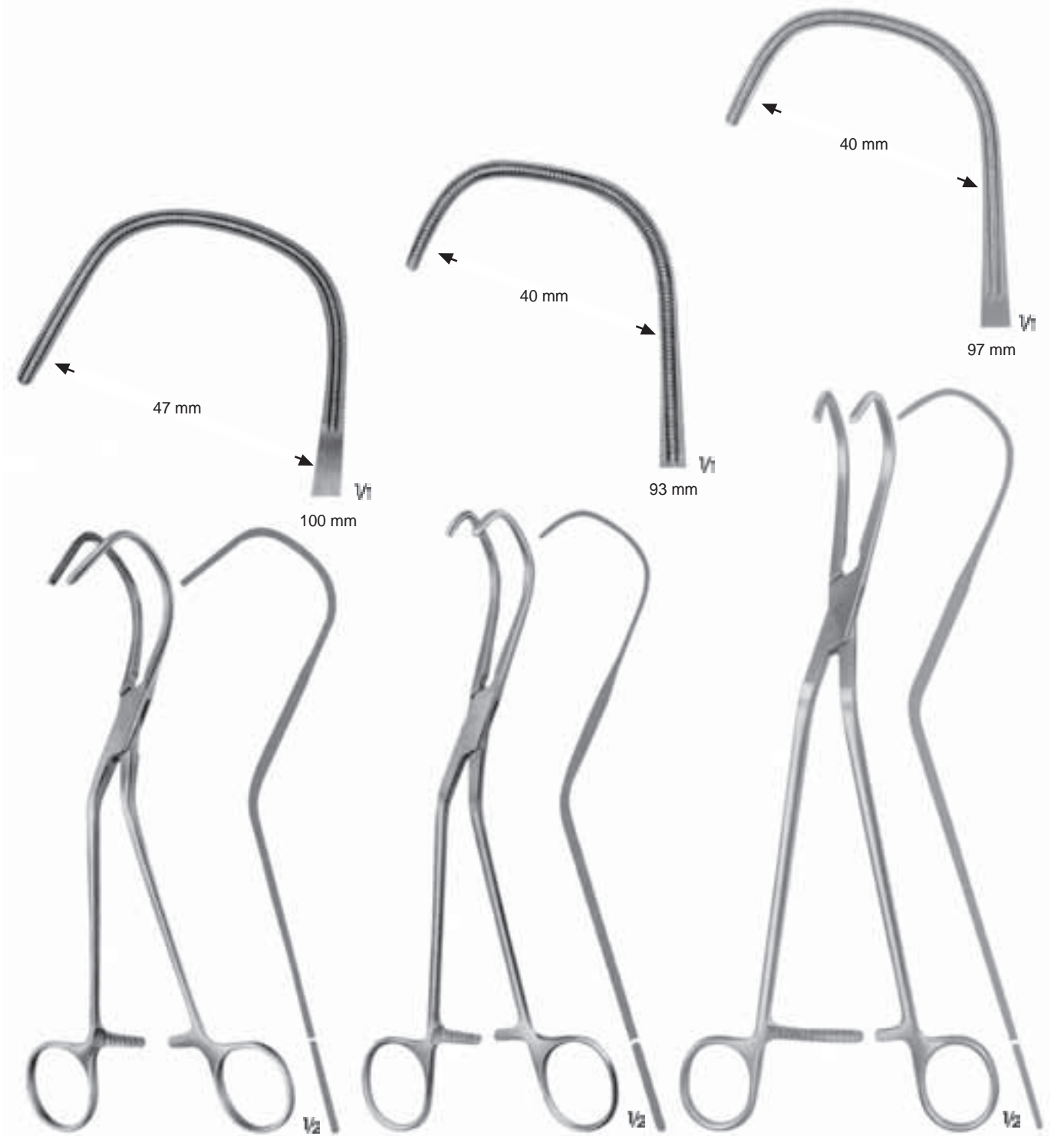

LAMBERT-KAY
H 486.01
21 cm

LAMBERT-KAY
H 486.00
21.5 cm

DE BAKEY(LAMBERT Modif.)
H 487.00
25.5 cm

De Bakey Diş



Toothing De BAkey



95 mm



97 mm



LEES
H 573.00
24.5 cm



ATLEE
H 574.00
24.5 cm

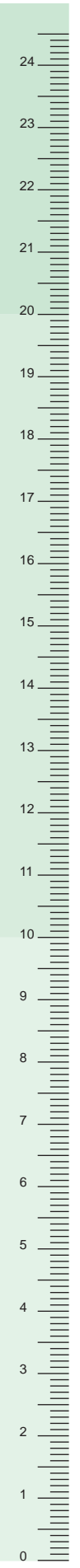

De Bakey Diş



Toothing De BAkey



LEES
H 572.00
22 cm



LEES
H 572.02
25 cm

De Bakey Diş



Toothing De BAkey



H 440.00
51 mm

DE BAKEY
H 440.00 21 cm
H 440.01 23 cm



H 440.01
75 mm

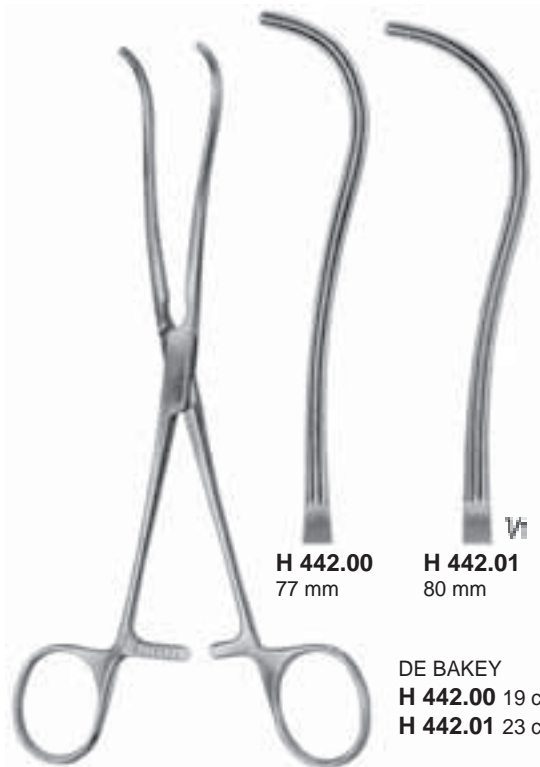

H 442.00
77 mm

H 442.01
80 mm

DE BAKEY
H 442.00 19 cm
H 442.01 23 cm



H 444.00
70 mm

DE BAKEY-MC
QUIGG-MIXTER
H 444.00
21 cm

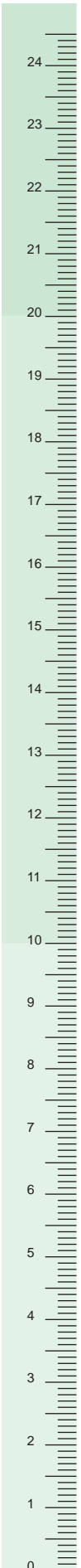

De Bakey Diş



Toothing De BAkey



81 mm



81 mm



80 mm



DE BAKEY-RUMEL
H 447.00
25 cm



DE BAKEY-RUMEL
H 446.00
24.5 cm



DE BAKEY-MIXTER
H 449.00
28.5 cm

De Bakey Diş



Toothing De BAkey



DE BAKEY
H 445.00
24 cm



DE BAKEY
H 483.00
24 cm

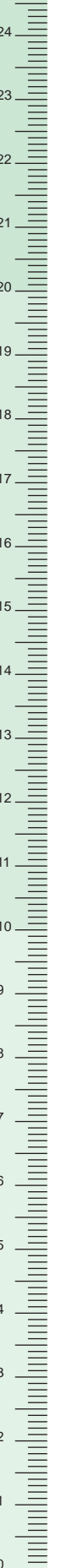

De Bakey Diş



Toothing De BAkey

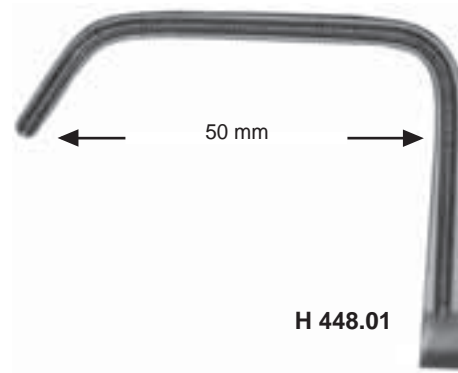
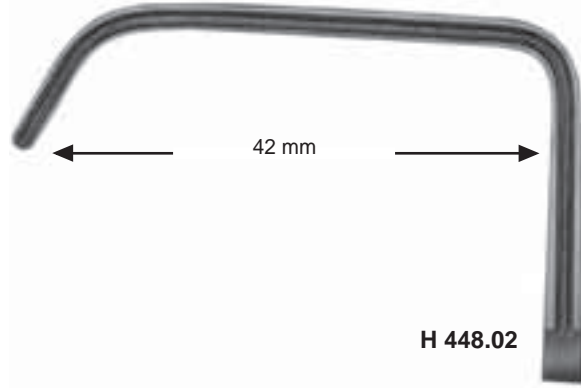

HOPT
H 448.00 23 cm
H 448.01 23.5 cm
H 448.02 24.5 cm

De Bakey Diş



Toothing De BAkey

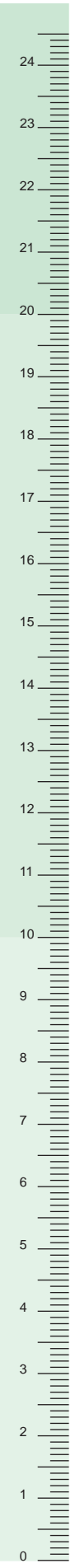
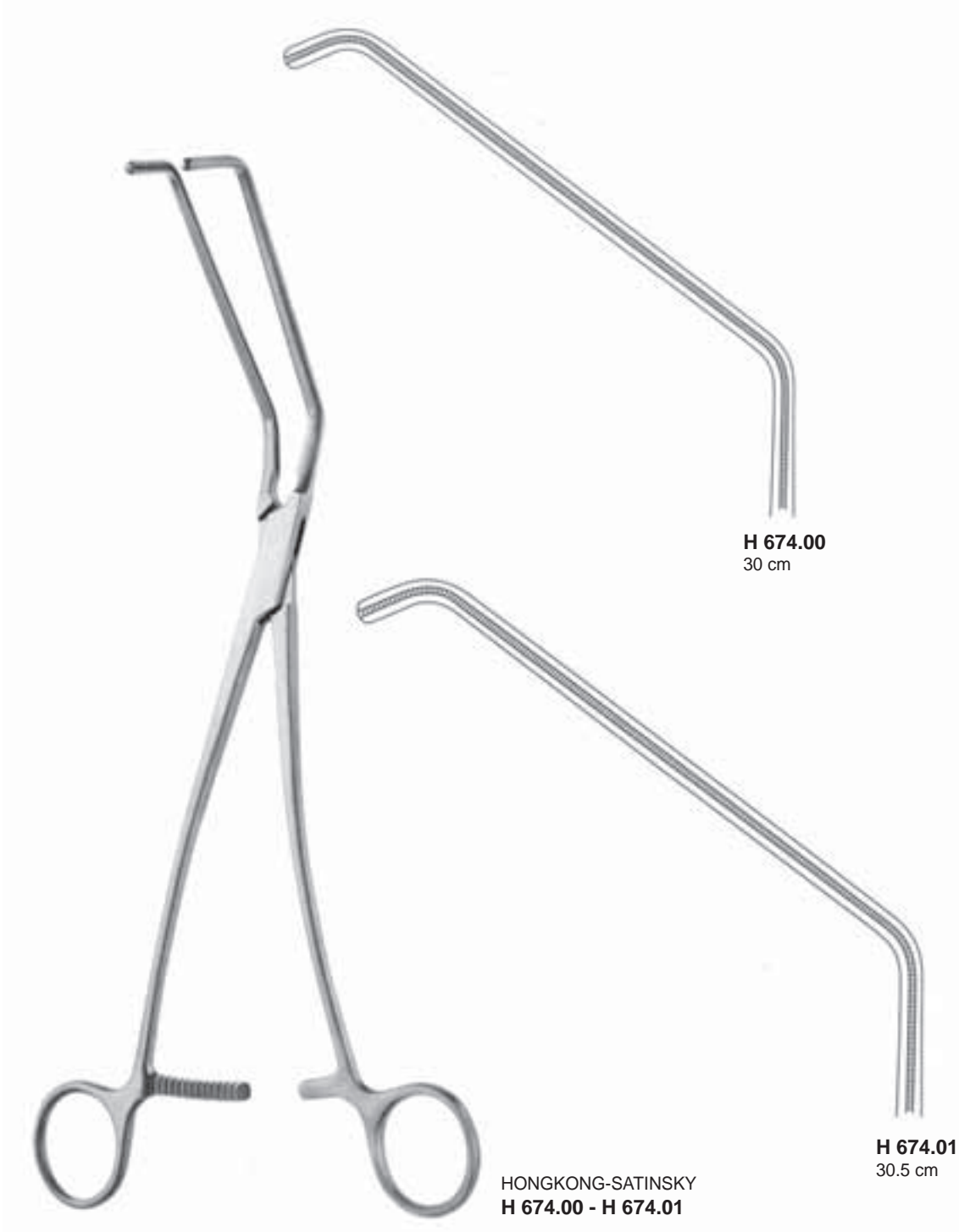

De Bakey Diş



Toothing De BAkey



CALNE
H 675.00
27 cm

De Bakey Diş



Toothing De BAkey

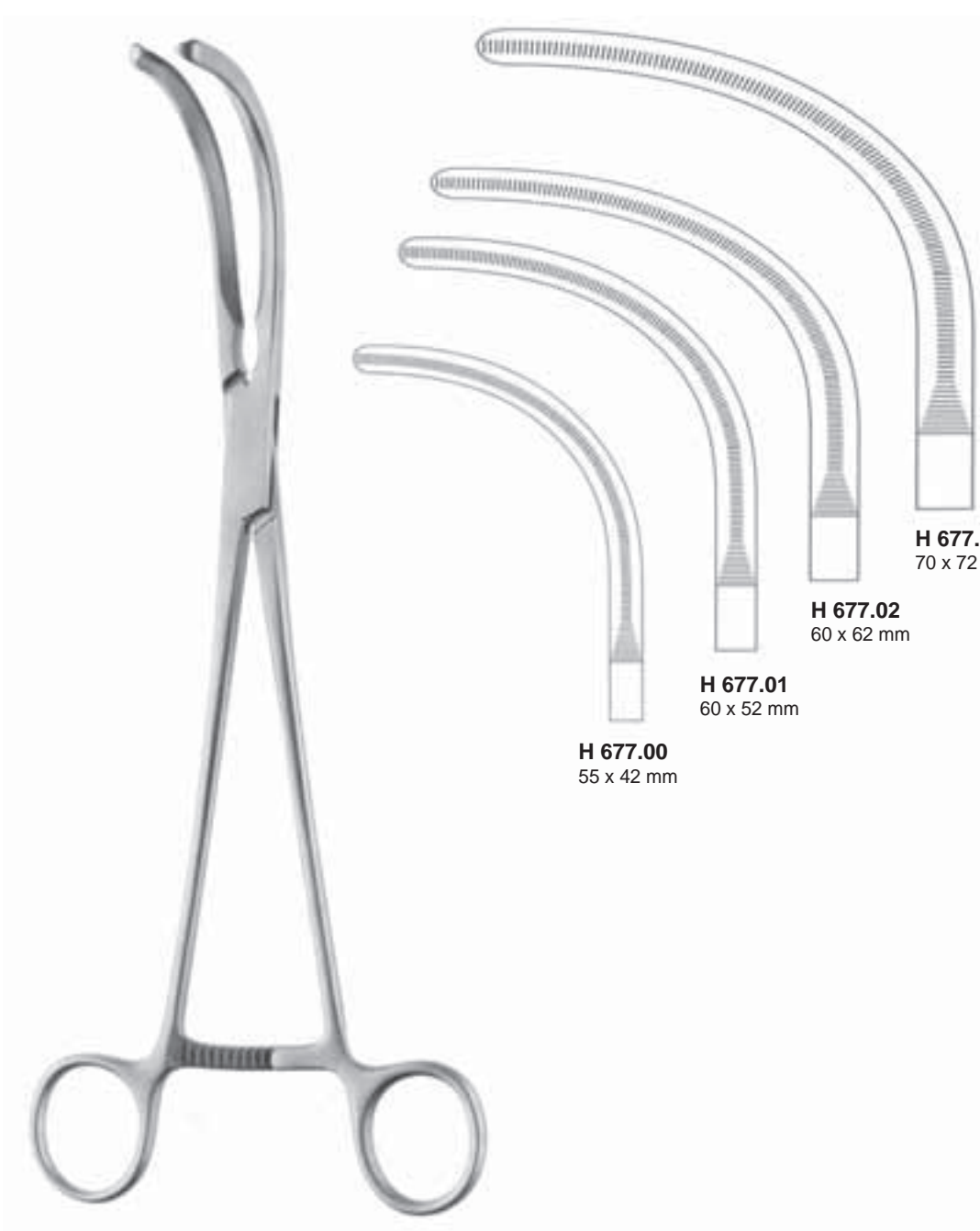

POTTS
H 677.00 25 cm
H 677.01 26 cm
H 677.02 27 cm
H 677.03 27 cm

H 677.03
70 x 72 mm

H 677.02
60 x 62 mm

H 677.01
60 x 52 mm

H 677.00
55 x 42 mm

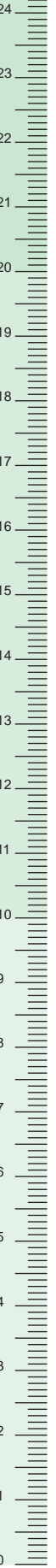

De Bakey Diş



Toothing De BAkey



De Bakey Diş



Toothing De BAkey



H 200.00
78 mm

H 200.01
88 mm

H 200.02
98 mm



DICK
H 200.00 25.5 cm
H 200.01 26.5 cm
H 200.02 27.5 cm

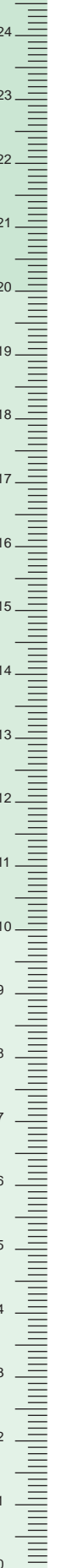

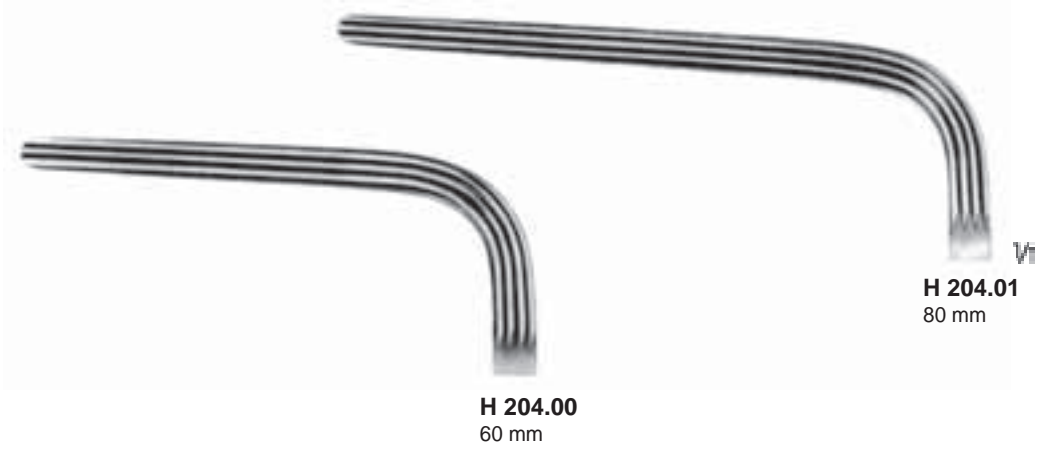

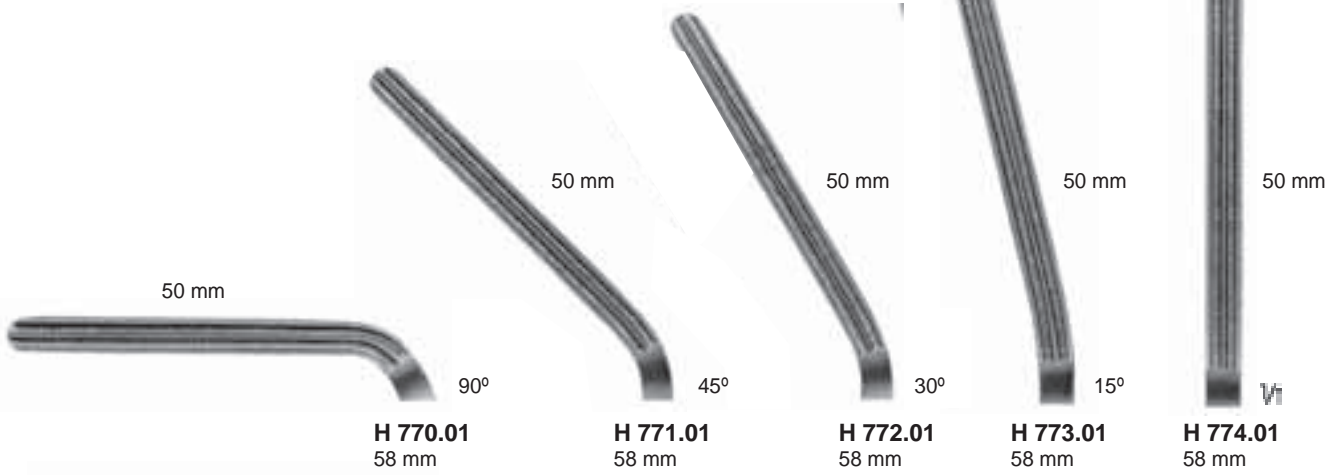
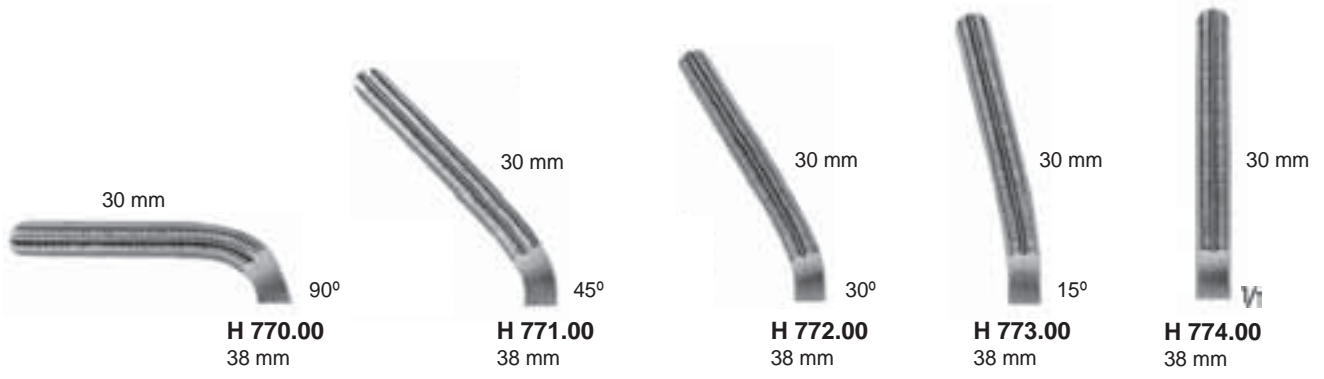

DARDIK

H 770.00 13 cm
H 771.00 14.5 cm
H 772.00 15 cm
H 773.00 15 cm
H 774.00 15 cm

DARDIK

H 770.01 13.5 cm
H 771.01 16 cm
H 772.01 17 cm
H 773.01 17 cm
H 774.01 17 cm

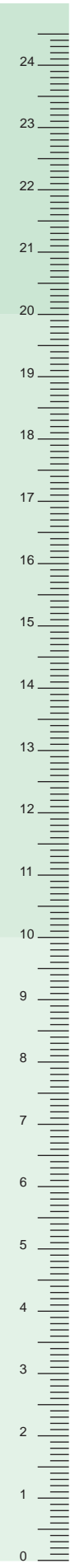

Cooley Diş



Toothing Cooley



H 600.00
50 mm

H 601.00
50 mm

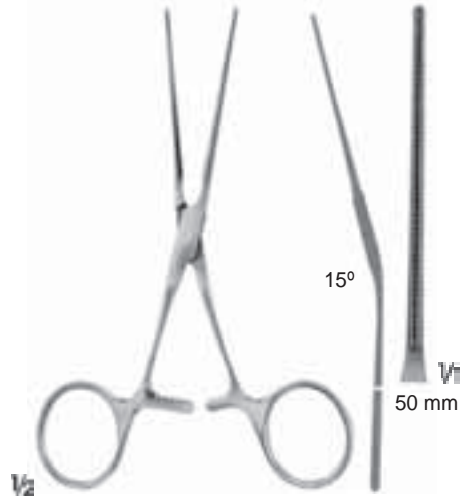

15°

H 602.00
50 mm

COOLEY
H 600.00 12.5 cm
H 601.00 11.5 cm

COOLEY
H 602.00
12.5 cm



41 mm

90°

52 mm

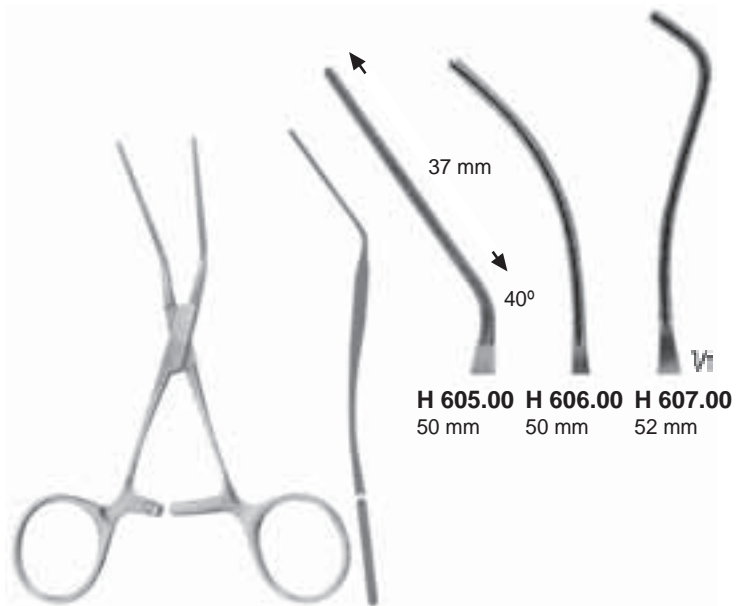

37 mm

40°

H 605.00
50 mm

H 606.00
50 mm

H 607.00
52 mm

COOLEY
H 604.00
10 cm

COOLEY
H 605.00 12 cm
H 606.00 12.5 cm
H 607.00 12.5 cm

Cooley Diş



Toothing Cooley



H 608.00
50 mm

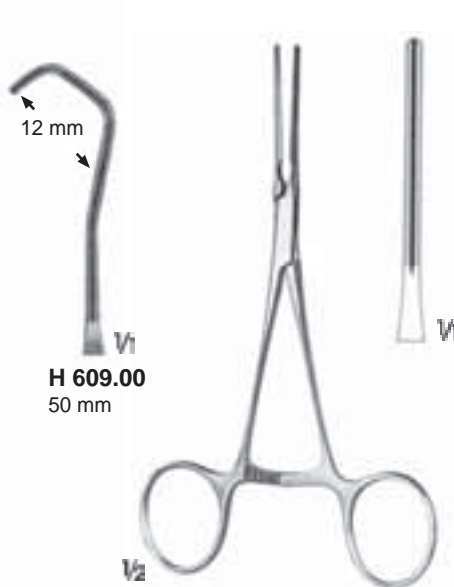

12 mm
H 609.00
50 mm



COOLEY
H 610.00
14 cm

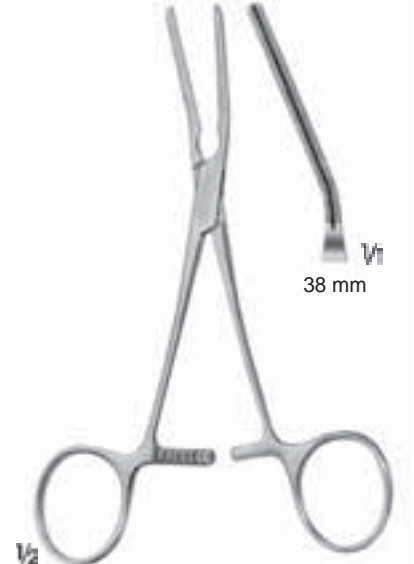

COOLEY
H 611.00
14.5 cm

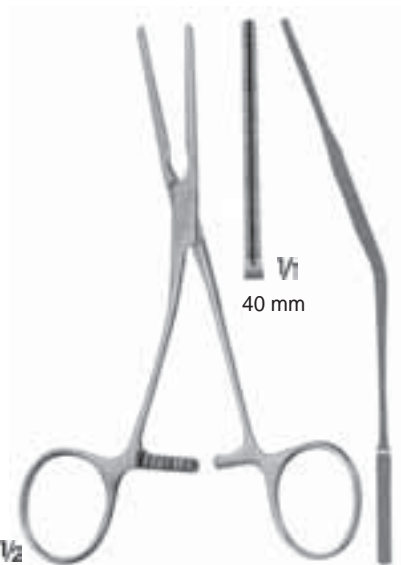

COOLEY
H 612.00
14 cm

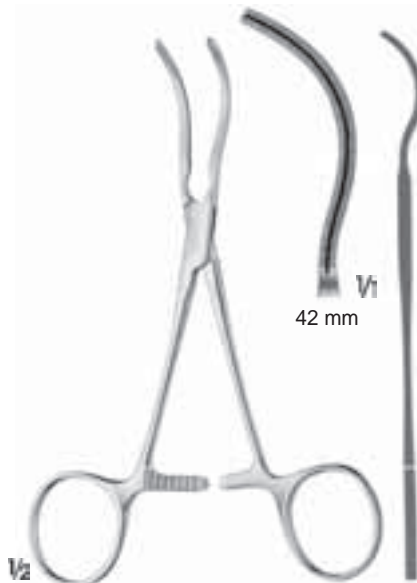

COOLEY
H 613.00
14.5 cm



COOLEY
H 614.00
14 cm

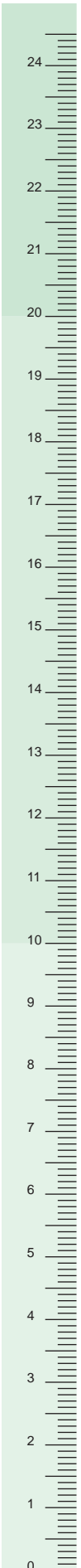

De Bakey Diş



Toothing De BAkey



DE BAKEY-PEAN
H 616.00 - H 616.04



H 616.00
14 cm



H 616.01
16 cm



H 616.03
18 cm



H 616.04
20 cm

Vt



DE BAKEY-PEAN
H 617.00 - H 617.04

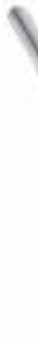

H 617.00
14 cm



H 617.01
16 cm



H 617.03
18 cm



H 617.04
20 cm

Vt

Cooley Diş



Toothing Cooley

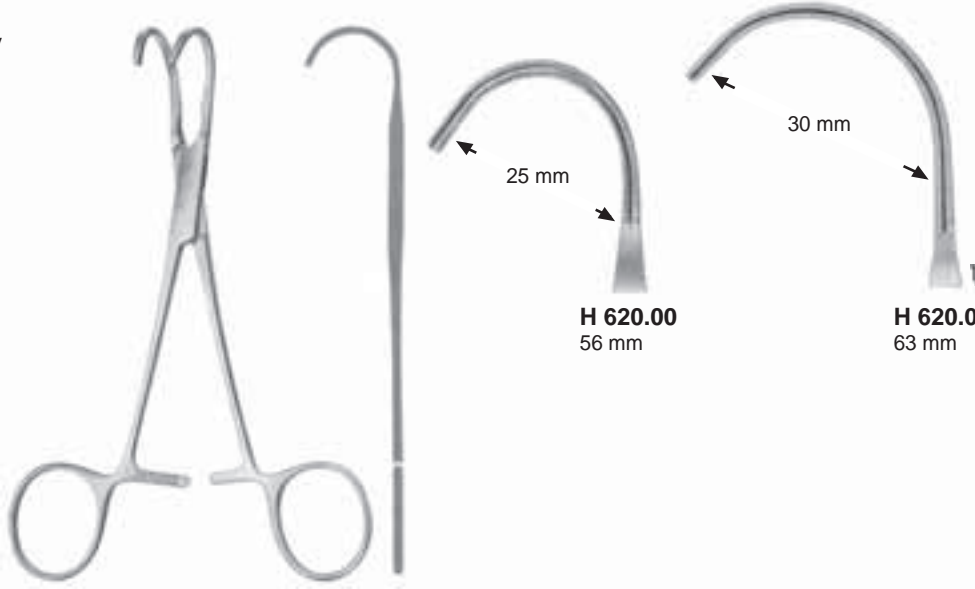

COOLEY-BECK
H 620.00 15 cm
H 620.01 15.5 cm

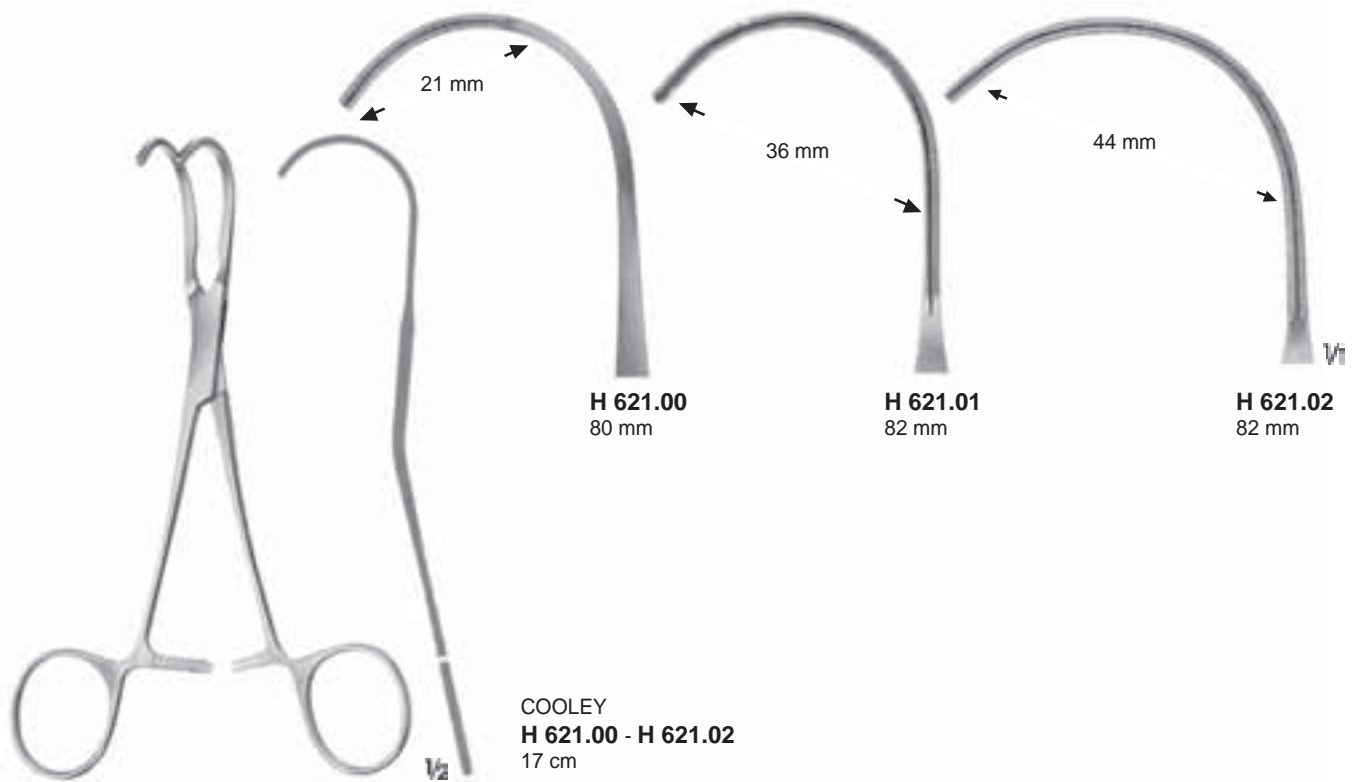

COOLEY
H 621.00 - H 621.02
17 cm

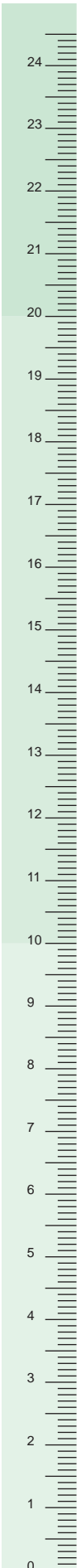

Cooley Diş



Toothing Cooley



V₂

BECK
H 632.00
17 cm



V₂

COOLEY
H 633.00
17 cm

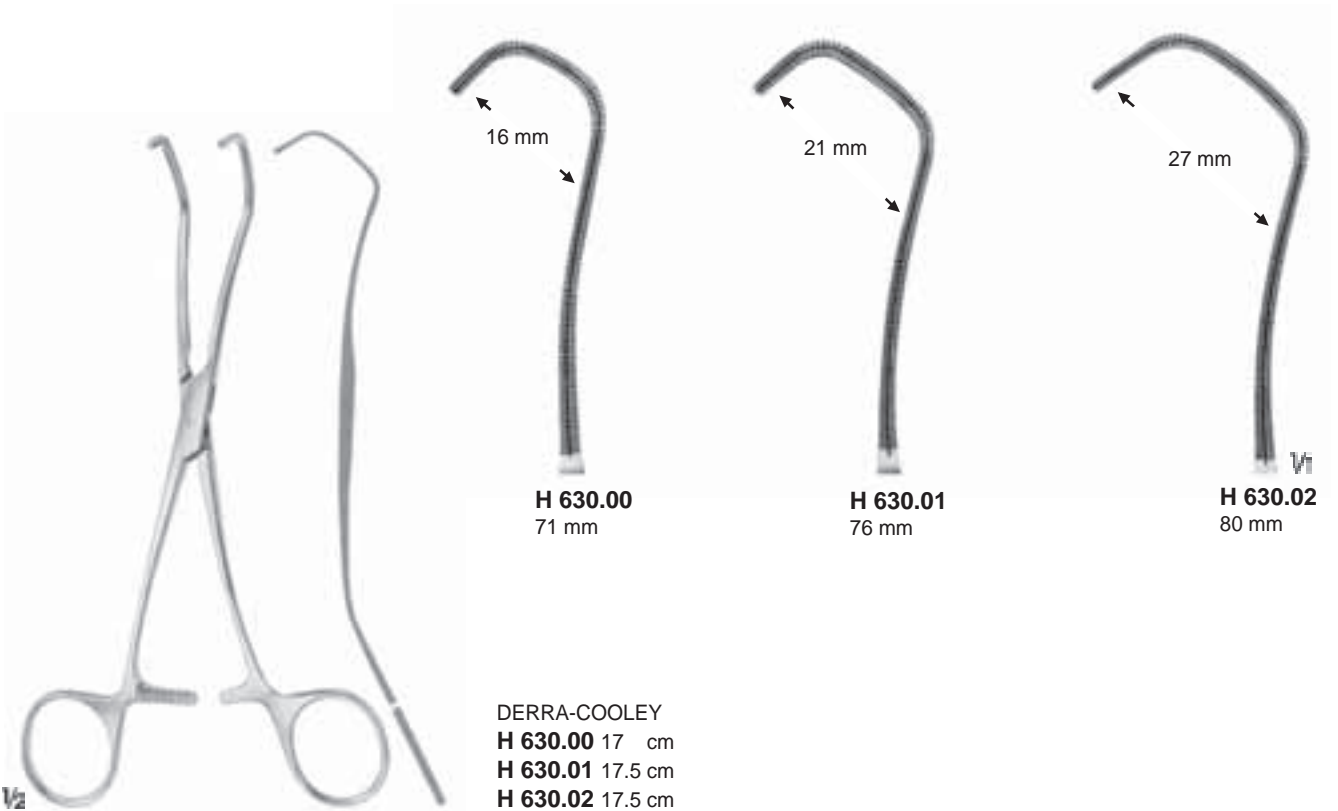

V₂

DERRA-COOLEY
H 630.00 17 cm
H 630.01 17.5 cm
H 630.02 17.5 cm

H 630.00
71 mm

H 630.01
76 mm

H 630.02
80 mm

Cooley Diş



Toothing Cooley



LEITZ
H 643.00
20.5 cm



PARRY-COOLEY
H 644.00
29.5 cm

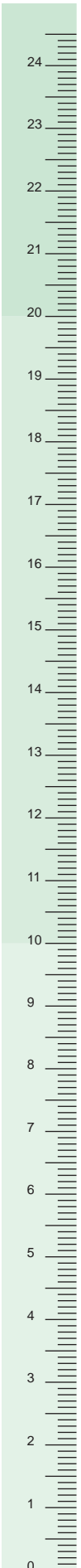

Cooley Diş



Toothing Cooley

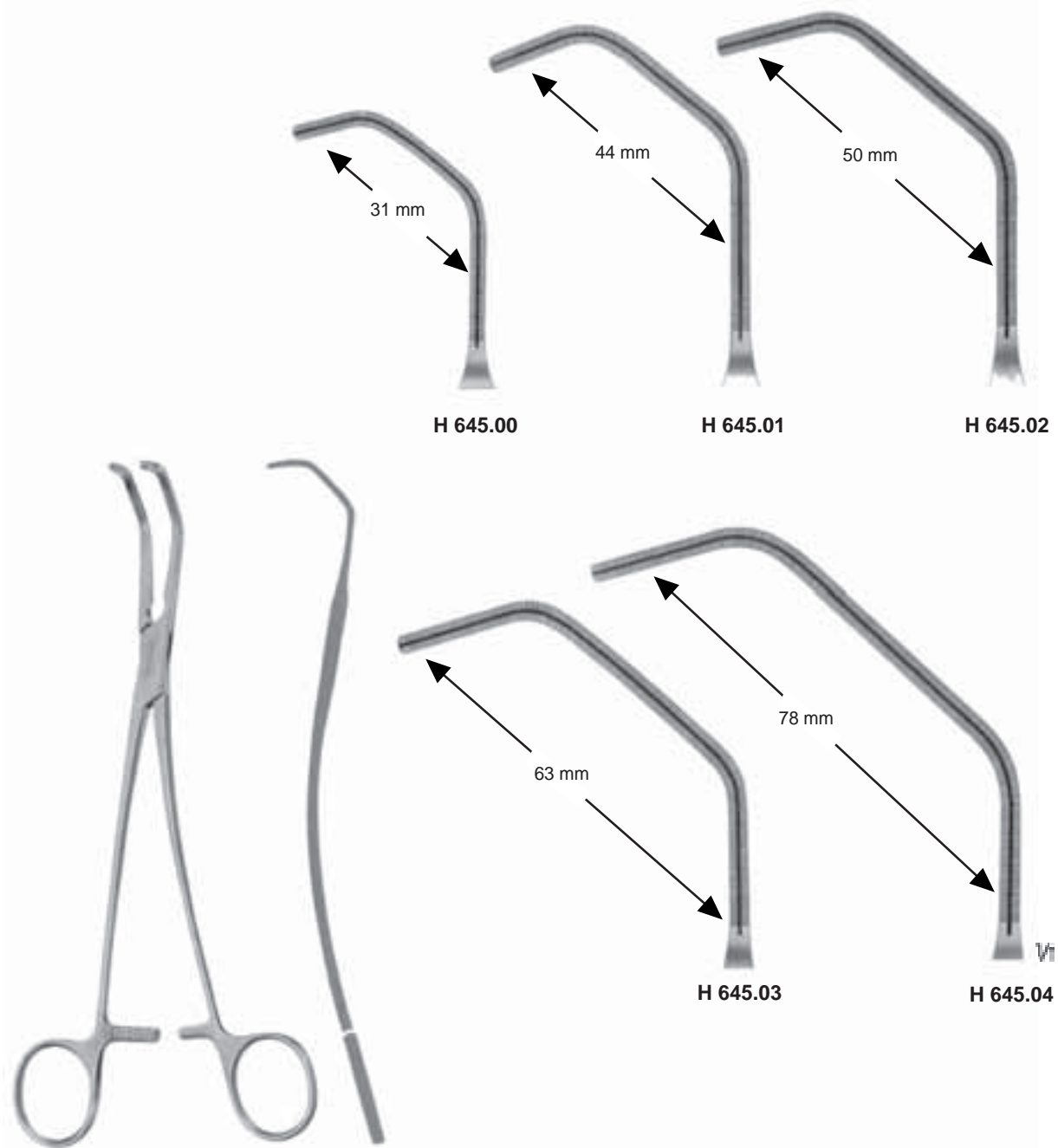

COOLEY

H 645.00 20.5 cm

H 645.01 26 cm

H 645.02 26.5 cm

H 645.03 26.5 cm

H 645.04 27.5 cm

Cooley Diş



Toothing Cooley



COOLEY
H 631.00 16.5 cm
H 631.01 16.5 cm
H 631.02 17.5 cm
H 631.03 18 cm

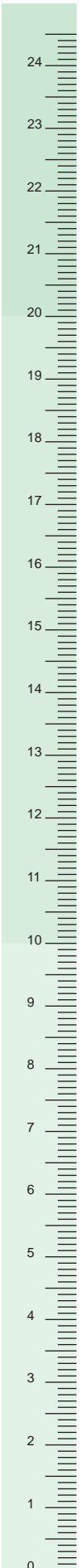

Cooley Diş



Toothing Cooley

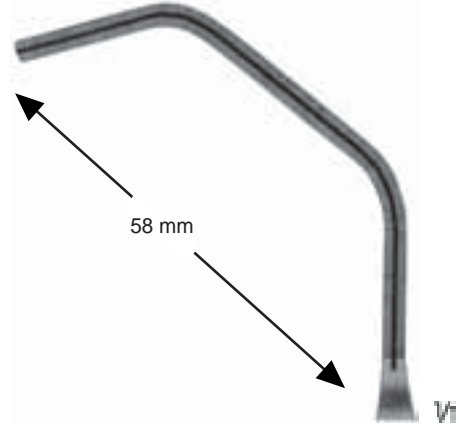

COOLEY
H 647.00
26 cm

Cooley Diş



Toothing Cooley

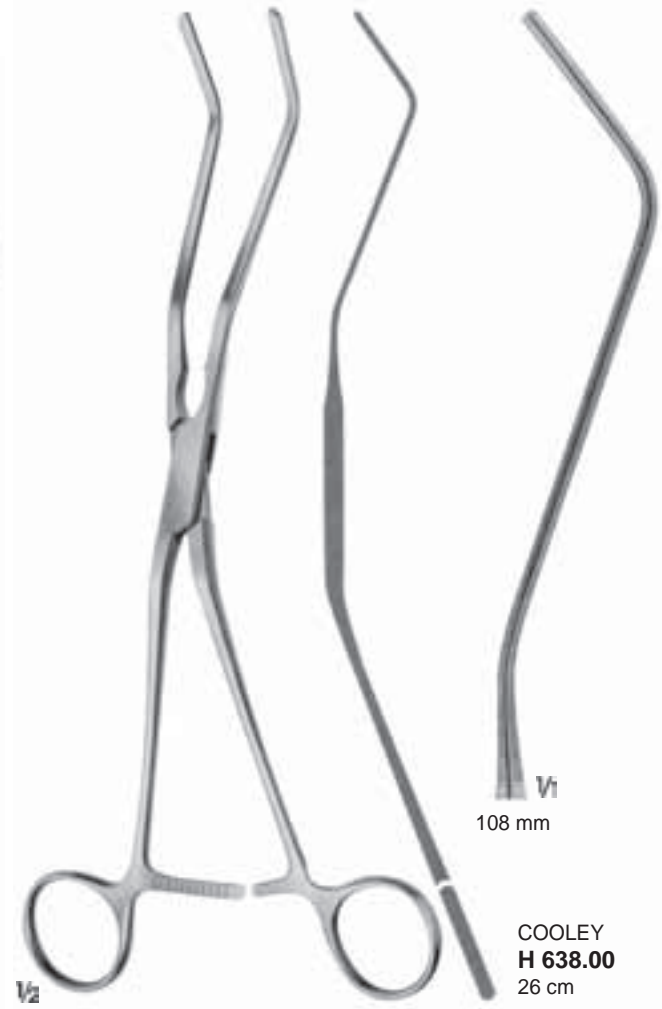
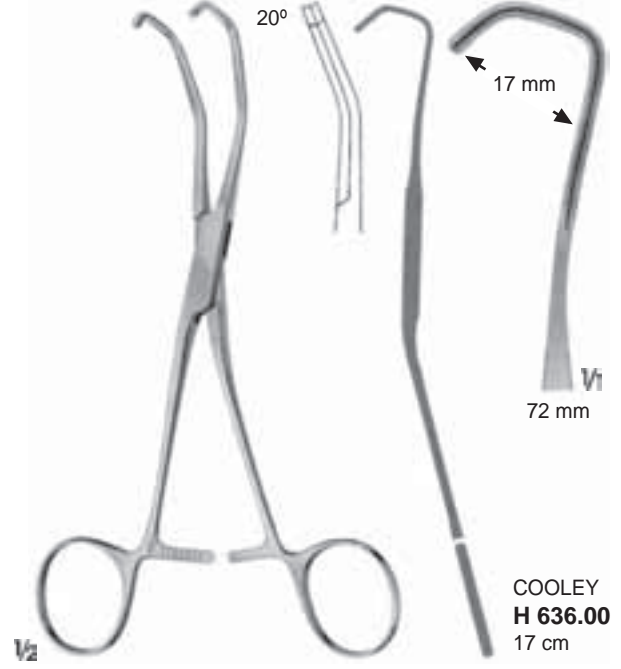
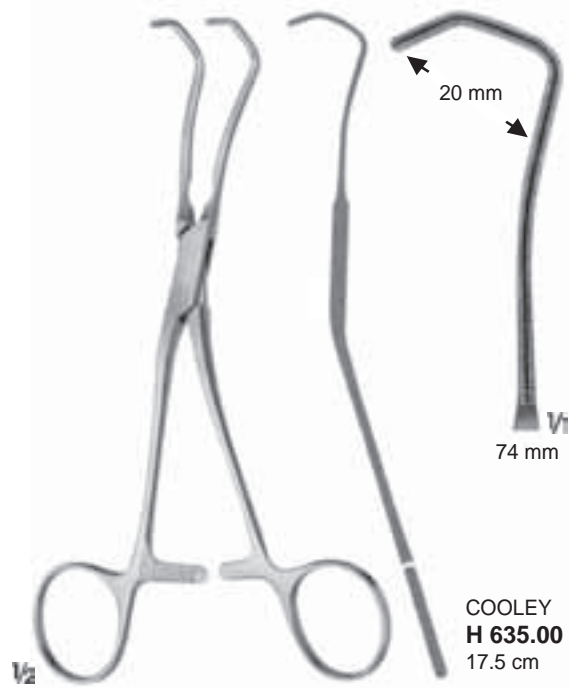

Cooley Diş



Toothing Cooley

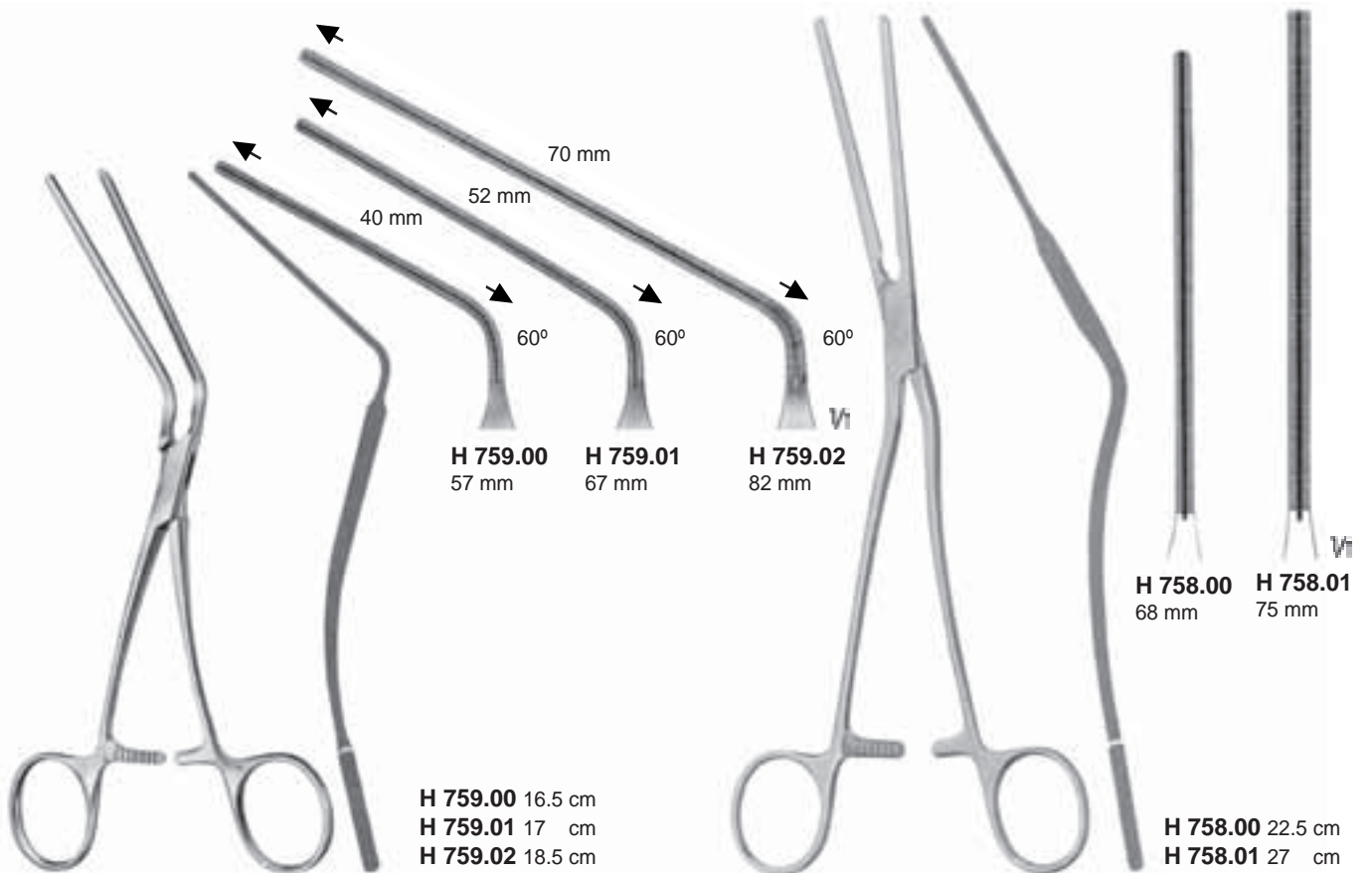
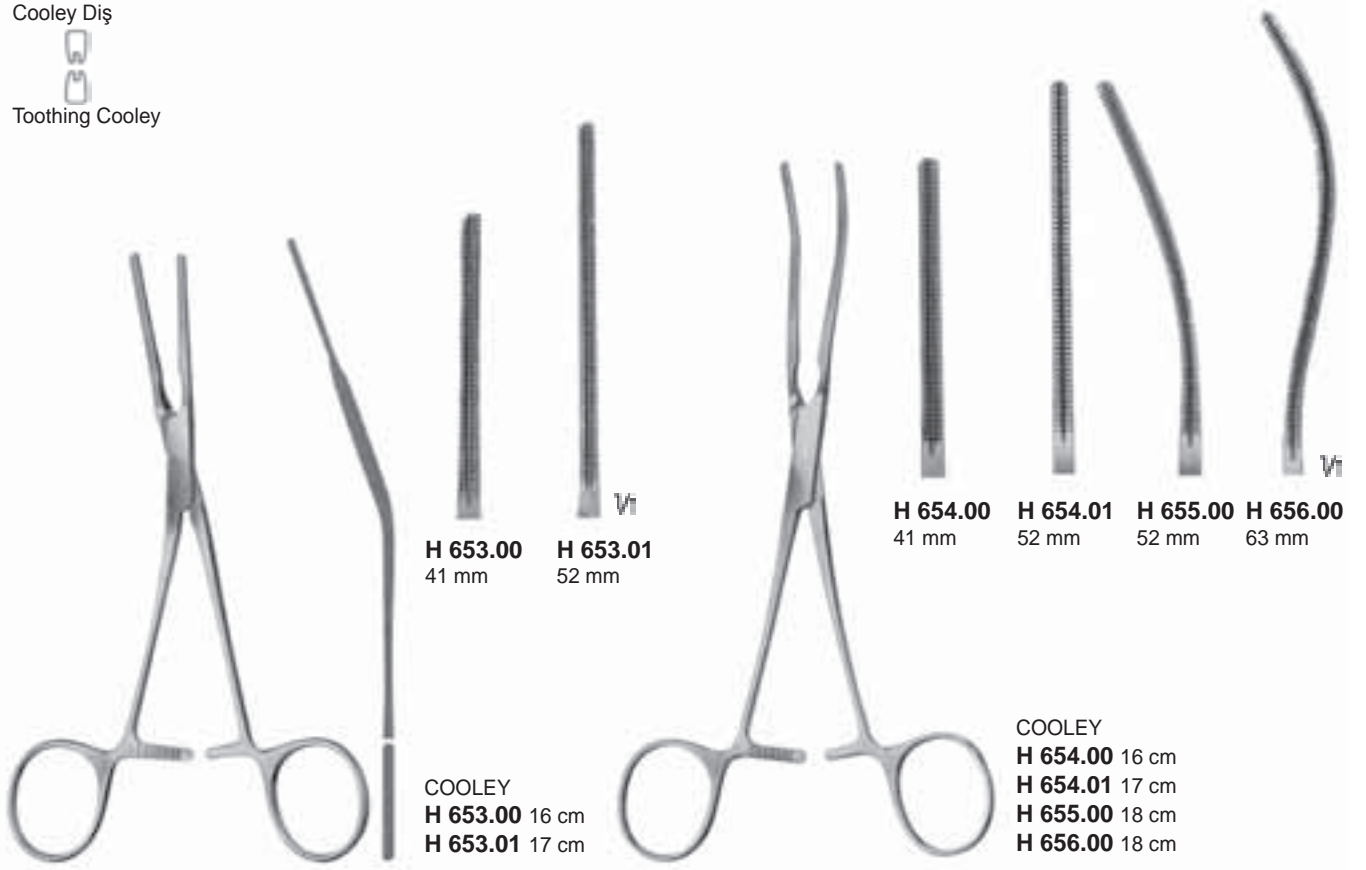

Cooley Diş



Toothing Cooley

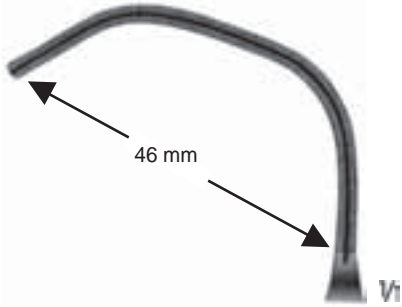

**COOLEY
H 755.00**
22 cm



**COOLEY
H 756.00**
28.5 cm

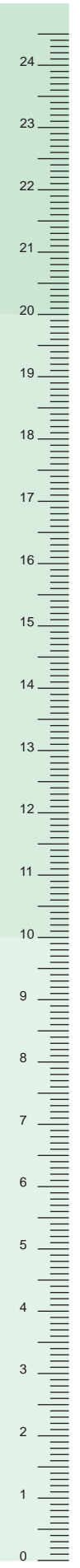

Cooley Diş



Toothing Cooley



1/2

COOLEY
H 757.00
32 cm

1/1
115 mm

Cooley Diş



Toothing Cooley

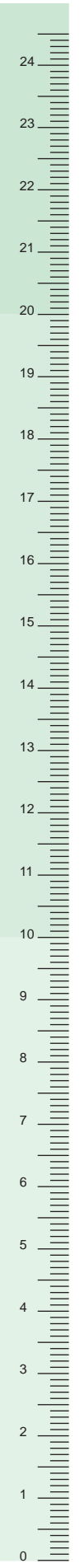
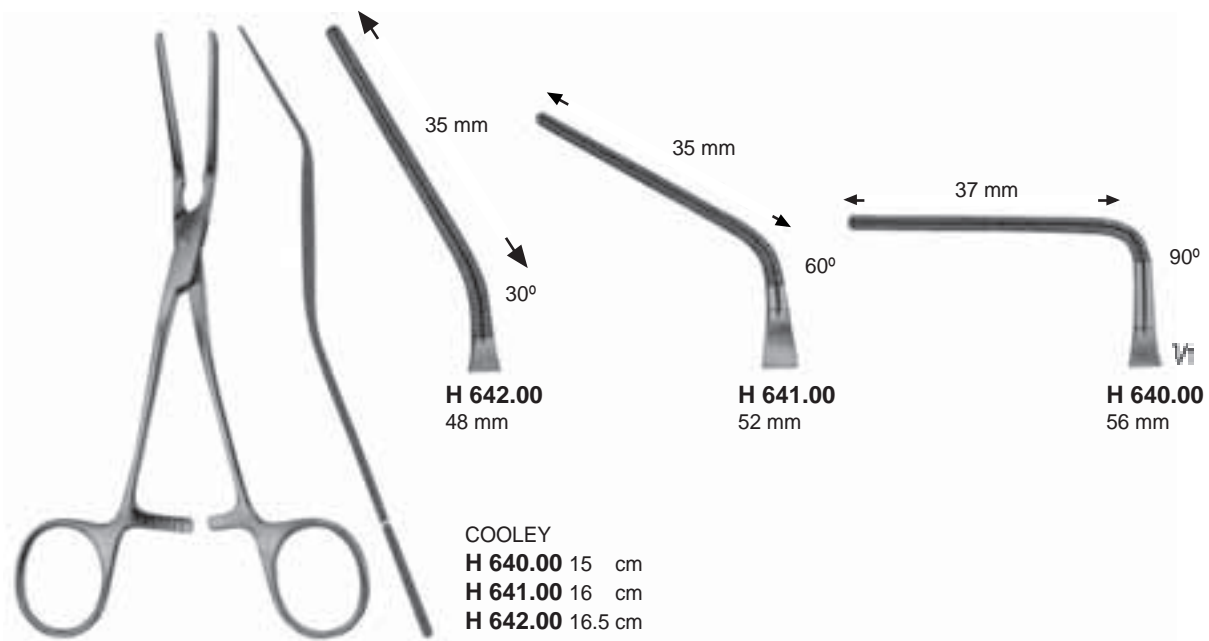
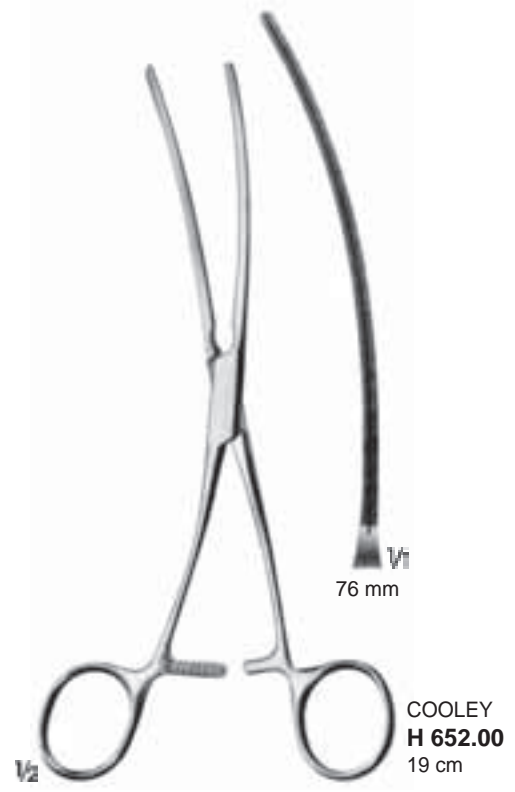
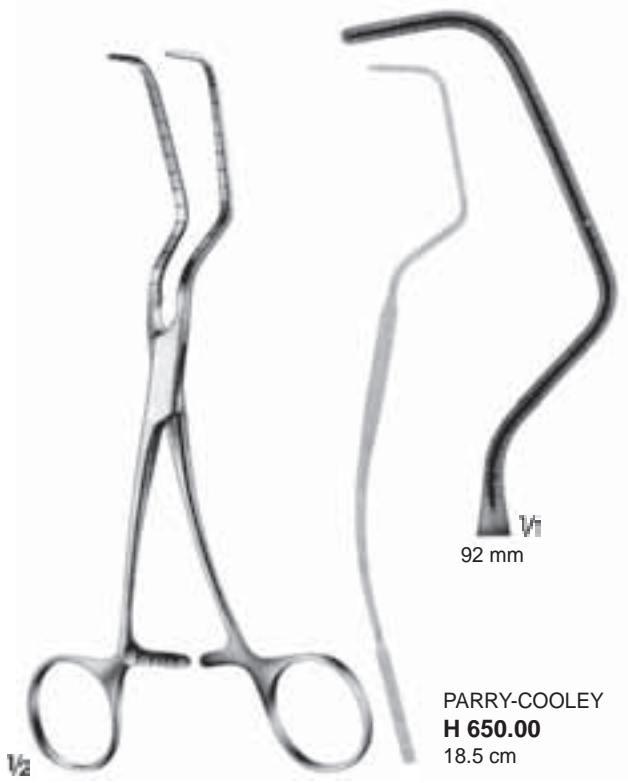

Cooley Diş



Toothing Cooley



V₂

H 680.00
16.5 cm



V₂

H 681.00
16.5 cm

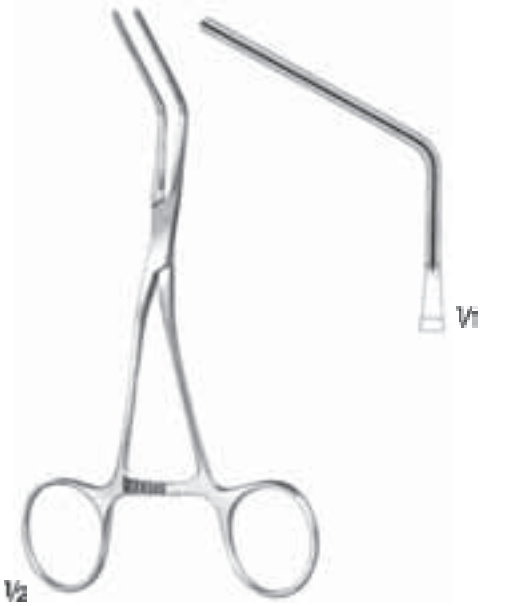

V₂

H 682.00
15.5 cm



V₂

H 683.00
15.5 cm



V₂

H 684.00
16 cm

Cooley Diş



Toothing Cooley



H 603.00
14 cm



H 603.01
14 cm



H 603.02
14 cm



H 603.03
13 cm



H 603.05
14 cm



H 603.07
13 cm



H 603.08
13 cm



H 603.11
14 cm



H 603.12
13.5 cm



H 603.00 - H 603.12

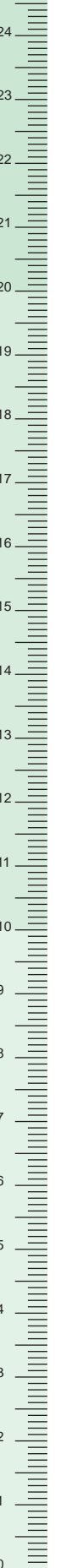

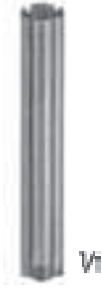

H 705.00

H 700.00 H 701.00 H 702.00 için silikon
Silicone for H 700.00 H 701.00 H 702.00
1 paket 12 adet/Package of 12 pieces

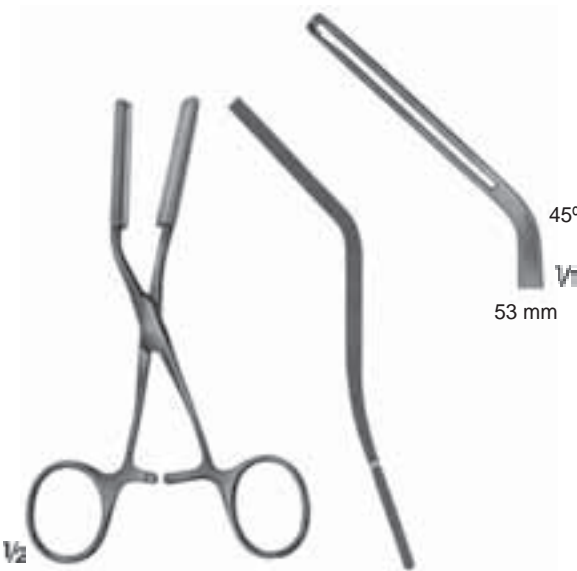

**V₂**

MÜLLER
H 707.00 20 cm
H 709.00 ile birlikte kullanılır.
Used with H 709.00

**V₂**

MÜLLER
H 706.00 18 cm
H 709.00 ile birlikte kullanılır.
Used with H 709.00

MÜLLER
H 709.00
H 706.00 - H 714.00 için silikon
Silicone for H 706.00 - H 714.00
1 paket 12 adet/Package of 12 pieces

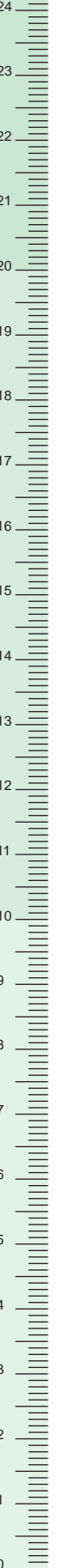



110 mm



115 mm



V2

MÜLLER
H 710.00 30 cm
H 709.00 ile birlikte kullanılır.
Used with H 709.00

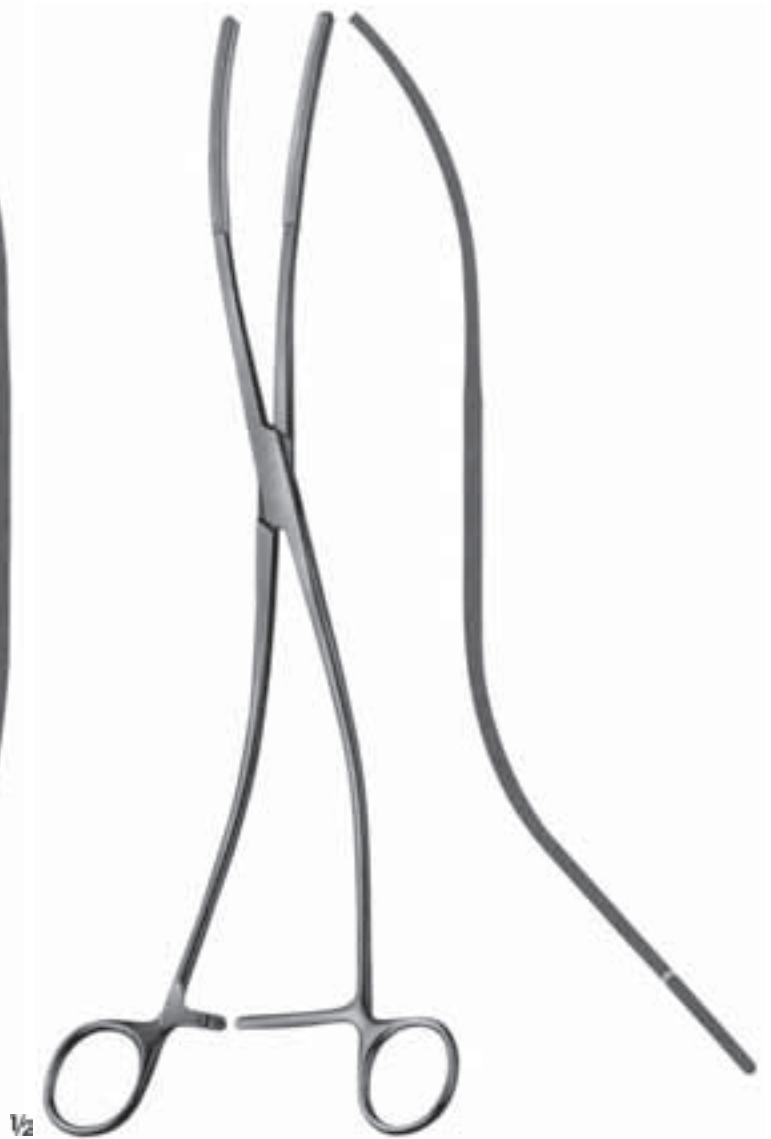

V2

MÜLLER
H 711.00 30 cm
H 709.00 ile birlikte kullanılır.
Used with H 709.00

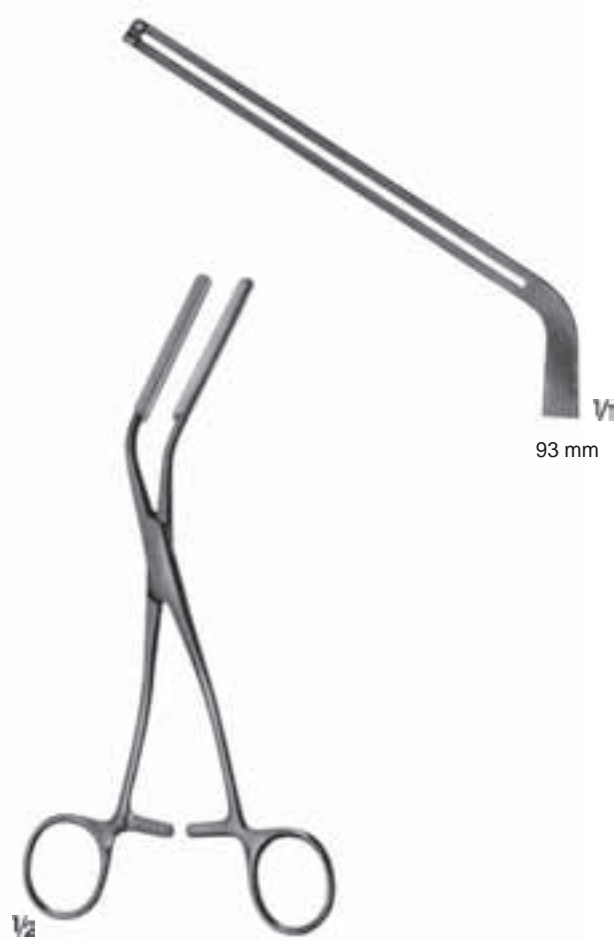

MÜLLER
H 713.00 17.5 cm
H 709.00 ile birlikte kullanılır.
Used with H 709.00

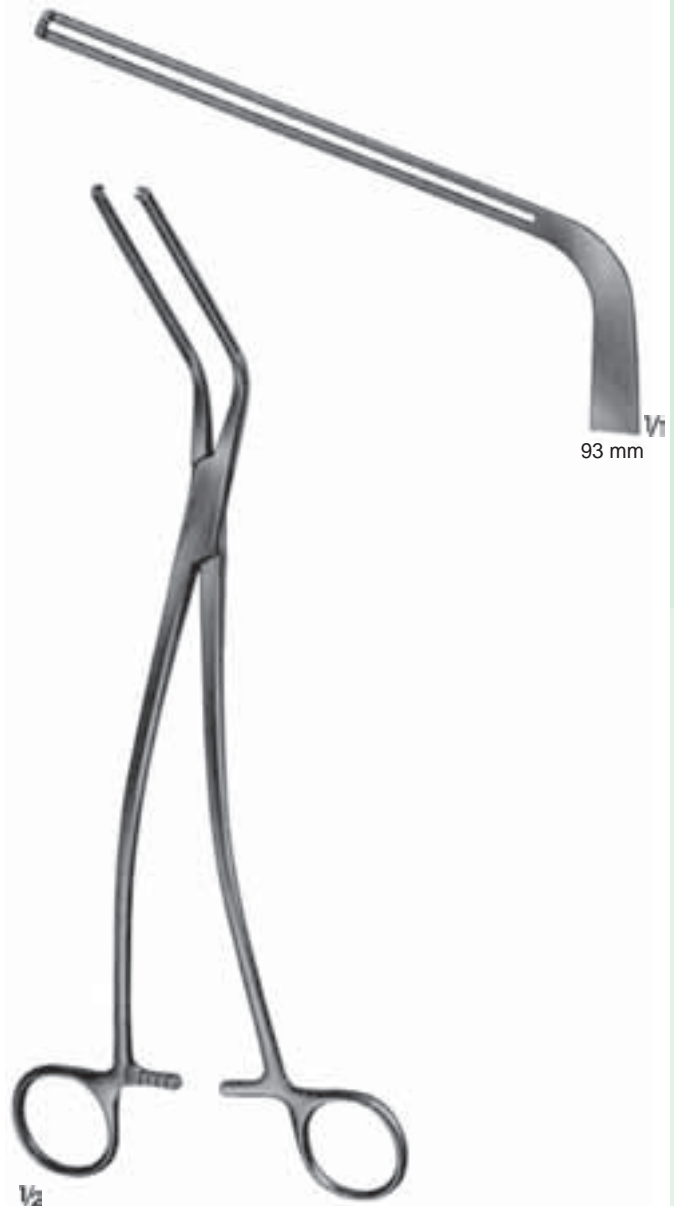

MÜLLER
H 714.00 24 cm
H 709.00 ile birlikte kullanılır.
Used with H 709.00

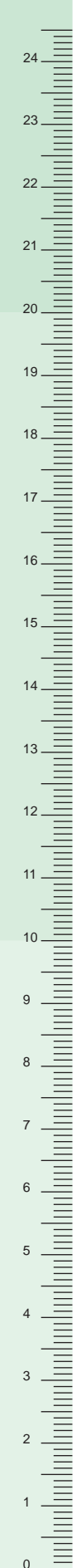



HÖPFNER
H 589.00
Damar klempl/Vessel clamp
16 cm

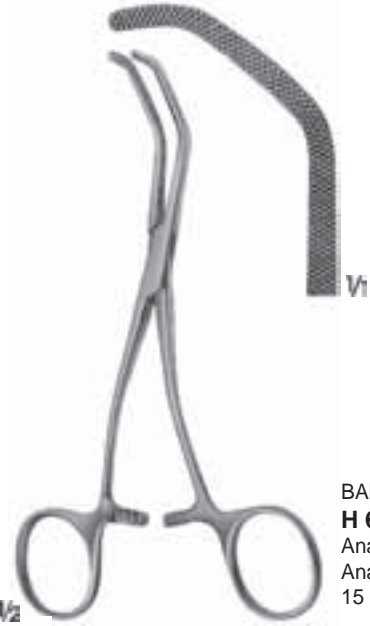

BABY-SATINSKY
H 660.00
Anastomoz klempl
Anastomosis clamp
15 cm



HARKEN
H 666.00
Vena-kava klempl/Vena-cava clamp
24 cm



H 667.00



HARKEN
H 667.00
Vena-kava klempl/Vena-cava clamp
24 cm



V1



V1



H 661.01

H 661.02



V2

HARKEN
H 665.00
Vena-kava klempli/Vena-cava clamp
24 cm



V2

SATINSKY
H 661.00
Damar klempli/Vascular clamp
26.5 cm



V2

SATINSKY
H 661.01 - H 661.02
Damar klempli/Vascular clamp
26.5 cm

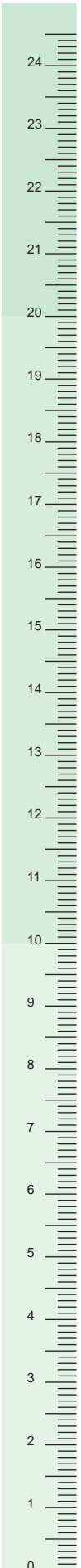



H 900.01

H 901.01



H 670.01
Esnek/Elastic

H 671.01



Esnek/Elastic



V₂

SEMB
H 900.01 - H 901.01
Diseksiyon ve dikiş pens
Dissecting and ligature forceps
24 cm



V₂

CRAFOORD
H 670.01 - H 671.01
Aort klempleri-Aorta clamps
24 cm



V₂

CRAFOORD-SELLORS
H 672.01
Aort klemp-Aorta clamp
24 cm



H 911.01

H 912.01



PRICE THOMAS
H 910.00
22.5 cm



PRICE THOMAS
H 911.01 - H 912.01
22.5 cm

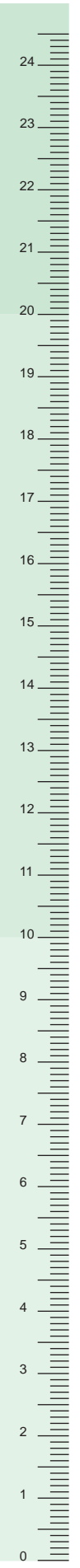

***Atromatik
Atraumatic***



H 720.00
33 cm

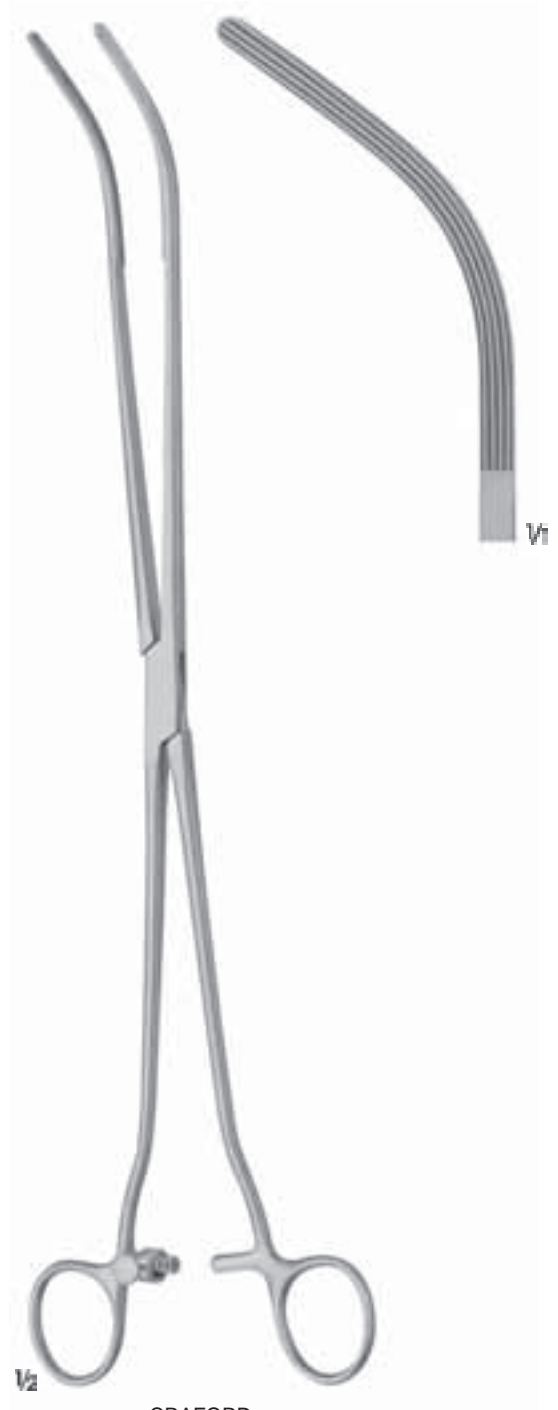

**CRAFORD
H 721.00**
36 cm



**SATINSKY
H 723.00**
37.5 cm

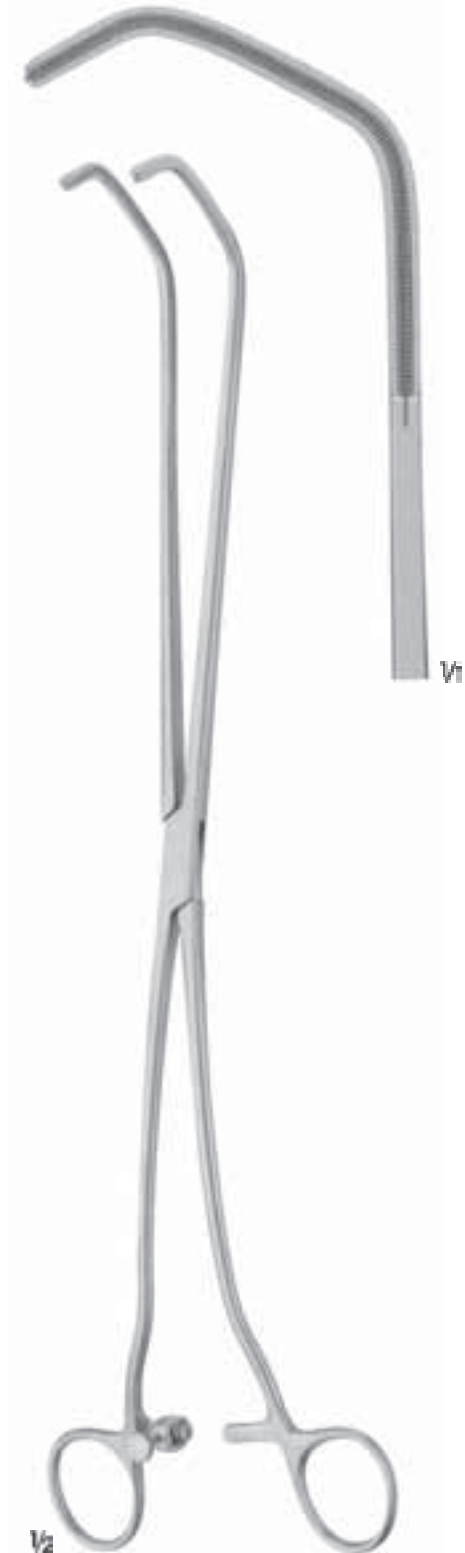

**SATINSKY
H 724.00**
37 cm

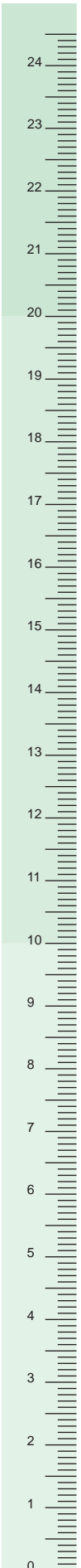

BAHADIR® Aspiratör Ucları
Suction Tubes

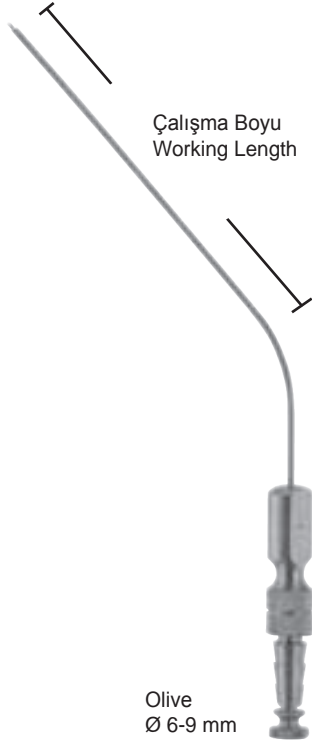

Çalışma Boyu Working Length	FERGUSSON				Ø
	11 cm	13 cm	16 cm	20 cm	
Tam boy Total Length	19.5 cm	21.5 cm	24.5 cm	28 cm	
	J 215.01	J 215.21	J 215.51	J 215.81	1.5 mm
	J 215.02	J 215.22	J 215.52	J 215.82	2.0 mm
	J 215.03	J 215.23	J 215.53	J 215.83	2.5 mm
	J 215.04	J 215.24	J 215.54	J 215.84	3.0 mm
	J 215.06	J 215.26	J 215.56	J 215.86	4.0 mm
	J 215.08	J 215.28	J 215.58	J 215.88	5.0 mm

Parmak kumandalı, Temizleme telli
parmak basma yüzeyi yatay luer bağlantı
With finger cut-of and styled
Thumb piece 90° to curve, With luer hub



FERGUSSON

J 220.02 Ø 4 mm

İzoleli, parmak kumandalı, Temizleme telli
parmak basma yüzeyi yatay luer bağlantı
Insulated, With finger cut-of and styled
Thumb piece 90° to curve, With luer hub
18 cm



FRAZIER

J 222.00 Ø 3 mm

J 222.01 Ø 5 mm

Parmak kumandalı, Temizleme telli
parmak basma yüzeyi yatay luer bağlantı
With finger cut-of and styled
Thumb piece 90° to curve, With luer hub
18 cm



PLESTER

J 212.00 Ø 1.5 mm

J 212.01 Ø 2.0 mm

J 212.02 Ø 2.5 mm

J 212.03 Ø 3.0 mm

Parmak kumandalı, Temizleme telli
parmak basma yüzeyi yatay luer bağlantı
With finger cut-of and styled
Thumb piece parallel to curve, With luer hub
19.5 cm



FINSTERER
J 600.00
32 cm

Olive
Ø 9 -13 mm

Ø 15 mm

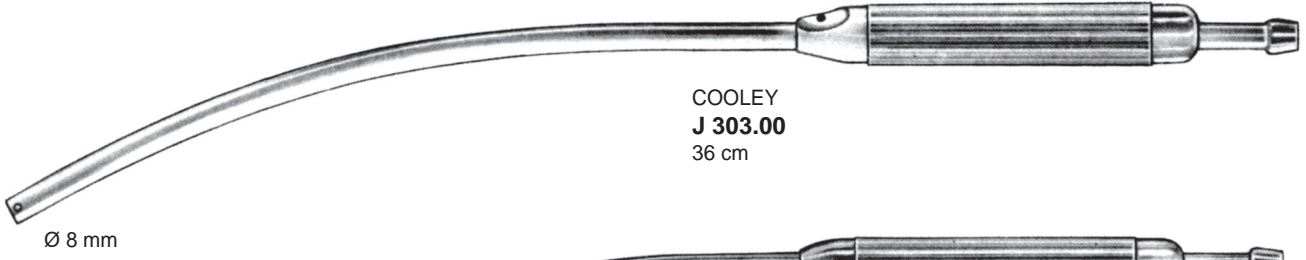

COOLEY
J 303.00
36 cm

Ø 8 mm

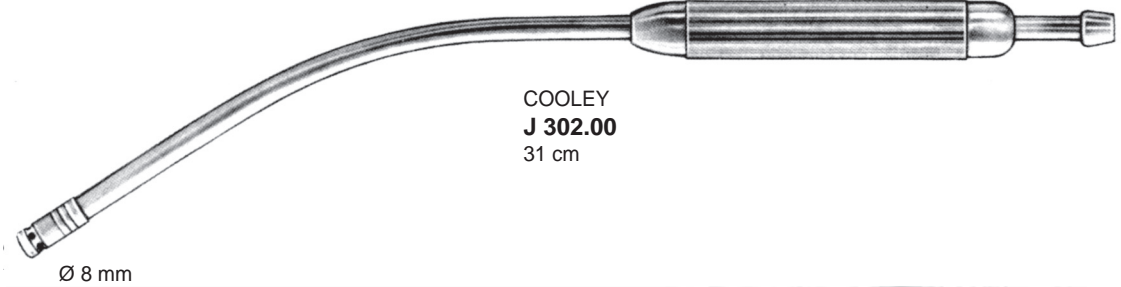

COOLEY
J 302.00
31 cm

Ø 8 mm



YANKAUER
J 301.00 Ø 2.0 mm
Merkez Delikli/With central bore
28.5 cm

Olive
Ø 7-9 mm

Ø 10 mm



DE BAKEY
J 304.00 Ø 3.0 mm
Merkezi delikli, Ø 3 mm yanar yuvalı
With central bore, Ø 3 mm with lateral slots
27.5 cm

Olive
Ø 6-10 mm

Ø 9 mm



DE BAKEY
J 306.00
Parmak kumandalı, temizleme teli
With finger cut-off and stylet
27 cm

Olive
Ø 9 mm

Ø 5 mm



HEPARIN
J 307.00 Ø 2.0 mm 2.0 cm
J 307.01 Ø 3.0 mm 4.5 cm
J 307.02 Ø 3.7 mm 5.5 cm
J 307.03 Ø 5.0 mm 16 cm



DE BAKEY
J 308.00
Parmak kumandalı, temizleme teli
With finger cut-off and stylet
16 cm

Olive
Ø 9 mm

Ø 5 mm

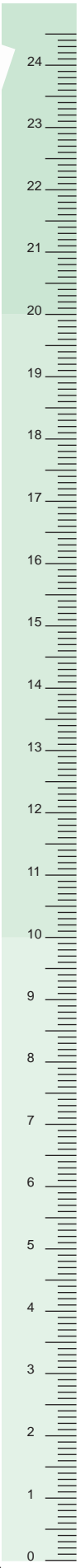

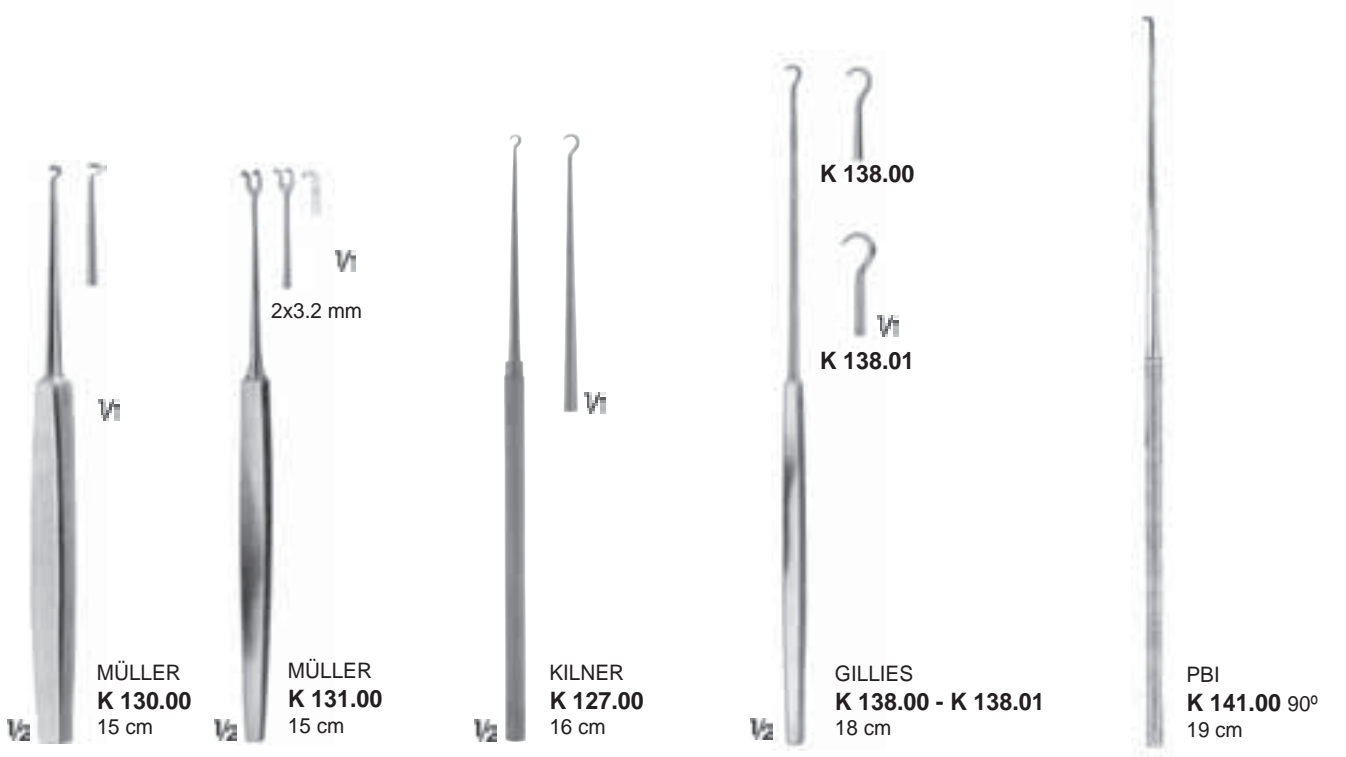



K 110.00 K 110.01 K 110.02 K 110.03

KRAYENBULH
K 110.00 - K 110.03
18.5 cm



BIEMER
T 080.00
Damar açıcı
Vessel spreader
16 cm



K 140.00
90° Eğri/Curved
18.5 cm



FISCH
K 142.00 90°
18.5 cm

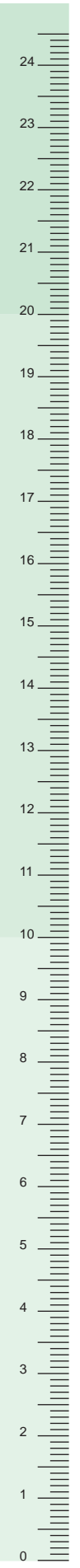

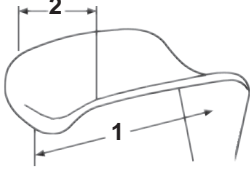
	Ekartörler bleydleri için ölçü sistemi	Measurement system for retractor blades
	Derinlik : 1	Depth: 1
	Genişlik : 2	Width: 2
	Örnek: 1 x 2 mm	Example: 1 x 2 mm

8 x 12 mm



K 152.00
17.5 cm

12 x 5 mm



K 153.00
17.5 cm

3 x 10 mm



ZENKER
K 109.00
18.5 cm



MANNERFELT
K 196.00
Eğer biçimli huk
Saddle hook, fenestrated
15.5 cm



MANNERFELT
K 190.00
15.5 cm

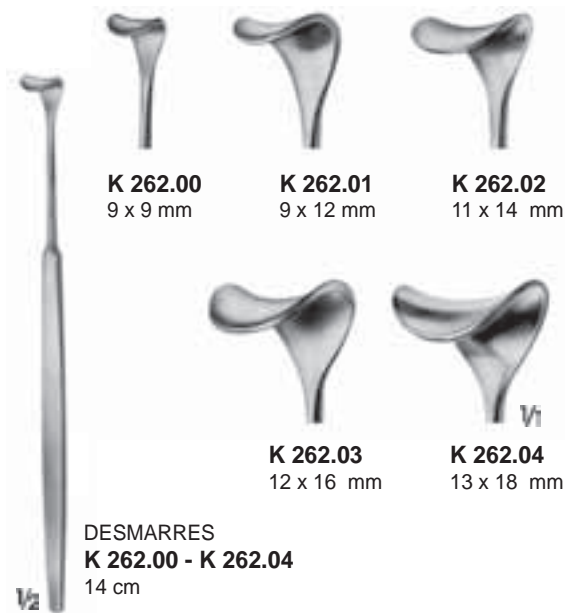

K 262.00
9 x 9 mm

K 262.01
9 x 12 mm

K 262.02
11 x 14 mm

K 262.03
12 x 16 mm

K 262.04
13 x 18 mm

DESMARRES
K 262.00 - K 262.04
14 cm

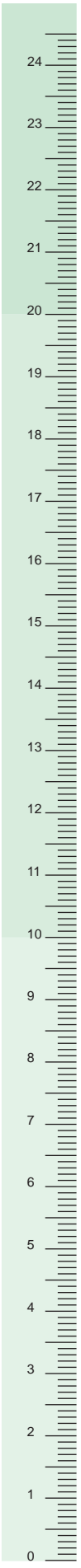
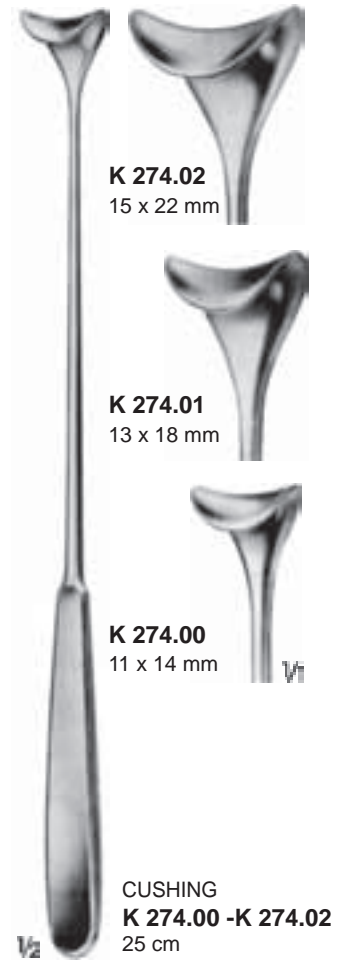
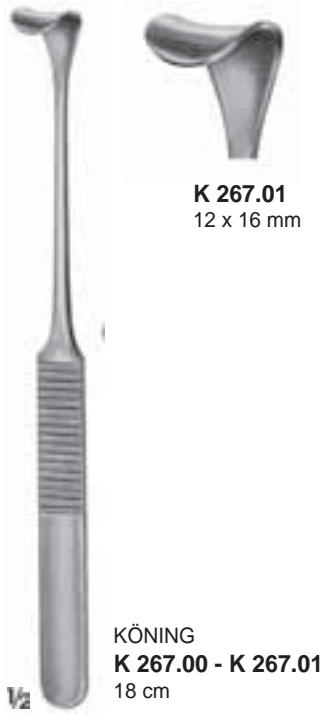



ROUX
K 325.00
Komple/Complete
16.5 cm
K 325.01 - K 325.03

19 x 22 mm



23 x 30 mm
K 325.01

25 x 26 mm



28 x 38 mm
K 325.02

28 x 29 mm



33 x 45 mm
K 325.03



1/2

VOLKMANN
K 432.02 - K 432.03
22 cm



Sivri
Sharp



K 432.02
9 x 19 mm



K 432.03
9 x 29 mm



VOLKMANN
K 430.02 9 x 19 mm
22.5 cm



Sivri
Sharp



1/2

For longitudinal
dissection of vessels

K 259.00
Küçük diseksiyon huku
Small Dissecting hook
23.5 cm



VOLKMANN
K 404.00
Sivri/Sharp
22 cm



VOLKMANN
K 405.00
Künt/Blunt
22 cm

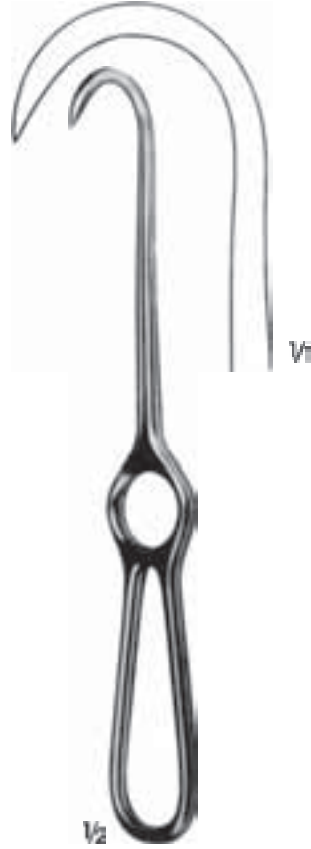

K 406.00
Sivri/Sharp
20 cm



K 408.00
Sivri/Sharp
24.5 cm

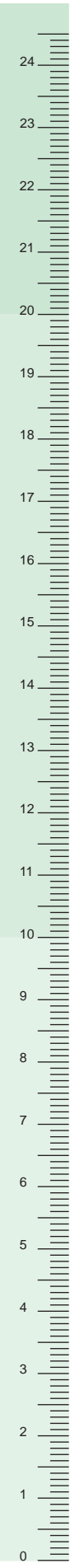

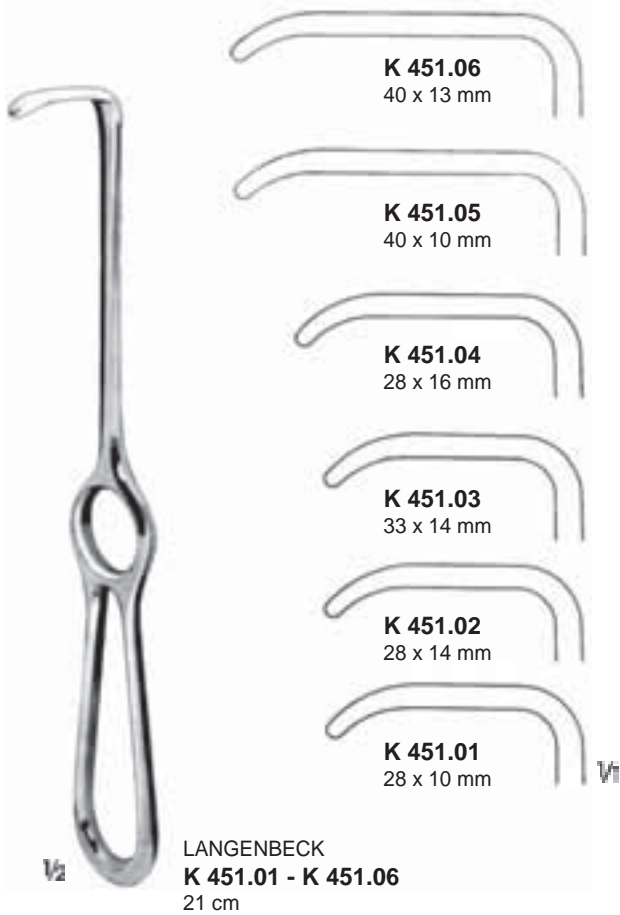



K 454.00
63 x 20 mm
21 cm

K 454.01
55 x 20 mm
22 cm



K 454.00 - K 454.01



KADER
K 676.02 30 mm
K 676.04 40 mm
27 cm



CLELAND'S
K 659.00 10 mm
25 cm

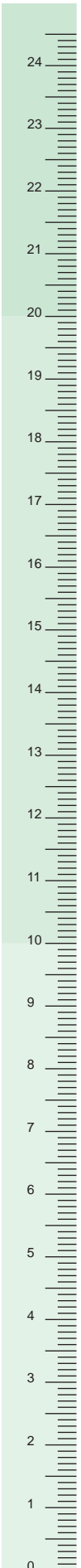



TÜBINGER
K 610.01
95 x 20 mm
26.5 cm

K 612.01
105 x 27 mm
25 cm

SIMON
K 614.01
115 x 22 mm
27.5 cm

SIMON
K 614.02
115 x 26 mm
27.5 cm

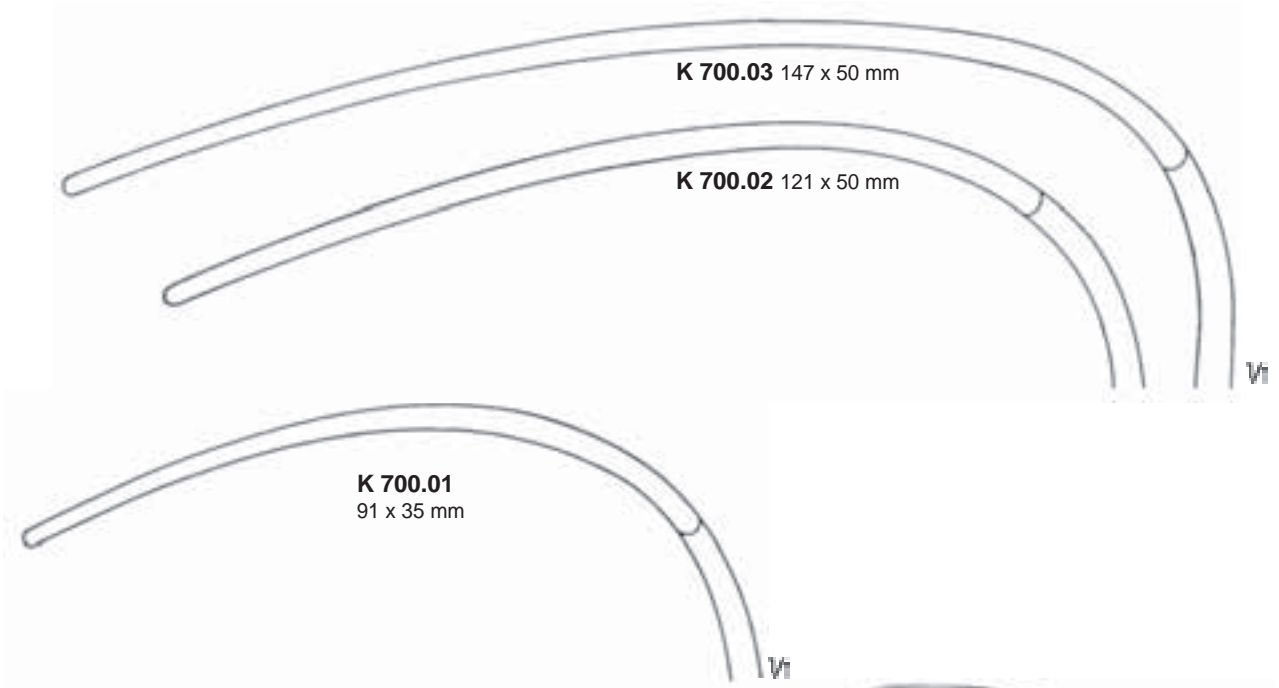

VI
MIKULICZ
K 700.01
25 cm



VI
MIKULICZ
K 700.02 - K 700.03
25 cm

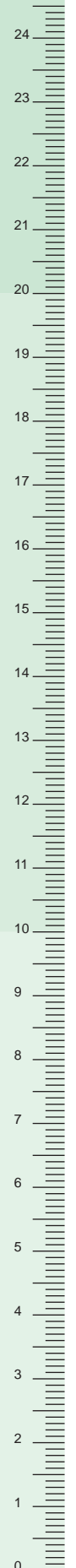







DEAYER
K 660.01
18 cm



DEAYER
K 660.02
21.5 cm



DEAYER
K 660.03
23.5 cm

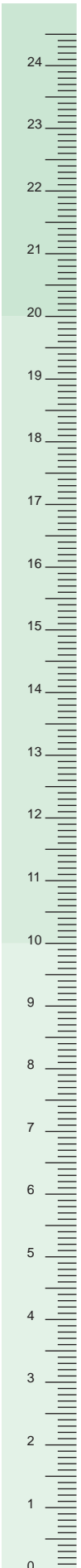



DEAYER
K 660.06
30 cm



DEAYER
K 660.07
31 cm



DEAYER
K 660.08
32 cm



DEAYER
K 660.09
36.5 cm

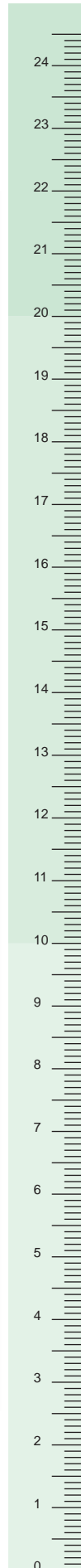



DEAVER
K 668.04
31 cm



DEAVER
K 668.05
31 cm



DEAVER
K 668.07
30.5 cm



DEAVER
K 668.08
31 cm

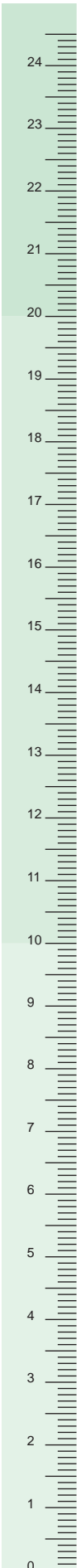



L 005.00
4.5 cm

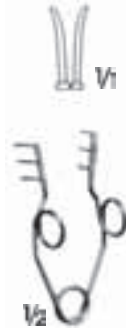

L 005.01
5.5 cm



FINSEN
L 080.00
5 cm



L 088.00 **L 088.01**
ALM
L 088.00 7 cm
L 088.01 10 cm
Künt/Blunt



BOSE
L 009.00
6 cm



ALLPORT
L 089.00 Sivri/Sharp
9.5 cm



JANSEN
L 093.00 Sivri/Sharp
10 cm



WEITLANER
L 301.00 Künt/Blunt
 11 cm



WEITLANER
L 304.00 Sivri/Sharp
 13 cm



WEITLANER
L 305.00 Künt/Blunt
 13 cm



ADSON - BABY
L 330.02 Sivri / Sharp
L 331.02 Künt / Blunt
 14 cm



WEITLANER
L 312.00 Sivri / Sharp
 16.5 cm



WEITLANER
L 313.00 Künt/ Blunt
 16.5 cm

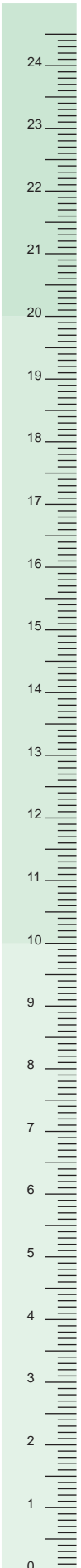

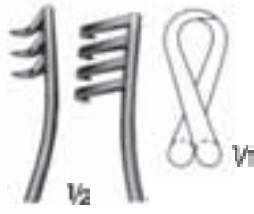

L 353.01 Sivri/Sharp
19.5 cm

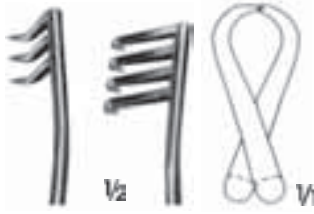

L 353.02 Sivri/Sharp
24 cm

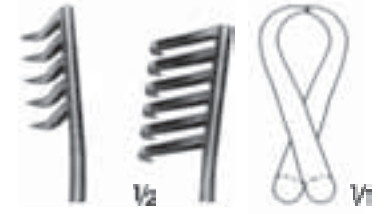

L 353.03 Sivri/Sharp
25.5 cm

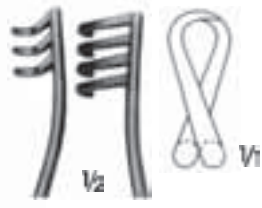

L 354.01 Künt/Blunt
19.5 cm

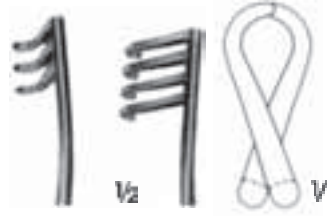

L 354.02 Künt/Blunt
24 cm



L 354.03 Künt/Blunt
25.5 cm

WEITLANER
L 353.01 - L 353.03
L 354.01 - L 354.03

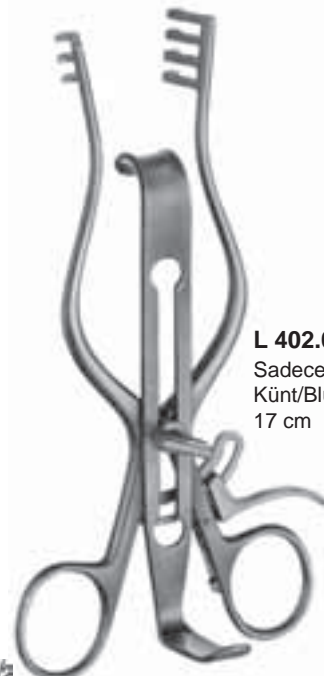

L 402.03
Sadece ekartör/Retractor only
Künt/Blunt
17 cm



L 403.03
Sadece ekartör
Retractor only



L 403.06
Künt/Blunt
60 x 50 mm



L 403.05
Yarı sivri/Semi-Sharp
40 x 35 mm

V₂

ALLENBERG

L 402.00 Komple/Complete

L 402.03 Sadece ekartör/Retractor only 17 cm

L 402.05 Bleyd/Blade 12 cm 35 x 10 mm - 20 x 12 mm

Karotis Ekartör/Carotid Retractor System

L 403.00 Komple/Complete

L 403.03 - L 403.05 - L 403.06

Poplitea Ekartör/Poplitea Retractor



ADSON
L 375.02 Yarı Sivri/Semi Sharp
32 cm



BECKMANN - EATON
L 377.02 Sivri/ Sharp
32 cm

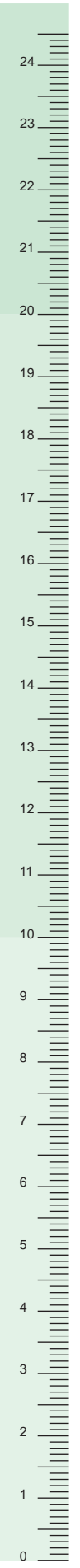

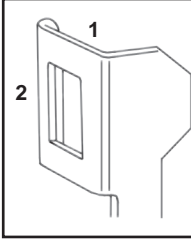
	Göğüs Ekartörü bleydleri için ölçü sistemi Derinlik : 1 Genişlik : 2 Örnek: 1 x 2	Measurement system for rib retractor blades Depth: 1 Width: 2 Example: 1 x 2
---	---	--

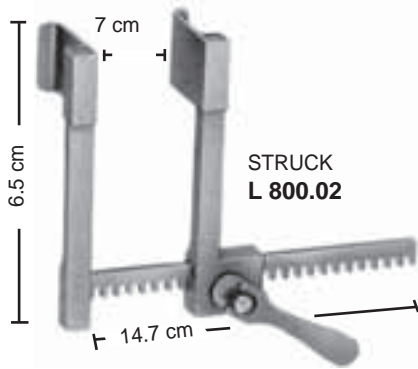

STRUCK
L 800.00 Komple/Complete
L 800.02 Sadece Ekartör/Retractor Only
L 800.05 - L 800.09 Bleyd/Blades



STRUCK
L 800.05
Bleyd/Blade
10 x 10 mm

STRUCK
L 800.06
Bleyd/Blade
10 x 15 mm

STRUCK
L 800.07
Bleyd/Blade
10 x 20 mm

STRUCK
L 800.08
Bleyd/Blade
15 x 20 mm

STRUCK
L 800.09
Bleyd/Blade
20 x 20 mm

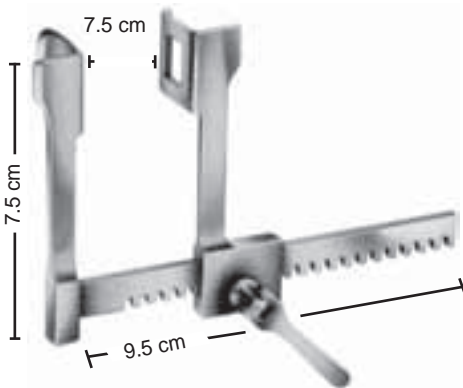

FINOCHIETTO
L 802.00
Bleyd/Blade 18 x 21 mm

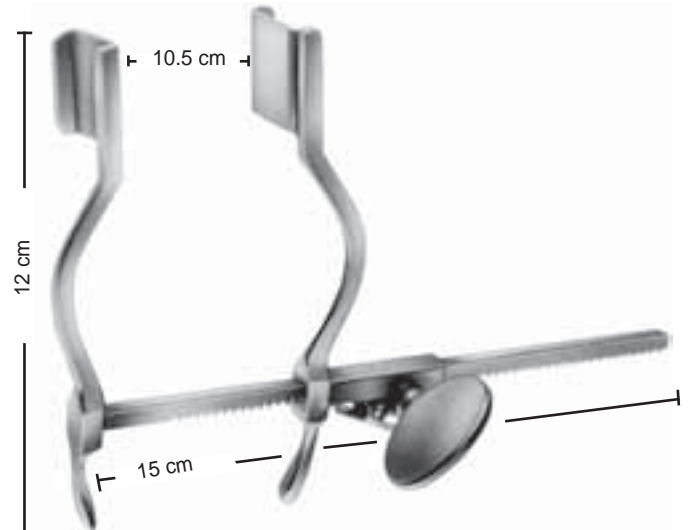

HERTZLER
L 522.00
Bleyd/Blade 20 x 25 mm

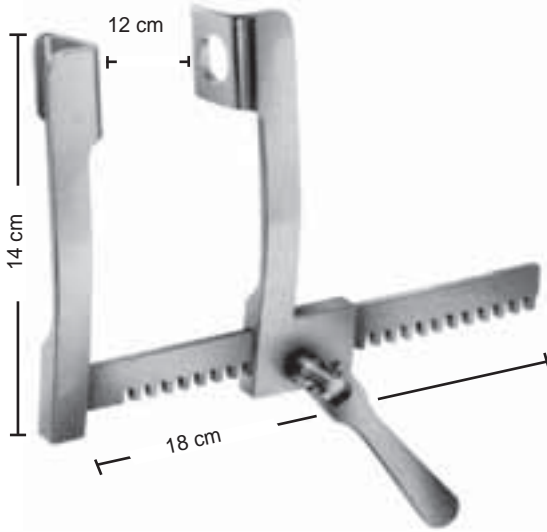

L 807.00
Göğüs Ekartörü/Rib Retractor
Bleyd/Blade 28 x 32 mm

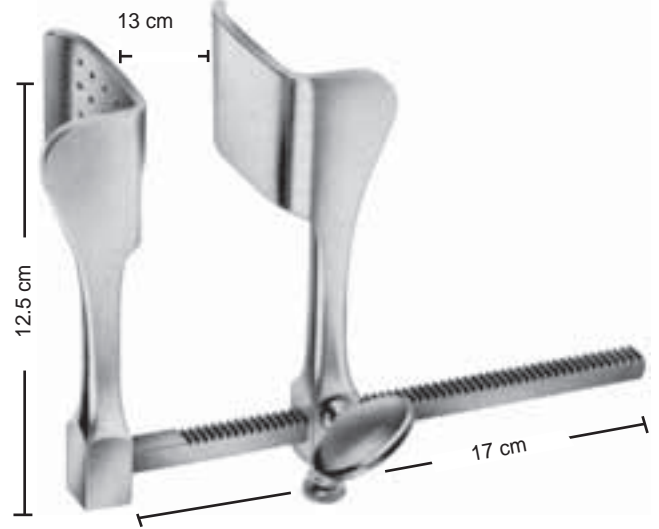

TUFFIER
L 804.00
Göğüs Ekartörü/Rib Retractor
Bleyd/Blade 43 x 53 mm

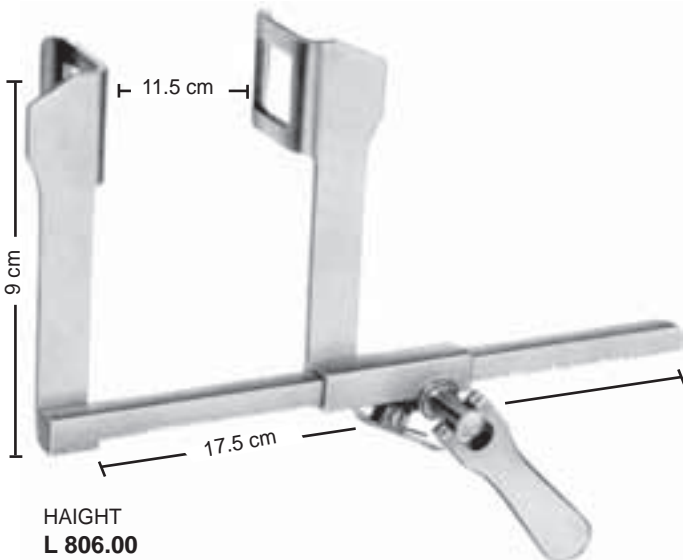

HAIGHT
L 806.00
Göğüs Ekartörü/Rib Retractor
Bleyd/Blade 30 x 30 mm

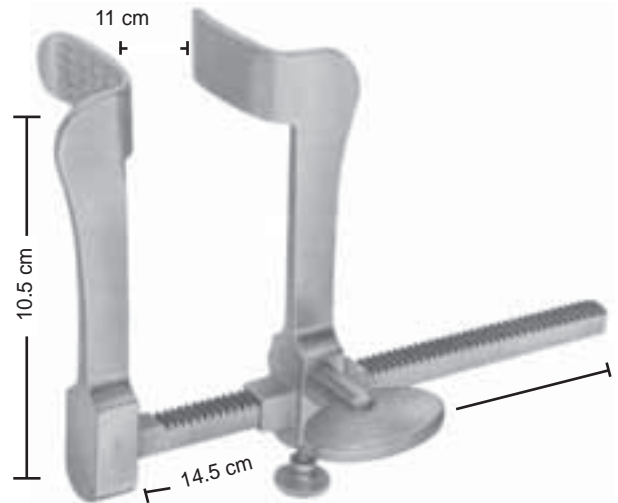

TUFFIER
L 803.00
Bebekler için Göğüs Ekartörü
Rib Retractor for infants
Bleyd/Blade 32 x 19 mm

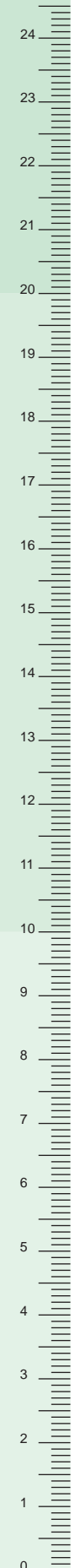

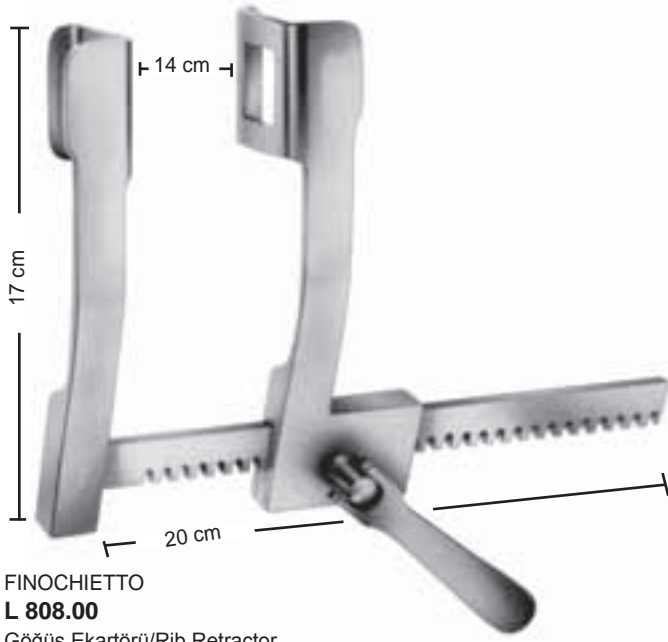

FINOCHIETTO
L 808.00

Göğüs Ekartörü/Rib Retractor
Bleyd/Blades 36 x 45 mm



ALLENBERG
L 903.01

Sadece ekartör/Retractor only



ALLENBERG
L 903.03T
Yan Bleyd/Lateral Blade
Titanyum/Titanium
30 x 30 mm



ALLENBERG
L 903.04T
Orta Bleyd/Medial Blade
Titanyum/Titanium
90 x 60 mm



ALLENBERG
D 582.00
Bleyd değiştirmek için penset
Forceps for changing the blades
13 cm

Arteria iliaca communis'e optimum yaklaşım için ekartör.

Bleydleri titanyumdan yapılmıştır ve bu sebeple x ışını geçirgendir. Büyük ekartör bleydi operasyon esnasında kademeli olarak ayarlanabilir. Ekartör bleydlerin kolaylıkla değiştirilebiliyor olması ekartör sisteminin sağ taraftan ve sol taraftan kullanımını sağlar.

Retractor system for optimal approach to the arteria iliaca communis.

The retractor blades are made out of titanium and therefore they are radiotransparent. The big medial retractor blade can be gradually adjusted during the operation. Because of the blades which are easy to exchange the retractor system can be used for the left and the right side.

Sternum ekartörü veya mamaria interna'nın operasyonuna hazırlanması için kullanılır.
Used as sternum retractor or used for preparation of the arteria mammaria interna.

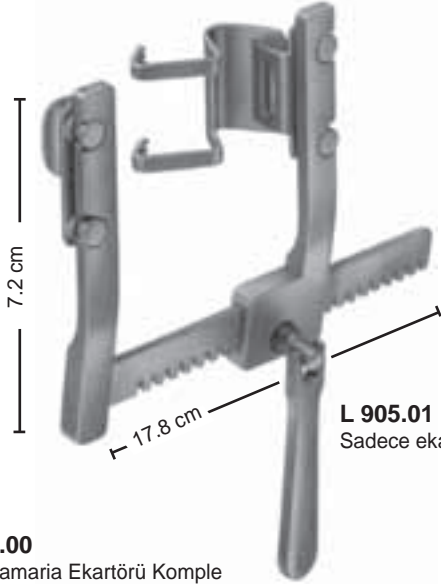

L 905.01
Sadece ekartör/Retractor only



L 905.03
Mamaria Bleyd Komple
Mammaria Blade Complete



L 905.04
1 çift sternum bleyd
1 Pair sternum blades
30 x 50 mm

- L 905.00**
Mini Mamaria Ekartörü Komple
Mini Mammaria Retractor Complete
L 905.01 Sadece ekartör/Retractor only
L 905.03 Mamaria Bleyd Komple/Mammaria Blade Complete
L 905.04 1 çift sternum bleyd/1 Pair sternum blades 30 x 50 mm

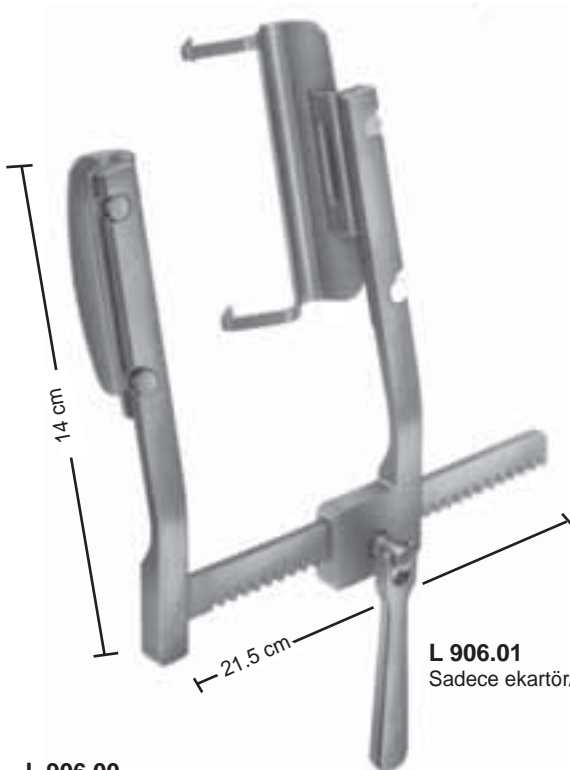

L 906.01
Sadece ekartör/Retractor only



L 906.03
Mamaria Bleyd Komple
Mammaria Blade Complete



L 906.04
1 çift sternum bleyd
1 Pair sternum blades
30 x 100 mm



L 906.05
1 çift sternum bleyd
1 Pair sternum blades
40 x 100 mm

- L 906.00**
Mamaria Ekartörü Komple
Mammaria Retractor Complete
L 906.01 Sadece ekartör/Retractor only
L 906.03 Mamaria Bleyd Komple/Mammaria Blade Complete
L 906.04 1 çift sternum bleyd/1 Pair sternum blades 30 x 100 mm
L 906.05 1 çift sternum bleyd/1 Pair sternum blades 40 x 100 mm

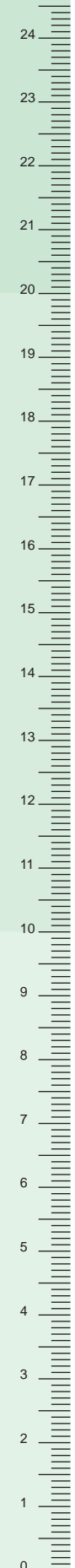

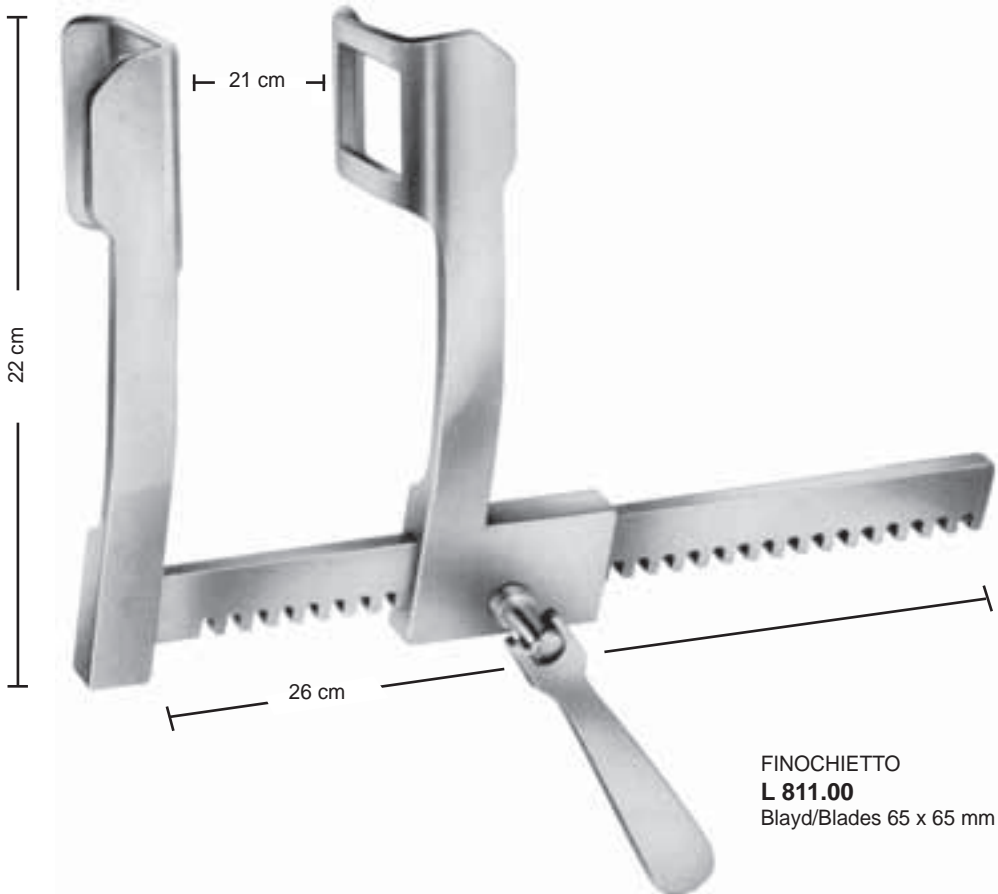
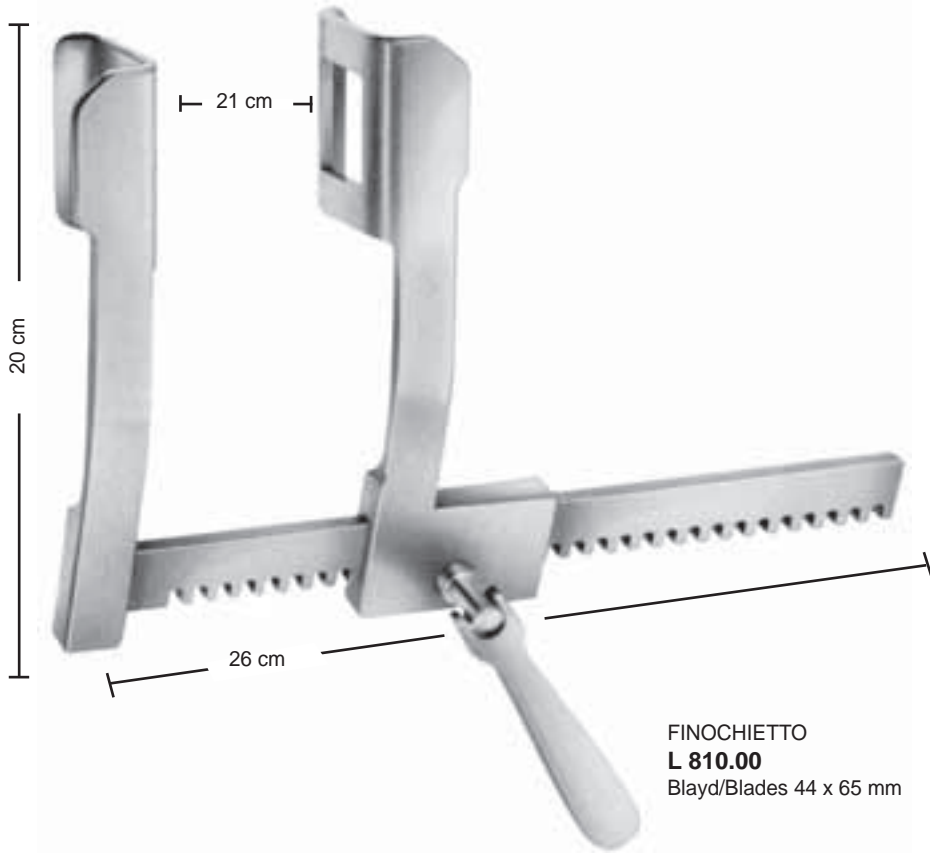

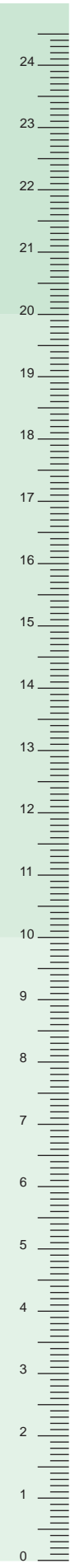
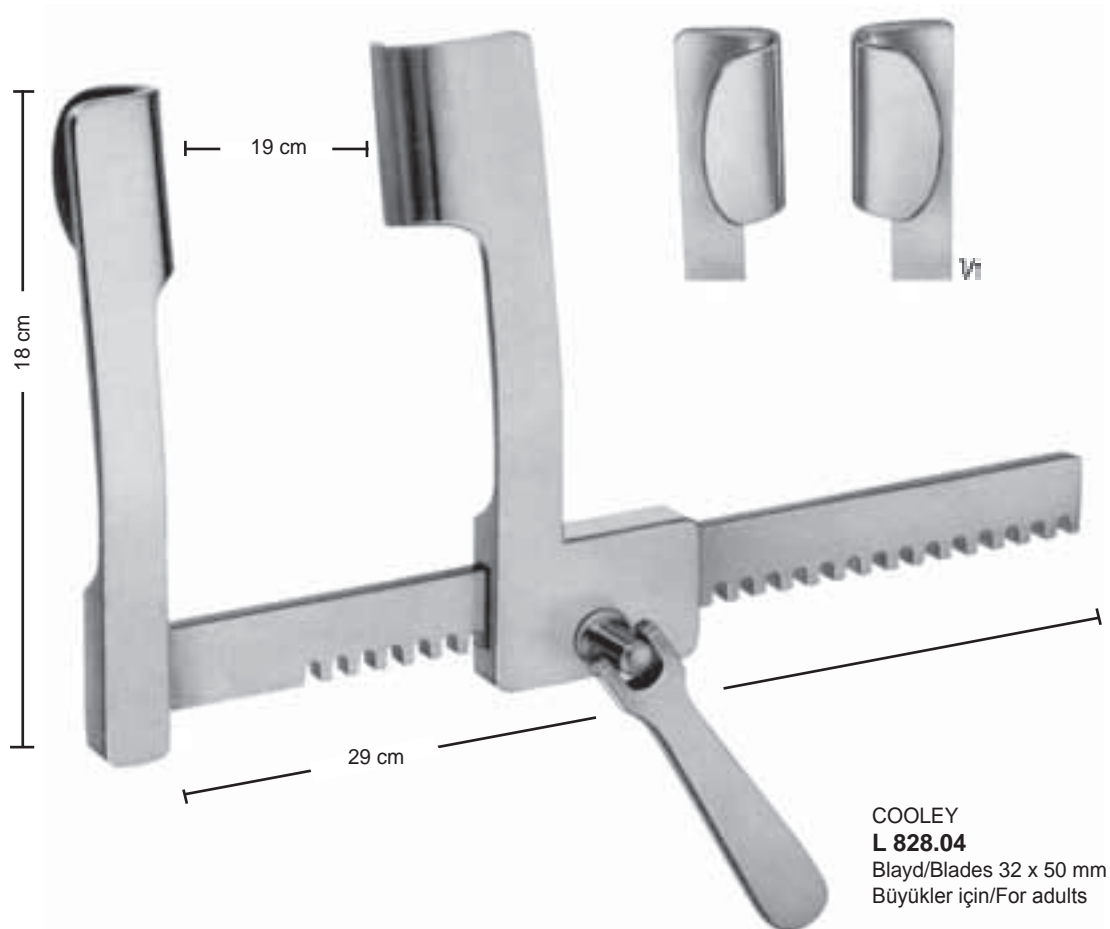
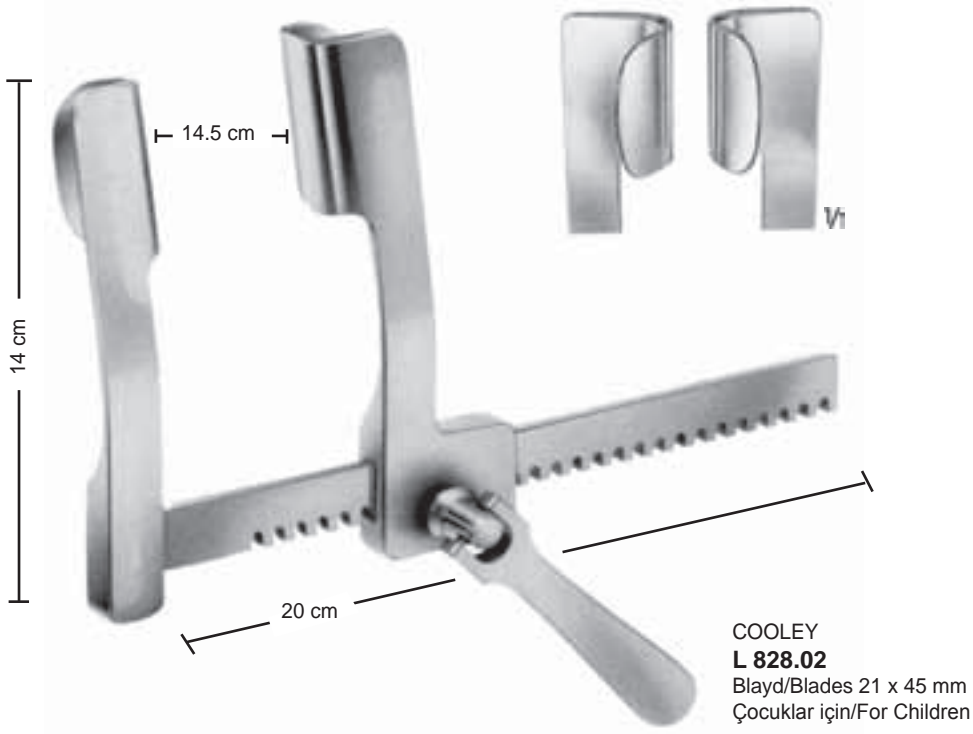

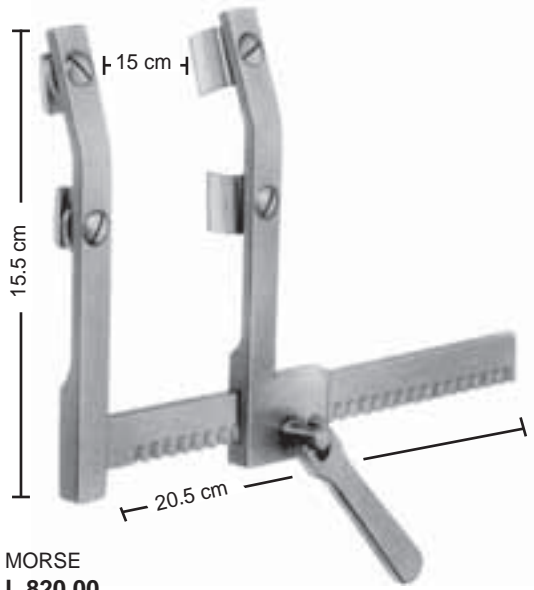

MORSE

L 820.00

Cocuklar için, hareket ettirilebilir çift bleydli
For children with movable double blades
Bleyd/Blade 12 x 20 mm

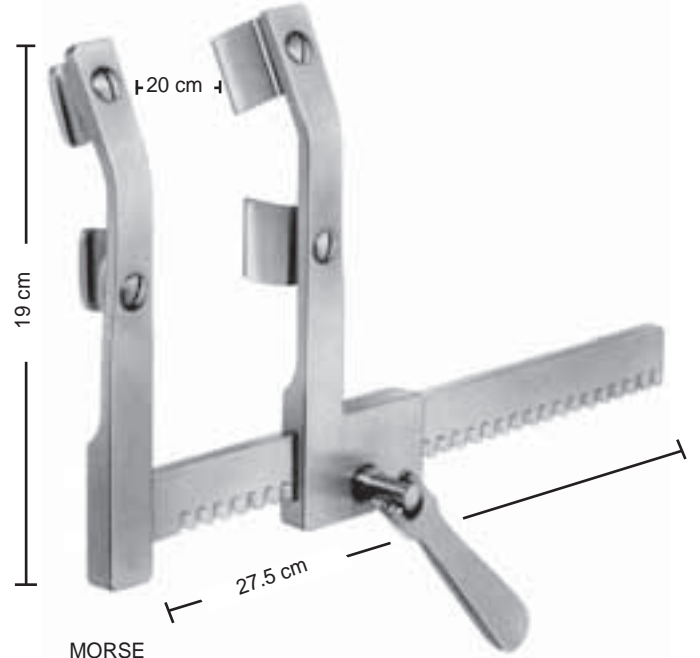

MORSE

L 820.01

Büyüklük için, hareket ettirilebilir çift bleydli
For adults, with movable double blades
Bleyd/Blade 19 x 29 mm

Special Advantages:

- Improved fixing system for interchangeable blades
- No protruding parts, therefore no risk of catching sutures

Special Advantages:

- Improved fixing system for interchangeable blades
- No protruding parts, therefore no risk of catching sutures

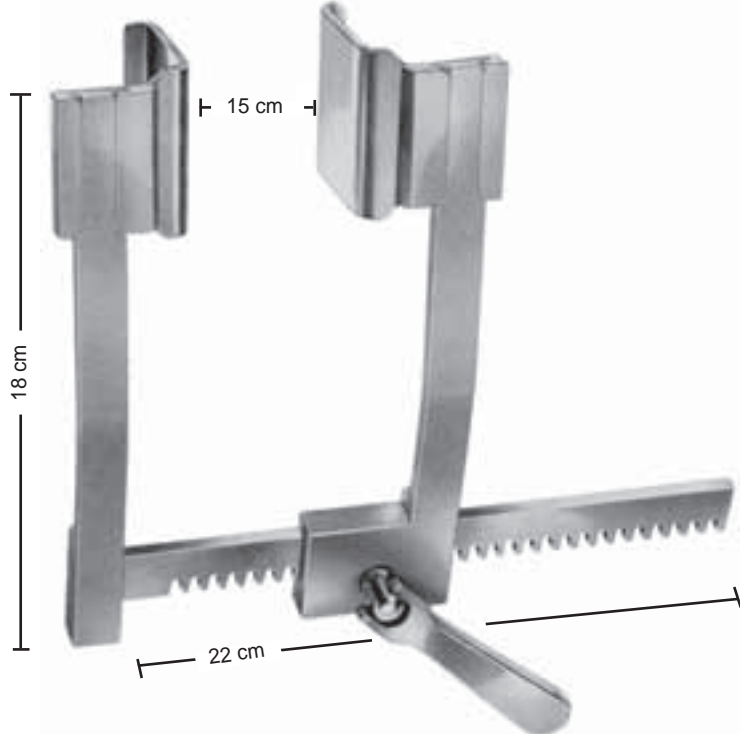

DE BAKEY

L 814.05

Bleyd/Blades
30 x 30 mm



DE BAKEY

L 814.06

Bleyd/Blades
40 x 40 mm



DE BAKEY

L 814.07

Bleyd/Blades
50 x 50 mm



DE BAKEY

L 814.00

Göğüs Ekartörü Komple
Rib Spreader Complete

L 814.01 Sadece ekartör/Retractor only

L 814.05 Bleyd(Çift)/Blades(Pair)

L 814.06 Bleyd(Çift)/Blades(Pair)

L 814.07 Bleyd(Çift)/Blades(Pair)



FINOCHIETTO-BURFORD
L 812.05
Bleyd/Blades 45 x 64 mm

FINOCHIETTO-BURFORD
L 812.10
Bleyd/Blades 75 x 64 mm

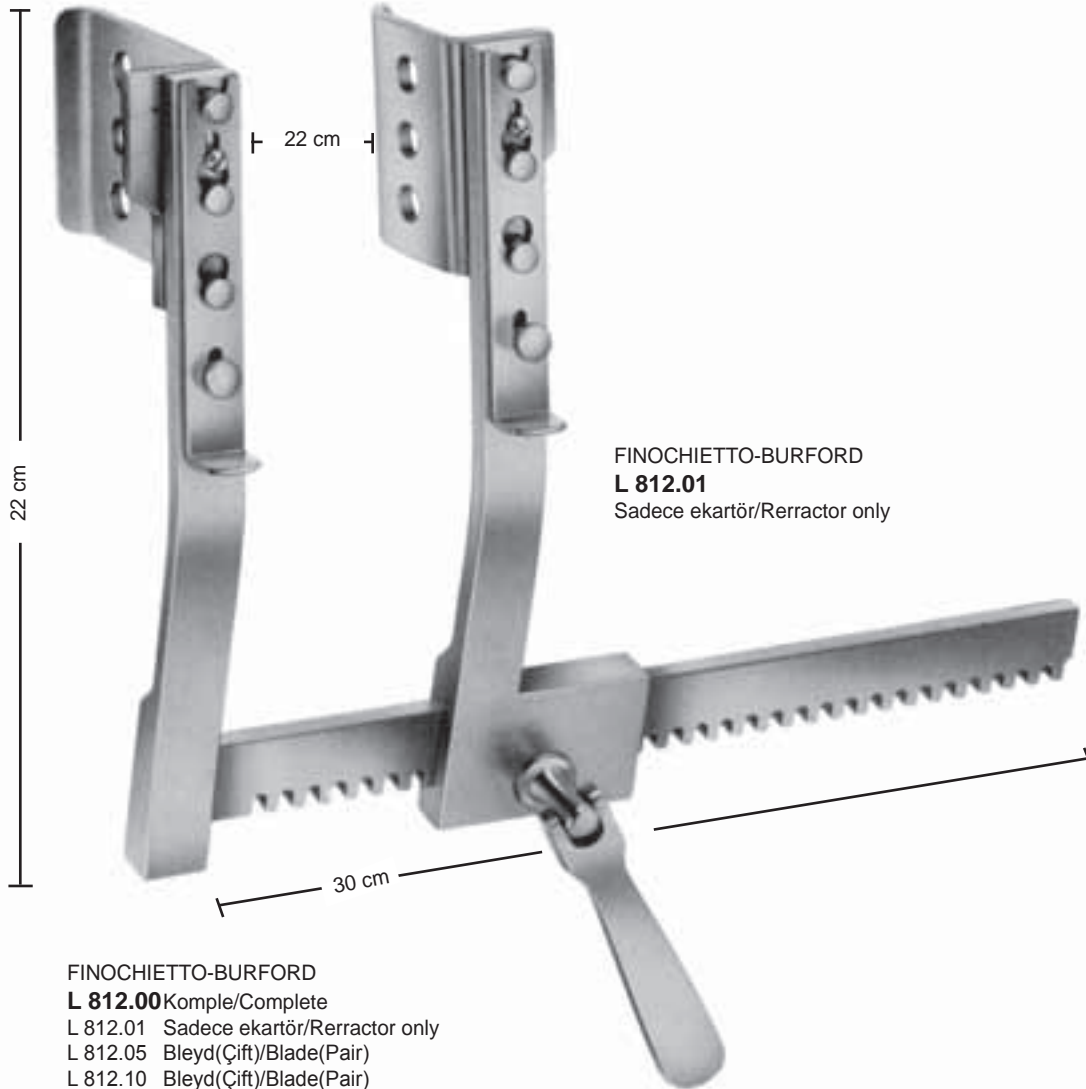

FINOCHIETTO-BURFORD
L 812.01
Sadece ekartör/Rerractor only

FINOCHIETTO-BURFORD
L 812.00 Komple/Complete
L 812.01 Sadece ekartör/Rerractor only
L 812.05 Bleyd(Çift)/Blade(Pair)
L 812.10 Bleyd(Çift)/Blade(Pair)

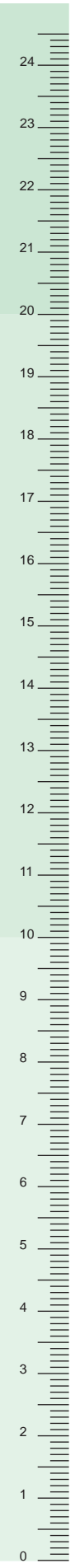

Special Advantages:

- Improved fixing system for interchangeable blades
- No protruding parts, therefore no risk of catching surures

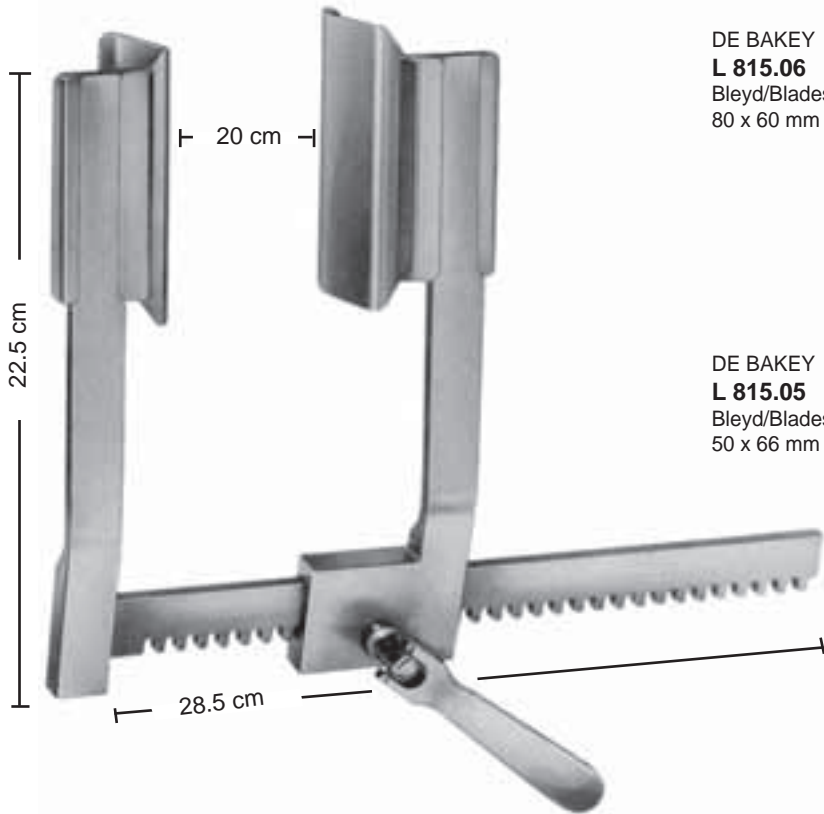

DE BAKEY
L 815.09
Bleyd/Blades
60 x 60 mm



DE BAKEY
L 815.08
Bleyd/Blades
50x 80 mm



DE BAKEY
L 815.07
Bleyd/Blades
40 x 100 mm



DE BAKEY
L 815.06
Bleyd/Blades
80 x 60 mm

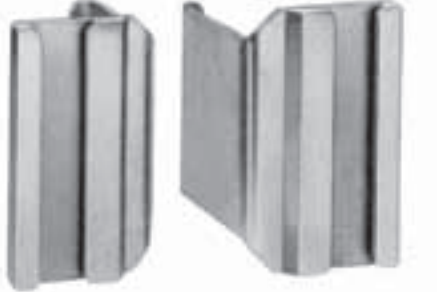

DE BAKEY
L 815.05
Bleyd/Blades
50 x 66 mm



DE BAKEY
L 815.00 Komple/Complete
L 815.01 Sadece ekartör/Rerractor only
L 815.07 Bleyd(Çift)/Blade(Pair)
L 815.08 Bleyd(Çift)/Blade(Pair)
L 815.09 Bleyd(Çift)/Blade(Pair)



L 830.06
Bleyd/Blades 75 x 75 mm

V1



L 830.01 Komple/Complete
L 830.02 Sadece ekartör/Retractor only
L 830.05 Bleyd(Çift)/Blade(Pair)
L 830.06 Bleyd(Çift)/Blade(Pair)

V2



MINI FINOCHIETTO
L 875.00A
 Bleyd/Blades 6 x 7 mm

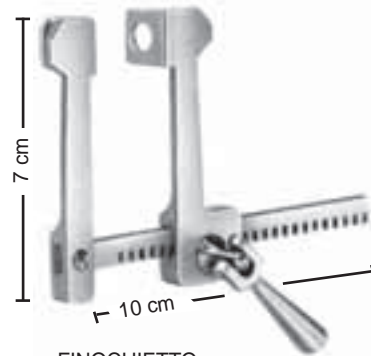

FINOCHIETTO
L 875.02A
 Bleyd/Blades 12 x 15 mm

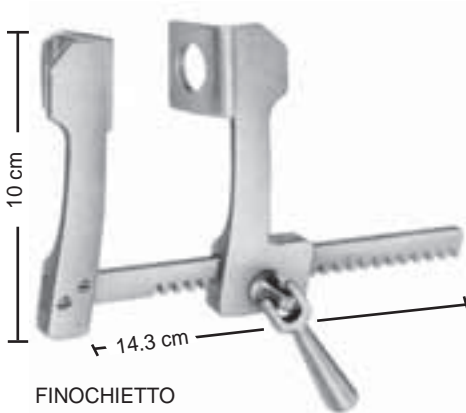

FINOCHIETTO
L 875.05A
 Bleyd/Blades 28 x 30 mm

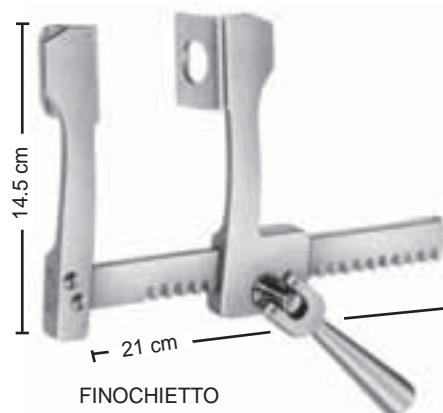

FINOCHIETTO
L 875.07A
 Bleyd/Blades 31 x 45 mm

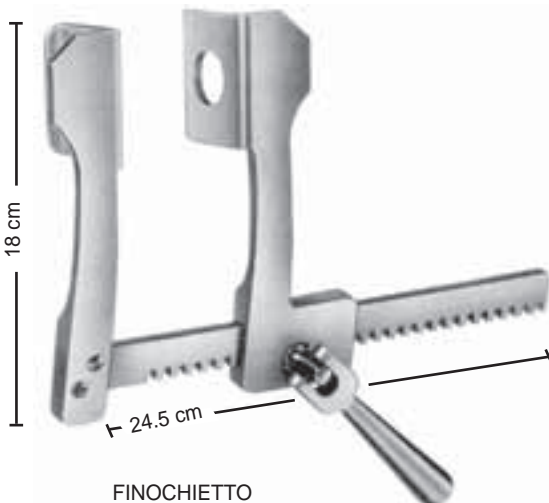

FINOCHIETTO
L 875.10A
 Bleyd/Blades 42 x 61 mm

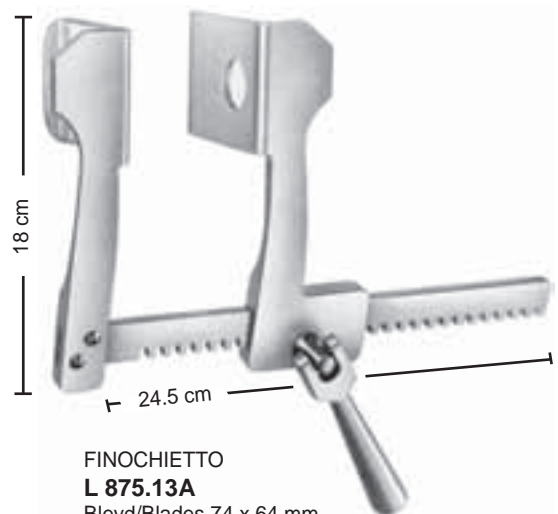

FINOCHIETTO
L 875.13A
 Bleyd/Blades 74 x 64 mm

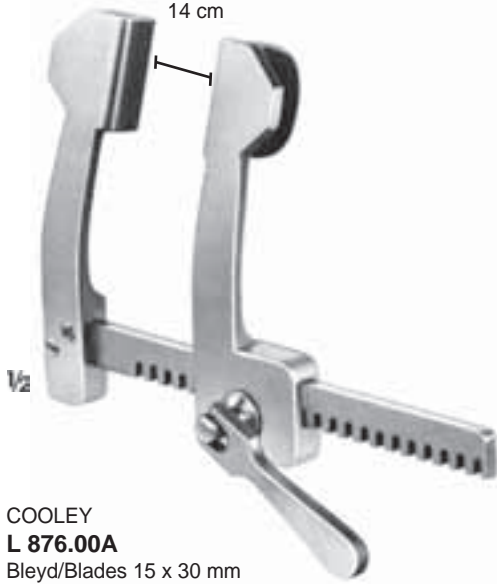

L 878.00A 13.5 cm
L 878.01A 17.5 cm
L 878.02A 17.5 cm

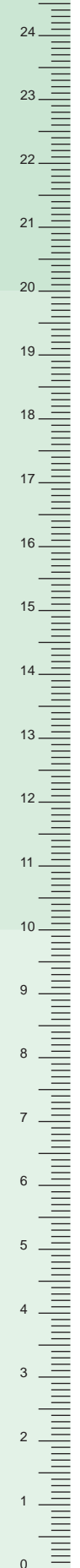
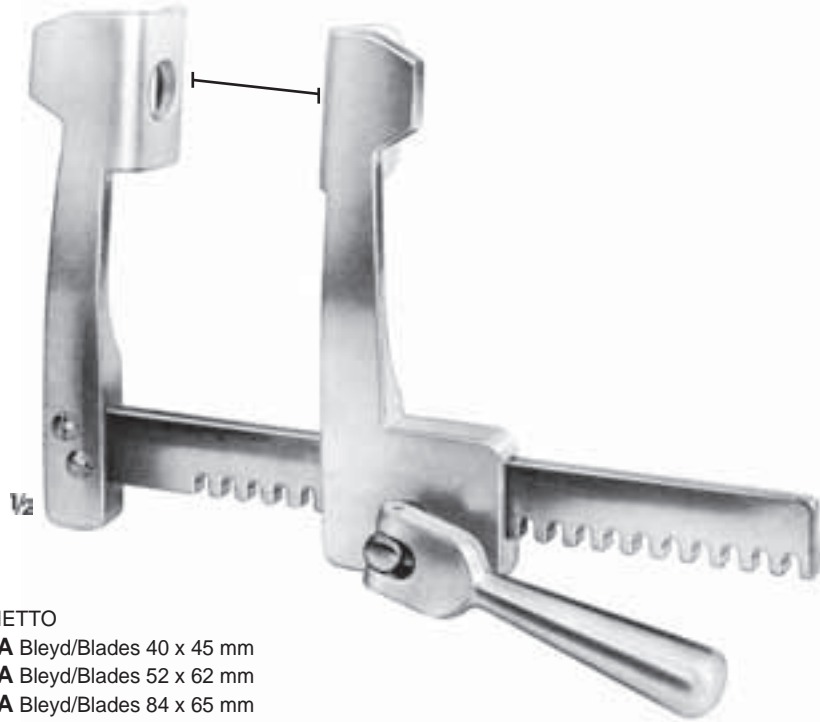

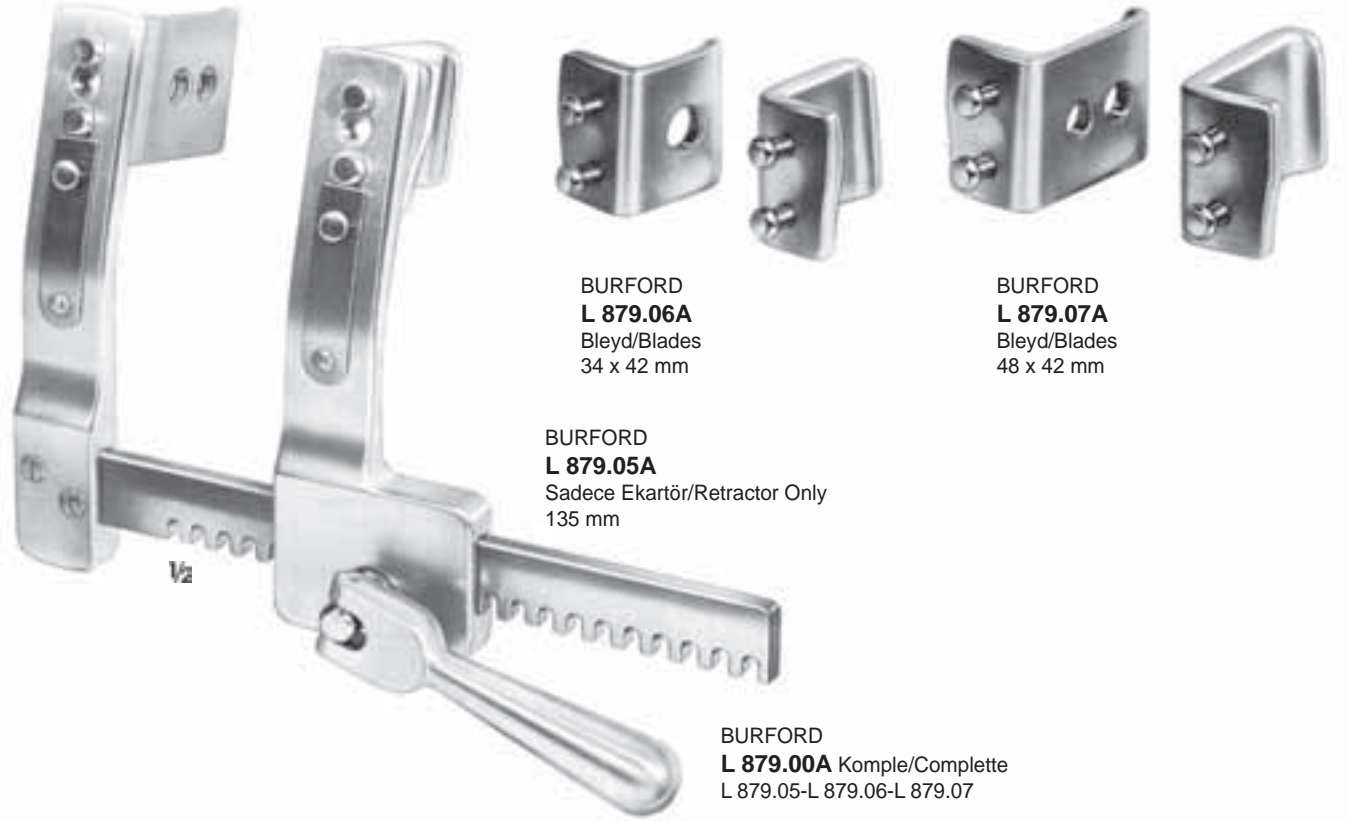

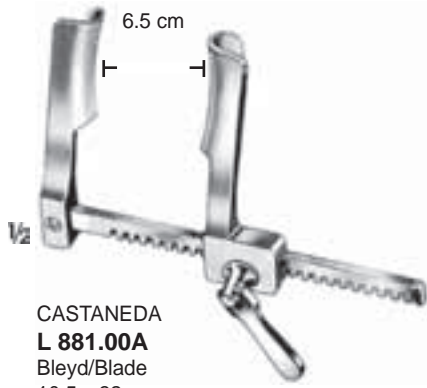

CASTANEDA
L 881.00A
Bleyd/Blade
10.5 x 32 mm

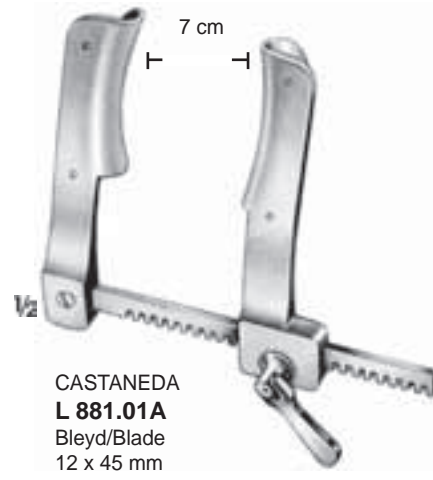

CASTANEDA
L 881.01A
Bleyd/Blade
12 x 45 mm

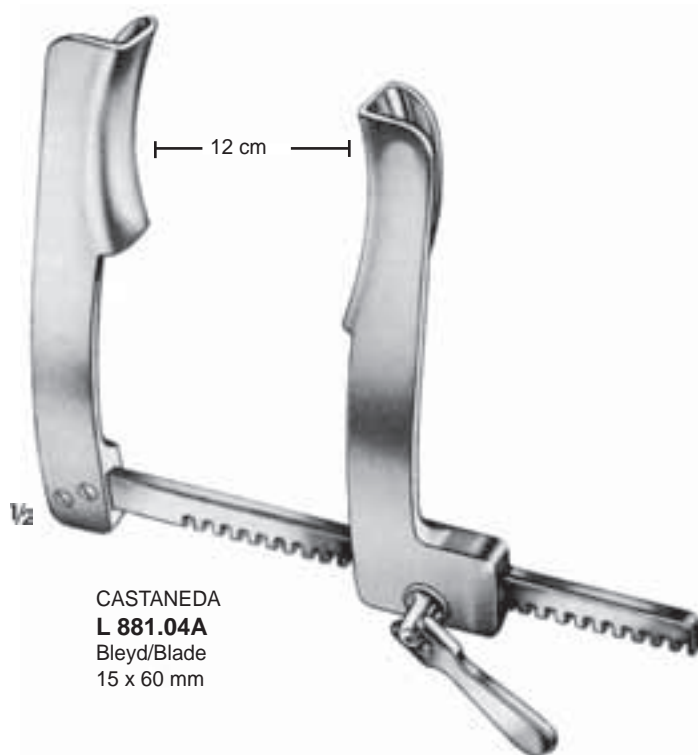

CASTANEDA
L 881.04A
Bleyd/Blade
15 x 60 mm

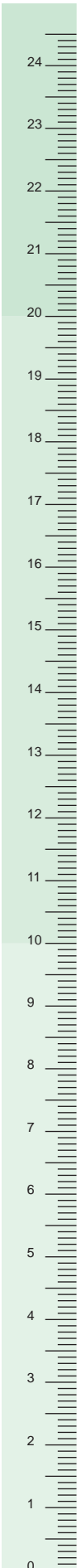

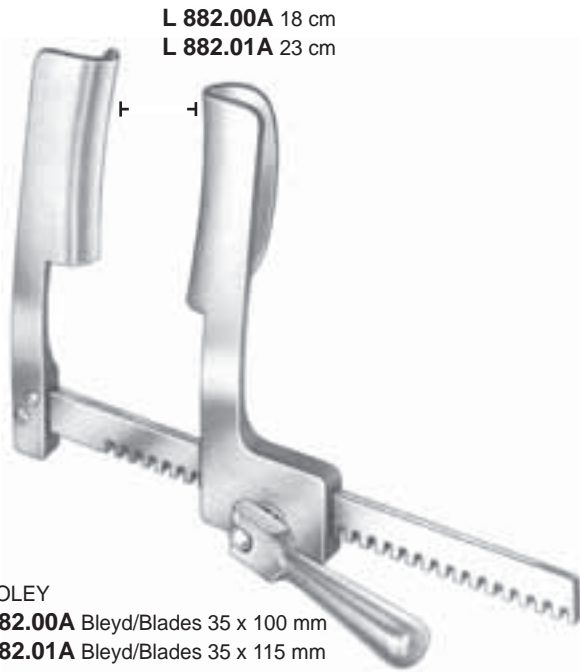

L 882.00A 18 cm
L 882.01A 23 cm

COOLEY
L 882.00A Bleyd/Blades 35 x 100 mm
L 882.01A Bleyd/Blades 35 x 115 mm

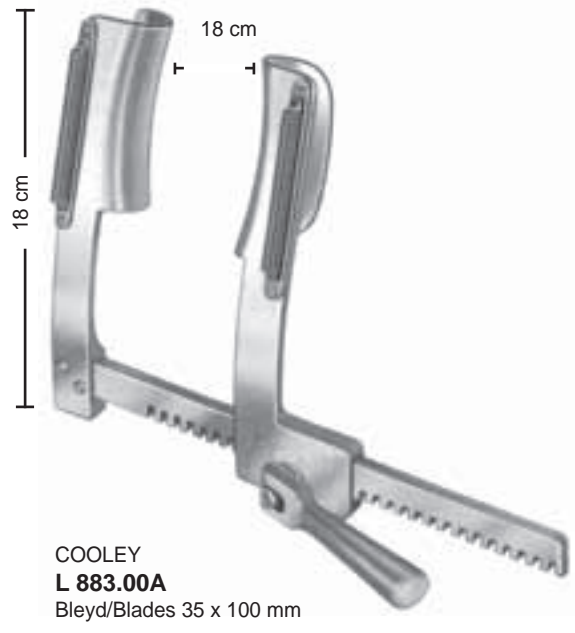

COOLEY
L 883.00A
Bleyd/Blades 35 x 100 mm

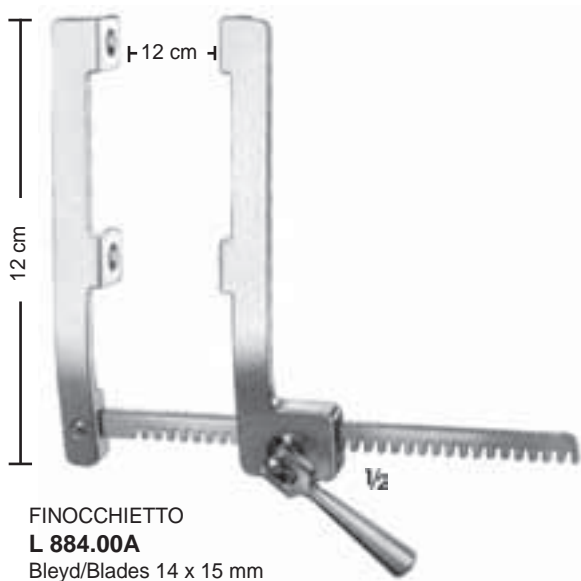

FINOCCHIETTO
L 884.00A
Bleyd/Blades 14 x 15 mm

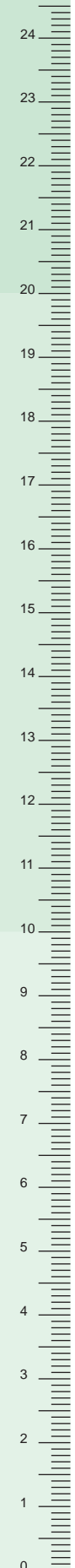
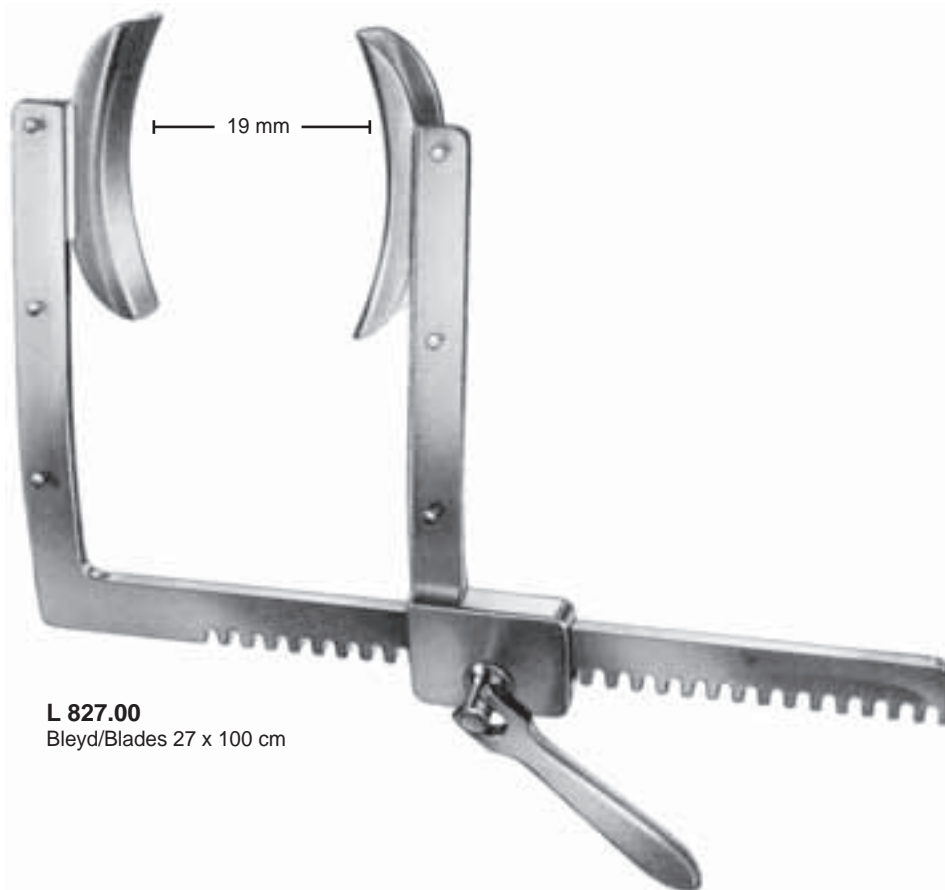
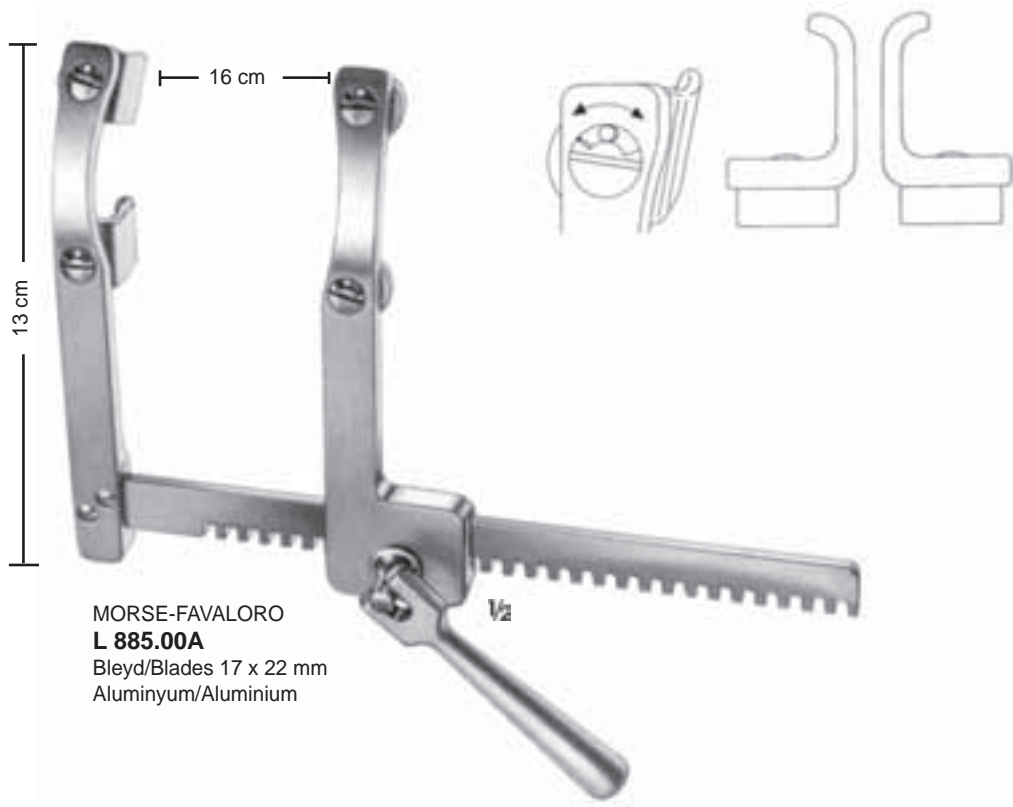

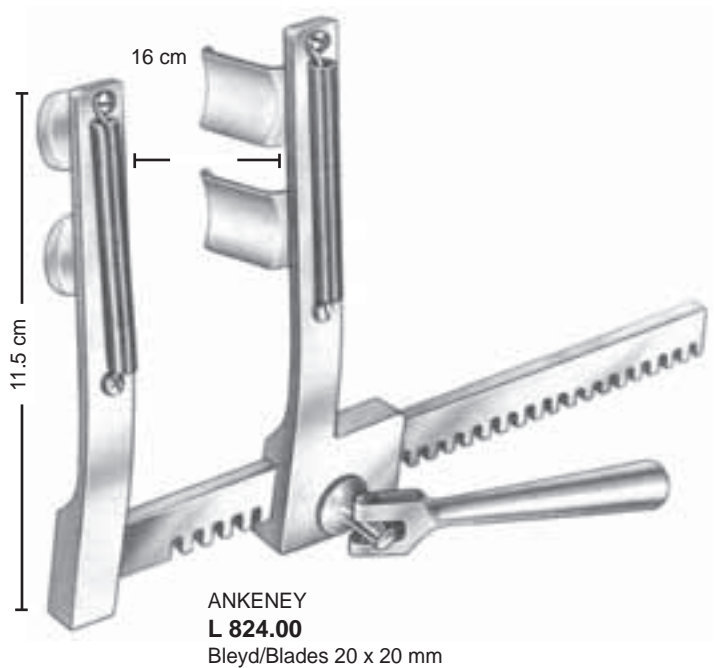
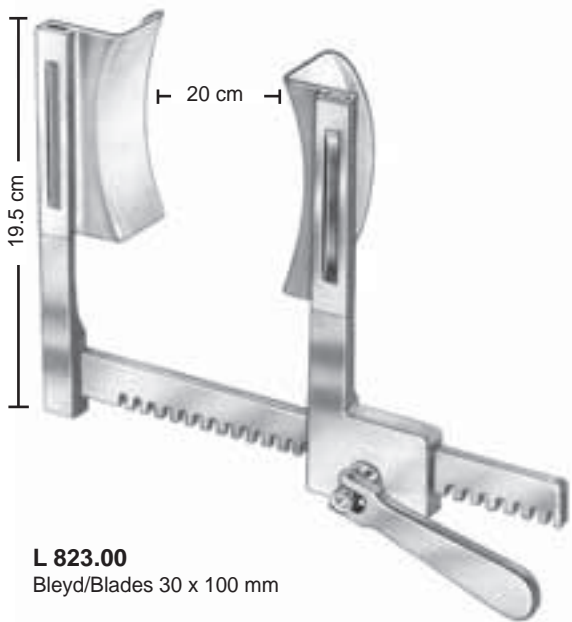
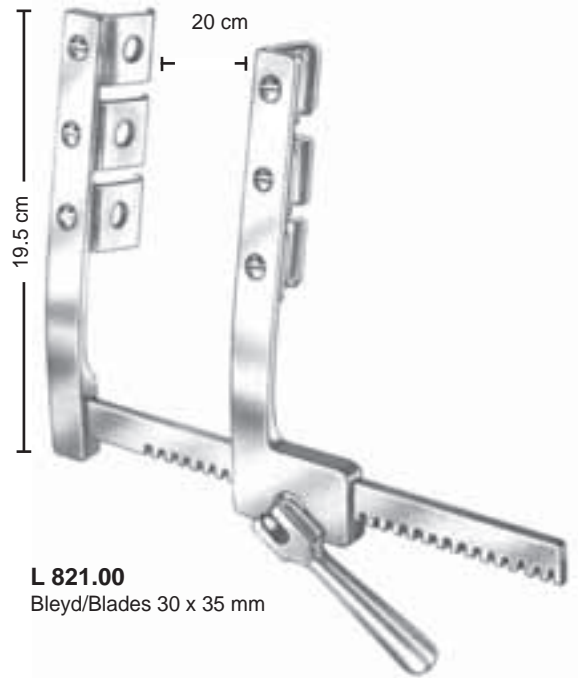
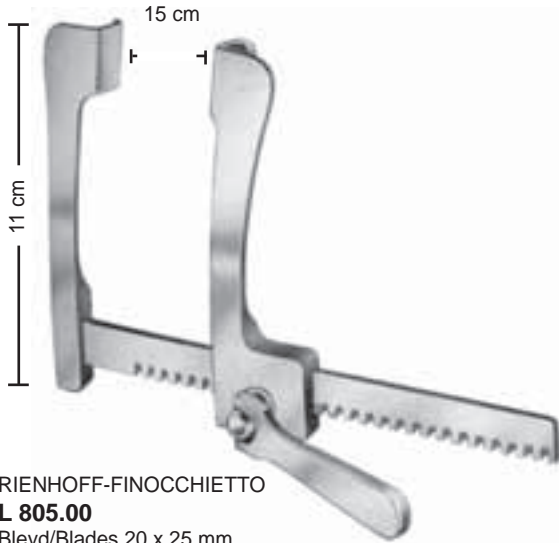

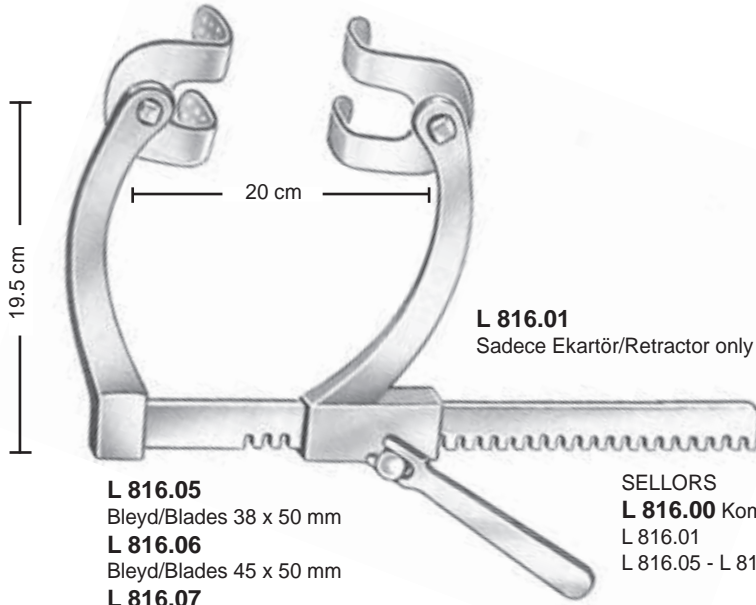

L 816.01
Sadece Ekartör/Retractor only

- L 816.05**
Bleyd/Blades 38 x 50 mm
L 816.06
Bleyd/Blades 45 x 50 mm
L 816.07
Bleyd/Blades 65 x 50 mm

SELLORS
L 816.00 Komple/Complete
L 816.01
L 816.05 - L 816.06 - L 816.07



ANKENEY
L 817.00
Bleyd/Blades 33 x 35 mm

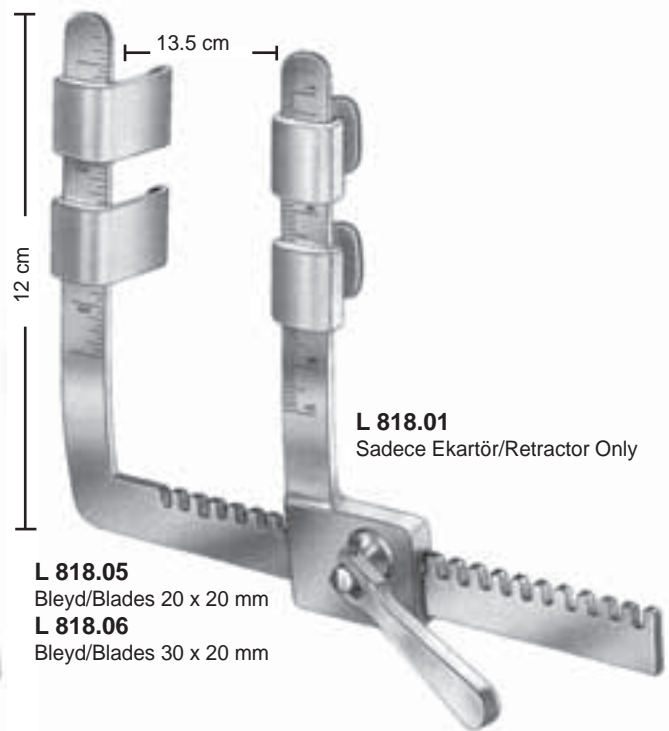

L 818.01
Sadece Ekartör/Retractor Only

- L 818.05**
Bleyd/Blades 20 x 20 mm
L 818.06
Bleyd/Blades 30 x 20 mm

SPERONI-ALEXI
L 818.00 Komple/Complete
L 818.01 - L 818.05 - L 818.06

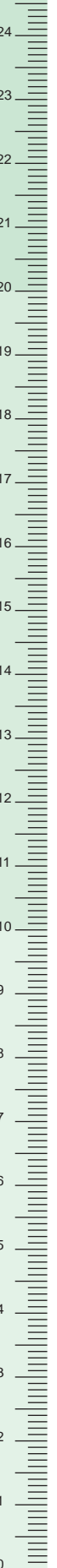

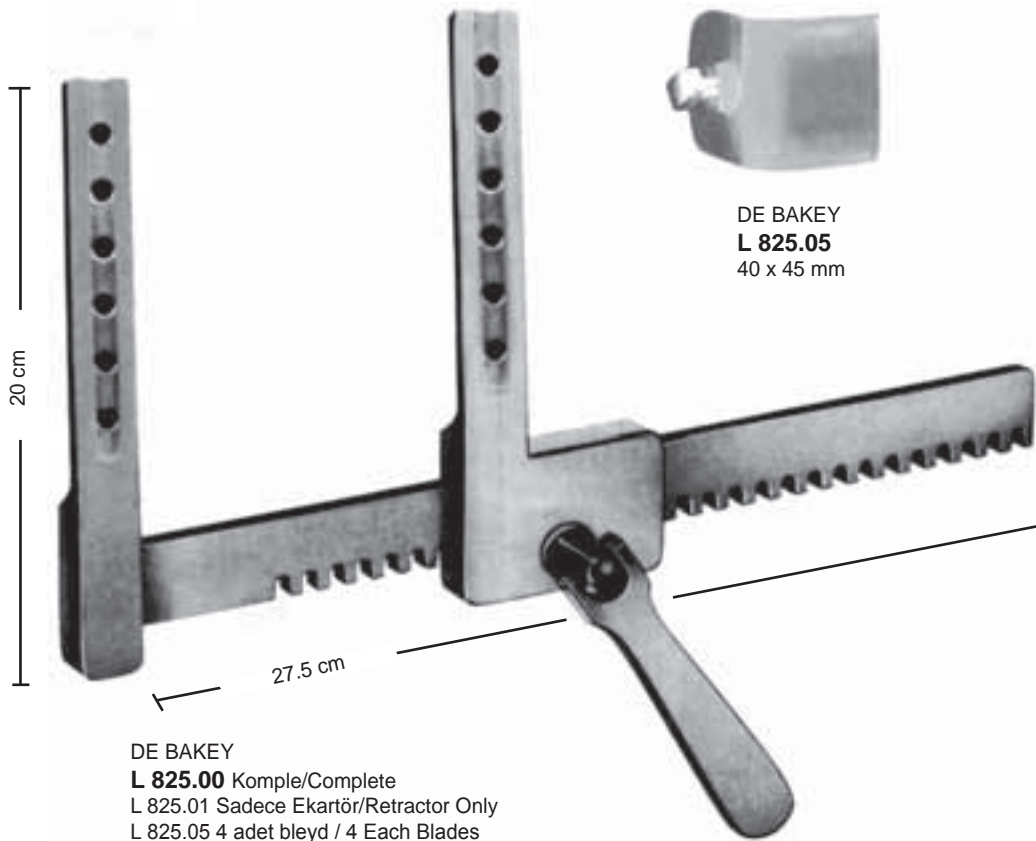
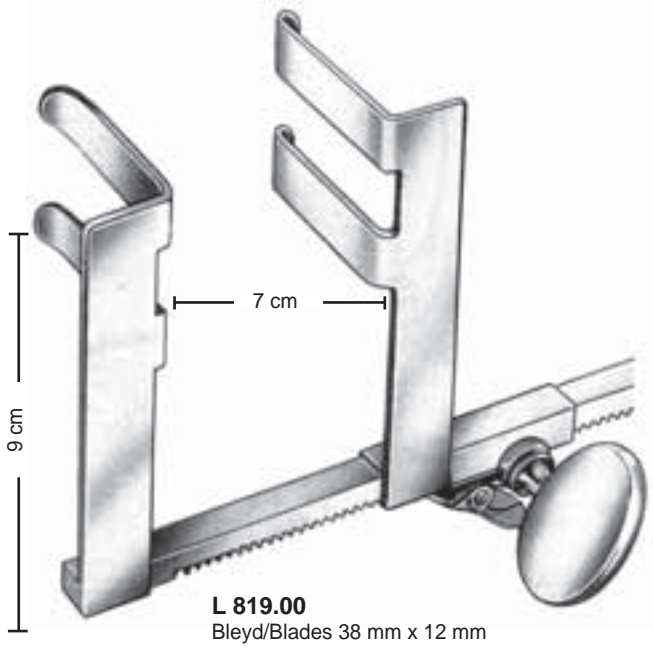

Valf Ekartör Sistemi

- Düşük operasyon platformu operasyon alanında cerrahın hareketleri için serbestlik sağlar.
- Aksesuar ve hukların sağlam tesbiti ve mükemmel uygulaması hızlı bağlantı konforu ile birleştirilmiştir.
- Taşıyıcılar kolların ve ayırıcı barların üzerine istenilen pozisyonda takılabilir veya sabitlenebilir.
- Yeni derin valf ekartör dizaynı derin göğüs kafesine sahip hastalarda çalışmak için uygundur.

Valve Retractor System

- The low operating platform provides freedom for surgeon movements in operation area.
- Strong fixation of accessories and hooks and excellent application combined with fast connection comfort.
- Carriers, can be fitted or fixed in any position on the arms and distinctive bars.
- The new deep-valve design of retractor is optimized to work on patients with deep rib cage.

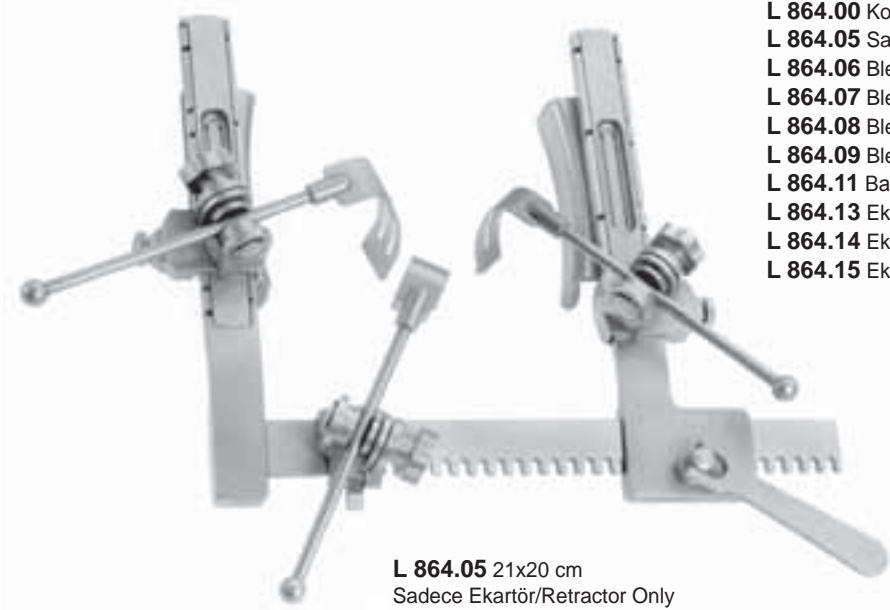

- L 864.00** Komple/Complete
- L 864.05** Sadece ekartör/Retractor only
- L 864.06** Bleyd 2 adet/Blade 2 piece
- L 864.07** Bleyd 2 adet/Blade 2 piece
- L 864.08** Bleyd 4 adet/Blade 4 piece
- L 864.09** Bleyd 4 adet/Blade 4 piece
- L 864.11** Bağlantı Klempi 3 adet/Fixation Clamp 3 piece
- L 864.13** Ekartör 2 adet/Retractor 2 piece
- L 864.14** Ekartör 2 adet/Retractor 2 piece
- L 864.15** Ekartör 2 adet/Retractor 2 piece

L 864.05 21x20 cm
Sadece Ekartör/Retractor Only



L 864.11



L 864.08 30x28 mm
L 864.09 40x28 mm



L 864.06 30x100 mm
L 864.07 40x100 mm



L 864.13 18x52 mm
Küçük/Small
L 864.14 18x80 mm
Orta/Medium
L 864.15 22x80 mm
Büyük/Large

Minimal Invaziv Valf Cerrahi
Minimally Invasive Valve Surgery



L 860.07
30 x 60 mm

L 860.05
Sadece Ekartör/Retractor Only

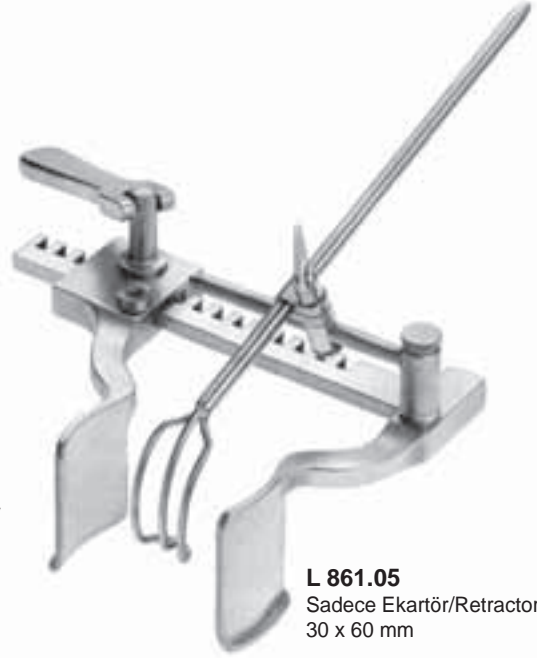

L 861.05
Sadece Ekartör/Retractor Only
30 x 60 mm

L 860.00 Komple/Complete

L 860.05 Sadece Ekartör/Retractor Only 1 adet/1 piece 30 x 60 mm

L 860.06 Extra Dönen Sürgü/Extra Turnable Crossbar 1 adet/1 piece

L 860.07 Bleyd 2 Adet/Blade 2 piece

L 834.00 Spatula 1 adet/Spatula 1 piece

L 839.00 Atrial Ekartör 1 adet/Atrial Retractor 1 piece

L 840.00 Atrial Ekartör 1 adet/Atrial Retractor 1 piece

L 849.01 Bağlantı Klempi 1 adet/Fixation Clamp 1 piece

L 861.00 Komple/Complete

L 861.05 Sadece Ekartör/Retractor Only 30 x 60 mm

L 860.06 Ekstra dönen sürgü/Extra turnable crossbar

L 834.00 Spatula 1 adet/Spatula 1 piece

L 839.00 Atrial Ekartör 1 adet/Atrial Retractor 1 piece

L 840.00 Atrial Ekartör 1 adet/Atrial Retractor 1 piece

L 849.01 1 adet Bağlantı Klempi/Fixation Clamp 1 piece

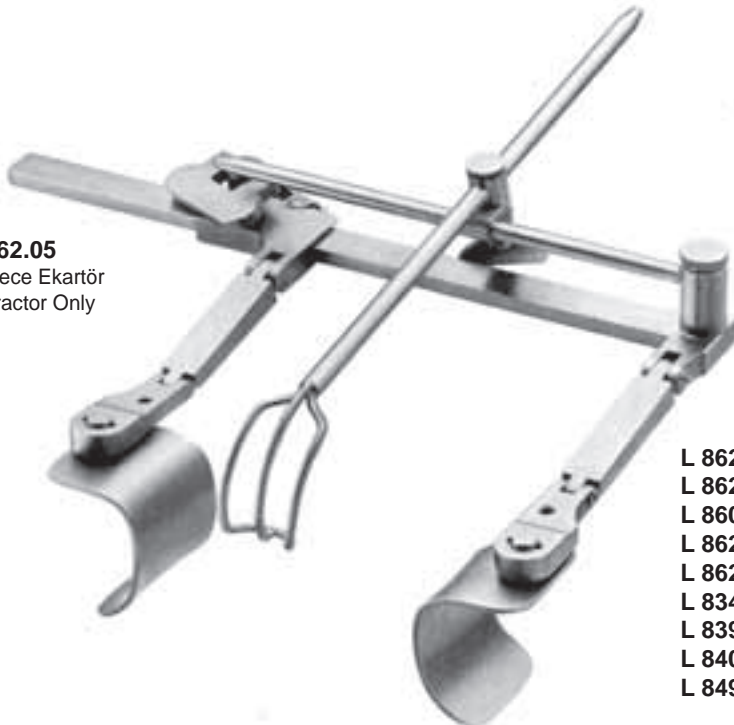

L 862.05
Sadece Ekartör
Retractor Only

L 862.00 Komple/Complete

L 862.05 Sadece Ekartör/Retractor Only

L 860.06 Extra dönen sürgü/Extra turnable crossbar

L 862.07 Bleyd 30x40 mm 2 Adet/Blade 30x40 mm 2 Peace

L 862.08 Bleyd 30x60 mm 2 Adet /Blade 30x60 mm 2 Peace

L 834.00 Spatula 1 adet /Spatula 1 piece

L 839.00 Atrial Ekartör 1 adet/Atrial Retractor 1 piece

L 840.00 Atrial Ekartör 1 adet /Atrial Retractor 1 piece

L 849.01 Bağlantı Klempi 1 adet /Fixation Clamp 1 piece

IMA Bleyd / IMA Blade

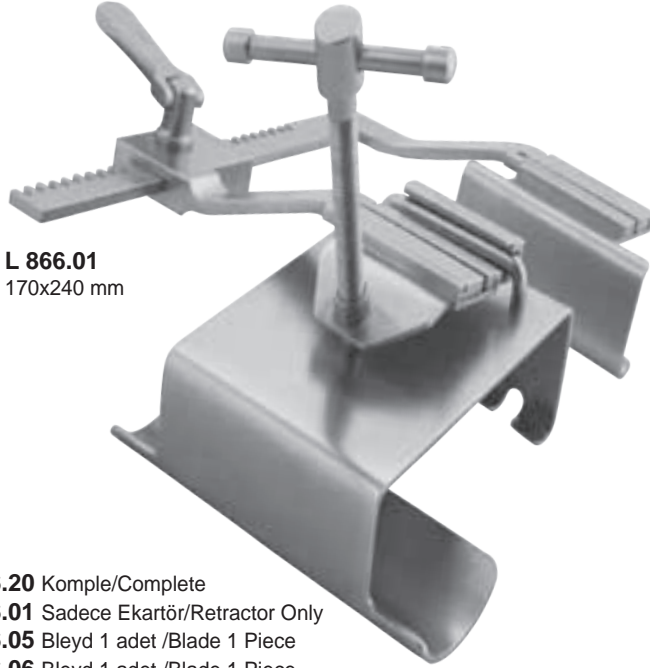

L 866.01
170x240 mm

- L 866.20** Komple/Complete
- L 866.01** Sadece Ekartör/Retractor Only
- L 866.05** Bleyd 1 adet /Blade 1 Piece
- L 866.06** Bleyd 1 adet /Blade 1 Piece
- L 866.08** Bleyd 1 adet /Blade 1 Piece
- L 866.09** Bleyd 1 adet /Blade 1 Piece
- L 866.10** Bleyd 1 adet /Blade 1 Piece



L 866.09

L 866.10



L 866.05
80x100 mm

L 866.06
100x120 mm

Sternum Bleyd / Sternum Blade

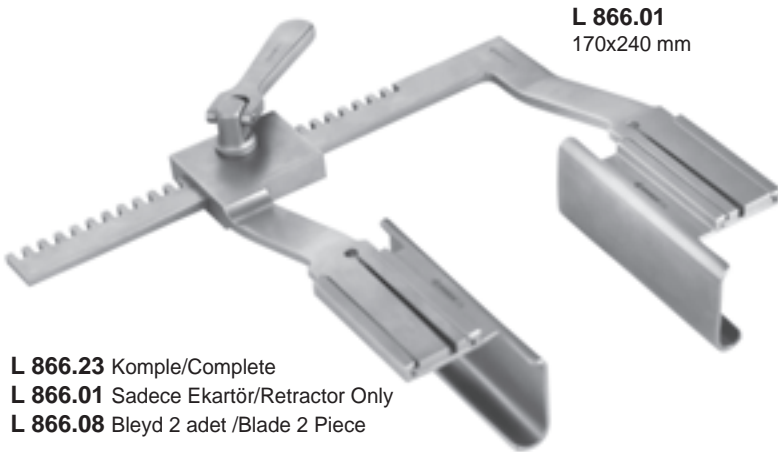

L 866.01
170x240 mm

- L 866.23** Komple/Complete
- L 866.01** Sadece Ekartör/Retractor Only
- L 866.08** Bleyd 2 adet /Blade 2 Piece



L 866.08
38x100 mm

Yan Torasik bleyd/Lateral Thoracic blade

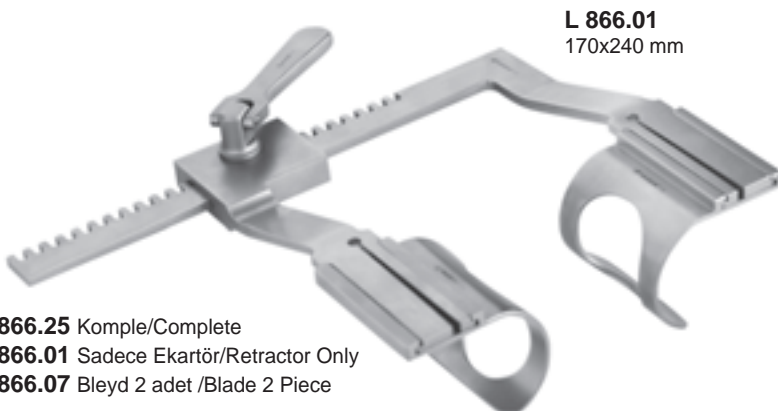

L 866.01
170x240 mm

- L 866.25** Komple/Complete
- L 866.01** Sadece Ekartör/Retractor Only
- L 866.07** Bleyd 2 adet /Blade 2 Piece



L 866.07
50x60 mm

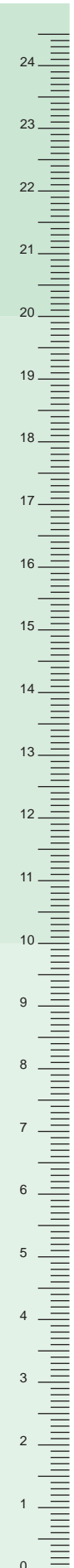

- L 866.00 Komple/Complete
- L 866.01 Sadece Ekartör/Retractor Only
- L 866.04 Bleyd 2 adet/Blade 2 piece
- L 832.00 Çatal Sabitleyici 1 adet/Fork Stabilizer 1piece
- L 833.00 Sabitleyici 1 adet/Stabilizer 1piece
- L 833.02 Sabitleyici 1 adet/Stabilizer 1piece
- L 834.00 Spatula 1 adet/Spatula 1piece
- L 839.00 Atrial Ekartör 1 adet/Atrial Retractor 1piece
- L 840.01 Atrial Ekartör 1 adet/Atrial Retractor 1piece
- L 842.01 Atrial Ekartör 1 adet/Atrial Retractor 1piece
- L 843.01 Atrial Ekartör 1 adet/Atrial Retractor 1piece
- L 847.00 T Çubuk 1 adet/T Bar 1 piece
- L 849.03 Bağlantı Klampi 2 adet/ Fixation Clamp 2 piece

Minimal Invaziv Kardiyak Cerrahi
Minimally Invasive Cardiac Surgery

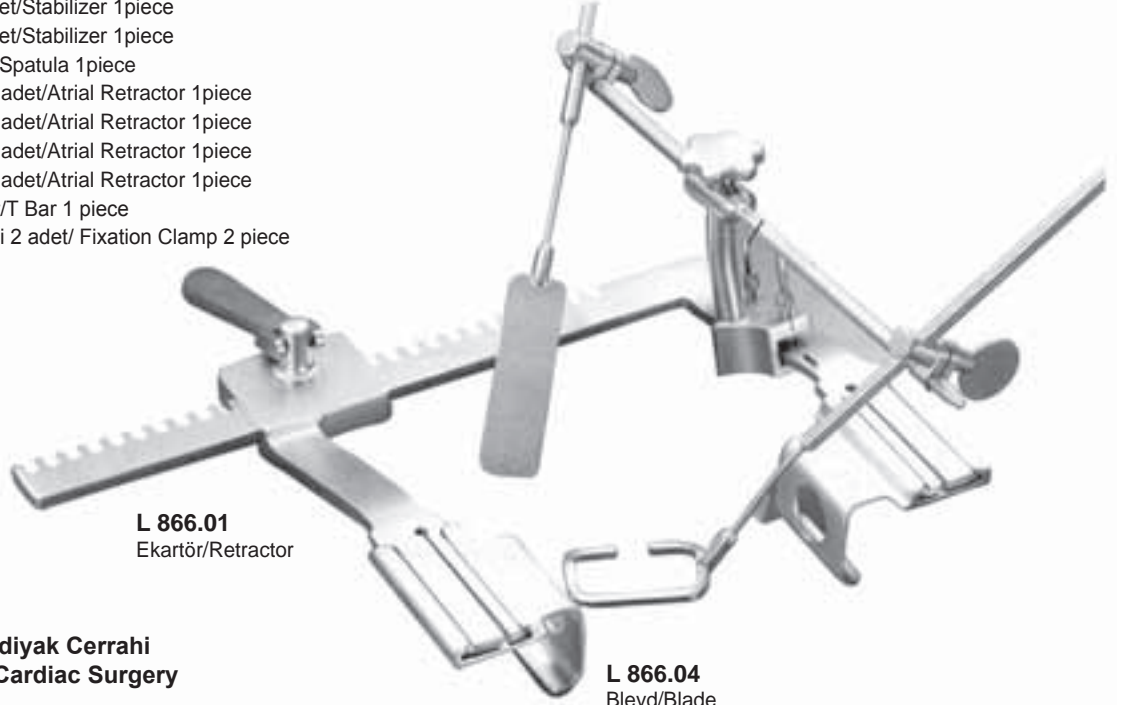

L 866.01
Ekartör/Retractor

L 866.04
Bleyd/Blade

Minimal Invaziv Kardiyak Cerrahi
Minimally Invasive Cardiac Surgery

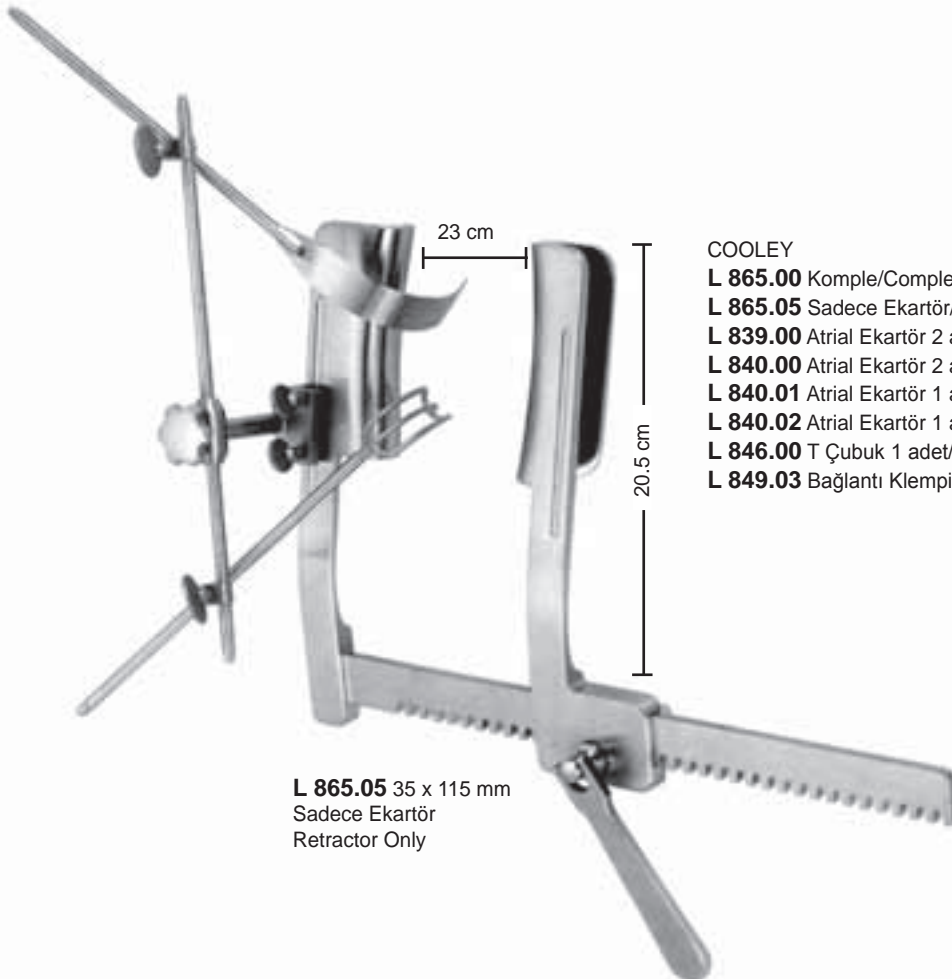

L 865.05 35 x 115 mm
Sadece Ekartör
Retractor Only

COOLEY

- L 865.00 Komple/Complete
- L 865.05 Sadece Ekartör/Retractor Only
- L 839.00 Atrial Ekartör 2 adet/Atrial Retractor 2 piece
- L 840.00 Atrial Ekartör 2 adet/Atrial Retractor 2 piece
- L 840.01 Atrial Ekartör 1 adet/Atrial Retractor 1 piece
- L 840.02 Atrial Ekartör 1 adet/Atrial Retractor 1 piece
- L 846.00 T Çubuk 1 adet/T Bar 1 piece
- L 849.03 Bağlantı Klampi 2 adet/Fixation Clamp 2 piece

Minimal Invaziv Direkt Koroner Arter By-Pass Cerrahi
Minimally Invasive Direct Coronary Artery Bypass Surgery

- L 867.00 Komple/Complete
- L 867.05 Sadece Ekartör/Retractor Only
- L 831.00 Damar Tutucu 1 adet/Vessel Holder 1 piece
- L 832.00 Çatal Sabitleyici 1 adet/Fork Stabilizer 1 piece
- L 833.00 Sabitleyici 1 adet/Stabilizer 1 piece
- L 833.02 Sabitleyici 1 adet/Stabilizer 1 piece
- L 834.00 Spatula 1 adet/Spatula 1 piece
- L 848.00 T Çubuk 1 adet/T Bar 1 piece
- L 849.01 Bağlantı Klempi 4 adet/Fixation Klomp 4 piece



Minimal Invaziv Kardiyak Valf Cerrahi
Minimally Invasive Cardiac Valve Surgery

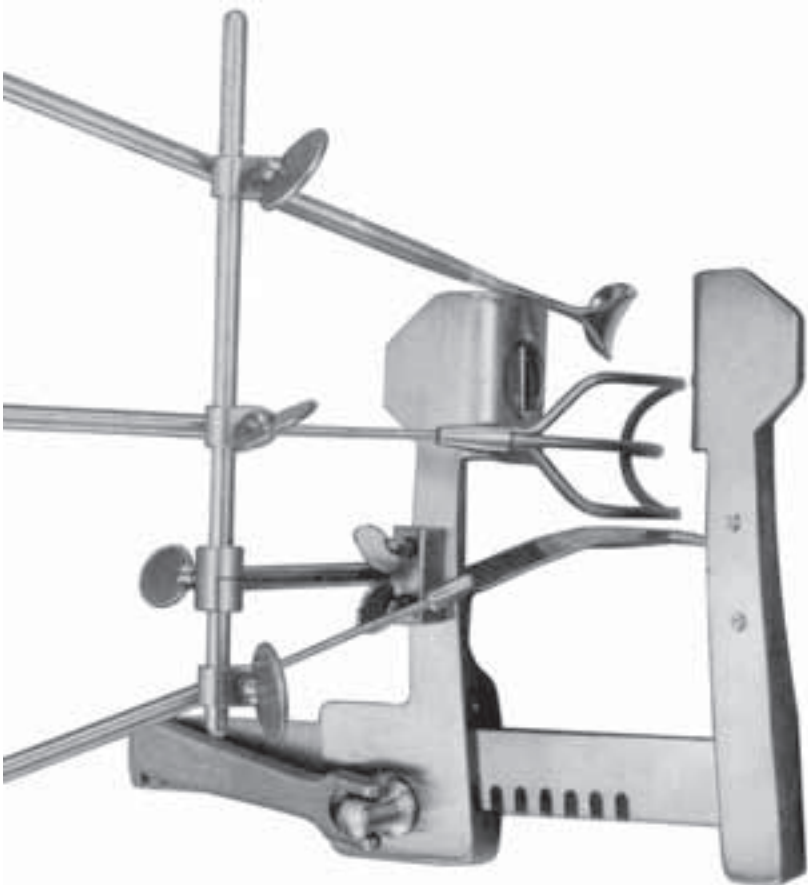

- L 868.00 Komple/Complete
- L 868.05 Sadece Ekartör/Retractor Only
- L 834.00 Spatula 1 adet/Spatula 1 piece
- L 841.00 Atrial Ekartör 1 adet/Atrial Retractor 1 piece
- L 841.01 Atrial Ekartör 1 adet/Atrial Retractor 1 piece
- L 841.02 Atrial Ekartör 1 adet/Atrial Retractor 1 piece
- L 842.00 Atrial Ekartör 1 adet/Atrial Retractor 1 piece
- L 842.01 Atrial Ekartör 1 adet/Atrial Retractor 1 piece
- L 842.02 Atrial Ekartör 1 adet/Atrial Retractor 1 piece
- L 843.00 Atrial Ekartör 1 adet/Atrial Retractor 1 piece
- L 843.01 Atrial Ekartör 1 adet/Atrial Retractor 1 piece
- L 843.02 Atrial Ekartör 1 adet/Atrial Retractor 1 piece
- L 848.00 T Çubuk 1 adet/T Bar 1 piece
- L 849.01 Bağlantı Klempi 4 adet/Fixation Clamp 4 piece



L 831.00
Damar tutucu
Vessel Holder
23 cm



L 832.00
Çatal sabitleyici
Fork stabilizer
23 cm



L 833.00
Sabitleyici/Stabilizer
Küçük/Small
23 cm



L 833.02
Sabitleyici/Stabilizer
Büyük/Large
23 cm



L 834.00
Çok amaçlı spatula
Multi-Purpose Spatula
23 cm



MASETTI
L 835.00
Koroner Sabitleyici
Coronary Stabilizer
44 x 34 x 18 mm
23 cm



MASETTI
L 836.00
Anastomoz ekartörü
Anastomosis retractor
23 cm



RIESS
L 837.00
Koroner Sabitleyici
Coronary Stabilizer
36 x 36 x 13 mm
23 cm

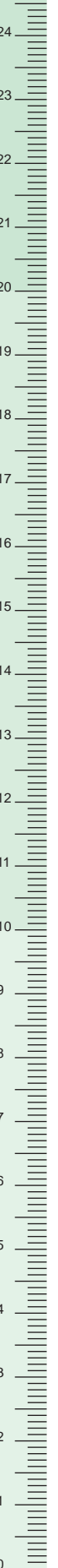



L 838.00
Bükülebilir aydınlatma kolu
Malleable Atrial Arm



L 839.00
Bükülebilir Atrial ekartörü
Malleable Atrial Retractor
23 cm



COOLEY
L 840.00 20 mm
L 840.01 35 mm
L 840.02 45 mm
Atrial ekartörü
Atrial Retractor
23 cm



COOLEY
L 841.00 20 mm
L 841.01 35 mm
L 841.02 45 mm
Bükülebilir Atrial ekartörü
Malleable Atrial Retractor
23 cm



MARBERGER
L 842.00 17 mm
L 842.01 20 mm
L 842.02 23 mm
Atrial ekartörü
Atrial Retractor
23 cm



ROSS
L 843.00 16 x 16 mm
L 843.01 24 x 14 mm
L 843.02 24 x 17 mm
Tırtıllı Atrial ekartörü
Serrated Atrial Retractor
23 cm

T-bar ve bağlantı klempleri
T-bar and fixation Clamp

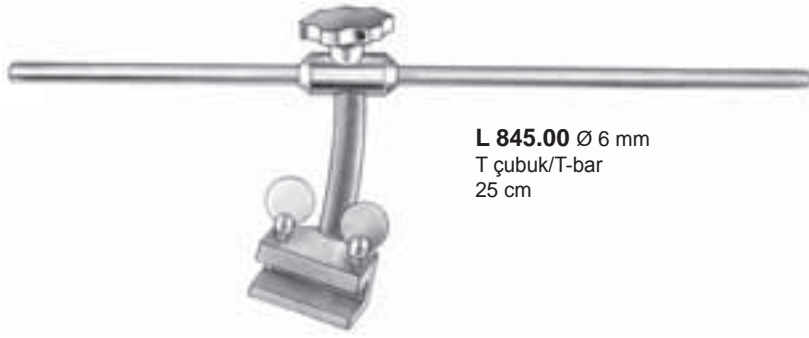

L 845.00 Ø 6 mm
T çubuk/T-bar
25 cm



L 849.01 Ø 6 mm
Bağlantı Klempli
Fixation Clamp



L 846.00 Ø 6 mm
T çubuk/T-bar
25 cm



L 849.02 Ø 6 mm
Bağlantı Klempli
Fixation Clamp



L 847.00 Ø 6 mm
T çubuk/T-bar
27 cm



L 849.05 Ø 6 mm
Bağlantı Klempli
Fixation Clamp

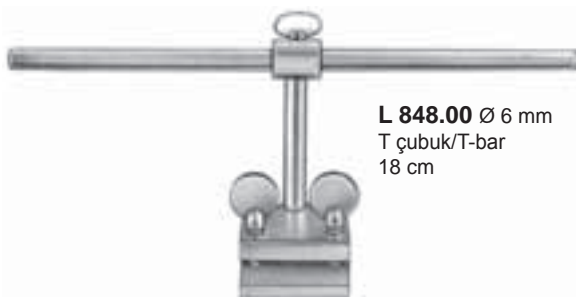

L 848.00 Ø 6 mm
T çubuk/T-bar
18 cm



L 849.03 Ø 6 mm
Bağlantı Klempli
Fixation Clamp

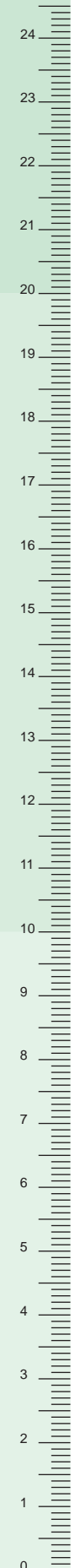



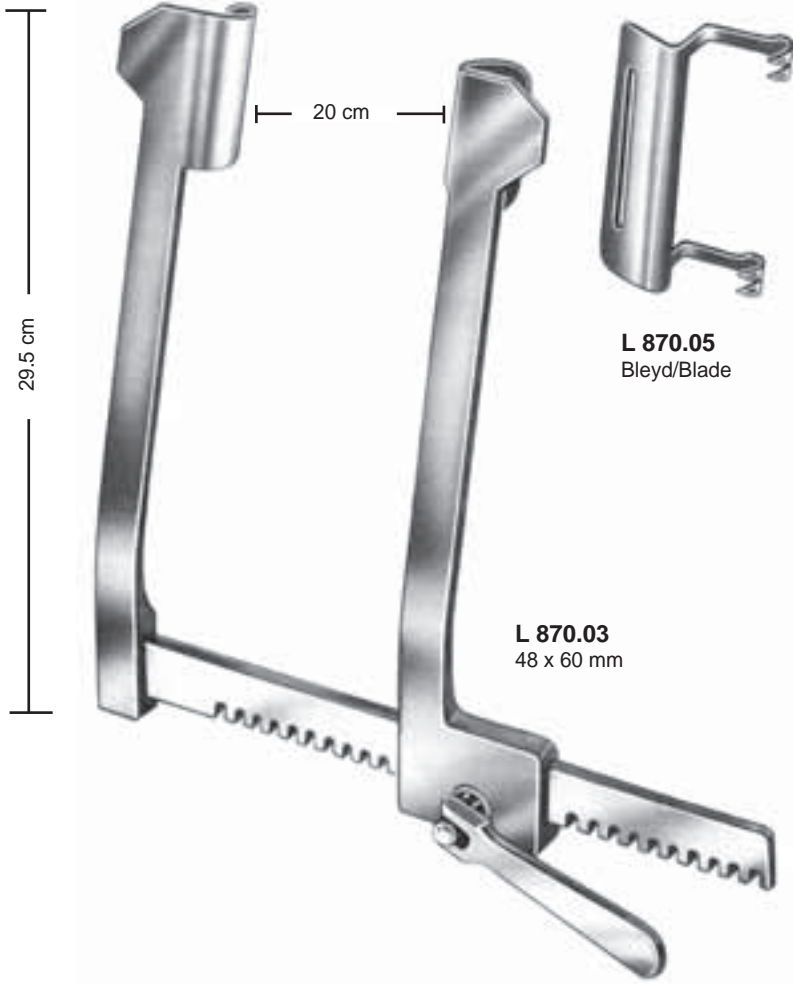

L 870.05
Bleyd/Blade

L 870.03
48 x 60 mm

- L 870.00** Komple/Complete
- L 870.03** Sadece ekartör/Retractor only
- L 870.05** Bleyd/Blade

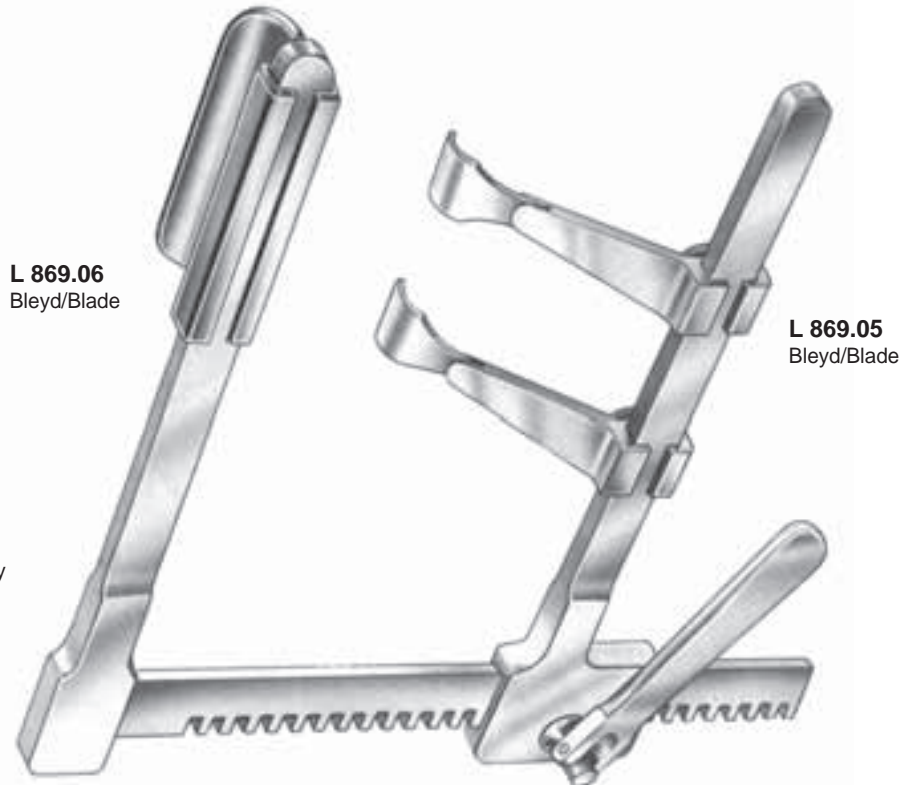

L 869.06
Bleyd/Blade

L 869.05
Bleyd/Blade

- L 869.00** Komple/Complete
- L 869.01** Sadece ekartör/Retractor only
- L 869.05** 1 çift bleyd/ 1 pair blade
- L 869.06** 1 adet bleyd/ 1 each bleyd

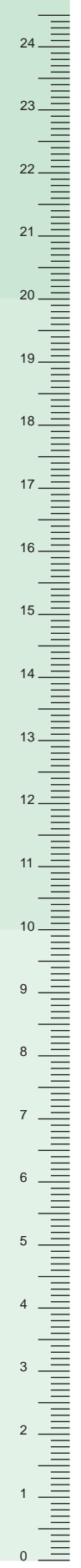

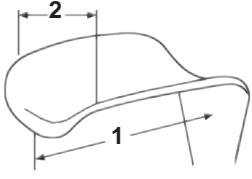

Ekartörler bleydleri için ölçü sistemi

Derinlik : 1
Genişlik : 2

Örnek: 1 x 2 mm

Dimensions for blade size of retractor

Depth: 1 mm
Width: 2 mm

Example: 1 x 2 mm

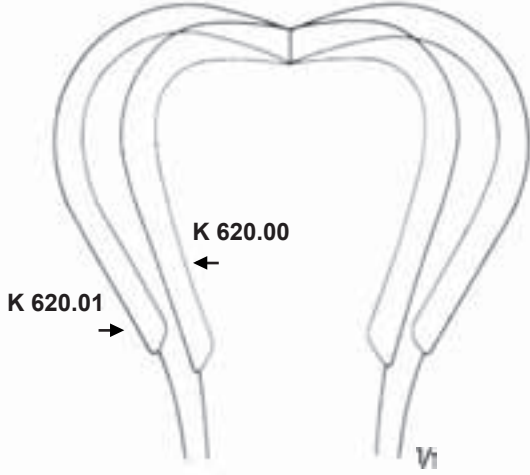

HARRINGTON
K 620.00 123 x 45 mm
K 620.01 123 x 64 mm
Esnek/Flexible
29.5 cm

HARRINGTON-PEMBERTON
K 621.00 175 x 64 mm
Esnek/Flexible
29.5 cm



K 635.02
26 cm

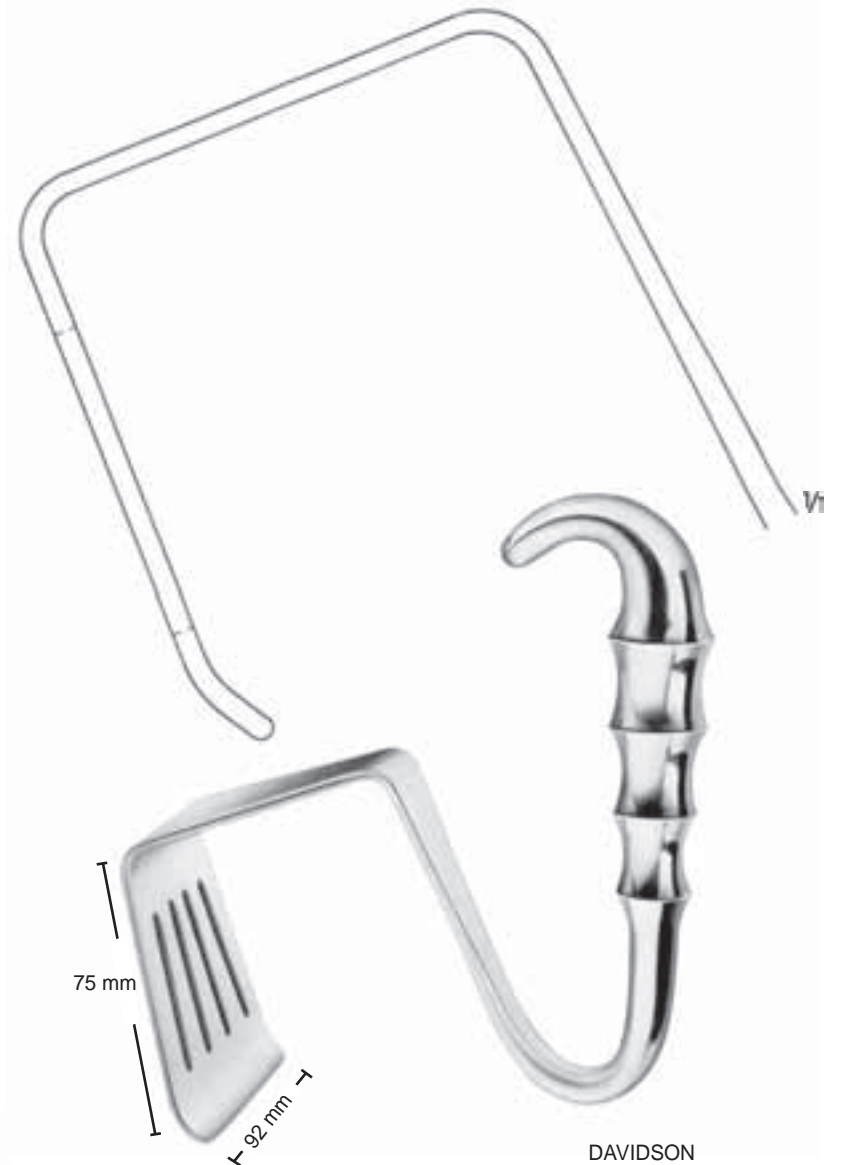

**DAVIDSON
K 637.03
19.5 cm**

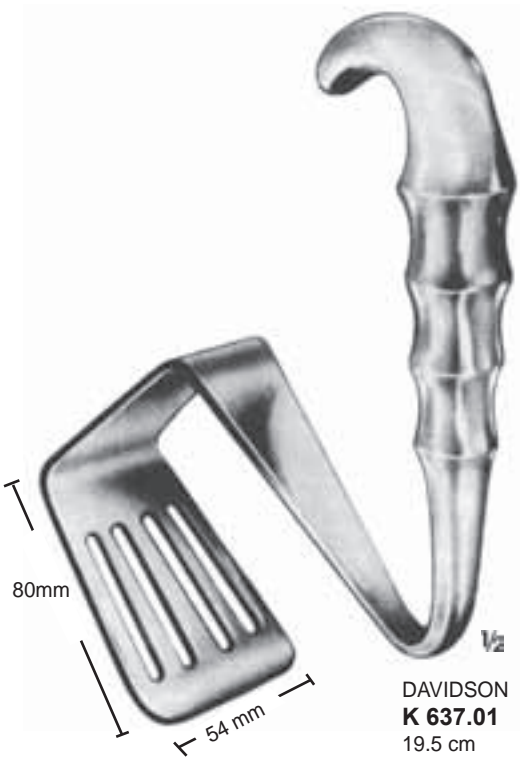

**DAVIDSON
K 637.01
19.5 cm**



ALLISON
K 625.02
25.5 cm



ALLISON
K 625.05
32 cm



K 628.02
30 cm

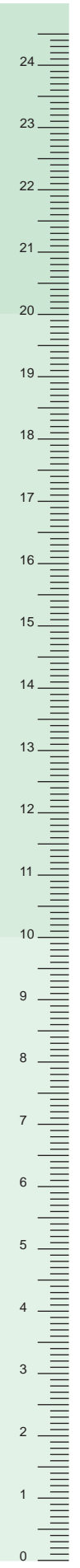





130 x 38 mm

SAUERBRUCH
K 631.00
26 cm

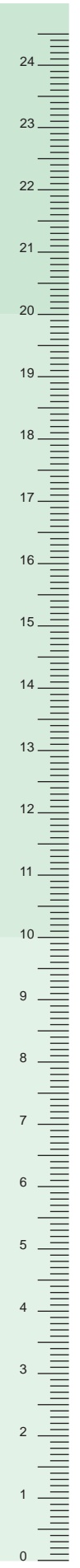



CRAWFORD
K 646.00 15 x 15 mm
K 646.01 15 x 23 mm
 19 cm

ROSS
K 647.00 16 x 15 mm
K 647.01 23 x 13 mm
K 647.02 24 x 16 mm
K 647.03 27 x 13 mm
K 647.04 27 x 27 mm
K 647.05 25 x 39 mm
 24 cm

K 648.00 17 x 11 mm
K 648.01 16 x 23 mm
K 648.02 20 x 25 mm
K 648.03 24 x 27 mm
K 648.04 28 x 20 mm
K 648.05 28 x 29 mm
 27 cm

MOBERG
K 649.00 12 x 5 mm
 17.5 cm

BLANCO
K 650.00 5 mm
K 650.01 7 mm
K 650.02 10 mm
 28 cm



BROCK'S
K 652.00 5 mm
K 652.01 10 mm
K 652.02 12 mm
 19 cm



BROCK'S
K 653.00 13 x 29 mm
 19 cm



BROMPTON
K 654.00 13 x 26 mm
 19 cm



TUDOR-EDWARDS
K 655.00 45 x 50 mm
 16.5 cm





K 694.00
17 x 21 mm



K 694.01
16 x 23 mm



K 694.02
20 x 25 mm



K 694.03
24 x 27 mm



K 694.04
28 x 20 mm



K 694.05
28 x 29 mm



BOROWSKI
K 694.00 - K 694.05
Bükülebilir şaft/Malleable shaft
27 cm



COOLEY
K 695.00 45 x 30 mm
K 695.01 45 x 35 mm
K 695.02 45 x 48 mm
Ince Dişli / Slightly serrated
26.5 cm



COOLEY
K 696.00 45 x 30 mm
K 696.01 45 x 35 mm
K 696.02 45 x 48 mm
Dişsiz / Unserrated
24.5 cm



COOLEY
K 697.02 25 x 46 mm
Sol/Left
28 cm

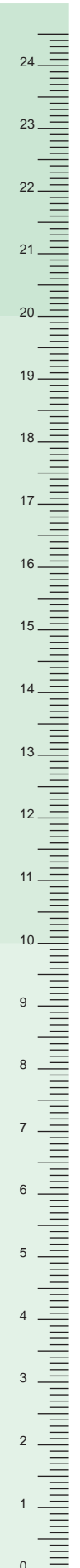



Vi
COOLEY
K 695.00P 45 x 30 mm
Ince Dişli / Slightly serrated
26.5 cm



Vi
COOLEY
K 695.01P 45 x 35 mm
Ince Dişli / Slightly serrated
26.5 cm



Vi
COOLEY
K 695.02P 45 x 48 mm
Ince Dişli / Slightly serrated
Sağ/Right
27 cm



Vi
COOLEY
K 696.02P 45 x 48 mm
27 cm



Vi
COOLEY
K 697.02P 25 x 46 mm
Sol/Left
28 cm

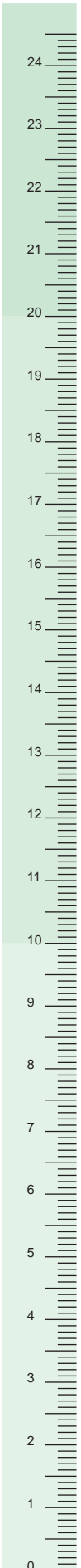

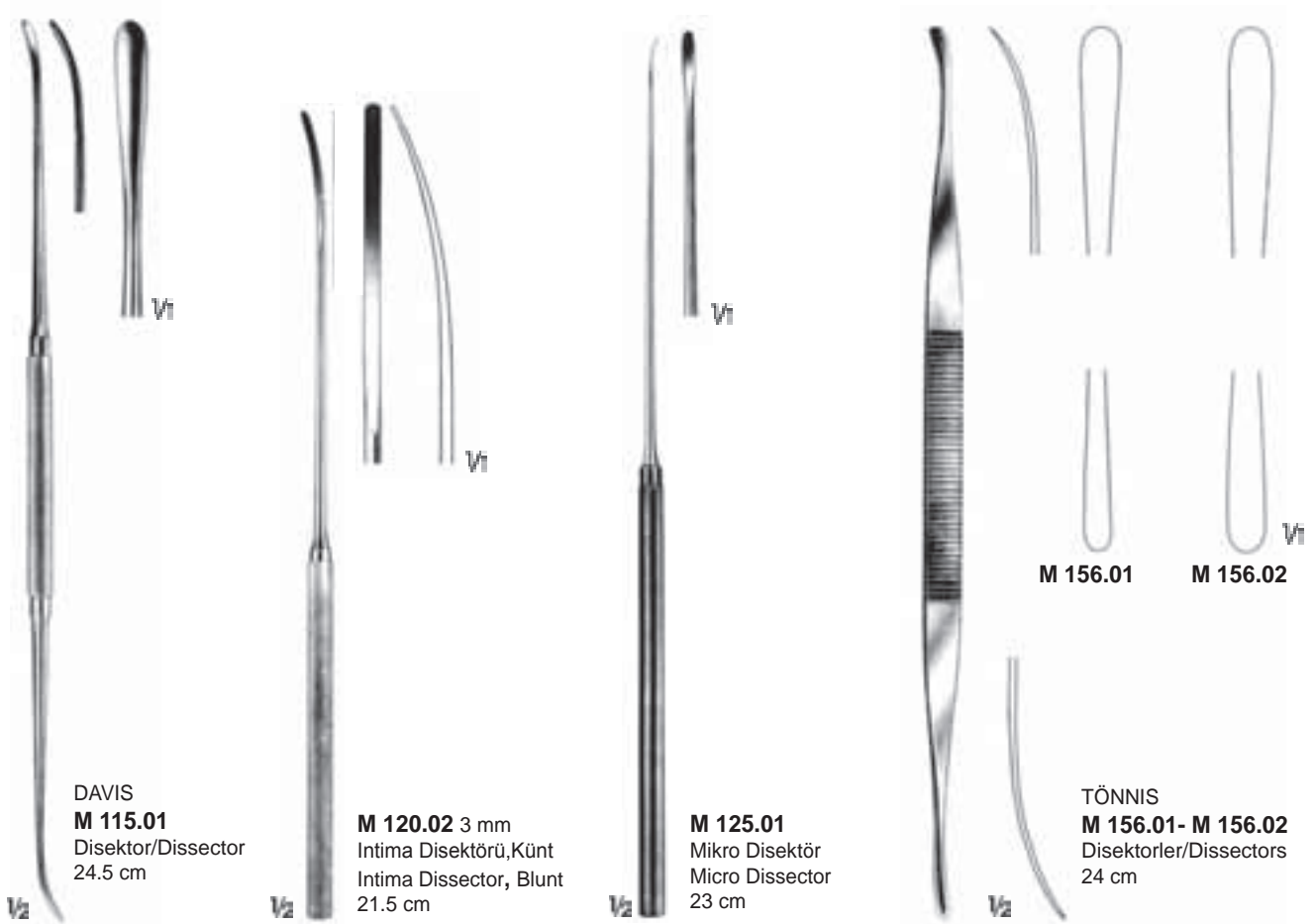
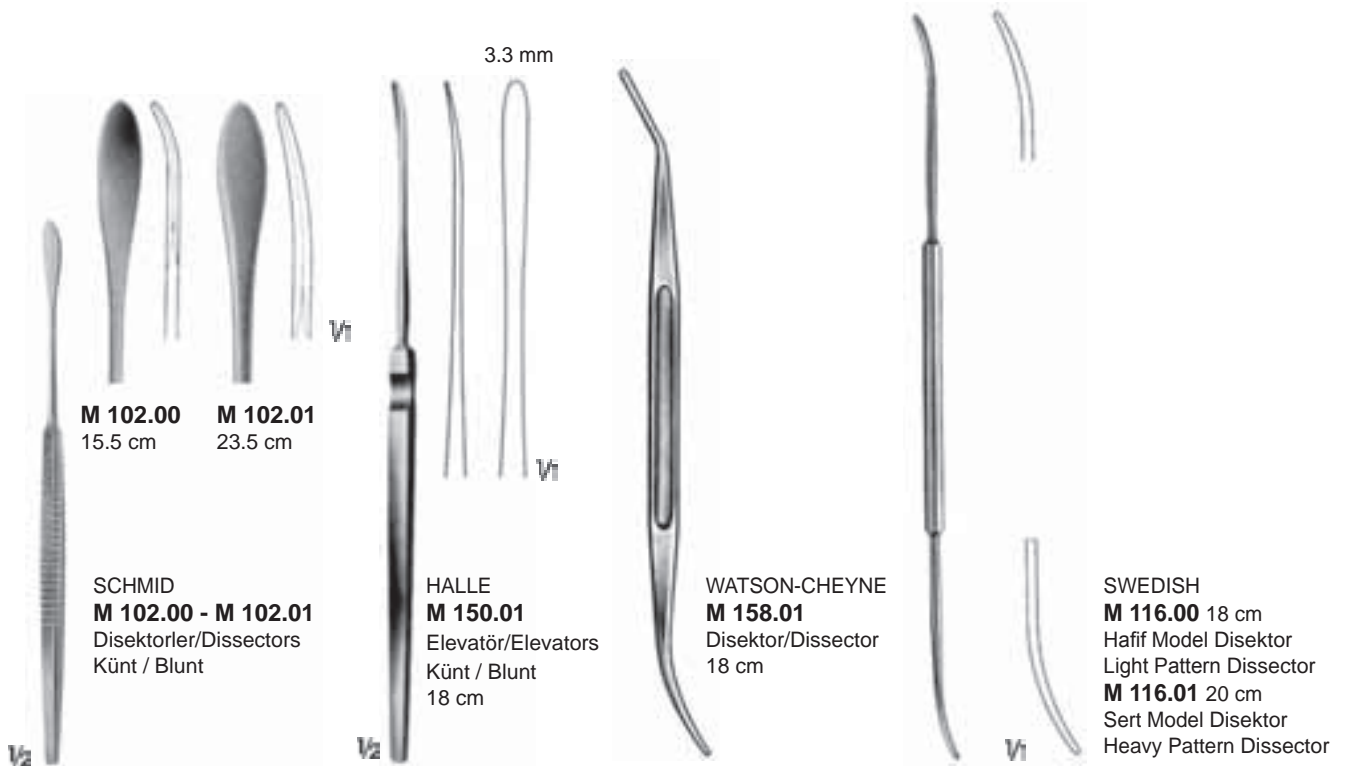

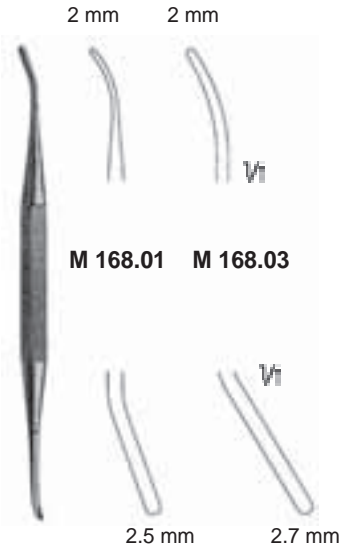

WATSON-CHEYNE
M 168.01 13 cm
M 168.03 19 cm
Disektörler/Dissectors



ADSON
M 237.10
Raspa/Raspatories
16.5 cm



PENNYBAKER
M 238.00
Raspa/Raspatories
16.5 cm



ROBB
M 582.00
Disektör/Dissector
24 cm



ROBB
M 582.01
Disektör/Dissector
24 cm



ROBB
M 582.02
Disektör/Dissector
24 cm



ROBB
M 582.03
Disektör/Dissector
24 cm

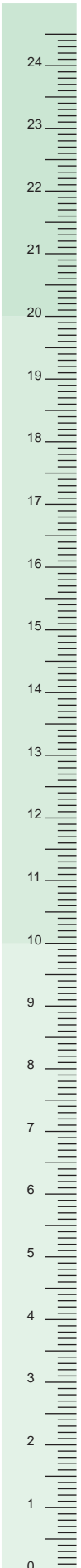



SEMB
M 289.01 - M 289.05

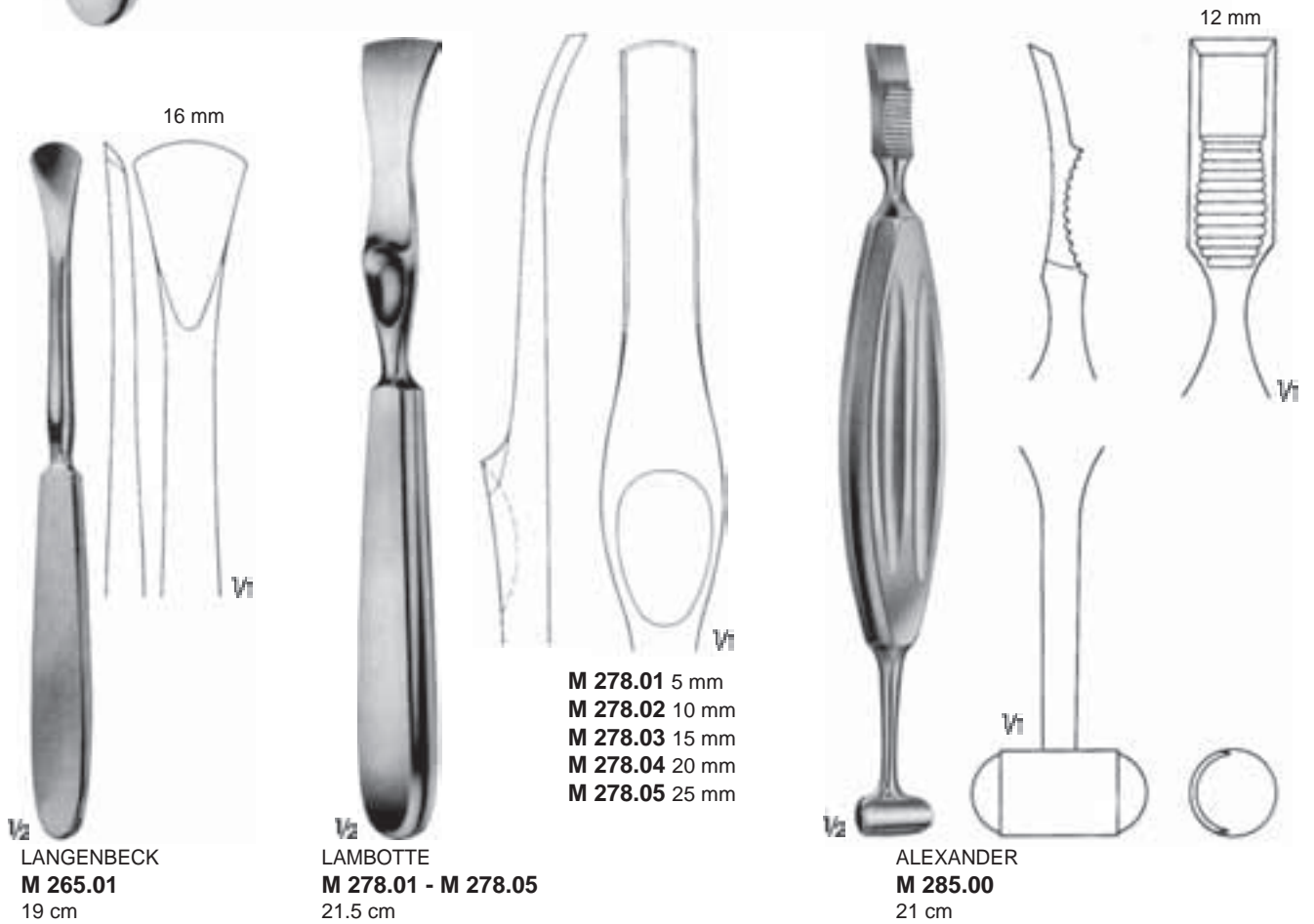

$\frac{1}{2}$
LANGENBECK
M 265.01
19 cm

$\frac{1}{2}$
LAMBOTTE
M 278.01 - M 278.05
21.5 cm

$\frac{1}{2}$
ALEXANDER
M 285.00
21 cm

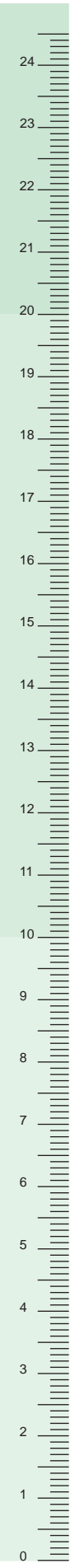



NABATOFF

- J 500.00** Damar temizleme seti/Vein stripper set, consisting of
 J 500.01 Metal Kutu/Metal case
 J 500.11 Esnek kablo 90 cm/Flexible cable 90 cm
 J 500.03 Esnek plastik sonda ucu/Flexible plastic probe tip
 J 500.04 Metal sonda ucu/Metal Probe tip
 J 500.05 Metal uc/Metal end Ø 6 mm/Tip
 J 500.06 Metal uc/Metal end Ø 9 mm/Tip
 J 500.07 Metal uc/Metal end Ø 12 mm/Tip
 J 500.08 Metal uc/Metal end Ø 15 mm/Tip
 J 500.10 Esnek kablo sapı/Handle for flexible cable



J 500.04
Ø 3 mm
Metal sonda ucu
Metal Probe tip



J 500.05
Ø 6 mm



J 500.06
Ø 9 mm



J 500.07
Ø 12 mm



J 500.08
Ø 15 mm

J 500.03
Esnek plastik sonda ucu
Flexible plastic probe tip



J 502.01
Esnek kablo
Flexible cable



J 500.11 90 cm
Esnek kablo/Cable Flexible



J 502.03
Ø 3 mm



J 502.04
Ø 4 mm



J 502.05
Ø 5 mm



VARADY

- J 502.00** Mini damar temizleme seti
 Mini vein stripper set
 J 500.01 Metal kutu/Metal case
 J 502.01 Esnek kablo 45 cm/Flexible cable 45 cm
 J 502.03 Metal uc Ø 3 mm/Tip 3 mm
 J 502.04 Ø 4 mm
 J 502.05 Ø 5 mm



J 500.10
Sadece sap
Handle only

J 500.11 90 cm
J 500.12 120 cm
Esnek kablo/Cable flexible



VARADY
M 580.05
Çıkartıcı/Extractor
17 cm



VARADY
M 580.06
Çıkartıcı/Extractor
17 cm



VARADY
M 580.07
Spatula/Spatula
17.5 cm



VARADY
M 580.00
Disektor/Dissector
18 cm



VARADY
M 580.01
Çıkartıcı/Extractor
18 cm



VARADY
M 580.02
Çıkartıcı/Extractor
18 cm



BABCOCK
J 504.02 40 cm
J 504.03 50 cm
J 504.04 65 cm
J 504.05 80 cm
 Varis sondaları
 Probes for varicose veins



MYERS
J 506.02 - J 506.05
 Damar temizleyiciler
 Vein strippers
 91 cm

Ø 3.2 mm



J 506.02 Ø 6 mm
J 506.03 Ø 9 mm
J 506.04 Ø 12.5 mm
J 506.05 Ø 16 mm



BLAKE
E 620.00
 20.5 cm



DE BAKEY
J 510.02 - J 510.17 19 cm
J 511.02 - J 511.17 38 cm
 Damar dilatörleri, bükülebilir
 Vascular dilators, malleable



J 510.02 Ø 0.5 mm
J 510.03 Ø 1.0 mm
J 510.04 Ø 1.5 mm
J 510.05 Ø 2.0 mm
J 510.06 Ø 2.5 mm
J 510.07 Ø 3.0 mm
J 510.08 Ø 3.5 mm
J 510.09 Ø 4.0 mm



J 510.10 Ø 4.5 mm
J 510.11 Ø 5.0 mm
J 510.14 Ø 6.0 mm
J 510.12 Ø 7.0 mm
J 510.15 Ø 8.0 mm
J 510.13 Ø 9.0 mm
J 510.17 Ø 10.0 mm

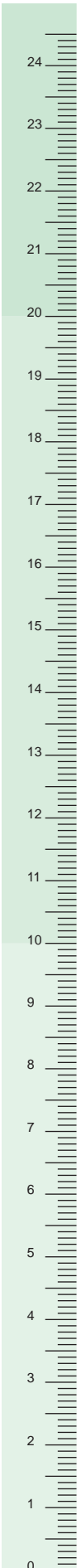



J 508.00
Ø 0.5 mm

J 508.01
Ø 1.0 mm

J 508.02
Ø 1.5 mm

J 508.03
Ø 2.0 mm

J 508.04
Ø 2.5 mm

J 508.05
Ø 3.0 mm

J 508.06
Ø 4.0 mm

J 508.07
Ø 5.0 mm

COOLEY
J 508.00 - J 508.07
Bükülebilir/Malleable
13 cm



J 513.00
J 514.00
J 515.00
J 516.00
Ø 0.5 mm

J 513.01
J 514.01
J 515.01
J 516.01
Ø 1.0 mm

J 513.02
J 514.02
J 515.02
J 516.02
Ø 1.5 mm

J 513.03
J 514.03
J 515.03
J 516.03
Ø 2.0 mm

J 513.04
J 514.04
J 515.04
J 516.04
Ø 2.5 mm

J 513.05
J 514.05
J 515.05
J 516.05
Ø 3.0 mm

J 513.06
J 514.06
J 515.06
J 516.06
Ø 3.5 mm

J 513.07
J 514.07
J 515.07
J 516.07
Ø 4.0 mm

J 513.08
J 514.08
J 515.08
J 516.08
Ø 4.5 mm

J 513.09
J 514.09
J 515.09
J 516.09
Ø 5.0 mm

J 513.11
J 514.11
J 515.11
J 516.11
Ø 7.0 mm

J 513.13
J 514.13
J 515.13
J 516.13
Ø 9.0 mm

GARRET
J 513.00 - J 513.13 14 cm
J 514.00 - J 514.13 19 cm
J 515.00 - J 515.13 21 cm
J 516.00 - J 516.13 35 cm
Bükülebilir/Malleable



F 529.00 - F 529.10
Yumuşak tel / Wire soft
10 mt.

F 529.00 Ø 0.2 mm
F 529.01 Ø 0.3 mm
F 529.02 Ø 0.4 mm

F 529.03 Ø 0.5 mm
F 529.04 Ø 0.6 mm
F 529.05 Ø 0.7 mm

F 529.06 Ø 0.8 mm
F 529.07 Ø 0.9 mm
F 529.08 Ø 1.0 mm

F 529.09 Ø 1.2 mm
F 529.10 Ø 1.5 mm

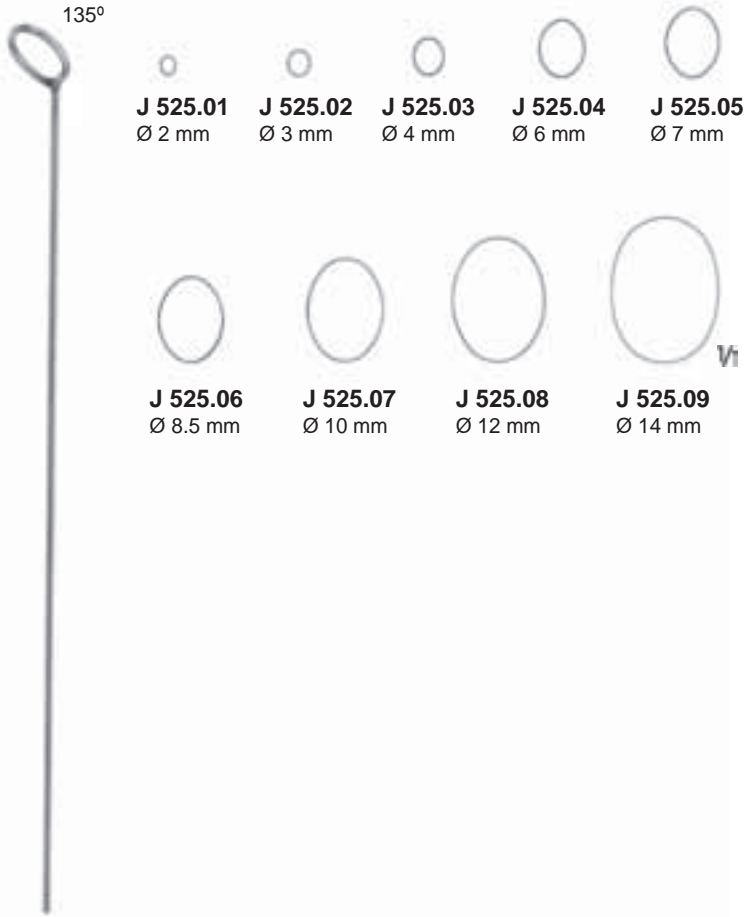

J 525.01 - J 525.09
Temizleyici/Strippers
55 cm



J 525.12
J 525.01 - J 525.09 için Sap
J 525.01 - J 525.09 For Handle
11 cm

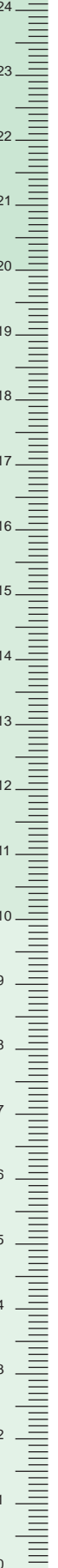



RUMEL-BELMONT
J 530.01 Ø 4.0 mm
J 530.02 Ø 6.4 mm
32.5 cm



J 530.05
Mandre alyen klavuzu
Mandrin allein guide only



J 530.06
Mandre alyen klavuzu
Mandrin allein guide only

**COOLEY****J 518.01A** Ø 0.5 mm**J 518.02A** Ø 1.0 mm**J 518.03A** Ø 1.5 mm**J 518.04A** Ø 2.0 mm**J 518.05A** Ø 2.5 mm**J 518.06A** Ø 3.0 mm

Alüminyum Sap

Alüminyum Handle

15 cm

J 519.01A Ø 0.5 mm**J 519.02A** Ø 1.0 mm**J 519.03A** Ø 1.5 mm**J 519.04A** Ø 2.0 mm**J 519.05A** Ø 2.5 mm**J 519.06A** Ø 3.0 mm

Alüminyum Sap

Alüminyum Handle

20 cm

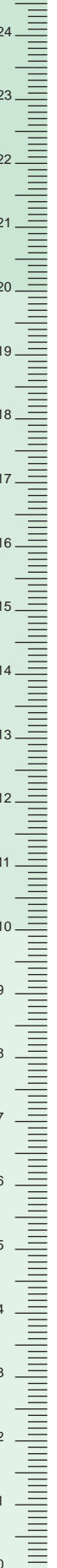

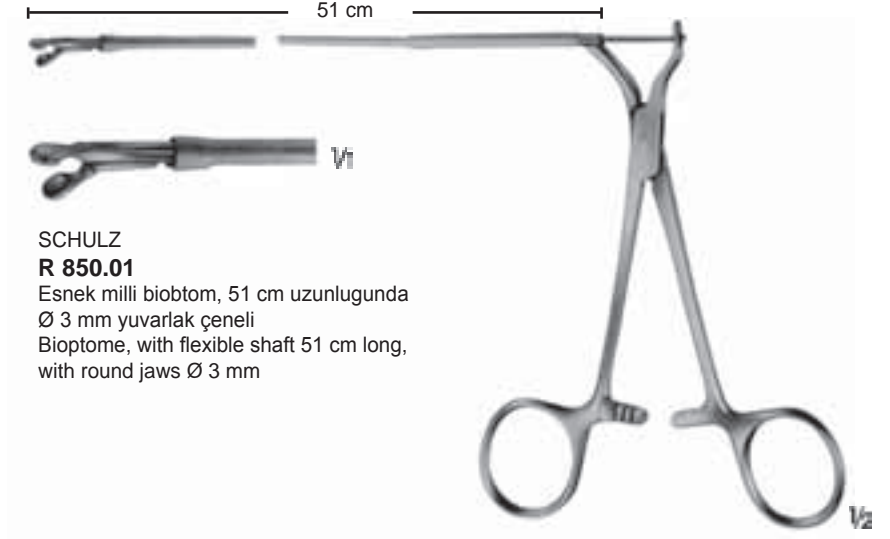

TUBBS
R 860.01
Mitral valf dilatörü
Dilatör for mitral valve

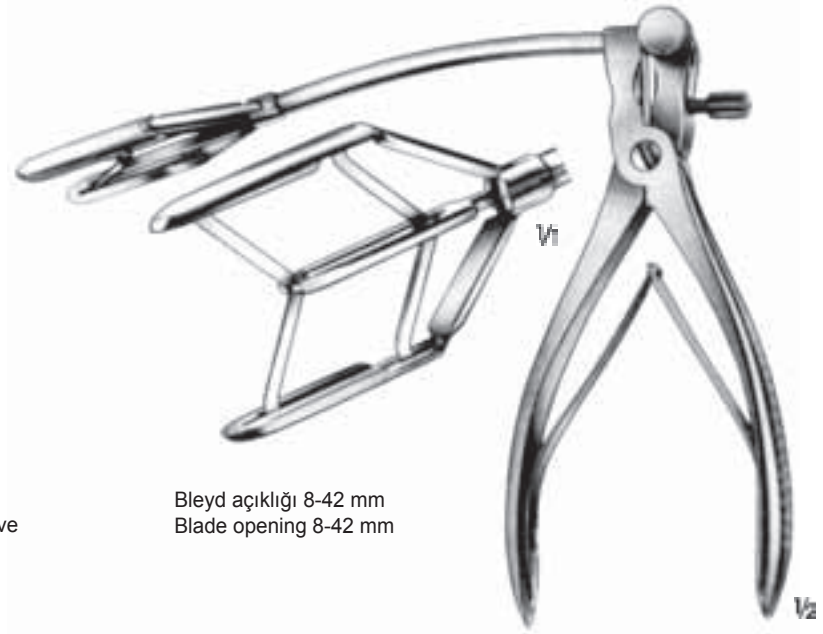

COOLEY
R 861.01
Mitral valf dilatörü
Dilatör for mitral valve

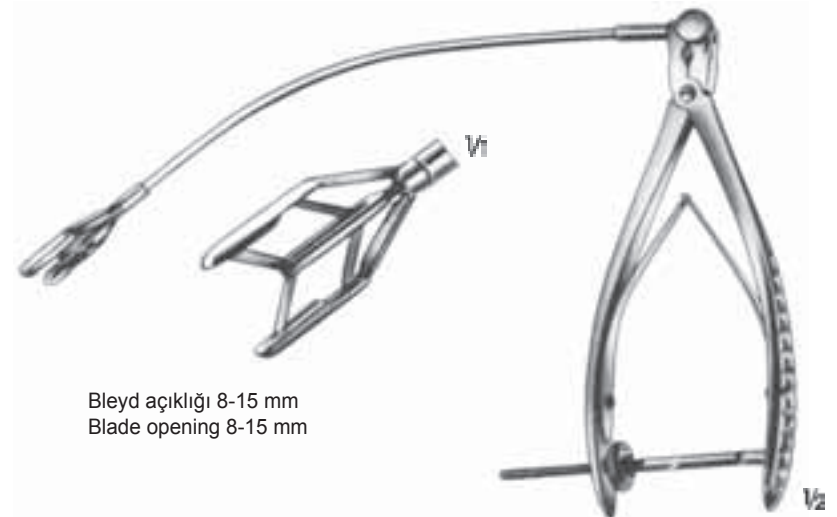

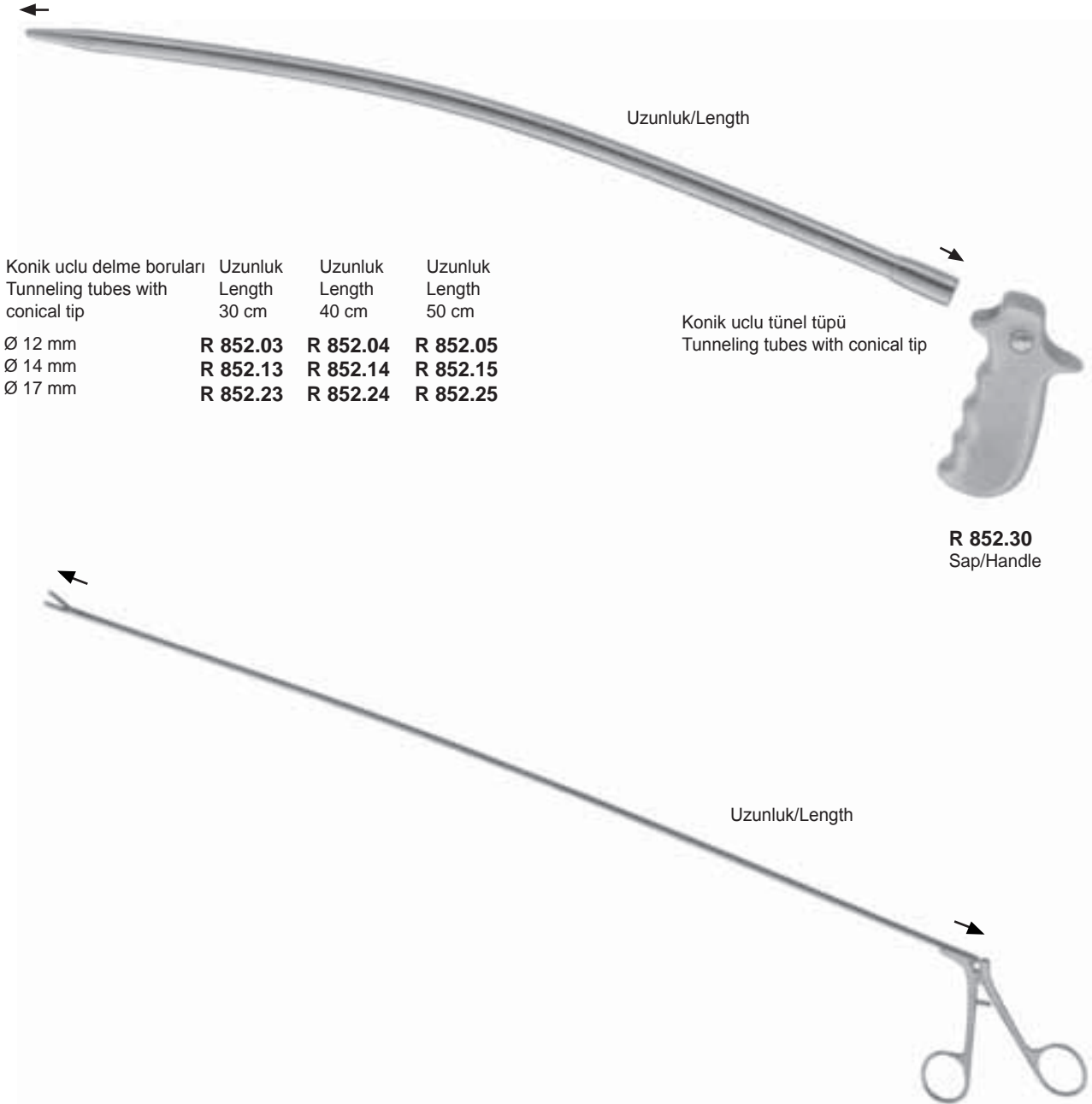

Konik uclu delme boruları Tunneling tubes with conical tip	Uzunluk Length 30 cm	Uzunluk Length 40 cm	Uzunluk Length 50 cm
Ø 12 mm	R 852.03	R 852.04	R 852.05
Ø 14 mm	R 852.13	R 852.14	R 852.15
Ø 17 mm	R 852.23	R 852.24	R 852.25

Konik uclu tünel tüpü
Tunneling tubes with conical tip

R 852.30
Sap/Handle

R 855.33 30 cm
R 855.34 40 cm
R 855.35 50 cm
Pensler/Forceps

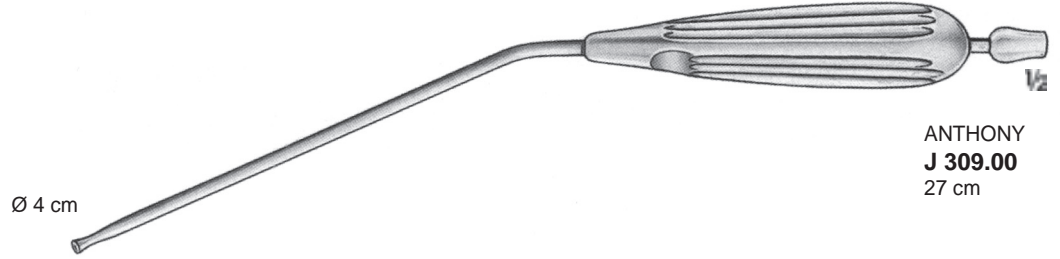

ANTHONY
J 309.00
27 cm

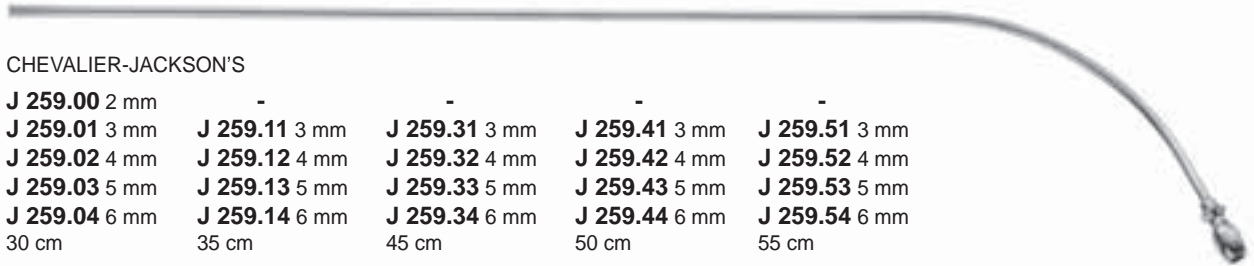

CHEVALIER-JACKSON'S

J 259.00 2 mm	-	-	-	-
J 259.01 3 mm	J 259.11 3 mm	J 259.31 3 mm	J 259.41 3 mm	J 259.51 3 mm
J 259.02 4 mm	J 259.12 4 mm	J 259.32 4 mm	J 259.42 4 mm	J 259.52 4 mm
J 259.03 5 mm	J 259.13 5 mm	J 259.33 5 mm	J 259.43 5 mm	J 259.53 5 mm
J 259.04 6 mm	J 259.14 6 mm	J 259.34 6 mm	J 259.44 6 mm	J 259.54 6 mm
30 cm	35 cm	45 cm	50 cm	55 cm



BROCK'S

R 209.00 28 cm	R 209.10 28 cm
R 209.01 35 cm	R 209.11 35 cm
R 209.02 50 cm	R 209.12 50 cm
R 209.03 60 cm	R 209.13 60 cm
Düz/Straight	Yukarı açılı/Angled upwards



ALLENBERG
G 066.00
Eğri/Curved
54 cm



G 066.05
4 cm

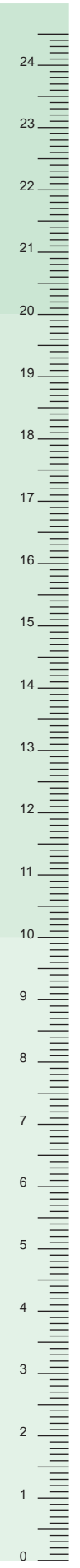



E 335.00
Göğüs tüpü yerleştirme pensi
Chest Tube Placement forceps
24 cm



E 336.00
Göğüs tüpü yerleştirme pensi
Chest Tube Placement forceps
Kilitli/With Ratched
24 cm



BROMPTON
L 290.00
Makaralı tüp sağıcı
Tube milking Roller

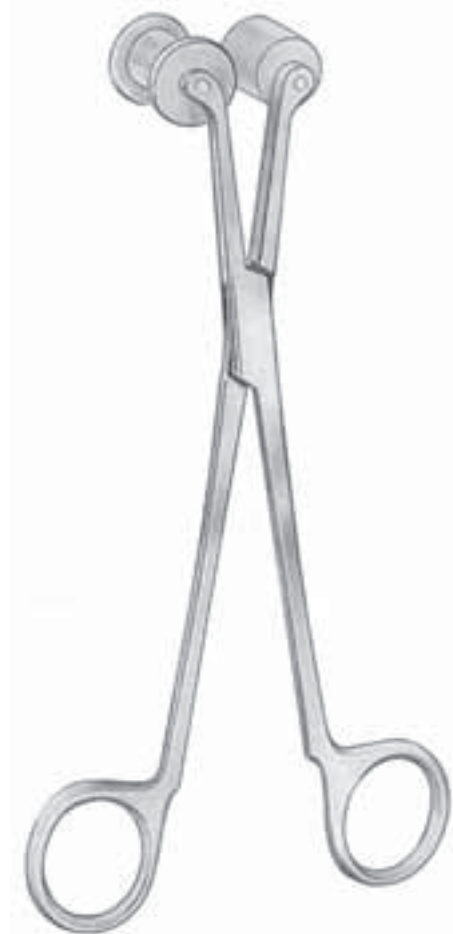

GUNNAR HEY
G 888.00
Makaralı tüp sağıcı
Tube milking Roller



E 503.00 33 mm
17 cm
E 503.01 61 mm
29 cm
E 503.02 86 mm
30 cm



E 504.00 33 mm
16 cm
E 504.01 45 mm
18 cm
E 504.02 61 mm
26 cm



E 505.01 61 mm
26 cm
E 505.02 86 mm
29 cm





WITT
J 710.00 1.5 x 35 mm
J 710.02 1.5 x 51 mm
Sternal delme iğnesi,
luer bağlantılı
Sternal puncture needle
with Luer Cone

V1



Tek ağız tırtıllı
One jaw serrated

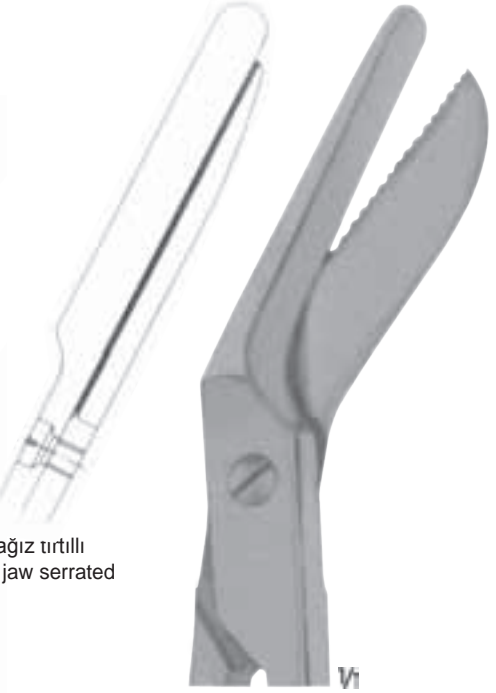

V1

BRAUN-STADLER
C 604.01
Çocuklar için sternum makası
Sternum shears for children
20 cm



V2

OELERT
T 450.00
Sternal Ekartörü/Sternum Retractor
28 cm



V2

SCHUMACHER
P 505.00
Sternal makası/Sternum shears
21 cm



V2

LEBSCHKE
M 598.00
Sternal Çizili/Sternum Chisels
20 cm



fig. 000 00 0 1

N 176.01 2.5 mm
N 176.02 3.4 mm
N 176.03 4.2 mm
N 176.04 5.2 mm

fig. 2 3 4

N 176.05 6.3 mm
N 176.06 7.4 mm
N 176.07 8.0 mm

SCHEDÉ
N 176.01 - N 176.07
17 cm



fig. 000 00 0 1

N 177.01 3 mm
N 177.02 4 mm
N 177.03 5 mm
N 177.04 6 mm

fig. 2 3 4

N 177.05 8 mm
N 177.06 10 mm
N 177.07 12 mm

BRUNS
N 177.01 - N 177.07
16.5 cm



fig. 0000 000 00 0 1 2

N 179.01 2.8 mm
N 179.02 3.6 mm
N 179.03 4.4 mm
N 179.04 5.2 mm
N 179.05 6.8 mm
N 179.06 8.5 mm

fig. 3 4 5 6

N 179.07 10 mm
N 179.08 11.5 mm
N 179.09 13 mm
N 179.10 14.5 mm

WOLKMANN
N 179.01 - N 179.10
17 cm

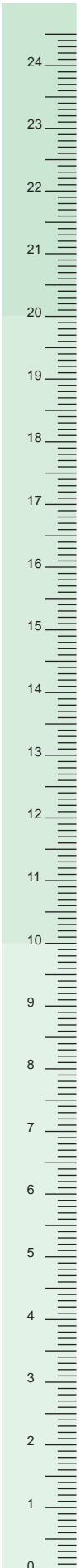
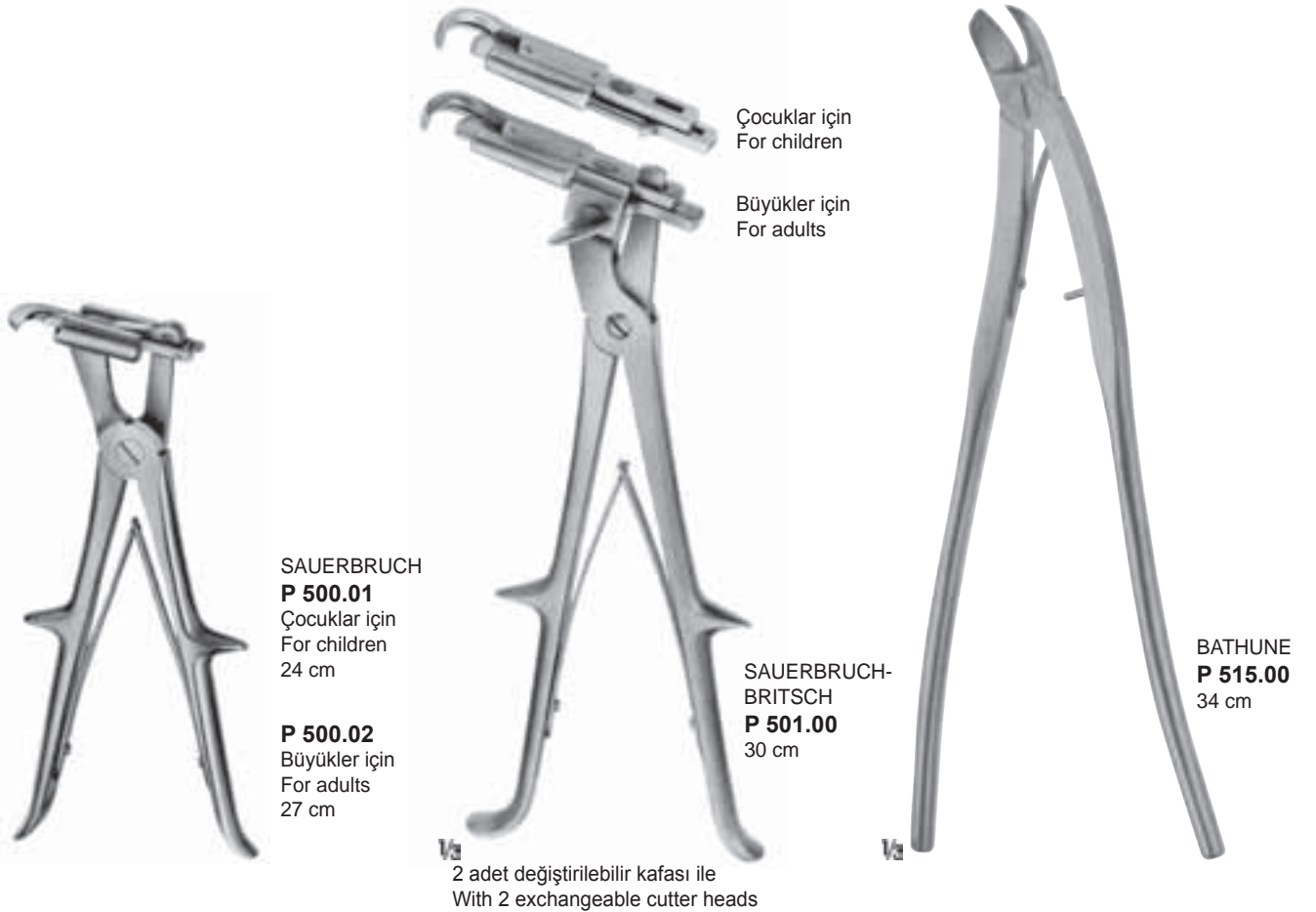
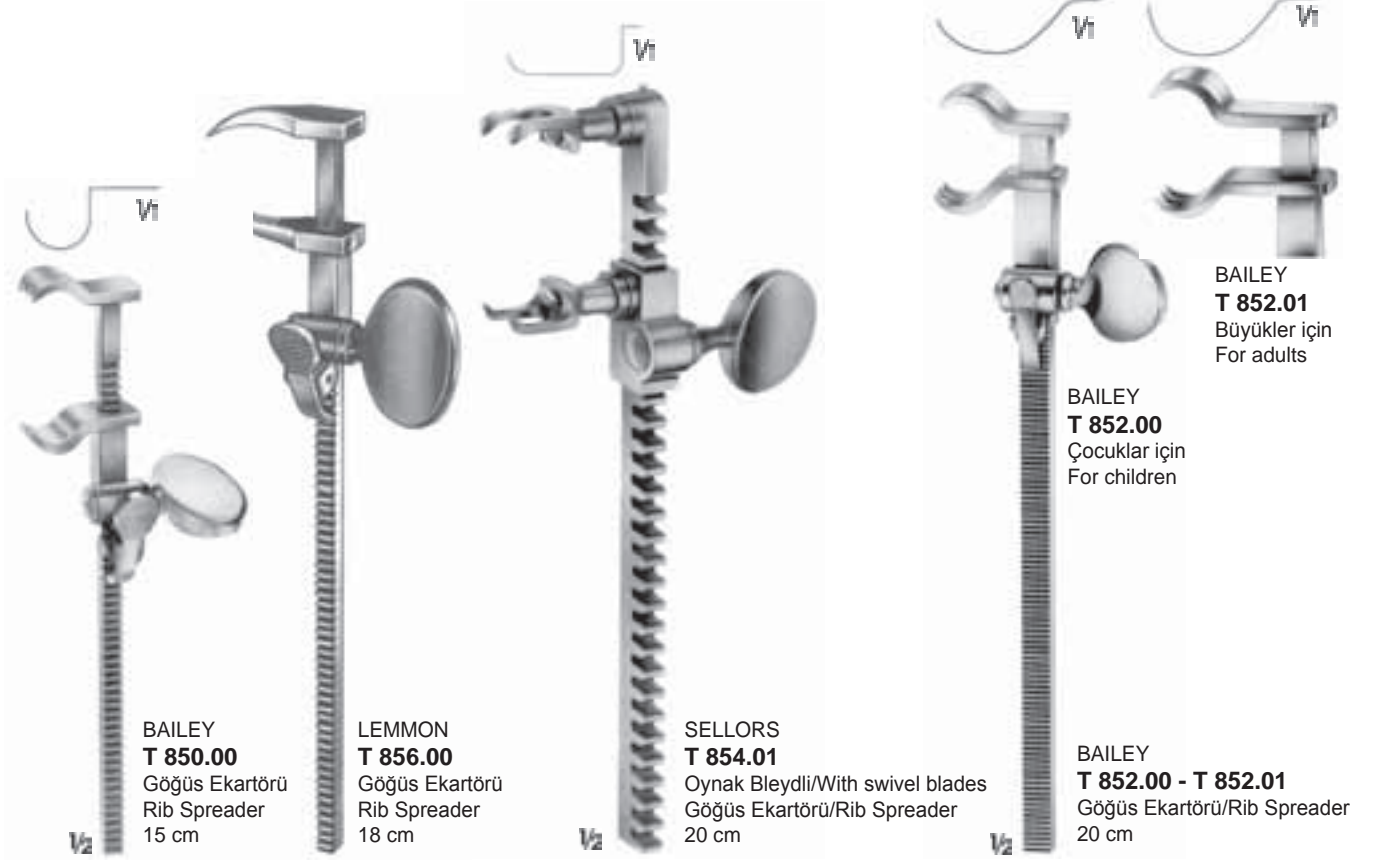

fig. 00 1

N 180.01 3.4 mm
N 180.02 5.2 mm

WILLIGER
N 180.01 - N 180.02
17 cm







GLUCK
P 510.00
19 cm



COLLIN
P 511.00
19.5 cm



P 513.01
23 cm



GIERTZ - STILLE
P 502.01
25 cm



BRUNNER
P 520.01
Universal Model/Universal Pattern
34 cm



SAUERBRUCH-FREY
P 522.01
37 cm

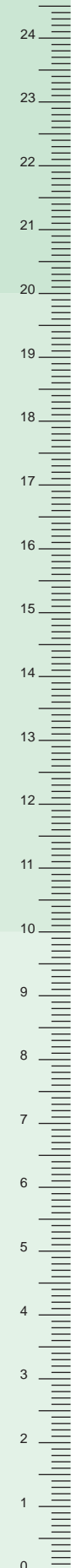



SEMB
P 135.00
19 cm



SEMB
P 136.00
19 cm



P 150.00
20 cm



LANGENBECK
P 151.00
20.5 cm



FERGUSSON
P 152.00
20.5 cm



P 310.01



P 310.02



Vt



V2

ECHLIN
P 310.01 - P 310.02
23 cm



V2

STILLE
P 315.01
23.5 cm

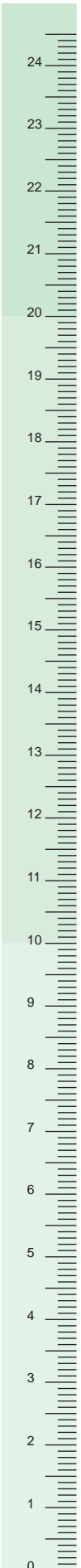





MARKWALDER
P 330.00
19 cm



SAUERBRUCH-CORYLLOS
P 333.01 - P 335.01
31 cm



P 333.01



P 335.01

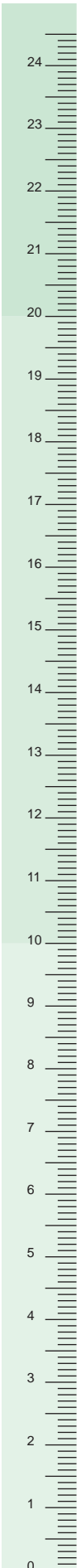



P 350.00
Eğri/Curved
13 cm



LISTON
P 358.01-P 358.04
Düz/Straight



P 358.03
20 cm



P 358.04
22 cm



P 358.01
14 cm



P 358.02
17 cm



P 350.01
Eğri/Curved
17 cm



LISTON
P 359.02-P 359.04
Eğri/Curved



P 359.02
17 cm



P 359.03
20 cm



P 359.04
22 cm



BÖHLER
P 365.00
Düz/Straight
14.5 cm



BÖHLER
P 366.00
Eğri/Curved
14.5 cm

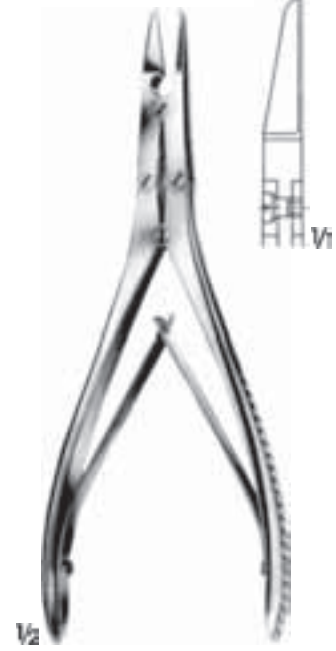

P 367.00
Eğri/Curved
17 cm



MC INDOE
P 368.00
Eğri/Curved
17.5 cm



RUSKIN - LISTON
P 370.00
Düz/Straight
19 cm



RUSKIN - LISTON
P 371.00
Eğri/Curved
19 cm

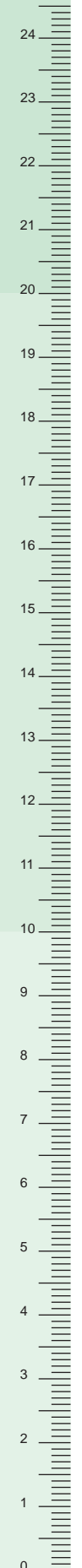



Vr



Vr



Vr



V2

LISTON
P 375.01
Eğri/Curved
24 cm



V2

LISTON
P 376.01
Düz/Straight
28 cm



V2

LISTON
P 377.01
Eğri/Curved
28 cm



LISTON - KEY - HORSLEY
P 379.01
S şekilli, arka kaburga uçları için
S-Shaped for posterior rib ends
25.5 cm



LISTON - STILLE
P 378.01
Açılı/Aggled
26.5 cm

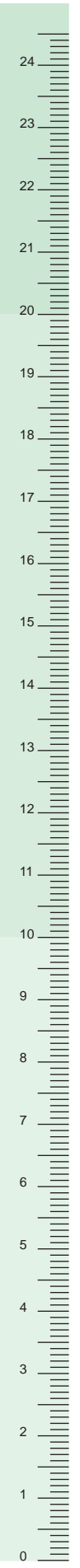



P 614.00
Tel Tutma Pensi, Düz burunlu
Wire Holding Forceps, Flat nosed
19 cm



P 615.00 - P 616.00
Tel çıkarma pensleri
Extraction pliers for boring wires



P 615.00
13 cm



P 616.00
18 cm



MARBURG MODELL
P 611.00
Tel Tutma Pensi,
Düz Burunlu, Tırtıllı Ağız
Wire Holding Forceps,
Flat nosed, With Serrated Jaws
14 cm

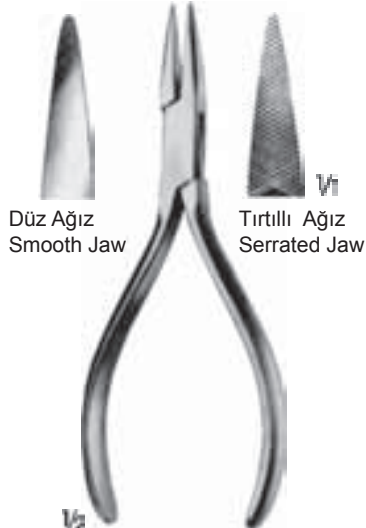

Düz Ağız
Smooth Jaw

Tırtıllı Ağız
Serrated Jaw

GOSLEE
P 617.00
Tel Tutma Pensi, Düz burunlu
Wire Holding Forceps, Flat nosed
14 cm



P 612.00 - P 613.00
Tel Bükücü, Düz burunlu
Wire twister, Flat nosed
17 cm



P 612.00
Tırtıllı Ağız
With serrated jaws



P 613.00
Boylamasına ve
Çapraz Kanallı
With Longitudinal and
Transversal Grooves

Elmas Kesici Ağız / With Carbide Cutting Edges



Yumuşak tel için Ø 1.5 mm
For soft wire Ø 1.5 mm
Sert tel için Ø 1.2 mm
For hard wire Ø 1.2 mm

P 632.00
Tel Kesme Pensi
Wire Cutting Pliers
14 cm



Kaymayı engellemek için yanıl çeneleri olan serklaj teli tutma pensi
Holding forceps for cerclage wire, with lateral jaws to avoid wire slipping off

P 610.00
17 cm



Yumuşak tel için Ø 0.9 mm
For soft wire Ø 0.9 mm

P 639.00
Sternum dikişinden sonra tel çıkartılması için açılı narin yapı
Angled slender pattern for wire removal after sternum suture
17 cm

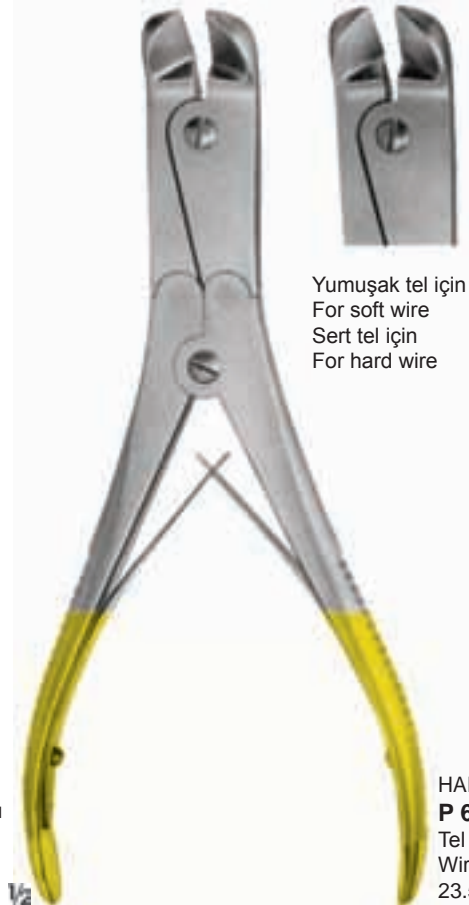

Yumuşak tel için Ø 3.0 mm
For soft wire Ø 3.0 mm
Sert tel için Ø 2.2 mm
For hard wire Ø 2.2 mm

HARVEY P 649.00
Tel Kesme Pensi
Wire Cutting Pliers
23.5 cm

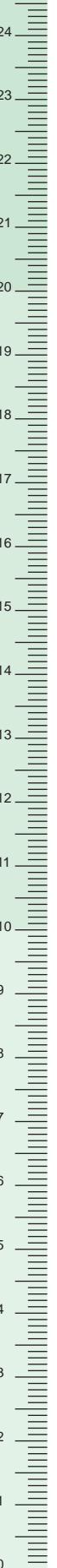

Elmas Kesici Ağız / With Carbide Cutting Edges



Yumuşak tel için Ø 2.0 mm
For soft wire Ø 2.0 mm
Sert tel için Ø 1.5 mm
For hard wire Ø 1.5 mm

REILL

P 640.00

Kemiğe Yakın Olan Telleri Kesme
For cutting off wires close to the bone
17.5 cm

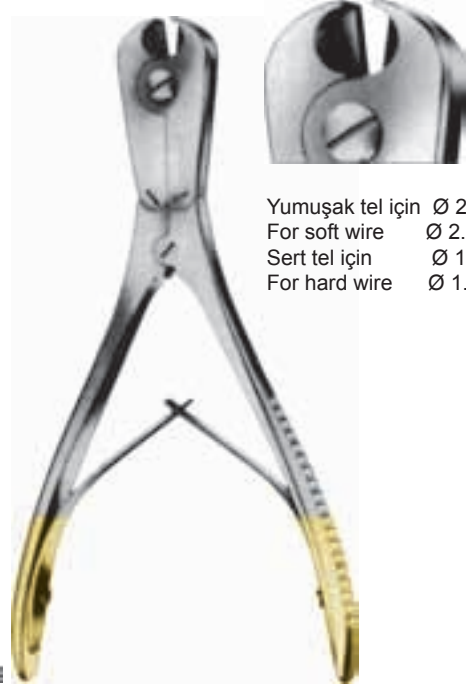

Yumuşak tel için Ø 2.0 mm
For soft wire Ø 2.0 mm
Sert tel için Ø 1.5 mm
For hard wire Ø 1.5 mm

P 641.00

Ön ve Yanal kesme
Front-and lateral cutting
18 cm



Yumuşak tel için Ø 3.0 mm
For soft wire Ø 3.0 mm
Sert tel için Ø 2.2 mm
For hard wire Ø 2.2 mm

P 643.00

Yanal Kesme
Lateral Cutting
23.5 cm



Yumuşak tel için Ø 2.5 mm
For soft wire Ø 2.5 mm
Sert tel için Ø 2.0 mm
For hard wire Ø 2.0 mm

P 645.00

Yanal Kesme
Lateral Cutting
24 cm

R 331.01



R 331.02



LUC
R 331.01 - R 331.02
20 cm

OLDBERG
R 410.00 Ø 7 mm

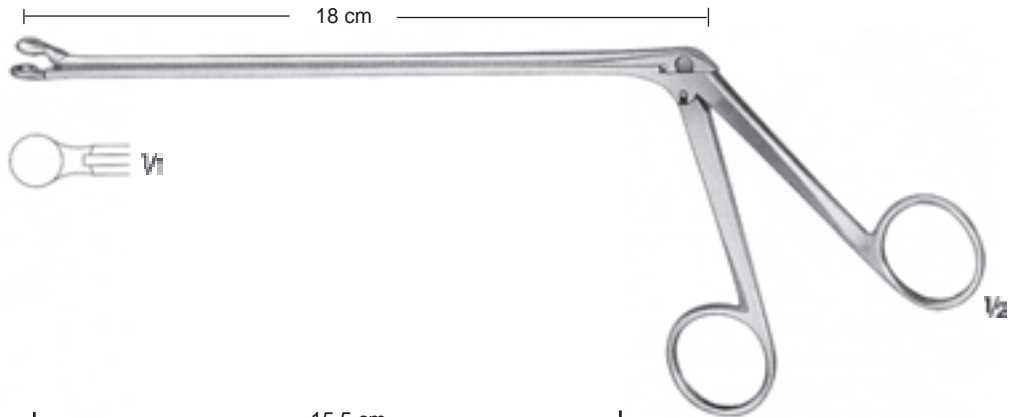

R 375.00 2 mm



R 375.01 3 mm



R 375.02 4 mm



R 375.03 5 mm



CASPAR
R 375.00 - R 375.03

CASPAR

R 379.00 2 mm



R 379.01 3 mm



R 379.02 4 mm



150°



CASPAR
R 379.00 - R 379.02

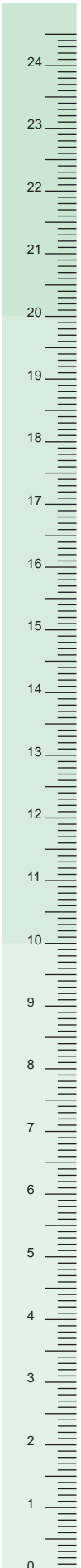

SETS

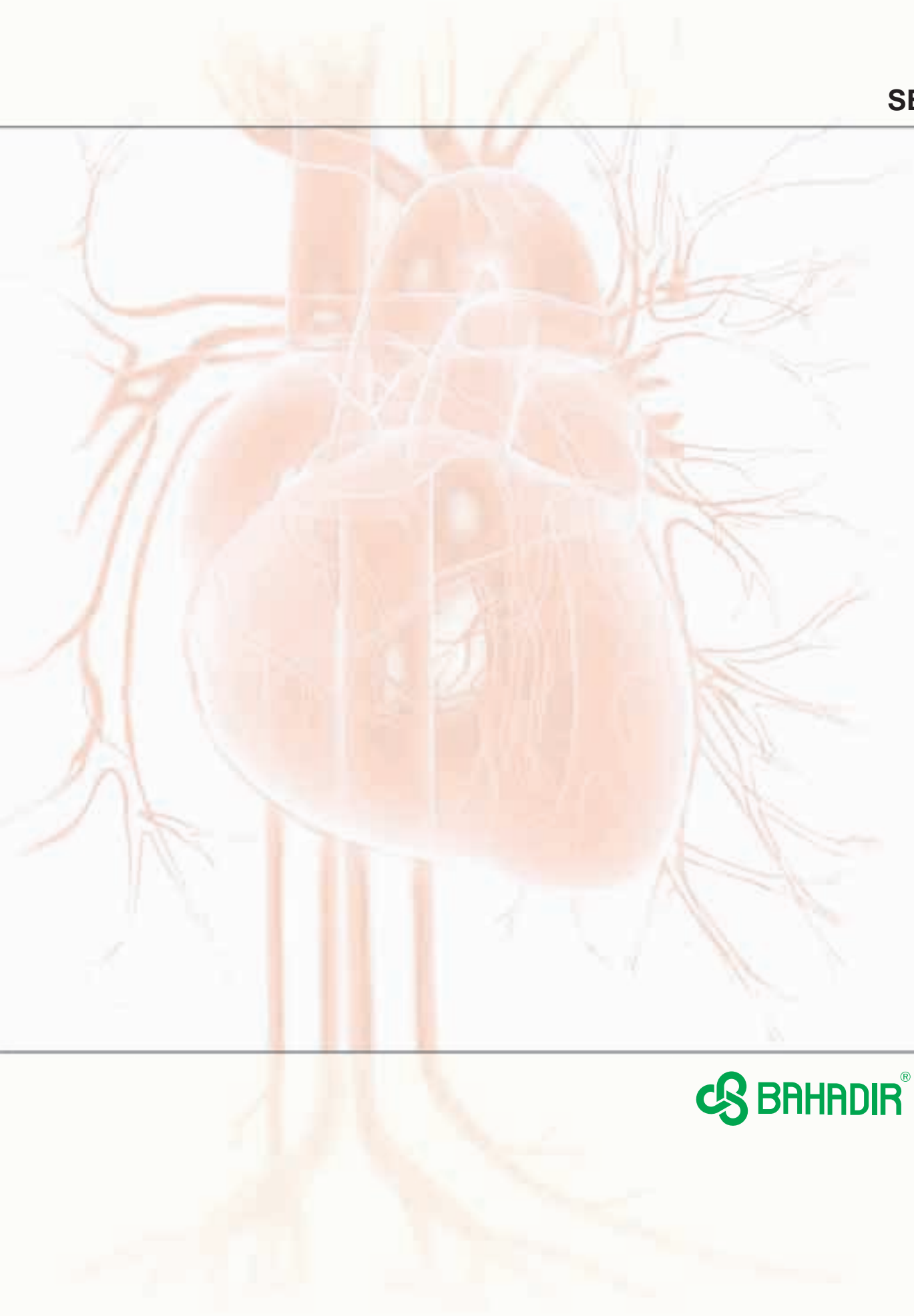

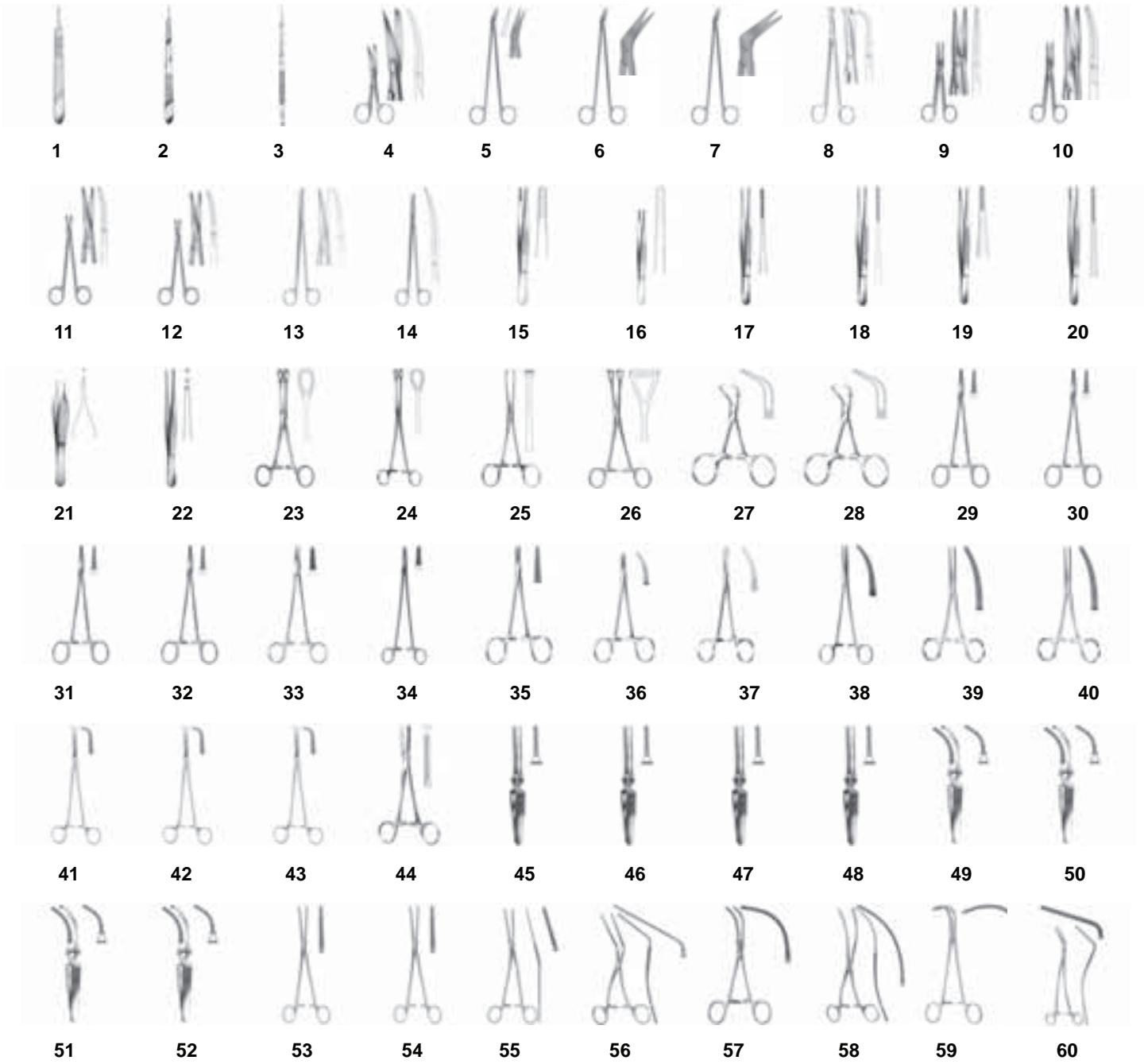

No	Quantity	Code	Description
1	1	B 030.01	Scalpel Handle 3 No 13.5 cm
2	1	B 030.02	Scalpel Handle 3 No 21.5 cm
3	1	B 032.00	Scalpel Handle 16.5 cm
4	1	C 311.03	Surgical Scissors Curved 14.5 cm
5	1	C 506.00	Potts-De Martel Vascular Scissors 30° 18.5 cm
6	2	C 506.01	Potts-De Martel Vascular Scissors 45° 18.5 cm
7	2	C 506.02	Potts-De Martel Vascular Scissors 60° 18.5 cm
8	1	C 569.00	Thorek Cardiovascular Surgery Scissors Curved 18 cm
9	1	C 725.01	Mayo Delicate Scissors HM Straight 17 cm
10	1	C 726.01	Mayo Delicate Scissors HM Curved 17 cm
11	1	C 756.00	Metzenbaum Dissecting Scissors HM Curved 14.5 cm
12	2	C 756.01	Metzenbaum Dissecting Scissors HM Curved 18 cm
13	1	C 761.00	Nelson-Metzenbaum Scissors HM Curved 23 cm
14	1	C 761.01	Nelson-Metzenbaum Scissors HM Curved 30 cm
15	2	D 240.03	Standart Dissecting Forcep Straight 16 cm
16	2	D 240.06	Standart Dissecting Forcep Straight 25 cm
17	2	D 262.01	De Bakey Forcep 2 mm 20 cm
18	2	D 262.02	De Bakey Forcep 2 mm 24 cm
19	2	D 263.01	De Bakey Forcep 2.7 mm 20 cm
20	2	D 263.02	De Bakey Forcep 2 mm 24 cm
21	3	D 323.00	Adson Micro Suture Tying Forcep 12 cm
22	2	D 360.04	Standart Forcep 16 cm
23	2	E 082.00	Foerster-Ballanger Tissue Grasping Forcep 18 cm
24	4	E 086.00	Foerster-Ballanger Tissue Grasping Forcep 24 cm
25	6	E 144.00	Allis Tissue Grasping Forcep 5x6 Teeth 15.5 cm
26	4	E 187.01	Collin Tissue Grasping Forcep 23 cm
27	24	E 430.00	Backhaus Towel Clamp 9 cm
28	10	E 430.02	Backhaus Towel Clamp 13.5 cm
29	2	F 346.00	De Bakey Needle Holder HM 0.4 18 cm
30	2	F 346.01	De Bakey Needle Holder HM 0.4 23 cm
31	2	F 346.02	De Bakey Needle Holder HM 0.4 25 cm
32	1	F 346.03	De Bakey Needle Holder HM 0.4 30.5 cm
33	4	F 355.01	Hegar Mayo Needle Holder 0.5 18 cm
34	2	F 357.01	Hegar Needle Holder 0.5 24.5 cm
35	6	G 214.00	Halsted Masquito Delicate Haemostatic Forcep Straight 12.5 cm
36	12	G 215.00	Halsted Masquito Delicate Haemostatic Forcep Curved 12.5 cm
37	18	G 251.00	Leriche Delicate Haemostatic Forcep Curved 14 cm
38	6	G 301.00	Heiss Delicate Haemostatic Forcep Curved 20 cm
39	12	G 431.00	Rochester-Pean Haemostatic Forcep Curved 16 cm
40	4	G 431.03	Rochester-Pean Haemostatic Forcep Curved 22.5 cm
41	1	G 644.02	Gemini Dissecting and Ligature Forcep 18 cm
42	1	G 644.04	Gemini Dissecting and Ligature Forcep 23 cm
43	1	G 644.06	Gemini Dissecting and Ligature Forcep 28 cm
44	6	G 884.02	Tubing Clamp Forceps 20 cm
45	2	H 120.00	De Bakey Bulldog Clamp Straight 8 cm
46	2	H 120.01	De Bakey Bulldog Clamp Straight 9 cm
47	2	H 120.02	De Bakey Bulldog Clamp Straight 10.5 cm
48	2	H 120.03	De Bakey Bulldog Clamp Straight 12.5 cm
49	2	H 121.00	De Bakey Bulldog Clamp Curved 7.5 cm
50	2	H 121.01	De Bakey Bulldog Clamp Curved 8.5 cm
51	2	H 121.02	De Bakey Bulldog Clamp Curved 9.5 cm
52	2	H 121.03	De Bakey Bulldog Clamp Curved 11.5 cm
53	2	H 420.00	De Bakey Coarctation Clamp Straight 41 mm 20.5 cm
54	4	H 420.01	De Bakey Coarctation Clamp Straight 65 mm 22.5 cm
55	2	H 421.00	De Bakey Coarctation Clamp Angled 15° 41 mm 20.5 cm
56	6	H 433.00	De Bakey Peripheral Vascular Clamp 60° 77x65 mm 18 cm
57	2	H 450.00	De Bakey Peripheral Vascular Clamp 56 mm 16 cm
58	2	H 451.01	De Bakey Peripheral Vascular Clamp 92.5 mm 20 cm
59	2	H 452.00	Glover Anastomosis Clamp 70 mm 19.5 cm
60	2	H 461.00	De Bakey(Morris Modif.) Angled 70° 70 mm 24 cm

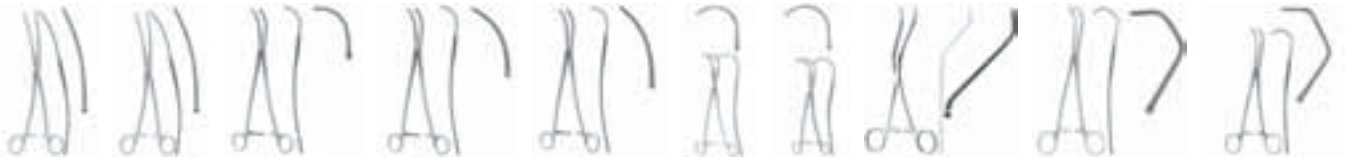

61 62 63 64 65 66 67 68 69 70

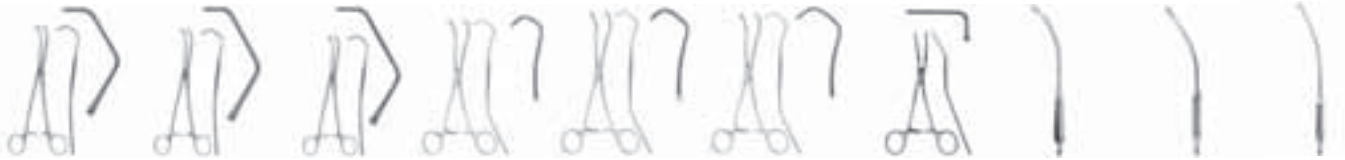

71 72 73 74 75 76 77 78 79 80



81 82 83 84 85 86 87 88 89 90



91 92 93 94 95 96 97 98 99 100



101 102 103 104 105 106 107 108 109 110



111 112 113 114 115 116 117 118 119



120



121

No	Quantity	Code	Description
61	2	H 465.01	De Bakey Aorta Aneurysm Clamp 2x3 teeth 110 mm 30 cm
62	2	H 465.02	De Bakey Aorta Aneurysm Clamp 2x3 teeth 130 mm 31.5 cm
63	1	H 477.00	De Bakey Aorta Aneurysm Clamp 70 mm 25.5 cm
64	1	H 477.01	De Bakey Aorta Aneurysm Clamp 75 mm 26.5 cm
65	1	H 477.02	De Bakey Aorta Aneurysm Clamp 85 mm 28 cm
66	1	H 480.00	De Bakey(Semb Modif.) Aorta Aneurysm Clamp 100 mm 26.5 cm
67	2	H 481.00	De Bakey Aorta Aneurysm Clamp 111 mm 27 cm
68	2	H 563.00	Henly Anastomosis Clamp 88 mm 19.5 cm
69	1	H 570.00	De Bakey Tangential Occlusion Clamp 38x85 mm 22 cm
70	1	H 570.01	De Bakey Tangential Occlusion Clamp 48x95 mm 26.5 cm
71	1	H 570.02	De Bakey Tangential Occlusion Clamp 54x99 mm 27 cm
72	1	H 570.03	De Bakey Tangential Occlusion Clamp 58x103 mm 27 cm
73	1	H 570.04	De Bakey Tangential Occlusion Clamp 75x119 mm 27 cm
74	1	H 630.00	Derra-Cooley Anastomosis Clamp 16x71 mm 17 cm
75	1	H 630.01	Derra-Cooley Anastomosis Clamp 21x76 mm 17.5 cm
76	1	H 630.02	Derra-Cooley Anastomosis Clamp 27x80 mm 17.5 cm
77	3	H 640.00	Cooley Multi Purpose Clamp Angled 30° 35x48 mm 15 cm
78	1	J 301.00	Yankauer Cannulae Ø10 mm 28.5 cm
79	1	J 302.00	Cooley Cannulae Ø8 mm 31 cm
80	1	J 303.00	Cooley Cannulae Ø8 mm 36 cm
81	1	J 510.02	De Bakey Dilator Malleable Ø 0.5 mm 19 cm
82	1	J 510.03	De Bakey Dilator Malleable Ø 1.0 mm 19 cm
83	1	J 510.04	De Bakey Dilator Malleable Ø 1.5 mm 19 cm
84	1	J 510.05	De Bakey Dilator Malleable Ø 2.0 mm 19 cm
85	1	J 510.06	De Bakey Dilator Malleable Ø 2.5 mm 19 cm
86	1	J 510.07	De Bakey Dilator Malleable Ø 3.0 mm 19 cm
87	1	J 510.08	De Bakey Dilator Malleable Ø 3.5 mm 19 cm
88	1	J 510.09	De Bakey Dilator Malleable Ø 4.0 mm 19 cm
89	1	J 510.10	De Bakey Dilator Malleable Ø 4.5 mm 19 cm
90	1	J 510.11	De Bakey Dilator Malleable Ø 5.0 mm 19 cm
91	1	J 510.12	De Bakey Dilator Malleable Ø 7.0 mm 19 cm
92	1	J 510.13	De Bakey Dilator Malleable Ø 9.0 mm 19 cm
93	1	J 510.14	De Bakey Dilator Malleable Ø 6.0 mm 19 cm
94	1	J 510.15	De Bakey Dilator Malleable Ø 8.0 mm 19 cm
95	1	J 510.17	De Bakey Dilator Malleable Ø 10.0 mm 19 cm
96	2	J 530.01	Rumel-Belmont Tourniquets Ø 4.0 mm 32.5 cm
97	2	J 530.06	Rumel-Belmont Mandrin allein guide only
98	1	K 273.02	Marberger Retractor 8 mm 24 cm
99	1	K 273.03	Marberger Retractor 12 mm 24 cm
100	2	K 432.03	Volkman Retractor Sharp 9x29 mm 22 cm
101	1	K 451.02	Langenbeck Retractor 28x14 mm 21 cm
102	1	K 451.03	Langenbeck Retractor 33x14 mm 21 cm
103	2	K 451.04	Langenbeck Retractor 28x16 mm 21 cm
104	1	K 605.06	Kocher Retractor 80x60 mm 25 cm
105	1	K 608.01	Kocher -Wagner Retractor 36x20 mm 28 cm
106	1	K 608.02	Kocher -Wagner Retractor 64x25 mm 28 cm
107	1	K 660.04	Deaver Retractor 25 mm 30 cm
108	2	K 668.07	Deaver Retractor 50 mm 30.5 cm
109	1	K 695.02	Cooley Retractor Slightly Serrated 45x48 mm 26.5 cm
110	1	K 697.02	Cooley Retractor Left 25x46 mm 28 cm
111	2	L 304.00	Weitlaner Self-Retaining Retractor Sharp 13 cm
112	2	L 312.00	Weitlaner Self-Retaining Retractor Sharp 16.5 cm
113	1	L 828.02	Cooley Rib Spreader 14x14.5x20 cm Blade 21x45 mm
114	1	L 828.04	Cooley Rib Spreader 18x19x29 cm Blade 32x50 mm
115	1	L 865.05	Mimimally Invasive Retractor 20.5x23 cm
116	1	R 375.01	Caspar Rongeur 3 mm 15.5 cm
117	1	R 379.01	Caspar Rongeur 150° 3 mm 15.5 cm
118	1	R 860.01	Tubbs Aortic Dilator Blade opening 8-42 mm
119	1	T 852.00	Bailey Rib Spreader 20 cm
120	2	Y 190.07	Wire Basket, 485x255x70 mm
121	1	Y 111.20	1/1 Size Container, 580x280x200 mm

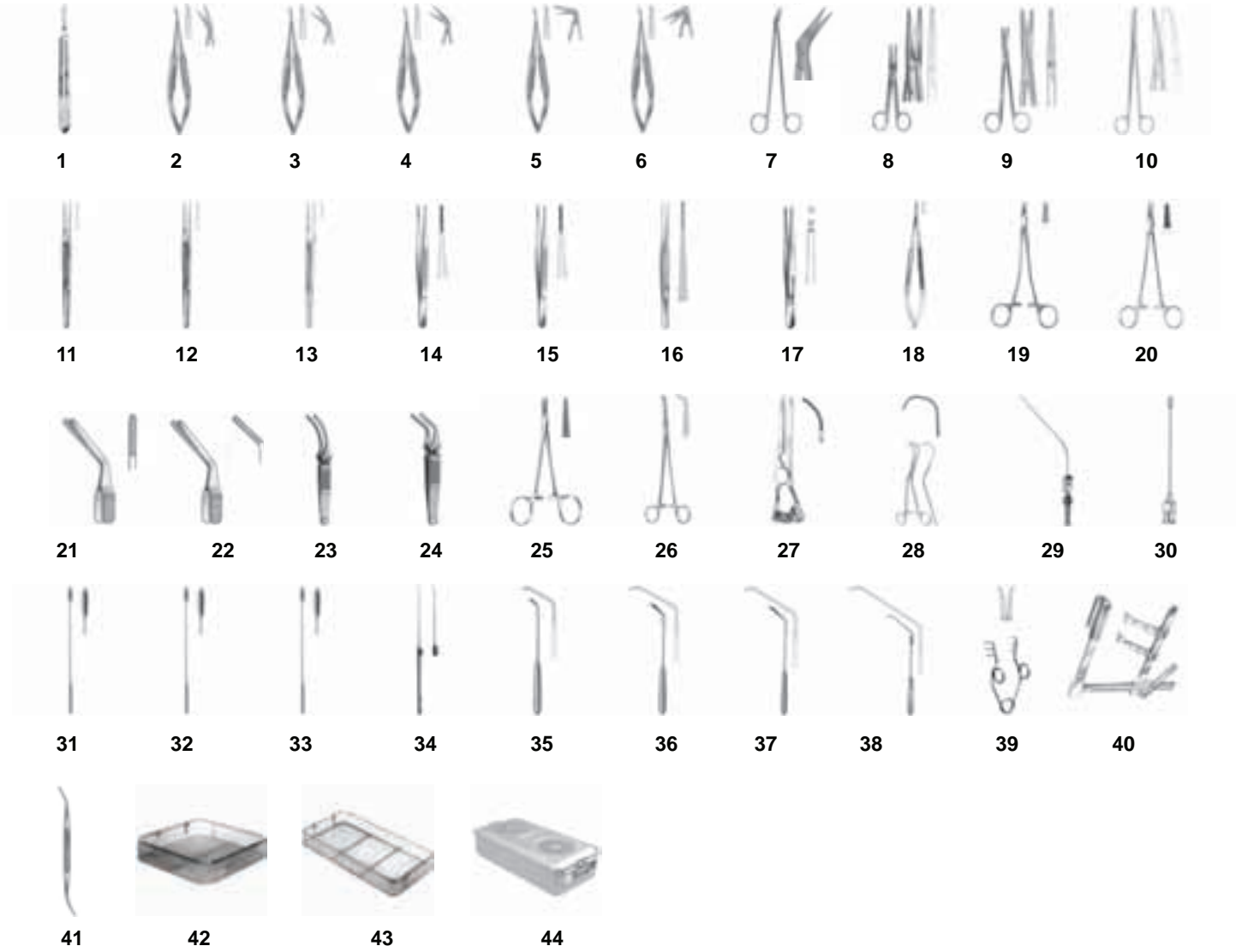

No	Quantity	Code	Description
1	1	B 040.01	Scalpel Handle 4 No 13.5 cm
2	1	C 135.00	Vascular Scissors 25° 18.5 cm
3	1	C 135.01	Vascular Scissors 45° 18.5 cm
4	1	C 135.03	Vascular Scissors 60° 18.5 cm
5	1	C 135.04	Vascular Scissors 90° 18.5 cm
6	1	C 135.06	Vascular Scissors 125° 18.5 cm
7	1	C 506.01	Potts-De Martel Vascular Scissors 45° 18.5 cm
8	1	C 725.01	Mayo Delicate Scissors Straight 17 cm
9	1	C 755.00	Metzenbaum Dissecting Scissors Straight 14.5 cm
10	1	C 761.00	Nelson-Metzenbaum(Mc Indore) Scissors Curved 23 cm
11	1	D 601.03	Micro Tissue Forcep Ø 0.5x1.0 mm 18 cm
12	1	D 602.03	Micro Tissue Forcep Ø 1.3x2.0 mm 18 cm
13	1	D 186.07	Micro Tissue Forcep Ø 0.8x6.0 mm 21 cm
14	1	D 265.00	De Bakey Forcep 1.5 mm 15 cm
15	1	D 265.01	De Bakey Forcep 1.5 mm 20 cm
16	1	D 265.02	De Bakey Forcep 1.5 mm 24 cm
17	1	D 370.02	Tissue Forcep 16 cm
18	1	F 156.23	Micro Needle Holder With catch 0.8x11 mm 20.5 cm
19	1	F 338.00	Sarot Needle Holder 17.5 cm
20	1	F 355.00	Hegar-Mayo Needle Holder 15 cm
21	2	G 037.01	Featherlight Bulldog Clamp 14 mm 3.5 cm
22	2	G 038.01	Featherlight Bulldog Clamp 14 mm 3.3 cm
23	2	H 106.00	De Bakey Bulldog Clamp Curved 5.5 cm
24	2	H 107.00	De Bakey Bulldog Clamp Angled 55° 5 cm
25	10	G 214.00	Halsted Masquito Delicate Haemostatic Forcep Straight 12.5 cm
26	1	G 642.00	Mini-Gemini Dissecting Forcep 18 cm
27	2	H 137.00	De Bakey Bulldog Clamp Length of jaws 2.7 mm 4.8 cm
28	1	H 486.00	Lambert-Kay Aorta Anastomosis Clamp 40x93 mm 21.5 cm
29	2	J 214.01	Fergusson Suction Tube Ø 2.5 mm 18 cm
30	3	J 307.01	Heparin Cannulae Ø 3 mm 4.5 cm
31	1	J 510.03	De Bakey Dilator Malleable Ø 1 mm 19 cm
32	1	J 510.05	De Bakey Dilator Malleable Ø 2 mm 19 cm
33	1	J 510.06	De Bakey Dilator Malleable Ø 2.5 mm 19 cm
34	1	K 110.00	Krayenbühl Vessel Hook 18.5 cm
35	1	K 616.00	Zenker Retractor 36x8 mm 24 cm
36	1	K 616.02	Zenker Retractor 60x12 mm 25.5 cm
37	1	K 616.04	Zenker Retractor 75x12 mm 27 cm
38	1	K 616.06	Zenker Retractor 120x12 mm 29 cm
39	2	L 005.01	Self-Retaining Retractor 5.5 cm
40	1	L 869.00	Rib Spreader Retractor System Complete
41	1	M 158.01	Watson-Cheyne Dissector 18 cm
42	1	Y 390.03	Wire Basket, 255x245x30 mm
43	1	Y 190.07	Wire Basket, 485x255x70 mm
44	1	Y 110.13	1/1 Size Container, 580x280x135 mm

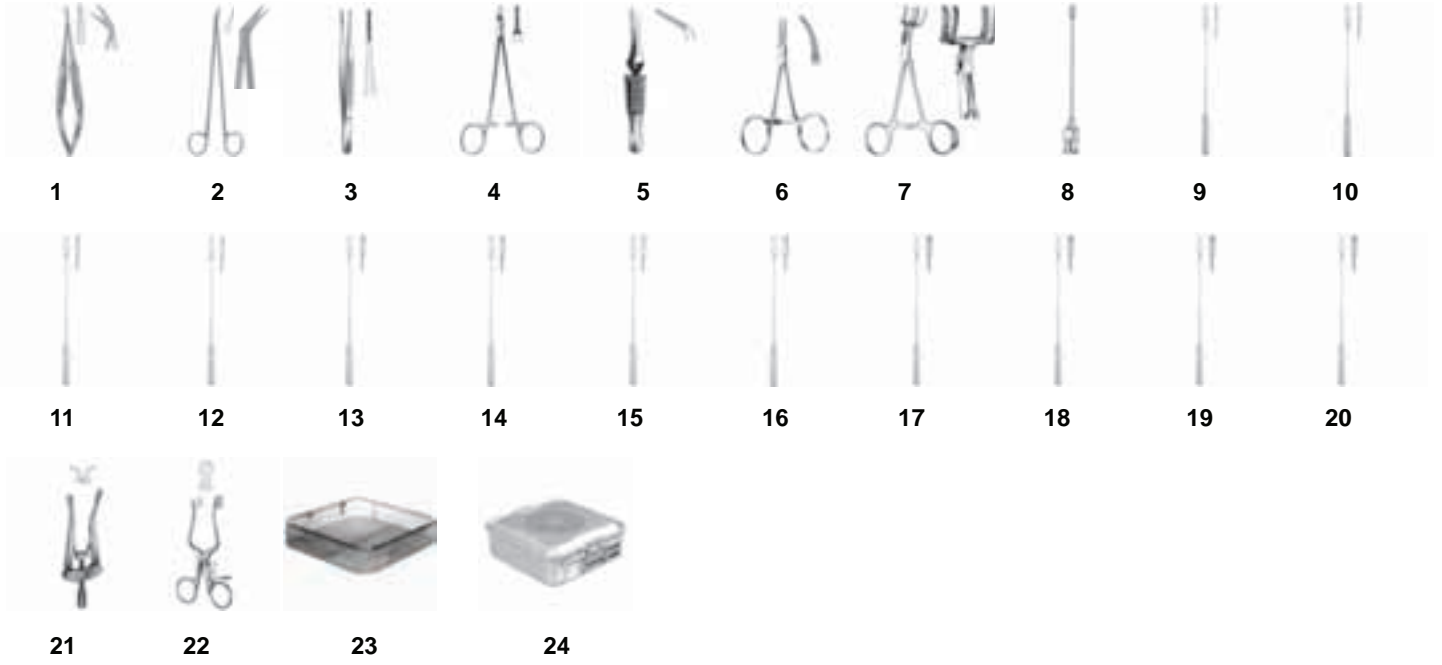

No	Quantity	Code	Description
1	1	C 135.01	Vascular Scissors 45° 18.5 cm
2	1	C 504.01	Diethrich-Hegemann Vascular Scissors 45° 18 cm
3	1	D 265.00	De Bakey Forcep 1.5 mm 15 cm
4	1	F 380.01	Ryder Needle Holder 15.5 cm
5	4	G 011.01	Diethrich Bulldog Clemp 4.5 cm
6	6	G 201.00	Baby-Mosquito Delicate Haemostatic Forcep Curved 10 cm
7	1	H 559.00	Anastomosis Clamp 13 cm
8	2	J 307.01	Heparin Cannulae Ø 3.0 mm 4.5 cm
9	1	J 513.00	De Bakey Dilator Ø 0.5 mm 14 cm
10	1	J 513.01	De Bakey Dilator Ø 1 mm 14 cm
11	1	J 513.02	De Bakey Dilator Ø 1.5 mm 14 cm
12	1	J 513.03	De Bakey Dilator Ø 2 mm 14 cm
13	1	J 513.04	De Bakey Dilator Ø 2.5 mm 14 cm
14	1	J 513.05	De Bakey Dilator Ø 3 mm 14 cm
15	1	J 513.06	De Bakey Dilator Ø 3.5 mm 14 cm
16	1	J 513.07	De Bakey Dilator Ø 4 mm 14 cm
17	1	J 513.08	De Bakey Dilator Ø 4.5 mm 14 cm
18	1	J 513.09	De Bakey Dilator Ø 5 mm 14 cm
19	1	J 513.11	De Bakey Dilator Ø 7 mm 14 cm
20	1	J 513.13	De Bakey Dilator Ø 9 mm 14 cm
21	2	L 088.00	Alm Self-Retaining Retractor Blunt 7 cm
22	1	L 301.00	Weitlaner Self-Retaining Retractor Blunt 11 cm
23	1	Y 390.05	Wire Basket, 255x245x50 mm
24	1	Y 310.10	1/2 Size Container, 285x280x100 mm



1

2

3

4

5

6

7

8

9

10



11



12



13



14

No	Quantity	Code	Description
1	1	F 355.00	Hegar-Mayo Needle Holder 15 cm
2	1	F 380.02	Ryder Needle Holder 17.5 cm
3	1	F 381.01	Ryder Needle Holder 17.5 cm
4	15	G 214.00	Halsted Masquito Delicate Haemostatic Forcep Straight 12.5 cm
5	1	K 647.00	Ross Retractor 16x15 mm 24 cm
6	1	K 647.01	Ross Retractor 23x13 mm 24 cm
7	1	K 647.02	Ross Retractor 24x16 mm 24 cm
8	1	K 647.03	Ross Retractor 27x13 mm 24 cm
9	1	K 647.04	Ross Retractor 27x27 mm 24 cm
10	1	K 647.05	Ross Retractor 25x39 mm 24 cm
11	1	R 331.01	Luc Rongeur 20 cm
12	1	R 410.00	Oldberg Rongeur Ø 7 mm 18 cm
13	1	Y 390.05	Wire Basket, 255x245x50 mm
14	1	Y 310.10	1/2 Size Container, 285x280x100 mm



1 2 3 4 5 6 7 8 9 10



11 12 13 14 15 16 17 18 19 20



21 22 23 24 25 26 27 28 29 30



31



32

No	Quantity	Code	Description
1	1	F 334.00	Needle Holder 15 cm
2	6	G 884.02	Tubing Clamp Forceps 20 cm
3	2	J 304.00	De Bakey Cannulae Ø9 mm 27.5 cm
4	1	K 325.02	Roux Retractor 25x26-28x38 mm 16.5 cm
5	1	K 325.03	Roux Retractor 28x29-33x45 mm 16.5 cm
6	1	K 404.00	Volkman Retractor Sharp 22 cm
7	1	K 406.00	Volkman Retractor Sharp 20 cm
8	2	K 432.02	Volkman Retractor Sharp 9x19 mm 22 cm
9	2	K 432.03	Volkman Retractor Sharp 9x29 mm 22 cm
10	1	K 605.04	Kocher Retractor 80x42 mm 25 cm
11	2	K 608.01	Kocher -Wagner Retractor 36x20 mm 28 cm
12	1	K 616.00	Zenker Retractor 36x8 mm 24 cm
13	1	K 616.02	Zenker Retractor 60x12 mm 25.5 cm
14	2	K 616.04	Zenker Retractor 75x12 mm 27 cm
15	1	K 616.06	Zenker Retractor 120x12 mm 29 cm
16	2	K 697.02	Cooley Retractor Left 25x46 mm 28 cm
17	1	L 304.00	Weitlaner Self-Retaining Retractor Sharp 13 cm
18	1	L 354.02	Weitlaner Self-Retaining Retractor Blunt 24 cm
19	1	L 808.00	Finochietto Rib Spreader 14x17x20 cm Blade 36x45 mm
20	1	M 278.03	Lambotte Raspatories 15 mm 21.5 cm
21	1	M 289.05	Semb Raspatories 15 mm 23 cm
22	1	N 176.04	Schede Bone Curette 5.2 mm 17 cm
23	1	N 179.06	Wolkman Bone Curette 8.5 mm 17 cm
24	1	N 179.07	Wolkman Bone Curette 10 mm 17 cm
25	1	P 321.01	Luer-Stille Bone Rongeur 22.5 cm
26	1	P 370.00	Ruskin-Liston Bone Cutting Forcep 19 cm
27	1	P 502.01	Giertz-Stille Rib Scissors 25 cm
28	1	P 612.00	Wire Holding Forcep 17 cl
29	1	P 640.00	Reill Wire Cutting Forcep HM 17.5 cm
30	1	T 852.00	Bailey Rib Spreader 20 cm
31	1	Y 290.07	Wire Basket, 405x255x70 mm
32	1	Y 210.10	3/4 Size Container, 465x280x100 mm

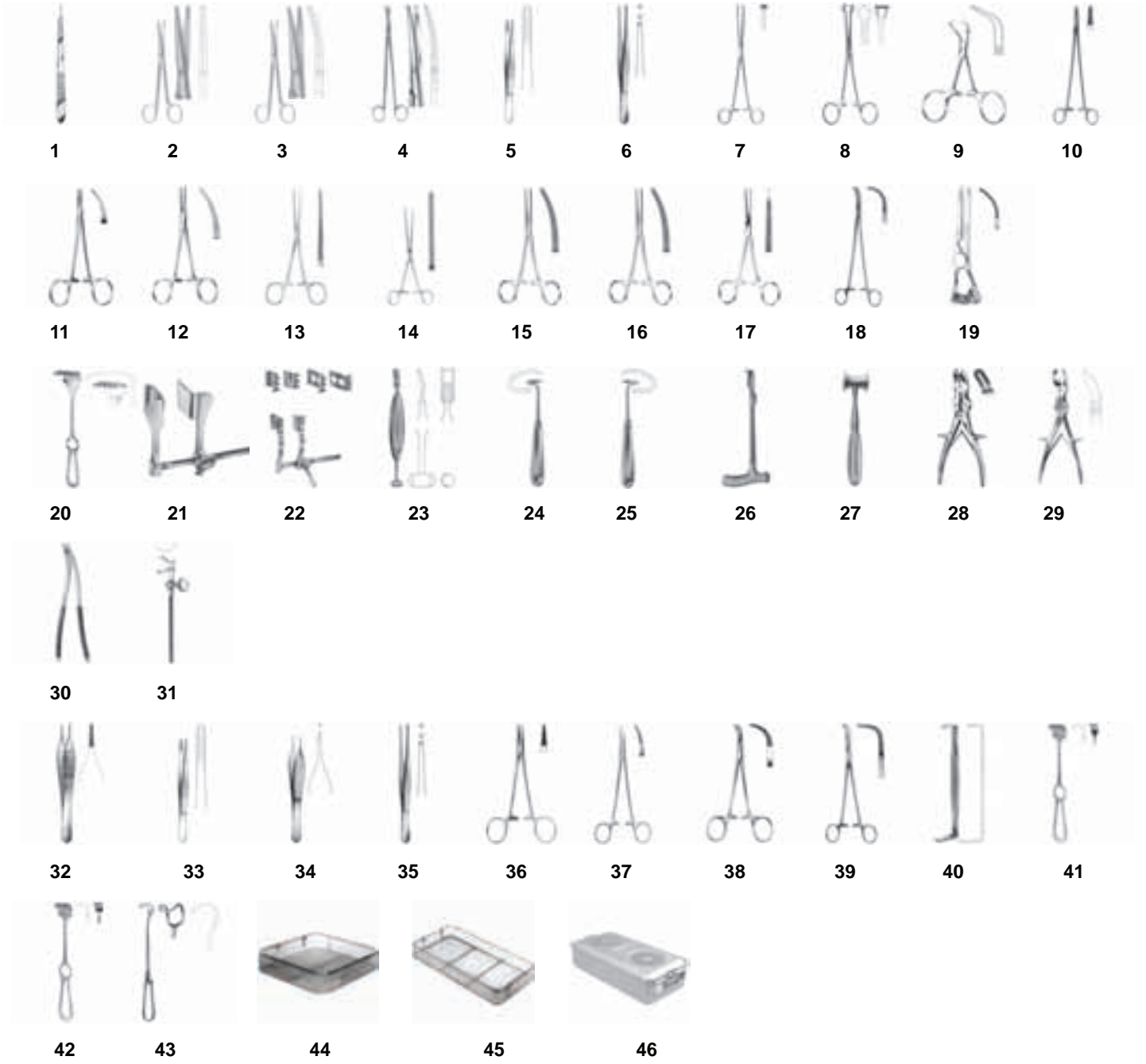

No	Quantity	Code	Description
----	----------	------	-------------

For abdominal and chest incision, Major Basic Instrument Set, Plus the Following

1	1	B 030.02	Scalpel Handle 3 no, 21.5 cm
2	1	C 458.01	Mayo Surgical Scissors, Straight, 20 cm
3	1	C 459.01	Mayo Surgical Scissors, Curved, 20 cm
4	1	C 768.01	Nelson-Metzenbaum Dissecting Scissors, HM, Curved, 28 cm
5	2	D 240.05	Standart Dissecting Forcep, 20 cm
6	2	D 360.06	Standart Tissue Forcep, 20 cm
7	6	E 147.01	Allis Tissue Grasping Forcep, 5x6 teeth, 19 cm
8	6	E 174.01	Babcock Organ and Tissue Grasping Forcep, 21.5 cm
9	12	E 430.00	Backhaus Towel Clamp, 9 cm
10	2	F 357.01	Hegar Needle Holder, HM, 24.5 cm
11	12	G 207.00	Micro-Halsted Delicate Haemostatic Forcep, Curved, 12.5 cm
12	12	G 241.00	Crile Delicate Haemostatic Forcep, Curved, 14 cm
13	2	G 330.00	Allen Intestinal Clamp, Straight, 15.5 cm
14	2	G 370.07	Kocher Intestinal Clamp, Elastic, Straight, 28 cm
15	12	G 431.00	Rochester-Pean Haemostatic Forcep, Curved, 16 cm
16	6	G 431.02	Rochester-Pean Haemostatic Forcep, Curved, 20 cm
17	6	G 448.02	Kocher-Ochsner Haemostatic Forcep, Straight, 1x2 teeth 20 cm
18	6	G 654.00	Mixer Ligature Forcep, Curved, 23 cm
19	4	H 137.02	Glomer Bulldog Clamp, Curved, 8 cm

Plus chest Onstrument as follows

20	2	K 444.01	Israel Retractor, Blunt, 47 x 51 mm, 25.5 cm
21	1	L 804.00	Tuffier Rib Spreader 12.5x13x17 mm, Bleyd 43x53 mm
22	1	L 812.00	Finochietto Rib Spreader, 22x21x26 cm, Blade 65 x 65 mm
23	1	M 285.00	Alexander Raspatorie, 12 mm, 21 cm
24	1	M 290.01	Doyen Raspatorie, 17.5 cm
25	1	M 291.01	Doyen Raspatorie, 17.5 cm
26	1	M 598.00	Lebsche Sternum Cutter, 20 cm
27	1	M 808.01	Hibbs Mallet, 340gr, 20 cm
28	1	P 321.01	Luer-Stille Bone Rongeurs 22.5 cm
29	1	P 377.01	Liston Bone Cutting Forcep, 28 cm
30	1	P 515.00	Bethune Rib Shear, 34 cm
31	1	T 852.00	Bailey Rib Spreader, 20 cm

For anstomosis of cervical end of esophagus, Minor Basic instrument Set, plus the following

32	1	D 205.00	Micro Adson Delicate Dissecting Forcep, 12 cm
33	1	D 240.05	Standart Dissecting Forcep, 20 cm
34	1	D 323.00	Adson Delicate Tissue Forcep, 12 cm
35	1	D 360.06	Standart Tissue Forcep, 20 cm
36	2	F 328.00	Baby-Crile-wood Needle Holder, HM, 15 cm
37	4	G 460.00	Schnidt Haemostatic Forcep, 18.5 cm
38	2	G 616.01	Baby-Mixer Ligature Forcep, Curved, 18 cm
39	2	G 674.01	Mixer Dissecting Forcep, 25 cm
40	1	K 342.00	Us.Army Retractor, 22 cm
41	2	K 432.01	Volkman Retractor, Sharp, 9x13 mm, 22 cm
42	2	K 433.01	Vollkman Retractor, Blunt, 8x13 mm. 22 cm
43	2	K 481.00	Greene Retractor, 28 x 20 mm 22.5 cm
44	1	Y 390.03	Wire Basket, 255x245x30 mm
45	1	Y 190.07	Wire Basket, 485x255x70 mm
46	1	Y 110.13	1/1 Size Container, 580x280x135 mm

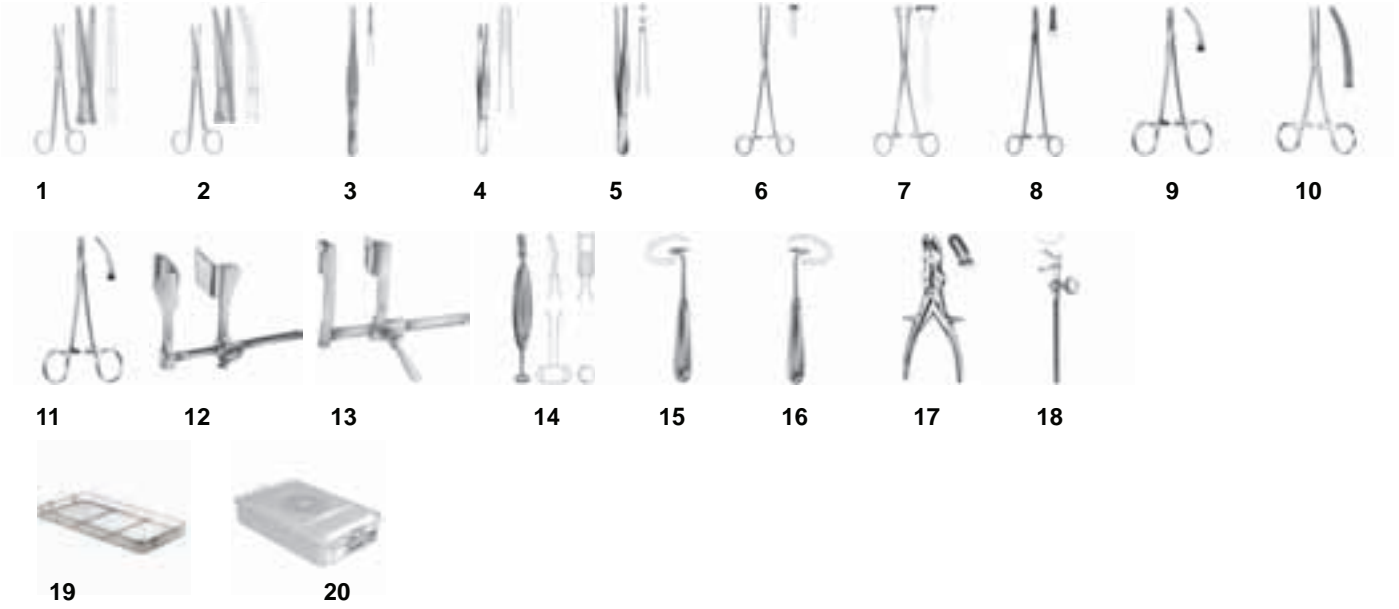

No	Quantity	Code	Description
1	1	C 458.01	Mayo Surgical Scissors, Straight, 20 cm
2	1	C 459.01	Mayo Surgical Scissors, Curved, 20 cm
3	1	D 220.02	Cushing Dissecting Forcep, Straight, 25 cm
4	1	D 240.05	Standart Dissecting Forcep, 20 cm
5	1	D 360.06	Standart Tissue Forcep, 20 cm
6	6	E 147.01	Allis Tissue Grasping Forcep, 5x6 teeth, 19 cm
7	2	E 171.02	Babcock Tissue Grasping Forcep, 22 cm
8	2	F 357.01	Hegar Needle Holder, HM, 24.5 cm
9	18	G 207.00	Micro-Halsted Delicate Haemostatic Forcep, Curved, 12.5 cm
10	12	G 431.00	Rochester-Pean Haemostatic Forcep, Curved, 16 cm
11	6	G 654.00	Mixer Ligature Forcep, Curved, 23 cm
12	2	L 804.00	Tuffier Rib Spreader 12.5x13x17 mm, Bleyd 43x53 mm
13	1	L 810.00	Finochietto Rib Spreader, 20x21x26 cm, Blade 44 x 65 mm
14	1	M 285.00	Alexander Raspatorie, 12 mm, 21 cm
15	1	M 290.01	Doyen Raspatorie, 17.5 cm
16	1	M 291.01	Doyen Raspatorie, 17.5 cm
17	1	P 321.01	Luer-Stille Bone Rongeurs 22.5 cm
18	1	T 852.00	Bailey Rib Spreader, 20 cm
19	1	Y 290.07	Wire Basket, 405x255x70 mm
20	1	Y 210.10	3/4 Size Container, 465x280x100 mm



1 2 3 4 5 6 7 8 9 10



11 12 13 14 15 16 17 18 19 20



21 22 23 24 25 26 27

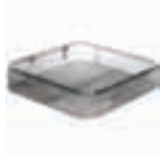

28



29



30

No	Quantity	Code	Description
1	1	C 134.03	Vascular Scissors 60° 18.5 cm
2	1	C 134.06	Vascular Scissors 125° 18.5 cm
3	1	C 756.00	Metzenbaum Dissecting Scissors 14.5 cm
4	1	C 758.00	Toennis-Adson Dissecting Scissors 17.5 cm
5	1	D 162.21	Forcep Ø1.3x2.0 mm 18 cm
6	1	D 257.01	De Bakey Forcep 1 mm 18 cm
7	1	D 265.01	De Bakey Forcep 1.5 mm 20 cm
8	1	D 267.00	De Bakey Forcep 1 mm 15 cm
9	1	F 156.23	Micro Needle Holder With catch 0.8x11 mm 20.5 cm
10	1	F 380.01	Ryder Needle Holder H.M. 15.5 cm
11	1	G 614.00	Micro Adson Dissecting Forcep 14 cm
12	1	G 617.00	Baby-Adson Dissecting Forcep 14 cm
13	1	H 522.00	De Bakey Bulldog Clamp 53 mm 12.5 cm
14	2	H 530.00	Castaneda Anastomosis Clamp 48 mm 12.5 cm
15	1	H 531.00	Castaneda Anastomosis Clamp 48 mm 30° 12 cm
16	1	H 532.00	Castaneda Anastomosis Clamp 48 mm 45° 12 cm
17	1	H 540.00	Castaneda Multi Purpose Clamp 15x48 mm 15.5 cm
18	2	H 540.01	Castaneda Multi Purpose Clamp 18x52 mm 15.5 cm
19	1	K 109.00	Zenker Vessel Hook 3x10 mm 18.5cm
20	1	K 135.00	Pbi Vessel Hook 90° 19 cm
21	1	K 141.00	Pbi Vessel Hook 90° 19 cm
22	1	K 152.00	Vessel Hook 8x12 mm 17.5 cm
23	1	K 153.00	Vessel Hook 12x5 mm 17.5 cm
24	1	L 881.00	Castaneda Aluminium Rib Spreader 6.5 cm
25	1	L 881.01	Castaneda Aluminium Rib Spreader 7 cm
26	1	L 881.04	Castaneda Aluminium Rib Spreader 12 cm
27	1	R 861.01	Cooley Aortic Dilator Blade opening 8-15 mm
28	1	Y 390.03	Wire Basket, 255x245x30 mm
29	1	Y 290.05	Wire Basket, 405x255x50 mm
30	1	Y 210.10	3/4 Size Container, 465x280x100 mm

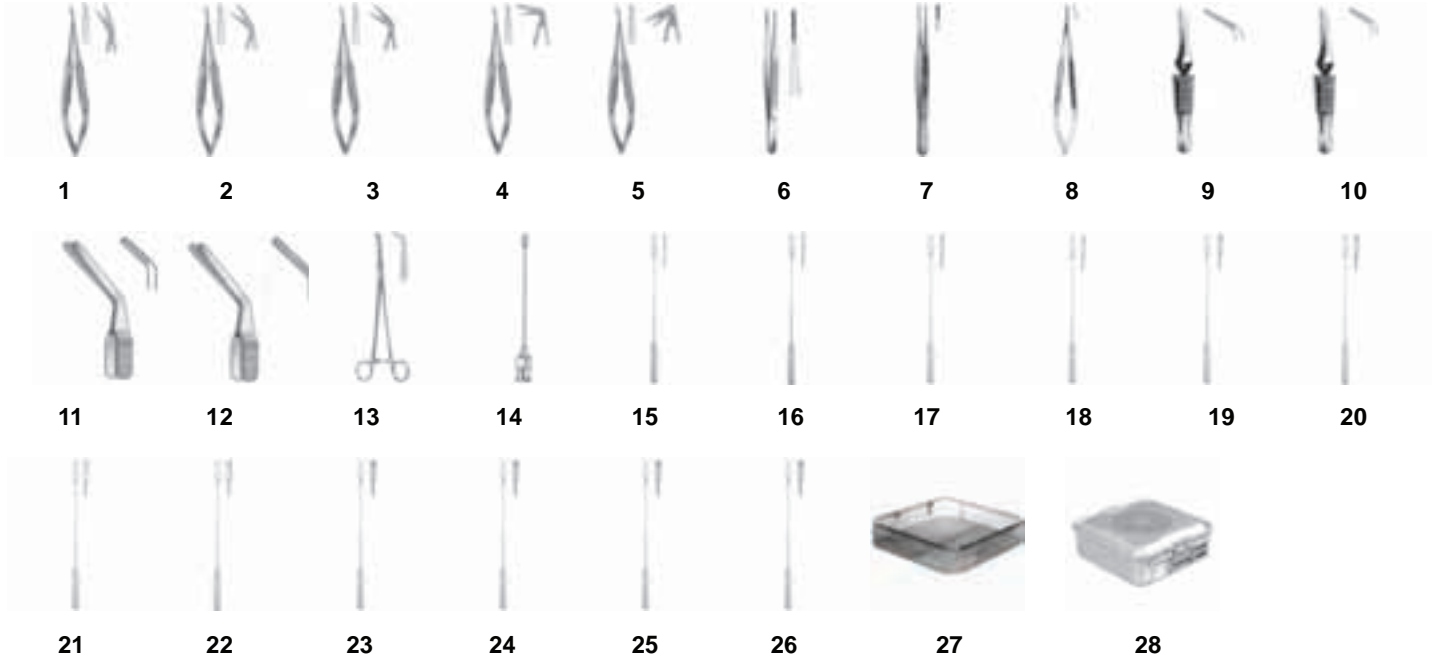

No	Quantity	Code	Description
1	1	C 135.00	Vascular Scissors 25° 18.5 cm
2	1	C 135.01	Vascular Scissors 45° 18.5 cm
3	1	C 135.03	Vascular Scissors 60° 18.5 cm
4	1	C 135.04	Vascular Scissors 90° 18.5 cm
5	1	C 135.06	Vascular Scissors 125° 18.5 cm
6	1	D 265.01	De Bakey Forcep 1.5 mm 20 cm
7	1	D 524.01	Chitwood-De Bakey Tissue Forcep 1.5 mm 19.5 cm
8	1	F 156.12	Micro Needle Holder 0.4x11 mm 18 cm
9	2	G 011.01	Diethrich Bulldog Clemp 4.5 cm
10	2	G 011.02	Diethrich Bulldog Clemp 4 cm
11	2	G 038.00	Featherlight Bulldog Clamp 10 mm 3 cm
12	2	G 038.01	Featherlight Bulldog Clamp 14 mm 3.3 cm
13	1	G 642.00	Mini-Gemini Dissecting Forcep 18 cm
14	3	J 307.01	Heparin Cannulae Ø 3 mm 4.5 cm
15	1	J 513.00	De Bakey Dilator Ø 0.5 mm 14 cm
16	1	J 513.01	De Bakey Dilator Ø 1 mm 14 cm
17	1	J 513.02	De Bakey Dilator Ø 1.5 mm 14 cm
18	1	J 513.03	De Bakey Dilator Ø 2 mm 14 cm
19	1	J 513.04	De Bakey Dilator Ø 2.5 mm 14 cm
20	1	J 513.05	De Bakey Dilator Ø 3 mm 14 cm
21	1	J 513.06	De Bakey Dilator Ø 3.5 mm 14 cm
22	1	J 513.07	De Bakey Dilator Ø 4 mm 14 cm
23	1	J 513.08	De Bakey Dilator Ø 4.5 mm 14 cm
24	1	J 513.09	De Bakey Dilator Ø 5 mm 14 cm
25	1	J 513.11	De Bakey Dilator Ø 7 mm 14 cm
26	1	J 513.13	De Bakey Dilator Ø 9 mm 14 cm
27	1	Y 390.05	Wire Basket, 255x245x50 mm
28	1	Y 310.10	1/2 Size Container, 285x280x100 mm

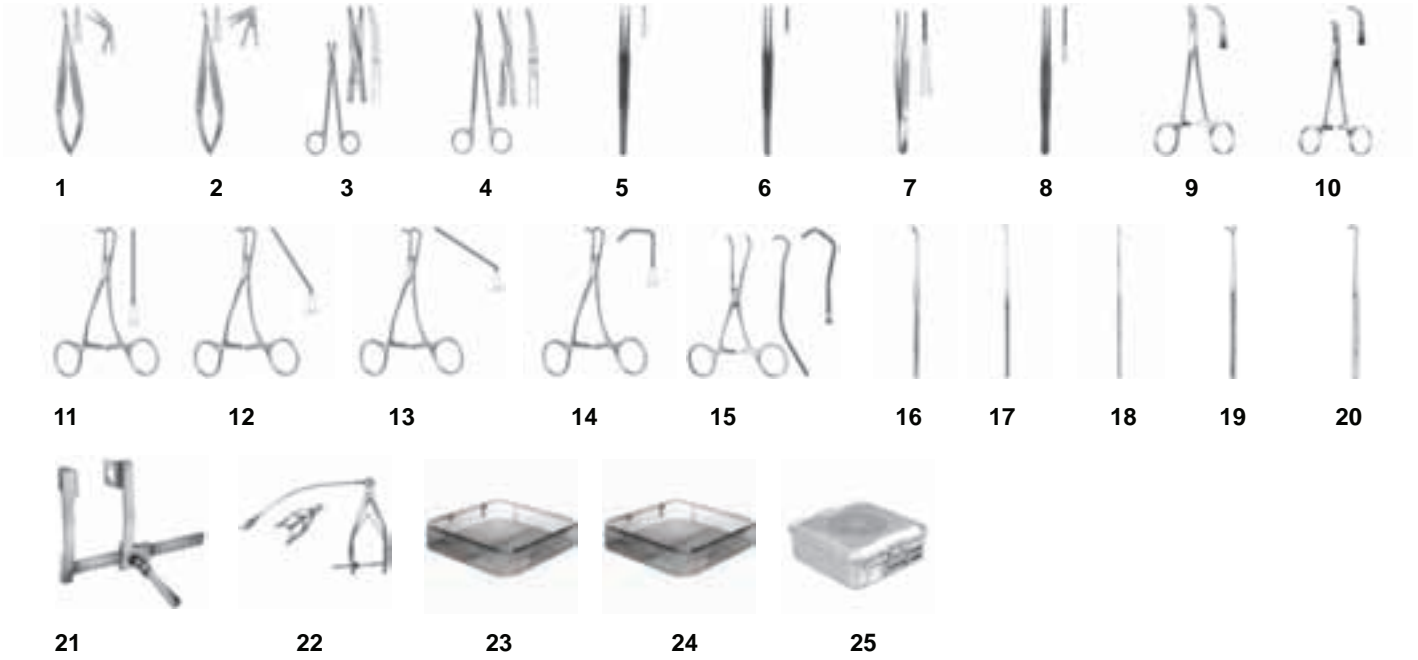

No	Quantity	Code	Description
1	1	C 134.03	Vascular Scissors 60° 18.5 cm
2	1	C 134.06	Vascular Scissors 125° 18.5 cm
3	1	C 756.00	Metzenbaum Dissecting Scissors Curved 14.5 cm
4	1	C 758.00	Toennis-Adson Dissecting Scissors Curved 17.5 cm
5	1	D 171.02T	Titanium Forcep 1.3x2.0 mm 18 cm
6	1	D 260.02T	Titanium Forcep 1.0 mm 18 cm
7	1	D 265.01	De Bakey Forcep 1.5 mm 20 cm
8	1	D 267.01T	Titanium Forcep 1.0 mm 15 cm
9	1	G 614.00	Micro-Adson Dissecting Forcep 14 cm
10	1	G 617.00	Baby-Adson Dissecting Forcep 14 cm
11	1	H 603.00	Neonatal and Pediatric Clamp 14 cm
12	1	H 603.02	Neonatal and Pediatric Clamp 14 cm
13	1	H 603.03	Neonatal and Pediatric Clamp 13 cm
14	1	H 603.07	Neonatal and Pediatric Clamp 13 cm
15	1	H 609.00	Cooley Bulldog Clamp 12x50 mm 11.5 cm
16	1	K 109.00	Zenker Vessel Hook 3x10 mm 18.5cm
17	1	K 135.00	Pbi Vessel Hook 90° 19 cm
18	1	K 141.00	Pbi Vessel Hook 90° 19 cm
19	1	K 152.00	Vessel Hook 8x12 mm 17.5 cm
20	1	K 153.00	Vessel Hook 12x5 mm 17.5 cm
21	1	L 807.00	Rib Spreader 12x14x18 cm
22	1	R 861.01	Cooley Aortic Dilator Blade opening 8-15 mm
23	1	Y 390.03	Wire Basket, 255x245x30 mm
24	1	Y 390.05	Wire Basket, 255x245x50 mm
25	1	Y 310.10	1/2 Size Container, 285x280x100 mm

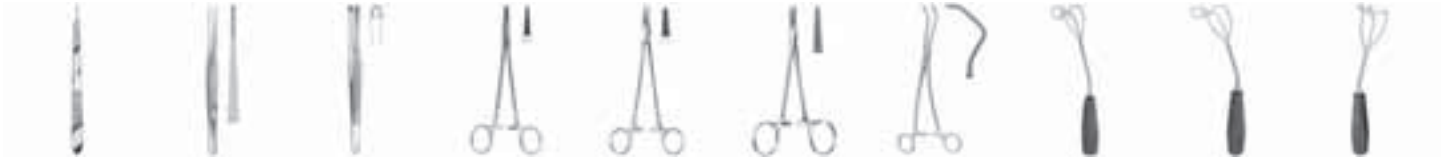

1

2

3

4

5

6

7

8

9

10



11



12



13

No	Quantity	Code	Description
1	1	B 030.02	Scalpel Handle No 3 21.5 cm
2	1	D 265.02	De Bakey Forcep 1.5 mm 24 cm
3	1	D 390.02	Russ Modell Tissue Forcep 25 cm
4	1	F 347.01	Needle Holder 20 cm
5	1	F 355.00	Hegar-Mayo Needle Holder 15 cm
6	12	G 214.00	Halsted-Mosquito Delicate Haemostatic Forceps Straight 12.5 cm
7	1	H 568.00	De Bakey-Harken Vena Cava Clamp 86 mm 24.5 cm
8	1	K 695.01	Cooley Retractor Slightly Serrated 45x35 mm 26.5 cm
9	1	K 695.02	Cooley Retractor Slightly Serrated 45x48 mm 26.5 cm
10	1	K 697.02	Cooley Retractor Left 25x46 mm 28 cm
11	1	L 865.00	Minimally Invasive Surgery Systems Complete
12	1	Y 290.05	Wire Basket, 405x255x50 mm
13	1	Y 210.10	3/4 Size Container, 465x280x100 mm

ALPHABETICAL INDEX
NUMERICAL INDEX

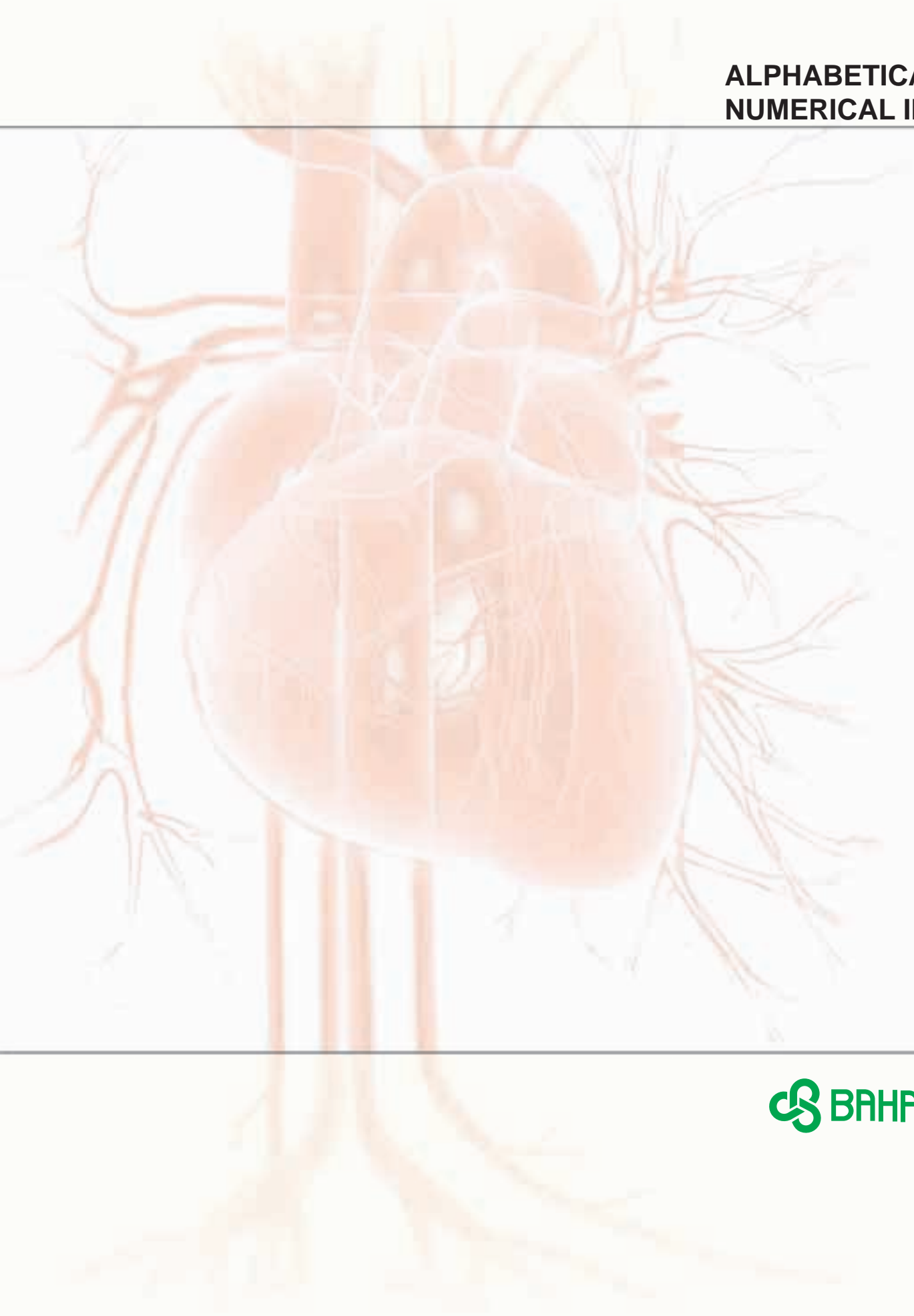

	Sayfa		Sayfa
A		BLANCO , ekartörler	236
ABDOMINAL ekartör	187	BOHLER , kemik kesme pensleri	267
ADLERKEUTZ , damar ve tümör pensetleri	35	BONNEY , HARDTIPS dişli doku pensetler	45
ADSON , HARDTIPS diseksiyon pensetler	42	BOROWSKI , aort kapağı ekartörleri	238
HARDTIPS dişli doku pensi	42	BORST , tesbit klempleri	51
hassas dişli doku pensetler	32	BOSE , otomatik ekartörler	196
hassas hemostatik pensler	85	BOYS-ALLIS , organ ve doku tutma pensleri	53
otomatik ekartörler	199	BRAUN-STADLER , sternum makasları	258
raspalar	243	BRIDGE , hassas hemostatik pensler	87
TITANYUM, Hassas dişli doku penset,	47	BROCK'S , biyopsi pensleri	254
ADSON-BABY , otomatik ekartörler	197	ekartörler	237
ADSON-BROWN , HARDTIPS dişli doku pensler	42	BROM , ince yara ekartörleri	178
ALEXANDER , raspalar	244	BROMPTON , ALÜMİNYUM makaralı tüp saçıcılar	256
ALLENBERG , ATROMATİK hemostatik pensler	146	ekartörler	237
bleyd değiştirme pensi	202	BROPHY , hassas diseksiyon pensetler	34
buldog klempleri	255	BROWN , dişli doku pensleri	33
iliak ekartörler	202	BRUNNER , göğüs makasları	261
otomatik ekartörler	198	BRUNS , kemik küretleri	259
ALLIS , organ ve doku tutma pensleri	53-54	Buldog klempler	255
ALLISON , ciğer spatulaları	233	BURFORD , ALÜMİNYUM göğüs ekartörleri,	212
ALLPORT , otomatik ekartörler	196		
ALM , otomatik ekartörler	196	C	
ANKENEY , göğüs ekartörleri	217	CALNE , ATROMATİK karaciğer transplantasyon klempleri	144
ANTHONY , aspiratör uçları	254	CARREL , hassas hemostatik pensler	90
Aproksimatörler	74-75	CASPAR , ronjurlar	273
ATLEE , ATROMATİK bronş klempleri	137	CASTANEDA , ALÜMİNYUM göğüs ekartörleri	213
Atrial ekartörler	220-222-223-226	ATROMATİK, anastomoz ve çok amaçlı klempler	105
ATROMATİK, çok amaçlı damar klempleri	108-124	yenidoğan ve çocuk klempleri	91
damar klempler	174	CASTROVIEJO , HARDTIPS portegüler	64
damar klipleri	78	Cerrahi makaslar standart model	18-19
duktus klempler	160	CHAFOORD-SELLORS , aort klempler	172
Hemostatik pensler	102	CHEVALIER-JACKSON'S , aspiratör uçları	254
hemostatik pensler	102-148	CHITWOOD-DE BAKEY , HARDTIPS dişli doku pensetler	44
koarktasyon klempler	160	Ciğer spatulaları	231-233
periferik damar klempler	118	CLELAND'S , ekartörler	185
ultra hafif pensetler	38	COLLIN göğüs makasları	261
yenidoğan ve çocuk klempleri	164-165	organ ve doku tutma pensleri	55
AUSTIN , mikro suture bağlama pensleri	32	CONVERSE , HARDTIPS portegüler	65
		COOLEY , ALÜMİNYUM göğüs ekartörleri,	211-214
B		aort dilatörleri	252
BABCOCK , organ ve doku tutma pensleri	54	atrial ekartörler	220-222-226
varis sondaları	247	atrium ekartörler	239-240-241
BABY MOSQUITO , hassas hemostatik pensler	84	ATROMATİK, anastomoz klempler	153-154-156-157-158
BABY-ADSON , diseksiyon pensler	90	ATROMATİK, anastomoz ve çok amaçlı klempler	106-
BABY-CRILE-WOOD , HARDTIPS portegüler	65	107-159	
BABY-METZENBAUM , HARDTIPS diseksiyon makaslar	23-28	ATROMATİK, buldog klempler	150-151
BABY-MIXTER , diseksiyon pensler	90	ATROMATİK, çok amaçlı klempler	161-162-163
BABY-SATINSKY , anastomoz klempler	170	ATROMATİK, duktus klempleri	160
BACKHAUS , çamaşır klempleri	52	ATROMATİK, koarktasyon klempler	160
Bağlantı klempleri	219-220-222-223-227	ATROMATİK, pensetler	36
BAILEY , göğüs ekartörleri	260	damar dilatörleri	248
BAILEY-OCHSNER , diseksiyon pensleri	98	ekartörler	228
BAUMGARTNER , HARDTIPS portegü	72	göğüs ekartörleri	215
Bayonet pensetler	39	kanüller	177
BECK , ATROMATİK anastomoz klempler	154	spatulalar	228
ATROMATİK, çok amaçlı damar klempler	108	sternum ekartörler	205
BECKMANN-EATON , otomatik ekartörler	199	valf ekartörler	222
BEEBE , tel kesme makasları	26	COOLEY-BECK , ATRAUMATİK anastomoz klempler	153
BELCHER'S , hassas hemostatik pensler	87	COOPER , cerrahi makaslar, standart model	19
BETHUNE , göğüs makasları	260	CORYLLOS , ciğer spatulaları	234
BERRY , sternal için portegü	72	CRAFOORD , aort klempler	172
BIEMER , aproksimatörler	75	hassas hemostatic pensler	87
damar klipleri için pensetler	77	damar klempler	174
mikro damar klipleri	76	ekartörler	236
mikro damar makasları	5	CRILE , ince yara ekartörleri	178
sinir ve damar hukları	179	portegüler	63
BIEMER-MULLER , aproksimatörler	74	CRILE-WOOD , HARDTIPS portegüler	65
mikro aproksimatörler	74-77	CUSHING , ekartörler	181
Bistüri sapları	2-3	HARDTIPS diseksiyon pensetler	43
BLAKE , embolus tutma pensleri	51-247	hassas diseksiyon pensetler	34
		ince yara ekartörleri	178

Sayfa	Sayfa		
TITANYUM, diseksiyon pensetler,	48	Dişli doku pensetler	33
TITANYUM, hassas diseksiyon pensetler	48	DOYEN , raspalar	245
Çatal sabitleyiciler	222-223-224	DUVAL , organ ve doku tutma pensleri	55
CUSHING-KOCHER , ekartörler	181		
D		E	
DALE , ATROMATİK periferik damar klempleri	117	ECHLIN , kemik ronjurları	263
Damar dilatörleri	251	Ekartörler	182-186-236
Damar makasları	20	Endarterektomi Temizleyiciler	249
Damar ölçme aletleri	121	Ekstra dönen sürgü	220
Damar tutucuları	223-224	F	
DARDIK , ATROMATİK çok amaçlı klempler	149	FAVALORO , damar makasları	14-15
DAVIDSON , çiğir spatulaları	232	FEATHERLIGHT , bulldog klempler	81
DAVIS , disektörler	242	FERGUSON , aspiratör uçları	176
DE BAKEY , ATROMATİK anastomoz ve çok amaçlı klempler	106	kemik tutma pensleri	262
ATROMATİK aort anevrizma klempleri	127-128-129-130	FERRIS-SMITH , HARDTIPS diseksiyon pensetler	43
ATROMATİK aort klempler	133	FINOCHIETTO , ALÜMİNYUM göğüs ekartörleri	211-214
ATROMATİK bulldog klempler	82-83-104	ALÜMİNYUM torasik ekartörler	210
ATROMATİK çok amaçlı klempler	108-125	diseksiyon ve dikiş pensler	99-100
ATROMATİK diseksiyon ve dikiş pensleri	139-140-141	göğüs ekartörleri	200-202-204
ATROMATİK duktus klempler	115	HARDTIPS portegüler	73
ATROMATİK koarktasyon klempler	122	FINOCHIETTO-BABY-HAIGHT , ALÜMİNYUM göğüs ekartörleri	211
ATROMATİK mikro pensetler	36	FINOCHIETTO-BURFORD , göğüs ekartörleri	207
ATROMATİK pensetler	36-37	FINSEN , Otomatik ekartörler	196
ATROMATİK pensetler, TITANYUM	49	FINSTERER , kanüller	177
ATROMATİK periferik damar klempler	115-116	FISCH , sinir ve damar hukları	179
ATROMATİK tanjensiyel oklüzyon klempler	113	FOERSTER-BALLANGER , organ ve doku tutma pensleri	52
damar dilatörleri	247-248	spanç pensleri	52
damar makasları	13-14	FRAZIER , aspiratör uçları	176
diseksiyon ve dikiş pensleri	99		
göğüs ekartörleri	206-208-209-218	G	
HARDTIPS damar makasları	25	GARRET , dilatörler	248
HARDTIPS mikro dişli doku pensetler	44	GEMINI , diseksiyon ve dikiş pensleri	95
HARDTIPS portegüler	66	GERALD , bayonet pensetler	39
kanüller	177	HARDTIPS, dişli doku pensetler	45
TITANYUM ultra hafif pensetler	49	mikro pensetler	39
DE BAKEY-BAINBRIDGE , ATROMATİK hemostatik pensler	102	GIERTZ-STILLE , göğüs makasları	261
DE BAKEY-BECK , ATROMATİK vena kava klempler	112	GILLIES , HARDTIPS dişli doku pensetler	45
DE BAKEY-HARKEN , ATROMATİK vena kava klempler	112	GILLIES , ince yara ekartörleri	178
DE BAKEY-HES , bulldog klempler	80	GLASSER , mikro portegüler	61
DE BAKEY-KELLY , ATROMATİK hemostatik pensler	102	GLOVER , ATROMATİK anastomoz klempler	110-111
DE BAKEY-MIXTER , ATROMATİK diseksiyon ve dikiş pensleri	140	ATROMATİK, bulldog klempler	82
DE BAKEY-PEAN , ATROMATİK hemostatik pensler	103-152	ATROMATİK, çok amaçlı klempler	108
DE BAKEY-REYNOLDS , ATROMATİK anastomoz klempler	110-111	GLUCK , göğüs makasları	261
DE BAKEY-RUMEL , ATROMATİK diseksiyon ve dikiş pensleri	140	GOSLEE , tel tutma pensleri	270
DE BAKEY-SATINSKY , ATROMATİK tanjensiyel oklüzyon klempler	113	Göğüs ekartörleri	201-216-218-229
DE BAKEY(LAMBERT) , ATROMATİK aort anastomoz klempler	136	Göğüs makasları	261
DE BAKEY(MORRIS) , ATROMATİK asendan aort çapraz klempler	126	Göğüs tüpü yerleştirme pensleri	256
DE BAKEY(SEMB) , ATROMATİK aort anevrizma klempler	128	GRANT , ATROMATİK aort anevrizma klempleri	131
DE MARTEL , damar makasları	15	GREGORY , ATROMATİK damar klempleri	119
DEAVER , ekartörler	190-191-192-193-194-195	GREGORY-SOFT , ATROMATİK bulldog klempler	82
DEMOS , ATROMATİK damar klempleri	119	GUNNAR-HEY , ALÜMİNYUM makaralı tüp sağıcılar	256
DERRA , ATROMATİK anastomoz ve çok amaçlı klempler	107		
DERRA-COOLEY , ATROMATİK anastomoz klempler	154	H	
DESMARRES , ince yara ekartörleri	180	HAGMÜLLER , ATROMATİK aort anevrizma klempler	127
DIAMOTE, mikro pensetler	40-41	HAIGHT , göğüs ekartörleri	201
DIAMOTE, mikro portegüler	58-59-60-61	HALLE , elevatörler	242
DIAMOTE, mikro pensetler, TITANYUM	46	HALSEY , HARDTIPS portegüler	65
DIAMOTE, mikro portegüler, TITANYUM	60-61	HALSTEAD , hassas hemostatik pensler	85
DICK , ATROMATİK anastomoz ve çok amaçlı klempler	147	HALSTEAD-MOSQUITO , hassas hemostatik pensler	84-86
DIETHRICH , ATROMATİK aort klempler	132	HARDTIPS cerrahi makaslar	22
bulldog klempler	80	HARDTIPS cerrahi makaslar, GRIPCUT	29
damar makasları	13-15	HARDTIPS dikiş makasları, GRIPCUT	27
DIETHRICH-HEGEHANN , damar makasları	13	HARDTIPS diseksiyon pensetler,	42-43
DIETHRICH-POTTS , mikro damar makasları	16	HARDTIPS portegüler	66-69-71-73
DIEFFENBACH , bulldog klempler	80	HARDTIPS tel bükücüler	72
DIXON-LOVELACE , hassas hemostatik pensler	85	HARDTIPS tel kesme makasları	26
Dikiş pensleri	90	HARKEN , vena-kava klempler	170-171
Diseksiyon pensetler	34		
Diseksiyon pensleri	90		
Disektörler	242		

Alfabetik İndeks

	Sayfa		Sayfa
HARRINGTON , ciğer spatulaları	230	LELAND-JONES , ATROMATİK periferik damar klempler	116
HARRINGTON-PEMBERTON , ciğer spatulaları	230	LEMMON , göğüs ekartörleri	260
HARVEY , tel kesme makasları	26	LERICHE , hassas hemostatik pensler	84
tel kesme pensleri, Elmas Kesici ağız	271	LEXER , HARDTIPS diseksiyon makasları	23
Hassas makaslar	12	HARDTIPS diseksiyon makasları, GRIPCUT	29
HEANEY HARDTIPS, portegüler	67	LICHTENBERG , HARDTIPS portegüler	71
HEGAR HARDTIPS, portegüler	67	LISTON , kemik kesme pensleri	266-268
HEISS , hassas hemostatik pensler	86	LISTON-KEY-HORSLEY , kemik kesme pensleri	269
HELLBERG-KUPKA , damar makasları	17	LISTON-STILLE , kemik kesme pensleri	269
HARDTIPS portegüler	68	LITTLEWOOD , doku tutma pensleri	50
portegüler	62	LOVELACE , organ ve doku tutma pensleri	55
HENLY , ATROMATİK anastomoz ve çok amaçlı klempler	109	LUC , ronjurlar	273
HEPARIN , kanüller	177	LUER-STILLE , kemik ronjuru	264
HERTZLER , göğüs ekartörleri	200		
HILUS-PULMONIS , diseksiyon pensleri	98	M	
HONGKONG-SATINSKY , ATROMATİK karaciğer transplantasyon klempler	143	MANNERFELT , ince yara ekartörleri	180
HOPFNER , damar klempleri	170	MARGERBER , ekartörler	181
HOPT , ATROMATİK böbrek ve pankreas klempleri	142	MARKWALDER , kemik ronjuru	265
HOSEMANN , hassas hemostatik pensler	86	MASETTI , anastomoz ekartörler	225
HUSFELD , ATROMATİK periferik damar klempler	120	koroner sabitleyici	225
		MATHIEU HARDTIPS portegüler	71
I		portegüler	63
Ince yara ekartörleri	180	MATHIEU-STILLE portegüler	63
IMA Bleydleri	221	MAYO , HARDTIPS diseksiyon makasları	22
		MAYO-HEGAR , HARDTIPS portegüler	65
J		MC INDOE , kemik kesme pensleri	267
JACOBSEN diseksiyon pensler	98	MEHDORN , damar klip	76
mikro makaslar	5	damar klipleri için pensetler	77
JAMESON , diseksiyon makaslar	18	METZENBAUM , HARDTIPS diseksiyon makaslar	23-24-25-28-29
JAMESON-WERDER , diseksiyon makaslar	18	MICRO-ADSON , hassas diseksiyon pensetler	32
JANSEN , otomatik ekartörler	196	hassas dişli doku pensetler	32
JAVID , ATROMATİK karotis şant klempler	121	MICRO-HALSTEAD , hassas hemostatik pensler	84
JENKER , alet seti	121	MİKRO-ADSON , diseksiyon pensler	90
JOHNS-HOPKINS , bulldog klempler	80	MIKULICZ , ekartörler	187
damar klipleri için pensetler	77	MILLESİ , mikro makaslar	5
JOSEPH , hassas makaslar	18	MILLS , damar makasları	14
		MINI-FINOCHIETTO , ALÜMİNYUM torasik ekartörler	210
K		MINI-GEMINI , diseksiyon ve dikiş pensleri	93
KADER , ekartörler	185	MITCHELL , ATROMATİK aort klempler	134
KANTROWITZ , diseksiyon ve dikiş pensleri	92	MIXTER , diseksiyon ve dikiş pensleri	94-100
KELLY , hassas makaslar	18	MIXTER-O'SHAUGNESSY , diseksiyon ve dikiş pensleri	94
Kemik ekartörleri	183	Mikro dikiş makasları	11
Kemik kesme pensleri	266-267	Mikro diseksiyon makaslar	4
Kemik tutma pensleri	262	Mikro makaslar	4-5-7-8-9-11
KILNER , ince yara ekartörleri	178	Mikro pensetler	39
Klempler	257	Mikro portegüler	56
KLINKENBERGH-LOTH , damar makasları	21	Mikro Sütüre Bağlama pensetler	31-32
KOCHER , ekartörler	181-188	Mini Torakotomi ekartörler	220
hemostatik pensler	93	MOBERG , ekartörler	236
KOCHER-LANGENBECK , ekartörler	184	MORRIS , ATROMATİK asendan aort çapraz klempler	126
KOCHER-OCHSNER , hemostatik pensler	89	MORRIS-DE BAKEY , ATROMATİK asendan aort çapraz klempler	126
KOCHER-WAGNER , ekartörler	188	MORSE , sternum ekartörler	206
Konik uçlu delme boruları	253	MORSE-FAVALORO , ALÜMİNYUM göğüs ekartörleri	215
KÖNIG , ekartörler	181	MOSQUITO , ATROMATİK hemostatik pensler	102
KRAYENBUHL , sinir ve damar hukları	179	MÜLLER , mikro portegüler	57
		ATROMATİK damar klempler	166-167-168-169
L		ATROMATİK damar klip	79
LAMBERT-KAY , ATROMATİK aort anastomoz klempler	136	ATROMATİK klempler için silikon ağız	166-167
LAMBOTTE , raspalar	244	dikiş pensleri	78
LANE , doku tutma pensleri	50	ince yara ekartörleri	178
LAHGENBECK , HARDTIPS portegüler	70	mikro makaslar	6
raspalar	244	mikro pensetler	30
ekartörler	184-185	travmatik olmayan damar klipleri	78
kemik tutma pensleri	262	MYERS , damar temizleyiciler	247
LAWRENCE , diseksiyon ve dikiş pensleri	96		
LAZAR , mikro sütür bağlama pensetleri	32	N	
LEBSCHÉ , sternum çizillir	258	NABATOFF , varis aletleri	246
LEES , ATROMATİK bronş klempleri	137-138	NELSON , ciğer tutma penseti	35
LEITZ , ATROMATİK anstomoz klempler	155	NELSON-METZENBAUM , HARDTIPS diseksiyon makaslar	24-29

Alfabetik İndeks

	Sayfa		Sayfa
NELSON-METZENBAUM(MC INDORE),		SAUERBRUCH-FREY, göğüs makasları	261
HARDTIPS diseksiyon makaslar	25	SAURBRUCH-CORYLLOS, kemik ronjurları	265
NOON ATROMATİK, buldog pensler	104	SCHEDE, kemik küretleri	259
O		SCHMID, damar temizleme kanülleri	250
OCHSNER, ATROMATİK aort klempler	132	disektör	242
OEHLER, HARDTIPS dişli doku pensetler	45	SCHMIEDEN-TAYLOR, dura makasları	12
OELERT, sternum ekartörleri	258	SCHULZ, biyoptom	252
OLDBERG, ronjurlar	273	SCHUMACHER, sternum makasları	258
OLIVECRONA, dura makasları	12	SELLORS, göğüs ekartörleri	217-260
Organ ve doku tutma pensleri	52	SEMB, diseksiyon ve dikiş pensleri	172
OSHAUGHNESSY, diseksiyon ve dikiş pensleri	99	kemik ronjurları	264
Otomatik ekartörler	196-198	kemik tutma pensleri	262
OVERHOLT, diseksiyon ve dikiş pensleri	94	raspalar	244
OVERHOLT-MIXTER, diseksiyon ve dikiş pensleri	92	Serklaj telleri	249
OVERHOLT-GIESSENDOERFER, diseksiyon ve dikiş pensleri	93	SHUNT, buldog klempler	81
Pansuman pensleri	50	SIMON, ekartörler	186
P		SIMS-MAIER, spanç pensleri	50
PARRY-COOLEY ATROMATİK anastomoz klempler	155	Sinir ve damar hukları	179
ATROMATİK çok amaçlı klempler	163	SKINNER, HARDTIPS dişli doku pensetler	45
PBI, ince yara ekartörleri	178	Spatulalar	220-222-225
PEAN, ATROMATİK hemostatik pensler	102	SPERONI-ALEXI, göğüs ekartörleri	217
PENNY-BAKER, raspalar	243	Sternum ekartörler	203
PERTUISET, karotis klempler	80	STILLE, damar ve tümör pensetler	35
PERWITZSCHKY, hassas makaslar	12	kemik ronjurları	263
PLESTER, aspiratör uçları	176	STRUCK, göğüs ekartörleri	200
POST-YASARGIL, mikro makaslar	5	STRULLY, damar makasları	20
POTTS, ATROMATİK anastomoz klempler	111	SUBRAMANIAN, ATROMATİK aort klempler	134
ATROMATİK karaciğer transplantasyon klempler	145	SUBRAMANIAN(modif.), ATROMATİK aort klempler	133
ATROMATİK koarktasyon klempler	123	SWEDISH, disektörler	242
POTTS-DE MARTEL, damar makasları	13	T	
POTTS-SMITH, damar makasları	14-21	T Cubuklar	222-227
PRICE-THOMAS, bronş pensler	173	TEALE, doku tutma pensleri	51
R		Tel bükücüler	270
RANKIN, hassas hemostatik pensler	85	Tel çıkarma pensleri	270
REILL, mikro portegüler	56	Tel kesme pensleri	272
tel kesme makasları	272	Tel kesme pensleri, elmas kesici ağız	271
REIN, ATROMATİK anastomoz ve çok amaçlı klempler	109	Tesbit klempleri	51
REIN-KUPKA, diseksiyon makasları	17	THOREK, damar makasları	21
HARDTIPS portegüler	68	TITANYUM, diseksiyon pensetler	48
portegüler	62	TITANYUM, hassas diseksiyon pensetler	46-48
RIENHOFF-FINOCCHIETTO, göğüs ekartörleri	216	TITANYUM, mikro pensetler, ATROMATİK	46
RIESS, koroner sabitleyici	225	TITANYUM, mikro pensetler kuyumcu tipi	46
ROBB, disektör	243	Torasik ekartör bleydi	222
ROBERTS, diseksiyon pensleri	98	TÖNNIS, disektörler	242
hassas hemostatik pensler	87	HARDTIPS portegüler	70
ROCHESTER-PEAN, hemostatik pensler	88	portegüler	63
ROSS, atrial ekartörler	222-226	Torasik ekartörler	209-221-222-223
ekartörler	236	TÖNNIS-ADSON, HARDTIPS diseksiyon makasları	24-28
ROUX, ekartörler	182	TUBBS, aort dilatörleri	252
RUMEL, diseksiyon ve dikiş pensleri	92-96	TUDOR-EDWARDS, ekartörler	237
RUMEL-BELMONT, turnikeler	250-251	TUFFIER, göğüs ekartörleri	201
RUSKIN-LISTON, kemik kesme pensleri	267	Turnikeler	250-251
RUSS MODELL, dişli doku pensetler	35	TUTTLE, ciğer tutma pensetleri	35
RYDER, DIAMOTE mikro portegüler	61	TÜBINGER, ekartörler	186
HARDTIPS portegüler	69	Tünel pensleri	253
S		Tüp klempleri	97
Sabitleyiciler	222-223-224	V	
SAROT, HARDTIPS portegüler	67	Valf ekartörleri	219
SATINSKY, ATROMATİK damar klempler	174-175	Valf ekartör bleydleri	219
ATROMATİK tanjensiyel oklüzyon klempler	114	VALVULOTEME, dilatörler	247
damar klempler	171	VANNAS, mikro makaslar	5
damar makasları	21	VARADY, çıkartıcılar	246
SAUERBRUCH, ciğer spatulaları	235	disektörler	246
göğüs makasları	260	spatulalar	246
SAUERBRUCH-BRITSCH, göğüs makasları	260	varis aletleri	246
	260	VOLKMANN, ekartörler	182-183
	260	kemik küretleri	259

	Sayfa	Sayfa
W		
WACHTEL , HARDTIPS portegüler	64	
WACHTEL , DIAMOTE mikro diseksiyon pensetler	41	
WACHTEL , DIAMOTE Mikro dişli doku pensetler	41	
WANGENSTEEN , HARDTIPS diseksiyon pensetler	43	
HARDTIPS portegüler	73	
WARKWALDER , kemik ronjurları	265	
WATSON-CHEYNE , disektörler	242-243	
WEBER , ATROMATİK aort anastomoz klempler	135	
WEITLANER , Otomatik ekartörler	197-198	
WERTHEIM HARDTIPS diseksiyon makasları	25	
HARDTIPS portegüler	67	
kompres pensleri	101	
WERTHEIM-CULLEN kompres pensleri	101	
WIKSTROEM diseksiyon ve dikiş pensleri	94	
WILLIAMS HARDTIPS dişli doku pensetler	45	
organ ve doku tutma pensleri	51	
WILLIGER kemik küretleri	259	
WITT sternal delme igneleri	258	
WYLIE ATROMATİK damar klempler	120	
Y		
Yan torasik bleyd	221	
YANKAUER , kanüller	177	
YASARGIL , mikro makaslar	5	
Yan torasik bleyd	221	
Z		
ZANGER , ATROMATİK aort klempler	134	
ZENKER , diseksiyon ve dikiş pensleri	95	
ekartörler	189	
ince yara ekartörleri	180	
ZWEIFEL HARDTIPS portegüler	71	

Sayfa

Sayfa

	Page		Page
A		Bone retractors	183
ADLERKEUTZ , vascular and tumor forceps	35	BONNEY , HARDTIPS tissue forceps	45
vascular and tumor forceps	35	BOROWSKI , aorta valve retractors	238
ADSON , delicate hemostatic forceps	85	BORST , fixation clamps	51
HARDTIPS tissue forceps	42	BOSE self-retaining retractors	196
delicate tissue forceps	32-47	BOYS-ALLIS , organ and tissue grasping forceps	53
HARDTIPS dissecting forceps	42	BRAUN-STADLER sternum scissors	258
raspatories	243	BRIDGE delicate hemostatic forceps	87
self-retaining retractors	199	BROCK'S biopsy forceps	254
TITANIUM delicate tissue forceps	47	retractors	237
ADSON-BABY , self-retaining retractors	197	BROM fine wound retractors	178
ADSON-BROWN , HARDTIPS tissue forceps	42	BROMPTON ALUMINIUM tube milking rollers	256
ALEXANDER , raspatories	244	retractors	237
ALLENBERG , forceps	202	BROPHY delicate dissecting forceps	34
ALLENBERG , ATRAUMATIC hemostatic forceps	146	BROWN tissue forceps	33
bulldog clamps	255	BRUNNER rib shears	261
iliaca retractors	202	BRUNS bone curettes	259
self-retaining retractors	198	Bulldog clamps	81-255
ALLIS , organ and tissue grasping forceps	53-54	BURFORD ALUMINIUM rib retractor	212
ALLISON , lung spatulas	233		
ALLPORT , self-retaining retractors	196	C	
ALM , self-retaining retractors	196	CALNE ATRAUMATIC liver transplantation clamps	144
ANKENEY , rib retractors	217	CARREL delicate hemostatic forceps	90
ANTHONY , suction tubes	254	CASPAR rongeurs	273
Approximators	74-75	CASTANEDA ALUMINIUM rib retractors	213
ATRAUMATIC, coarctation clamps	160	ATRAUMATIC anastomosis and multi-purpose clamps	105-106
ATRAUMATIC, hemostatic forceps	102-148	neonatal and pediatric clamps	91
ATRAUMATIC, multi-purpose clamps	108-124	CASTROVIEJO HARDTIPS needle holders	64
ATRAUMATIC, neonatal and pediatric clamps	164-165	Cerclage wires	249
ATRAUMATIC, peripheral vascular clamps	118	CHAFOORD-SELLORS aorta clamps	172
ATRAUMATIC, ultra light forceps	38	CHEVALIER-JACKSON'S suction tube	254
ATRAUMATIC, vascular clamps	174	CHITWOOD-DE BAKEY HARDTIPS tissue forceps	44
ATRAUMATIC, vessel Clips	78	Clamps	257
ATLEE , Atraumatic bronchus clamps	137	CLELAND'S retractors	185
Atrial retractors	220-222-223-226	COLLIN organ and tissue grasping forceps	55
AUSTIN , micro suture tying forceps	32	rib shears	261
		CONVERSE HARDTIPS needle holders	65
B		COOLEY ALUMINIUM rib retractors	211-214
BABCOCK , organ and tissue grasping forceps	54	aortic dilators	252
probes for varicose vein	247	ATRAUMATIC anastomosis and multi-purpose clamps	106-107-159
BABY MOSQUITO , delicate hemostatic forceps	84	ATRAUMATIC anastomosis clamps	153-154-156-157-158
BABY-ADSON , dissecting forceps	90	ATRAUMATIC bulldog clamps	150-151
BABY-CRILE-WOOD , HARDTIPS needle holders	65	ATRAUMATIC coarctation clamps	160
BABY-METZENBAUM , HARDTIPS dissecting scissors	23-28	ATRAUMATIC multi-purpose clamps	161-162-163
BABY-MIXTER , dissecting forceps	90	ATRAUMATIC ductus clamps	160
BABY-SATINSKY , vessel clamps	170	ATRAUMATIC forceps	36
BACKHAUS , towel clamps	52	atrium retractors	239-240-241
BAILEY , rib spreader	260	cannulae	177
BAILEY-OCHSNER , dissecting forceps	98	retractors	228
BAUMGARTNER , HARDTIPS needle holder	72	rib retractors	215
Bayonet-shaped forceps	39	spatulas	228
BECK , ATRAUMATIC anastomosis clamp	154	sternum retractors	205
ATRAUMATIC multi-purpose vascular clamps	108	valve retractors	222
BECKMANN-EATON , self-retaining retractors	199	vascular dilators	248-251
BEEBE , wire cutting scissors	26	COOLEY BECK , ATRAUMATIC anastomosis clamps	153
BELCHER'S , delicate hemostatic forceps	87	COOPER , surgical scissors, standard patterns	19
BERRY , needle holder	72	CORYLLOS , lung spatulas	234
BETHUNE , rib shears	260	CRAFOORD , aorta clamps	172
BIEMER , applying forceps for vessel clips	77	delicate hemostatic forceps	87
approximators	75	CRAWFORD , retractors	236
micro vein scissors	5	vascular clamps	174
micro vessel clips	76	CRILE , fine wound retractors	178
nerve and vessel hooks	179	needle holders	63
BIEMER-MÜLLER , approximators	74	CRILE-WOOD , HARDTIPS needle holders	65
micro approximators	74-77	CUSHING , delicate dissecting forceps	34
BLAKE , embolus grasping forceps	51-247	fine wound retractors	178
BLANCO , retractors	236	HARDTIPS dissecting forceps	43
BOHLER , bone cutting forceps	267	retractors	181
Bone cutting forceps	266-267	TITANIUM delicate dissecting forceps	48
Bone holding forceps	262		

	Page		Page
TITANIUM dissecting forceps	48	Dissecting and ligature forceps	92
CUSHING-KOCHER , retractors	181	Dissecting forceps	34-90
D		Dissectors	242
DALE , ATRAUMATIC peripheral vascular clamps	117	DOYEN , raspatories	245
DARDIK , ATRAUMATIC multi-purpose clamps	149	Dressing forceps	50
DAVIDSON , Lung spatulas	232	DUVAL , organ and tissue grasping forceps	55
DAVIS , dissectors	242	E	
DE BAKEY ,		ECHLIN , bone rongeurs	263
ATRAUMATIC, anastomosis and multi-purpose clamps	106	Enderarterectomy Strippers	249
ATRAUMATIC, aorta aneurysm clamps	127-128-129-130	Extraction pliers for wires	270
ATRAUMATIC, aorta clamps	133	Extra turnable crossbar	220
ATRAUMATIC, bulldog clamps	82-83	F	
ATRAUMATIC, bulldog clamps	104	FAVALORO , vascular scissors	14-15
ATRAUMATIC, coarctation clamps	122	FEATHERLIGHT , bulldog clamps	81
ATRAUMATIC, dissecting and ligature forceps	139-140-141	FERGUSON , bone holding forceps	262
ATRAUMATIC, forceps	36-37	suction tube	176
ATRAUMATIC, forceps, TITANIUM	49	FERRIS-SMITH , HARDTIPS dissecting forceps	43
ATRAUMATIC, micro forceps	36	FINOCCHIETTO , dissecting and ligature forceps	99-100
ATRAUMATIC, multi purpose clamps	108-125	FINOCHIETTI-BURFORD , rib retractors	207
ATRAUMATIC, peripheral vascular clamps	115-116	FINOCHIETTO , ALUMINIUM rib retractor	211-214
ATRAUMATIC, tangential occlusion clamps	113	ALUMINIUM thoracic retractor	210
ATRAUMATIC, ductus clamps	115	rib retractors	200-202-204
cannulaes	177	FINOCHIETTO-BABY-HAIGHT , ALUMINIUM rib retractors	211
dissecting and ligature forceps	99	FINOCHIETTO , HARDTIPS needle holders	73
HARDTIPS, micro tissue forceps	44	FINSEN Self-Retaining retractors	196
HARDTIPS, needle holders	66	FINSTERER cannulaes	177
HARDTIPS, vascular scissors	25	FISCH nerve and vessel hooks	179
rib retractors	206-208-209-218	Fine wound retractors	180
TITANIUM, ultra light forceps	49	Fixation clamps	51-219-220-222-223-227
vascular dilators	247-248	FOERSTER-BALLANGER , organ and tissue forceps	52
vascular scissors	13-14	sponge forceps	52
DE BAKEY-BAINBRIDGE , ATRAUMATIC hemostatic forceps	102	Fork stabilizers	222-223-224
DE BAKEY-BECK , ATRAUMATIC vena cava clamps	112	FRAZIER , suction tubes	176
DE BAKEY-HARKEN , ATRAUMATIC vena cava clamps	112	G	
DE BAKEY-HESS , bulldog clamps	80	GARRET , dilators	248
DE BAKEY-MIXTER , ATRAUMATIC dissecting and ligature forceps	140	GEMINI , dissecting and ligature forceps	95
DE BAKEY-PEAN , ATRAUMATIC hemostatic forceps	152	GERALD , bayonet-shaped forceps	39
DE BAKEY-REYNOLDS , ATRAUMATIC anastomosis clamps	110-111	HARDTIPS tissue forceps	45
DE BAKEY-RUMEL , ATRAUMATIC dissecting and ligature forceps	140	micro forceps	39
DE BAKEY-SATINSKY , ATRAUMATIC tangential occlusion		GIERTZ-STILLE , rib shears	261
clamps	113	GILLIES , fine wound retractors	178
DE BAKEY(LAMBERT) , ATRAUMATIC aorta anastomosis clamps	136	HARDTIPS tissue forceps	45
DE BAKEY(MORRIS) , ascending aorta cross clamps	126	GLASSER , micro needle holders	61
DE BAKEY(SEMB) , ATRAUMATIC aorta aneurysm clamps	128	GLOVER , ATRAUMATIC anastomosis clamps	110-111
DE MARTEL , vascular scissors	15	ATRAUMATIC bulldog clamps	82
DE-BAKEY-KELLY , ATRAUMATIC hemostatic forceps	102	ATRAUMATIC multi-purpose clamps	108
DE-BAKEY-PEAN , ATRAUMATIC hemostatic forceps	103	GLUCK , rib shears	261
DEAVER , retractors	190-191-192-193-194-195	GOSLEE , wire holding forceps	270
Delicate scissors	12	GRANT , ATRAUMATIC aorta aneurysm clamps	131
DEMOS , ATRAUMATIC vascular clamps	119	GREGORY , ATRAUMATIC vascular clamps	119
DERRA , ATRAUMATIC anastomosis and multi-purpose clamps	107	GREGORY-SOFT , ATROMATIK bulldog clamps	82
DERRA-COOLEY , ATRAUMATIC anastomosis clamps	154	GUNNAR-HEY , ALUMINIUM tube milking rollers	256
DESMARRES , fine wound retractors	180	H	
DIAMOTE, micro forceps	40-41	HAGMÜLLER , ATRAUMATIC aorta aneurysm clamps	127
DIAMOTE, Micro forceps, TITANIUM	46	HAIGHT , rib retractors	201
DIAMOTE, micro needle holders	58-59-60-61	HALLE , elevators	242
DIAMOTE, micro needle holders, TITANIUM	60-61	HALSEY , HARDTIPS needle holders	65
DICK ATRAUMATIC anastomosis and multi-purpose clamps	147	HALSTEAD , delicate hemostatic forceps	85
DIETHRICH , ATRAUMATIC aorta clamps	132	HALSTEAD-MOSQUITO , delicate hemostatic forceps	84-86
bulldog clamps	80	HARDTIPS, dissecting forceps	42-43
vascular scissors	15	HARDTIPS, ligature scissors, GRUPCUT	27
DIETHRICH-HEGEHANN , vascular scissors	13	HARDTIPS, needle holders	66-71-73
DIETHRICH-POTTS , vascular scissors	16	HARDTIPS, surgical scissors	22
DIFFERENBACH , bulldog clamps	80	HARDTIPS, surgical scissors, GRIPCUT	29
DIXON-LOVELACE , delicate hemostatic forceps	85	HARDTIPS, wire cutting scissors	26
		HARDTIPS, wire twisters	72

	Page		Page
HARKEN , vena-cava clomp	170-171	Ligature forceps	90
HARRINGTON , lung spatulas	230	LOVELACE , organ and tissue grasping forceps	55
HARRINGTON-PEMBERTON , lung spatulas	230	LUC , rongeurs	273
HARVEY , wire cutting forcep, with carbid cutting edges	271	LUER-STILLE , bone rongeurs	264
wire cutting scissors	26	Lung spatulas	231-233
HEANEY , HARDTIPS needle holders	67		
HEISS , delicate hemostatic forceps	86	M	
needle holders	62	MANNERFELT , Fine wound retractors	180
vascular scissors	17	MARBERGER , atrial retractors	222-226
HENLY , ATRAUMATIC anastomosis and multi-purpose clamps	109	MARKWALDER , bone rongeurs	265
HEPARIN , cannulaes	177	retractors	181
HERTZLER , rib retractors	200	MASETTI , anastomosis retractors	225
HILUS-PULMONIS , dissecting forceps	98	Coronary Stabilizers	225
HONGKONG-SATINSKY , ATRAUMATIC liver tranps clamps	143	MATHIEU , HARDTIPS needle holders	71
HOPFNER , vascular clamps	170	needle holders	63
HOPT , ATRAUMATIC kidney and pankreas clamps	142	MATHIEU-STILLE , needle holders	63
HOSEMANN , delicate hemostatic forceps	86	MAYO , HARDTIPS dissecting scissors	22
HUSFELD , ATRAUMATIC peripheral vascular clamps	120	MAYO-HEGAR , HARDTIPS needle holders	65
		MC INDOE , bone cutting forceps	267
J		MEHDORN , applying forceps for vessel clips	77
JACOBSON , dissecting forceps	98	vessel clips	76
micro scissors	5	MERBURG , MODELL wire holding foeceps	270
JAMESON , dissecting scissors	18	METZENBAUM , HARDTIPS dissecting scissors	23-24-25-28-29
JAMESON-WERDER , dissecting scissors	18	MICRO-ADSON , delicate dissecting forceps	32
JANSEN , Self-Retaining retractors	196	dissecting forceps	90
JAVID , ATRAUMATIC carotid shunt clamps	121	MICRO-HALSTEAD , delicate hemostatic forceps	84
JOHNS-HOPKINS , applying forceps for vessel clips	77	MIKULICZ , retractors	187
bulldog clamps	80	MILLES , micro scissors	5
JOSEPH , delicate scissors	18	MILLS , vascular scissors	14
		MINI-FINOCHIETTO , ALUMINIUM thoracic retractors	210
K		MINI-GEMINI , dissecting and ligature forceps	93
KADER , retractors	185	MITCHELL , ATRAUMATIC aorta clamps	134
KANTROWITZ , dissecting and ligature forceps	92	MIXTER , dissecting and ligature forceps	94-100
KELLY , delicate scissors	18	MIXTER-O-SHAUGNESSY , dissecting and ligature forceps	94
KILNER , fine wound retractors	178	Micro dissecting scissors	4
KLINKENBERGH , vascular scissors	21	Micro forceps	39
KOCHER , hemostatic forceps	93	Micro ligature scissors	11
retractors	181-188	Micro needle holders	56
KOCHER-LANGENBECK , retractors	184	Micro scissors	4-5-7-8-9-10-11
KOCHER-OCHSNER , hemostatic forceps	89	Micro Suture Tying Forceps	31-32
KOCHER-WAGNER , retractors	188	Mini Thoracotomy retractors	220
KÖNIG , retractors	181	MOBERG , retractors	236
KRAYENBUHL , nerve and vessel hooks	179	MORRIS , ATRAUMATIC ascending aorta cross clamps	126
		MORRIS-DE BAKEY , ATRAUMATIC ascending aorta cross clamps	126
L		MORSE , sternum spreaders	206
LAMBERT-KAY , ATRAUMATIC aorta anastomosis clamps	136	MORSE-FAVALORO , ALUMINIUM rib retractors	215
LAMBOTTE , raspatories	244	MOSQUITO , ATRAUMATIC hemostatic forceps	102
LANE , tissue grasping forceps	50	Multi-purpose vascular clamps	108
LANGENBECK , HARDTIPS needle holders	70	MÜLLER , ATRAUMATIC clamps with silicon mouth inserts	
raspatories	244	166-167	
bone holding forceps	262	ATRAUMATIC vessel clamps	166-167-168-169
retractors	184	ATRAUMATIC vessel clips	79
retractors	184-185	fine wound retractors	178
LAWRENCE , dissecting and ligature forceps	96	ligature forceps	78
LAZAR , micro suture tying forceps	32	micro forceps	30
LEBSCH , sternum chisels	258	micro needle holders	57
LEES , ATRAUMATIC bronchus clamps	137-138	micro scissors	6
LEITZ , ATRAUMATIC anastomosis clamps	155	vessel clips, non-traumatic	78
LELAND-JONES , ATRAUMATIC peripheral vascular clamps	116	MYERS , vein strippers	247
LEMMON , rib spreaders	260		
LERICHE , delicate haemostatic forceps	84	N	
LEXER , HARDTIPS dissecting scissors	23	NABATOFF , varix instruments	246
HARDTIPS dissecting scissors, GRIP CUT	29	NELSON , lung grasping forceps	35
LICHTENBERG , HARDTIPS needle holders	71	NELSON-METZENBAUM , HARDTIPS dissecting scissors	24-29
LISTON , bone cutting forceps	266-268	NELSON-METZENBAUM(MC INDORE) ,	
LISTON-KEY-HORSLEY , bone cutting forceps	269	HARDTIPS dissecting scissors	25
LISTON-STILLE , bone cutting forceps	269	Nerve and vessel hooks	179
LITTLEWOOD , tissue grasping forceps	50	NOON ATRAUMATIC bulldog clamps	104

	Page		Page
O			
OCHSNER ATRAUMATIC aorta clamps	132	SAUERBRUCH-CORYLLOS , bone rongeurs	265
OEHLER , HARDTIPS tissue forceps	45	Scalpel Handles	2-3
OELERT , sternum retractors	258	SCHEDE , bone curettes	259
OLDBERG , rongeurs	273	SCHMID , dissectors	242
OLIVECRONA , dura scissors	12	vessel irrigating cannulaes	250
Organ and tissue grasping forceps	52	SCHMIEDEN-TAYLOR , dura scissors	12
OSHAUGHNESSY , dissecting and ligature forceps	99	SCHULZ , biptomes	252
OVERHOLT , dissecting and ligature forceps	92-94	SCHUMACHER , sternum scissors	258
OVERHOLT-GIESSENDOERFER , dissecting and ligature forceps	93	Self-Retaining retractors	196-198
	92	SELLORS , rib retractors	217
OVERHOLT-MIXTER , dissecting and ligature forceps	92	rib spreader	260
P			
PARRY-COOLEY , ATRAUMATIC anastomosis clamps	155	SEMB , Bone holding forceps	262
ATRAUMATIC multi-purpose clamps	163	bone rongeurs	264
PBI , fine wound retractors	178	dissecting and ligature forceps	172
PEAN , ATRAUMATIC hemostatic forceps	102	raspatories	244
PENNYBAKER , raspatories	243	SHUNT , bulldog clamps	81
PERTUISET , carotid clamps	80	SIMON , retractors	186
PERWITZSCHKY , delicate scissors	12	SIMS-MAIER , sponge forceps	50
PLESTER , suction tube	176	SKINNER , HARDTIPS tissue forceps	45
POST-YASARGIL , micro scissors	5	Spatulas	220-222-223-225
POTTS , ATRAUMATIC anastomosis clamps	111	SPERONI-ALEXI rib retractors	217
ATRAUMATIC coarctation clamps	123	Stabilizers	222-223-224
ATRAUMATIC liver transplantation clamps	145	Sternum retractors	203
POTTS-DE MARTEL , vascular scissors	13-14	STILLE bone rongeurs	263
POTTS-SMITH , vascular scissors	21	STILLE-BARRAYA , vascular and tumor forceps	35
PRICE-THOMAS , bronchus forceps	173	STRUCK rib retractors	200
R			
RANKIN , delicate hemostatic forceps	85	STRULLY vascular scissors	20
REILL , micro needle holders	56	SUBRAMANIAN ATRAUMATIC aorta clamps	134
wire cutting pliers	272	SUBRAMANIAN(modif.) ATRAUMATIC aorta clamps	133
REIN , ATRAUMATIC anastomosis and multi-purpose clamps	109	Surgical scissors, standard pattern	19
	68	SWEDISH dissectors	242
REIN-KUPKA , HARDTIPS needle holders	68	T	
needle holders	62	T bar	222-223-227
dissecting scissors	17	TEALE tissue grasping forceps	51
Retractors	182-186-236	Thoracic retractors	209-221-222-223
RIENHOFF-FINOCCHIETTO , rib retractors	216	THOREK vascular Scissors	21
RIESS , coronary stabilizer	225	TITANIUM, micro forceps, ATRAUMATIC	46
Rib blade	229	TITANIUM, delicate dissecting forceps	46-48
Rib retractors	201-216-218	TITANIUM, dissecting forceps	48
Rib shear	261	TITANIUM, Micro forceps Jeweler Patterns	46
Rib spreaders	229	Tissue forceps	33
ROBB , dissectors	243	Tourniquets	250-251
ROBERTS , delicate hemostatic forceps	87	TÖNNIS , dissectors	242
dissecting forceps	98	HARDTIPS needle holders	70
ROCHESTER-PEAN , hemostatic forceps	88	needle holders	63
ROSS , atrial retractors	222-226	TÖNNIS-ADSON , HARDTIPS dissecting scissors	24-28
retractors	236	TUBBS , aortic dilators	252
ROUX , retractors	182	TUBINGER , retractors	186
RUMEL , dissecting and ligature forceps	96	Tubing clamps	97
RUMEL-BELMONT , tourniquets	250-251	TUDOR-EDWARDS retractors	237
RUSKIN-LISTON , bone cutting forceps	267	TUFFIER , rib retractors	201
RUSS MODELL , tissue forceps	35	Tunneling forceps	253
RYDER , DIAMOTE mikro needle holders	61	Tunneling tubes with conical tip	253
HARDTIPS needle holders	69	TUTTLE , lung grasping forceps	35
S			
SAROT , HARDTIPS needle holders	67	V	
SATINSKY , ATRAUMATIC tangential occlusion clamps	114	Valve retractor	219
ATRAUMATIC vascular clamps	174-175	Valve retractor bleyds	219
vascular clamps	171	VANNAS , micro scissors	5
vascular scissors	21	VARADY , dissectors	246
SAUERBRUCH , lung spatulas	235	extractors	246
rib shears	260	spatulas	246
SAUERBRUCH-BRITSCH , rib shears	260	varix instruments	246
SAUERBRUCH-FREY , rib shears	261	Vascular measuring tools	121
		Vascular scissors	20
		Vessel holders	224
		VOLKMANN , bone curettes	259
		retractors	182-183
		VALVULOTOME , dilators	247

	Page	Page
W		
WACHTEL HARDTIPS needle holders	64	
WACHTEL DIAMOTE micro dissecting forceps	41	
WACHTEL DIAMOTE micro tissue forceps	41	
WANGENSTEEN HARDTIPS dissecting forceps	43	
HARDTIPS needle holders	73	
WATSON-CHEYNE dissectors	242-243	
WEBER , ATRAUMATIC aorta anastomosis clamps	135	
WEITLANER , Self-Retaining retractors	197-198	
WERTHEIM , Compression forceps	101	
HARDTIPS dissecting scissors	25	
HARDTIPS needle holders	67	
WERTHEIM-CULLEN , compression forceps	101	
WISTROEM , dissecting and ligature forceps	94	
WILLIAMS , HARDTIPS tissue forceps	45	
organ and tissue grasping forceps	51	
WILLIGER , bone curettes	259	
WITT , sternal puncture needles	258	
Wire cutting pliers	272	
Wire Cutting pliers, with carbid cutter edges	271	
Wire holding forceps	270	
Wire holding pliers, with carbid cutter edges	271	
Wire twistors	270	
Wire cutting pliers, with carbid cutter edges	271	
Wire cutters	272	
WYLIE , ATRAUMATIC vascular clamps	120	
Y		
YANKAUER , cannulaes	177	
YASARGIL , micro scissors	5	
Z		
ZANGER , ATRAUMATIC aorta clamps	134	
ZENKER , dissecting and ligature forceps	95	
fine wound retractors	180	
retractors	189	
ZWEIFEL , HARDTIPS needle holders	71	

Page

Page

Kat. No. Cat. No.	Sayfa Page	Kat. No. Cat. No.	Sayfa Page	Kat. No. Cat. No.	Sayfa Page	Kat. No. Cat. No.	Sayfa Page
A 530.00	121	C 168.36	8	C 513.13	16	C 763.00	24
A 531.00	121	C 168.50	8	C 513.14	16	C 763.01	24
		C 168.51	8	C 513.15	16	C 763.02	24
		C 168.53	8	C 513.30	16	C 764.00	24
B 030.00	2	C 168.54	8	C 513.31	16	C 764.00G	28
B 030.01	2	C 168.56	8	C 513.33	16	C 764.01	24
B 030.02	2	C 169.00	9	C 513.34	16	C 764.01G	28
B 032.00	2	C 169.01	9	C 513.35	16	C 764.02	24
B 034.00	2	C 169.03	9	C 514.01	14	C 764.02G	28
B 040.00	3	C 169.04	9	C 515.00	15	C 766.00	25
B 040.01	3	C 169.06	9	C 515.01	15	C 766.00G	29
B 040.02	3	C 169.09	7	C 516.01	14	C 768.00	24
B 040.03	3	C 169.10	9	C 517.01	14	C 768.00G	29
B 043.00	3	C 169.11	9	C 518.00	15	C 768.01	24
B 043.01	3	C 169.13	9	C 518.01	15	C 768.01G	29
		C 169.14	9	C 518.03	15	C 768.02	24
		C 169.16	9	C 518.04	15	C 768.02G	29
		C 169.18	7	C 518.05	15	C 780.00	27
C 110.00	5	C 169.19	7	C 519.00	15	C 780.02	27
C 112.00	5	C 169.30	9	C 520.00	12	C 780.03	27
C 113.00	5	C 169.31	9	C 521.00	20	C 781.01	27
C 116.00	5	C 169.33	9	C 522.00	12	C 790.00	25
C 117.00	5	C 169.34	9	C 523.00	12	C 798.00	26
C 120.00	5	C 169.36	9	C 526.00	20		
C 121.00	5	C 169.50	9	C 527.00	20		
C 124.00	5	C 169.51	9	C 527.01	20	D 103.00T	46
C 125.00	5	C 169.53	9	C 528.00	20	D 104.00T	46
C 126.00	5	C 169.54	9	C 529.00	20	D 116.01	30
C 134.00	10	C 169.56	9	C 530.00	12	D 117.01	30
C 134.01	10	C 250.00	18	C 540.00	12	D 118.01	30
C 134.03	10	C 251.00	18	C 547.00	17	D 119.01	30
C 134.04	10	C 252.00	18	C 548.00	17	D 120.00	30
C 134.06	10	C 253.00	18	C 569.00	21	D 120.01	30
C 135.00	10	C 310.03	19	C 570.00	21	D 120.02	30
C 135.01	10	C 310.04	19	C 572.00	21	D 121.00	30
C 135.03	10	C 310.05	19	C 573.00	21	D 122.00	30
C 135.04	10	C 311.03	19	C 604.01	258	D 123.00	30
C 135.06	10	C 311.04	19	C 661.00	26	D 125.00	32
C 140.00	4	C 311.05	19	C 662.00	26	D 126.00	32
C 141.00	4	C 313.03	19	C 663.00	26	D 127.00	32
C 142.00	4	C 313.04	19	C 664.00	26	D 128.00	32
C 146.00	11	C 313.05	19	C 665.00	26	D 130.00	31
C 147.00	11	C 314.03	19	C 666.00	26	D 130.01	31
C 148.00	11	C 314.04	19	C 720.03	22	D 130.02	31
C 149.00	11	C 314.05	19	C 721.03	22	D 131.00	31
C 150.00	6	C 315.03	18	C 722.00	22	D 131.01	31
C 151.00	6	C 315.04	18	C 723.03G	29	D 131.02	31
C 152.00	6	C 385.00	18	C 723.03	22	D 146.00	39
C 153.00	6	C 386.00	18	C 725.01	22	D 154.00	39
C 155.00	6	C 502.00	13	C 726.01	22	D 155.00	39
C 157.00	6	C 502.01	13	C 730.00	23	D 198.00	39
C 158.00	6	C 504.00	13	C 730.00G	29	D 199.00	39
C 168.00	8	C 504.01	13	C 738.00	25	D 199.01	39
C 168.01	8	C 504.02	13	C 752.00	23	D 199.03	39
C 168.03	8	C 506.00	13	C 753.00	23	D 199.04	39
C 168.04	8	C 506.01	13	C 753.00G	28	D 204.00T	46
C 168.06	8	C 506.02	13	C 755.00	23	D 207.00	32
C 168.08	7	C 508.00	13	C 755.01	23	D 220.00	34
C 168.09	7	C 508.01	13	C 756.00	23	D 220.00T	48
C 168.10	8	C 510.01	14	C 756.00G	28	D 220.01	34
C 168.11	8	C 511.01	14	C 756.01	23	D 220.01T	48
C 168.13	8	C 512.01	14	C 756.01G	28	D 220.02	34
C 168.14	8	C 513.00	16	C 756.02	23	D 223.00	34
C 168.16	8	C 513.01	16	C 756.02G	28	D 223.00T	48
C 168.18	7	C 513.03	16	C 758.00	24	D 224.00	34
C 168.19	7	C 513.04	16	C 758.00G	28	D 224.00T	48
C 168.30	8	C 513.05	16	C 760.00	25	D 225.02T	48
C 168.31	8	C 513.10	16	C 761.00	25	D 225.03	34
C 168.33	8	C 513.11	16	C 761.01	25	D 225.03T	48
C 168.34	8						

Kat. No. Cat. No.	Sayfa Page	Kat. No. Cat. No.	Sayfa Page	Kat. No. Cat. No.	Sayfa Page	Kat. No. Cat. No.	Sayfa Page
D 225.05	34	D 323.00T	47	D 534.12	44		
D 225.07	34	D 324.00T	47	D 534.20	44	D 675.10	41
D 240.00T	48	D 327.00	32	D 534.21	44		
D 240.01T	48	D 341.00	33	D 534.22	44		
D 240.02T	48	D 341.02	33	D 540.00	45		
D 240.03	34	D 341.03	33	D 540.01	45	E 056.00	50
D 240.03T	48	D 360.02T	47	D 540.02	45	E 057.00	50
D 240.04	34	D 360.03T	47	D 540.03	45	E 058.00	50
D 240.05	34	D 360.04	33	D 540.04	45	E 059.00	50
D 240.05T	48	D 360.04T	47	D 540.10	45	E 082.00	52
D 256.00	36	D 360.05T	47	D 540.11	45	E 083.00	52
D 256.01	36	D 360.06T	47	D 540.12	45	E 086.00	52
D 256.02	36	D 361.00	33	D 540.13	45	E 087.00	52
D 257.00	36	D 361.01	33	D 540.14	45	E 130.00	52
D 257.01	36	D 361.02	33	D 545.00	42	E 130.01	52
D 257.01T	46	D 361.03	33	D 545.01	42	E 143.00	53
D 257.02	36	D 362.00	33	D 549.00	45	E 144.00	53
D 257.02T	46	D 363.00	33	D 553.00	45	E 145.00	53
D 257.03	36	D 363.01	33	D 554.00	45	E 147.01	53
D 257.03T	46	D 370.02	33	D 554.01	45	E 150.00	53
D 257.10	36	D 388.00	35	D 554.02	45	E 150.02	53
D 257.11	36	D 388.01	35	D 558.00	45	E 150.04	53
D 257.12	36	D 388.02	35	D 559.00	45	E 150.06	53
D 257.13	36	D 389.00	35	D 582.00	202	E 150.08	53
D 258.03	36	D 389.01	35	D 601.03	40	E 153.00	51
D 258.04	36	D 390.00	34	D 601.05	40	E 159.00	54
D 259.00	44	D 390.01	34	D 602.03	40	E 170.00	54
D 259.01	44	D 390.02	35	D 602.05	40	E 171.00	54
D 260.00	38	D 396.00	35	D 604.03	40	E 171.01	54
D 260.00T	49	D 398.00	35	D 604.05	40	E 171.03	54
D 260.02	38	D 502.00	42	D 606.01	40	E 172.01	54
D 260.02T	49	D 503.00	42	D 606.03	40	E 174.00	54
D 260.04	38	D 503.02	42	D 606.05	40	E 174.01	54
D 260.06	38	D 504.00	42	D 606.06	40	E 176.00	55
D 262.00	37	D 504.02	42	D 606.08	40	E 177.00	55
D 262.00T	49	D 510.00	43	D 606.13	40	E 178.00	51
D 262.01	37	D 510.01	43	D 608.01	40	E 187.00	55
D 262.01T	49	D 511.00	42	D 608.03	40	E 187.01	55
D 262.02	37	D 512.00	42	D 608.05	40	E 189.00	55
D 262.03	37	D 512.01	42	D 608.06	40	E 199.00	51
D 263.00	37	D 513.00	43	D 608.08	40	E 335.00	256
D 263.00T	49	D 516.00	42	D 609.01T	46	E 336.00	256
D 263.01	37	D 516.01	42	D 609.03T	46	E 430.00	52
D 263.01T	49	D 516.02	42	D 609.05T	46	E 430.01	52
D 263.02	37	D 517.00	43	D 610.01T	46	E 430.02	52
D 263.03	37	D 517.01	43	D 610.03T	46	E 446.00	51
D 264.00	36	D 520.00	43	D 610.05T	46	E 503.00	257
D 264.01	36	D 520.01	43	D 612.00	202	E 503.01	257
D 265.00	37	D 523.00	43	D 615.01	40	E 503.02	257
D 265.00T	49	D 524.00	44	D 615.03	40	E 504.00	257
D 265.01	37	D 524.01	44	D 618.03	40	E 504.01	257
D 265.01T	49	D 524.02	44	D 618.05	40	E 504.02	257
D 265.02	37	D 525.00	44	D 630.02	41	E 505.01	257
D 265.03	37	D 525.01	44	D 630.04	41	E 505.02	257
D 266.00	37	D 525.02	44	D 633.01	41	E 522.00	50
D 266.01	37	D 533.00	44	D 633.03	41	E 522.01	50
D 266.02	37	D 533.01	44	D 633.05	41	E 523.00	50
D 266.03	37	D 533.02	44	D 633.08	41	E 620.00	51-247
D 267.00	36	D 533.10	44	D 635.01	41		
D 267.01	36	D 533.11	44	D 635.03	41	F 112.00	56
D 267.02	36	D 533.12	44	D 635.05	41	F 113.00	56
D 268.00	36	D 533.20	44	D 635.08	41	F 114.00	56
D 268.01	36	D 533.21	44	D 660.03	41	F 115.00	56
D 269.00	36	D 533.22	44	D 661.03	41	F 126.00	56
D 269.01	36	D 534.00	44	D 665.03	41	F 127.00	56
D 269.02	36	D 534.01	44	D 665.05	41	F 132.00	56
D 269.03	36	D 534.02	44	D 673.00	41	F 133.00	56
D 322.00T	47	D 534.10	44	D 673.10	41	F 150.00	57
D 323.00	32	D 534.11	44	D 675.00	41		

Kat. No. Cat. No.	Sayfa Page	Kat. No. Cat. No.	Sayfa Page	Kat. No. Cat. No.	Sayfa Page	Kat. No. Cat. No.	Sayfa Page
F 154.01	57	F 312.04T	60	F 389.01	71		
F 250.00	63	F 312.11T	60	F 389.02	71		
F 251.00	63	F 312.12T	60	F 389.03	71		
F 285.00	63	F 312.14T	60	F 390.00	70		
F 285.01	63	F 312.21T	60	F 390.01	70	G 046.01	81
F 285.02	63	F 312.22T	60	F 391.00	70	G 046.02	81
F 290.00	63	F 312.24T	60	F 391.01	70	G 047.00	81
F 290.01	63	F 312.31T	60	F 394.00	71	G 047.01	81
F 297.00	62	F 312.32T	60	F 394.01	71	G 047.02	81
F 298.00	62	F 312.34T	60	F 396.00	71	G 066.00	255
F 299.00	62	F 317.00	61	F 399.00	71	G 066.05	255
F 301.00	64	F 317.01	61	F 518.04	15	G 190.00	91
F 303.00	64	F 317.02	61	F 529.00	249	G 190.02	91
F 305.00	64	F 317.04	61	F 529.01	249	G 190.04	91
F 305.01	64	F 317.05	61	F 529.02	249	G 190.05	91
F 307.00	60	F 319.00	61	F 529.03	249	G 190.06	91
F 307.04	60	F 325.00	65	F 529.04	249	G 190.07	91
F 310.01	58	F 326.00	65	F 529.05	249	G 190.09	91
F 310.02	58	F 328.00	65	F 529.06	249	G 200.00	84
F 310.03	58	F 333.00	65	F 529.07	249	G 201.00	84
F 310.04	58	F 334.00	72	F 529.08	249	G 204.00	84
F 310.05	58	F 335.00	72	F 529.09	249	G 205.00	84
F 310.06	58	F 336.00	72	F 529.10	249	G 206.00	84
F 310.07	58	F 337.01	72			G 207.00	84
F 310.08	58	F 338.00	67			G 210.00	84
F 310.09	58	F 338.05	67	G 011.01	80	G 211.00	84
F 310.10	58	F 339.01	72	G 011.02	80	G 214.00	84
F 310.21	58	F 344.00	66	G 014.00	78	G 215.00	84
F 310.23	58	F 344.01	66	G 015.00	78	G 218.00	84
F 310.24	58	F 345.00	66	G 015.05	78	G 219.00	84
F 310.25	58	F 345.01	66	G 015.10	78	G 250.00	84
F 310.26	58	F 346.00	66	G 015.15	78	G 251.00	84
F 310.27	58	F 346.01	66	G 015.20	78	G 254.00	84
F 310.28	58	F 346.02	66	G 016.00	78	G 255.00	84
F 310.29	58	F 346.03	66	G 016.05	78	G 260.00	85
F 310.30	58	F 346.04	66	G 016.10	78	G 261.00	85
F 310.31	58	F 347.00	66	G 016.15	78	G 270.00	85
F 310.32	58	F 347.01	66	G 016.20	78	G 271.00	85
F 310.33	58	F 347.02	66	G 018.00	78	G 278.00	85
F 310.34	58	F 350.00	66	G 020.00	80	G 279.00	85
F 310.35	58	F 350.01	66	G 020.01	80	G 280.00	85
F 310.36	60	F 355.00	65	G 021.00	80	G 281.00	85
F 310.37	60	F 355.01	65	G 021.01	80	G 284.00	85
F 310.44	58	F 355.02	65	G 022.00	80	G 285.00	85
F 310.45	58	F 355.03	65	G 023.00	80	G 290.00	86
F 310.46	58	F 355.04	65	G 024.00	80	G 291.00	86
F 310.47	58	F 355.05	65	G 024.01	80	G 294.00	86
F 310.48	58	F 357.00	73	G 024.02	80	G 295.00	86
F 310.49	58	F 357.01	73	G 024.03	80	G 298.00	86
F 310.91T	61	F 360.02	73	G 024.04	80	G 299.00	86
F 310.92T	61	F 363.02	73	G 024.05	80	G 300.00	86
F 311.02	59	F 370.00	67	G 024.06	80	G 301.00	86
F 311.03	59	F 370.01	67	G 026.00	80	G 304.00	86
F 311.04	59	F 370.02	67	G 030.00	80	G 305.00	86
F 311.05	59	F 373.00	67	G 030.01	80	G 308.00	86
F 311.06	59	F 373.02	67	G 035.00	80	G 320.00	87
F 311.12	59	F 380.00	69	G 037.00	81	G 325.00	87
F 311.13	59	F 380.01	69	G 037.01	81	G 425.00	98
F 311.14	59	F 380.02	69	G 037.02	81	G 430.00	88
F 311.15	59	F 380.03	69	G 038.00	81	G 430.01	88
F 311.16	59	F 381.00	69	G 038.01	81	G 430.02	88
F 311.20	59	F 381.01	69	G 038.02	81	G 430.03	88
F 311.21	59	F 381.02	69	G 044.00	81	G 430.04	88
F 311.22	59	F 382.00	68	G 044.01	81	G 431.00	88
F 311.25	59	F 383.00	68	G 044.02	81	G 431.01	88
F 311.27	59	F 384.00	70	G 045.00	81	G 431.02	88
F 312.00	64	F 385.00	69	G 045.01	81	G 431.03	88
F 312.01T	60	F 387.00	70	G 045.02	81	G 431.04	88
F 312.02T	60	F 388.00	68	G 046.00	81	G 440.01	93

Kat. No. Cat. No.	Sayfa Page	Kat. No. Cat. No.	Sayfa Page	Kat. No. Cat. No.	Sayfa Page	Kat. No. Cat. No.	Sayfa Page
G 441.00	93	G 652.04	99	H 204.00	148-173	H 466.00	129
G 448.00	89	G 652.05	99	H 204.01	148-173	H 467.00	134
G 448.01	89	G 653.00	87	H 205.00	173	H 468.00	134
G 448.02	89	G 654.00	94	H 400.00	102	H 469.00	134
G 448.03	89	G 656.00	92	H 401.00	102	H 470.00	134
G 448.04	89	G 656.01	92	H 402.00	102	H 470.01	134
G 448.05	89	G 656.02	92	H 403.00	102	H 470.02	134
G 449.00	89	G 658.00	96	H 406.00	102	H 474.00	130
G 449.01	89	G 658.01	96	H 407.00	102	H 475.00	131
G 449.02	89	G 658.02	96	H 408.00	102	H 476.00	127
G 449.03	89	G 658.03	96	H 409.00	102	H 477.00	127
G 449.04	89	G 658.04	96	H 410.00	102	H 477.01	127
G 449.05	89	G 664.00	96	H 411.00	102	H 477.02	127
G 452.00	98	G 669.00	95	H 412.00	102	H 478.00	130
G 452.01	98	G 669.01	95	H 413.00	102	H 480.00	128
G 452.05	98	G 674.00	100	H 420.00	122	H 481.00	128
G 452.06	98	G 674.01	100	H 420.01	122	H 483.00	141
G 453.00	98	G 680.00	100	H 420.02	122	H 484.00	135
G 458.00	98	G 769.00	92	H 421.00	122	H 485.00	135
G 458.02	98	G 770.00	101	H 421.01	122	H 486.00	136
G 458.05	98	G 771.00	101	H 421.02	122	H 486.01	136
G 458.06	98	G 784.00	97	H 422.00	115	H 487.00	136
G 458.08	98	G 784.02	97	H 423.00	115	H 488.00	132
G 609.00	90	G 784.03	97	H 424.00	117	H 489.00	132
G 610.00	90	G 784.04	97	H 425.00	117	H 500.00	122
G 614.00	90	G 883.00	97	H 425.01	117	H 501.00	122
G 616.00	90	G 884.00	97	H 425.02	117	H 502.00	122
G 616.01	90	G 884.01	97	H 426.00	118	H 503.00	123
G 617.00	90	G 884.02	97	H 427.00	118	H 503.01	123
G 618.00	90	G 888.00	256	H 428.00	118	H 504.00	123
G 618.01	90			H 429.00	118	H 504.01	123
G 618.02	90			H 430.00	116	H 505.00	123
G 618.03	90	H 105.00	83	H 431.00	116	H 505.01	123
G 619.00	92	H 105.02	83	H 432.00	116	H 506.00	124
G 620.00	93	H 105.04	83	H 433.00	116	H 506.01	124
G 620.01	93	H 106.00	83	H 434.00	116	H 506.02	124
G 620.02	93	H 107.00	83	H 435.00	119	H 506.03	124
G 620.03	93	H 107.01	83	H 435.01	119	H 507.00	124
G 620.04	93	H 107.02	83	H 435.02	119	H 507.01	124
G 620.05	93	H 113.00	79	H 440.00	139	H 507.02	124
G 620.06	93	H 113.01	79	H 440.01	139	H 507.03	124
G 640.00	94	H 114.00	79	H 442.00	139	H 510.00	103
G 640.01	94	H 114.01	79	H 442.01	139	H 510.01	103
G 640.02	94	H 115.00	79	H 444.00	139	H 510.02	103
G 640.03	94	H 115.01	79	H 445.00	141	H 511.00	103
G 640.04	94	H 116.00	79	H 446.00	140	H 511.01	103
G 640.05	94	H 116.01	79	H 447.00	140	H 511.02	103
G 640.06	94	H 117.00	79	H 448.00	142	H 520.00	104
G 640.07	94	H 117.01	79	H 448.01	142	H 521.00	104
G 640.08	94	H 120.00	82	H 448.02	142	H 522.00	104
G 640.09	94	H 120.01	82	H 449.00	140	H 523.00	104
G 642.00	93	H 120.02	82	H 450.00	115	H 524.00	104
G 642.01	93	H 120.03	82	H 451.00	115	H 525.00	104
G 642.02	93	H 122.01	82	H 451.01	115	H 530.00	105
G 642.03	93	H 123.00	82	H 452.00	110	H 531.00	105
G 644.00	95	H 123.01	82	H 452.01	110	H 532.00	105
G 644.02	95	H 130.00	81	H 453.00	110	H 533.00	105
G 644.03	95	H 130.01	81	H 454.00	110	H 534.00	108
G 644.04	95	H 131.00	81	H 455.00	110	H 534.01	108
G 644.06	95	H 131.01	81	H 456.00	111	H 535.00	111
G 647.00	99	H 134.00	82	H 457.00	111	H 535.01	111
G 647.01	99	H 136.00	82	H 458.00	111	H 535.03	111
G 648.00	99	H 137.00	82	H 460.00	126	H 535.04	111
G 649.00	87	H 138.01	82	H 460.01	126	H 537.00	121
G 650.00	94	H 139.00	82	H 461.00	126	H 538.00	121
G 651.00	94	H 140.00	82	H 461.01	126	H 540.00	105
G 652.00	99	H 200.00	147	H 465.00	129	H 540.01	105
G 652.01	99	H 200.01	147	H 465.01	129	H 540.02	105
G 652.02	99	H 200.02	147	H 465.02	129	H 540.03	105

Kat. No. Cat. No.	Sayfa Page	Kat. No. Cat. No.	Sayfa Page	Kat. No. Cat. No.	Sayfa Page	Kat. No. Cat. No.	Sayfa Page
H 541.00	120	H 603.12	165	H 672.01	172	J 215.26	176
H 542.00	120	H 604.00	150	H 674.00	143	J 215.28	176
H 543.00	120	H 605.00	150	H 674.01	143	J 215.51	176
H 545.00	106	H 606.00	150	H 675.00	144	J 215.52	176
H 545.01	106	H 607.00	150	H 677.00	145	J 215.53	176
H 546.00	108	H 608.00	151	H 677.01	145	J 215.54	176
H 547.00	108	H 609.00	151	H 677.02	145	J 215.56	176
H 548.00	108	H 610.00	151	H 677.03	145	J 215.58	176
H 549.00	108	H 611.00	151	H 679.00	146	J 215.81	176
H 549.01	108	H 612.00	151	H 679.01	146	J 215.82	176
H 549.02	108	H 613.00	151	H 680.00	164	J 215.83	176
H 549.03	108	H 614.00	151	H 681.00	164	J 215.84	176
H 550.00	106	H 616.00	152	H 682.00	164	J 215.86	176
H 551.00	106	H 616.01	152	H 683.00	164	J 215.88	176
H 552.00	106	H 616.03	152	H 684.00	164	J 220.02	176
H 554.00	107	H 616.04	152	H 700.00	166	J 222.00	176
H 554.01	107	H 617.00	152	H 701.00	166	J 222.01	176
H 554.02	107	H 617.01	152	H 702.00	166	J 259.00	254
H 556.00	107	H 617.03	152	H 705.00	166	J 259.01	254
H 560.00	109	H 617.04	152	H 706.00	167	J 259.02	254
H 561.00	109	H 620.00	153	H 707.00	167	J 259.03	254
H 562.00	107	H 620.01	153	H 709.00	167	J 259.04	254
H 563.00	109	H 621.00	153	H 710.00	168	J 259.11	254
H 564.00	112	H 621.01	153	H 711.00	168	J 259.12	254
H 564.01	112	H 621.02	153	H 713.00	169	J 259.13	254
H 566.00	112	H 630.00	154	H 714.00	169	J 259.14	254
H 567.00	112	H 630.01	154	H 720.00	174	J 259.31	254
H 568.00	112	H 630.02	154	H 721.00	174	J 259.32	254
H 569.00	112	H 631.00	157	H 723.00	175	J 259.33	254
H 570.00	113	H 631.01	157	H 724.00	175	J 259.34	254
H 570.01	113	H 631.02	157	H 755.00	161	J 259.41	254
H 570.02	113	H 631.03	157	H 756.00	161	J 259.42	254
H 570.03	113	H 632.00	154	H 757.00	162	J 259.43	254
H 570.04	113	H 633.00	154	H 758.00	160	J 259.44	254
H 571.00	113	H 634.00	159	H 758.01	160	J 259.51	254
H 571.01	113	H 634.01	159	H 759.00	160	J 259.52	254
H 571.02	113	H 635.00	159	H 759.01	160	J 259.53	254
H 572.00	138	H 636.00	159	H 759.02	160	J 259.54	254
H 572.02	138	H 638.00	159	H 770.00	149	J 301.00	177
H 573.00	137	H 640.00	163	H 770.01	149	J 302.00	177
H 574.00	137	H 641.00	163	H 771.00	149	J 303.00	177
H 576.00	133	H 642.00	163	H 771.01	149	J 304.00	177
H 577.00	133	H 643.00	155	H 772.00	149	J 306.00	177
H 578.00	114	H 644.00	155	H 772.01	149	J 307.00	177
H 578.01	114	H 645.00	156	H 773.00	149	J 307.01	177
H 578.02	114	H 645.01	156	H 773.01	149	J 307.02	177
H 578.03	114	H 645.02	156	H 774.00	149	J 307.03	177
H 578.04	114	H 645.03	156	H 774.01	149	J 308.00	177
H 580.00	125	H 645.04	156	H 900.01	172	J 309.00	254
H 580.01	125	H 647.00	158	H 901.01	172	J 500.00	246
H 580.02	125	H 650.00	163	H 910.00	173	J 500.01	246
H 580.03	125	H 652.00	163	H 911.01	173	J 500.03	246
H 581.00	125	H 653.00	160	H 912.01	173	J 500.04	246
H 581.01	125	H 653.01	160			J 500.05	246
H 581.02	125	H 654.00	160			J 500.06	246
H 581.03	125	H 654.01	160	J 212.00	176	J 500.07	246
H 583.00	119	H 655.00	160	J 212.01	176	J 500.08	246
H 589.00	170	H 656.00	160	J 212.02	176	J 500.10	246
H 600.00	150	H 660.00	170	J 212.03	176	J 500.11	246
H 601.00	150	H 661.00	171	J 215.01	176	J 500.12	246
H 602.00	150	H 661.01	171	J 215.02	176	J 502.00	246
H 603.00	165	H 661.02	171	J 215.03	176	J 502.01	246
H 603.01	165	H 665.00	171	J 215.04	176	J 502.03	246
H 603.02	165	H 666.00	170	J 215.06	176	J 502.04	246
H 603.03	165	H 667.00	170	J 215.08	176	J 502.05	246
H 603.05	165	H 668.00	120	J 215.21	176	J 504.02	247
H 603.07	165	H 668.01	120	J 215.22	176	J 504.03	247
H 603.08	165	H 670.01	172	J 215.23	176	J 504.04	247
H 603.11	165	H 671.01	172	J 215.24	176	J 504.05	247

Kat. No. Cat. No.	Sayfa Page	Kat. No. Cat. No.	Sayfa Page	Kat. No. Cat. No.	Sayfa Page	Kat. No. Cat. No.	Sayfa Page
J 506.02	247	J 515.03	248	K 110.01	179	K 452.10	184
J 506.03	247	J 515.04	248	K 110.02	179	K 454.00	185
J 506.04	247	J 515.05	248	K 110.03	179	K 454.01	185
J 506.05	247	J 515.06	248	K 127.00	178	K 605.04	188
J 508.00	248	J 515.07	248	K 130.00	178	K 605.05	188
J 508.01	248	J 515.08	248	K 131.00	178	K 605.06	188
J 508.02	248	J 515.09	248	K 135.00	178	K 608.01	188
J 508.03	248	J 515.11	248	K 138.00	178	K 608.02	188
J 508.04	248	J 515.13	248	K 138.01	178	K 610.01	186
J 508.05	248	J 516.00	248	K 140.00	179	K 612.01	186
J 508.06	248	J 516.01	248	K 141.00	178	K 614.01	186
J 508.07	248	J 516.02	248	K 142.00	179	K 614.02	186
J 510.02	247	J 516.03	248	K 152.00	180	K 616.00	189
J 510.03	247	J 516.04	248	K 153.00	180	K 616.02	189
J 510.04	247	J 516.05	248	K 190.00	180	K 616.04	189
J 510.05	247	J 516.06	248	K 196.00	180	K 616.06	189
J 510.06	247	J 516.07	248	K 259.00	182	K 620.00	230
J 510.07	247	J 516.08	248	K 262.00	180	K 620.01	230
J 510.08	247	J 516.09	248	K 262.01	180	K 621.00	230
J 510.09	247	J 516.11	248	K 262.02	180	K 625.02	233
J 510.10	247	J 516.13	248	K 262.03	180	K 625.05	233
J 510.11	247	J 517.00	247	K 262.04	180	K 628.02	233
J 510.12	247	J 517.01	247	K 263.00	181	K 630.00	234
J 510.13	247	J 517.02	247	K 263.01	181	K 630.01	234
J 510.14	247	J 517.03	247	K 266.00	181	K 630.02	234
J 510.15	247	J 518.01A	251	K 267.00	181	K 631.00	235
J 510.17	247	J 518.02A	251	K 267.01	181	K 635.02	231
J 511.02	247	J 518.03A	251	K 273.00	181	K 637.01	232
J 511.03	247	J 518.04A	251	K 273.01	181	K 637.03	232
J 511.04	247	J 518.05A	251	K 273.02	181	K 646.00	236
J 511.05	247	J 518.06A	251	K 273.03	181	K 646.01	236
J 511.06	247	J 519.01A	251	K 273.04	181	K 647.00	236
J 511.07	247	J 519.02A	251	K 273.05	181	K 647.01	236
J 511.08	247	J 519.03A	251	K 273.06	181	K 647.02	236
J 511.09	247	J 519.04A	251	K 273.07	181	K 647.03	236
J 511.10	247	J 519.05A	251	K 274.00	181	K 647.04	236
J 511.11	247	J 519.06A	251	K 274.01	181	K 647.05	236
J 511.12	247	J 520.01	250	K 274.02	181	K 648.00	236
J 511.13	247	J 520.02	250	K 276.00	181	K 648.01	236
J 511.14	247	J 520.03	250	K 276.01	181	K 648.02	236
J 511.15	247	J 520.04	250	K 325.00	182	K 648.03	236
J 511.17	247	J 525.01	249	K 325.01	182	K 648.04	236
J 513.00	248	J 525.02	249	K 325.02	182	K 648.05	236
J 513.01	248	J 525.03	249	K 325.03	182	K 649.00	236
J 513.02	248	J 525.04	249	K 404.00	183	K 650.00	236
J 513.03	248	J 525.05	249	K 405.00	183	K 650.01	236
J 513.04	248	J 525.06	249	K 406.00	183	K 650.02	236
J 513.05	248	J 525.07	249	K 408.00	183	K 652.00	237
J 513.06	248	J 525.08	249	K 430.02	182	K 652.01	237
J 513.07	248	J 525.09	249	K 432.02	182	K 652.02	237
J 513.08	248	J 525.12	249	K 432.03	182	K 653.00	237
J 513.09	248	J 530.00	251	K 450.01	184	K 654.00	237
J 513.11	248	J 530.01	250	K 450.02	184	K 655.00	237
J 513.13	248	J 530.02	250	K 450.03	184	K 659.00	185
J 514.00	248	J 530.03	251	K 451.01	184	K 660.01	190
J 514.01	248	J 530.04	251	K 451.02	184	K 660.02	190
J 514.02	248	J 530.05	250	K 451.03	184	K 660.03	190
J 514.03	248	J 530.06	250	K 451.04	184	K 660.04	191
J 514.04	248	J 600.00	177	K 451.05	184	K 660.05	191
J 514.05	248	J 710.00	258	K 451.06	184	K 660.06	192
J 514.06	248	J 710.02	258	K 452.01	184	K 660.07	192
J 514.07	248			K 452.02	184	K 660.08	193
J 514.08	248			K 452.03	184	K 660.09	193
J 514.09	248	K 103.00	178	K 452.04	184	K 668.04	194
J 514.11	248	K 104.00	178	K 452.05	184	K 668.05	194
J 514.13	248	K 104.01	178	K 452.06	184	K 668.07	195
J 515.00	248	K 106.00	178	K 452.07	184	K 668.08	195
J 515.01	248	K 109.00	180	K 452.08	184	K 676.02	185
J 515.02	248	K 110.00	179	K 452.09	184	K 676.04	185

Kat. No. Cat. No.	Sayfa Page	Kat. No. Cat. No.	Sayfa Page	Kat. No. Cat. No.	Sayfa Page	Kat. No. Cat. No.	Sayfa Page
K 694.00	238	L 810.00	204	L 848.00	223-227	L 880.01A	212
K 694.01	238	L 811.00	204	L 849.01	220-223-227	L 880.02A	212
K 694.02	238	L 812.00	207	L 849.02	227	L 880.05A	212
K 694.03	238	L 812.01	207	L 849.03	222-227	L 880.06A	212
K 694.04	238	L 812.05	207	L 849.05	227	L 880.07A	212
K 694.05	238	L 812.10	207	L 850.00	228	L 880.10A	212
K 695.00	239	L 814.00	206	L 851.00	228	L 880.11A	212
K 695.00P	240	L 814.01	206	L 851.01	228	L 881.00A	213
K 695.01	239	L 814.05	206	L 851.02	228	L 881.01A	213
K 695.01P	240	L 814.06	206	L 860.00	220	L 881.04A	213
K 695.02	239	L 814.07	206	L 860.05	220	L 882.00A	214
K 695.02P	240	L 815.00	208	L 860.06	220	L 882.01A	214
K 696.00	239	L 815.01	209	L 860.07	220	L 883.00A	214
K 696.01	239	L 815.05	208	L 861.00	220	L 884.00A	214
K 696.02	239	L 815.06	208	L 861.05	220	L 885.00A	215
K 696.02P	241	L 815.07	208	L 862.00	220	L 903.00	202
K 697.02	239	L 815.08	208	L 862.05	220	L 903.01	202
K 697.02P	241	L 815.09	208	L 862.07	220	L 903.03T	202
K 700.01	187	L 816.00	217	L 862.08	220	L 903.04T	202
K 700.02	187	L 816.01	217	L 864.00	219	L 905.00	203
K 700.03	187	L 816.05	217	L 864.05	219	L 905.01	203
K 702.02	188	L 816.06	217	L 864.06	219	L 905.03	203
K 702.03	188	L 816.07	217	L 864.07	219	L 905.04	203
L 005.00	196	L 817.00	217	L 864.08	219	L 906.00	203
L 005.01	196	L 818.00	217	L 864.09	219	L 906.01	203
L 009.00	196	L 818.01	217	L 864.11	219	L 906.03	203
L 080.00	196	L 818.05	217	L 864.13	219	L 906.04	203
L 088.00	196	L 818.06	217	L 864.14	219	L 906.05	203
L 088.01	196	L 819.00	218	L 864.15	219		
L 089.00	196	L 820.00	206	L 865.00	222	M 102.00	242
L 093.00	196	L 820.01	206	L 865.05	222	M 102.01	242
L 290.00	256	L 821.00	216	L 866.00	222	M 115.01	242
L 301.00	197	L 823.00	216	L 866.01	221-222	M 116.00	242
L 304.00	197	L 824.00	216	L 866.05	221	M 116.01	242
L 305.00	197	L 825.00	218	L 866.06	221	M 120.02	242
L 312.00	197	L 825.01	218	L 866.07	221-222	M 125.01	242
L 313.00	197	L 825.05	218	L 866.08	221	M 150.01	242
L 330.02	197	L 827.00	215	L 866.09	221	M 156.01	242
L 331.02	197	L 828.02	205	L 866.10	221	M 156.02	242
L 353.01	198	L 828.04	205	L 866.20	221	M 158.01	242
L 353.02	198	L 830.01	209	L 866.23	221	M 168.01	243
L 353.03	198	L 830.02	209	L 866.25	221	M 168.03	243
L 354.01	198	L 830.05	209	L 867.00	223	M 237.10	243
L 354.02	198	L 830.06	209	L 867.05	223	M 238.00	243
L 354.03	198	L 831.00	223-224	L 868.00	223	M 265.01	244
L 375.02	199	L 832.00	222-223-224	L 868.05	223	M 278.01	244
L 377.02	199	L 833.00	222-223-224	L 869.00	229	M 278.02	244
L 402.00	198	L 833.02	222-223-224	L 869.01	229	M 278.03	244
L 402.03	198	L 834.00	220-222-223-225	L 869.05	229	M 278.04	244
L 402.05	198	L 835.00	225	L 869.06	229	M 278.05	244
L 403.00	198	L 836.00	225	L 870.00	229	M 285.00	244
L 403.03	198	L 837.00	225	L 870.03	229	M 289.01	244
L 403.05	198	L 838.00	226	L 870.05	229	M 289.02	244
L 403.06	198	L 839.00	220-222-226	L 875.00A	210	M 289.03	244
L 522.00	200	L 840.00	220-222-226	L 875.02A	210	M 289.04	244
L 800.00	200	L 840.01	222-226	L 875.05A	210	M 289.05	244
L 800.02	200	L 840.02	222-226	L 875.07A	210	M 290.01	245
L 800.05	200	L 841.00	223-226	L 875.10A	210	M 290.02	245
L 800.06	200	L 841.01	223-226	L 875.13A	210	M 291.01	245
L 800.07	200	L 841.02	223-226	L 876.00A	211	M 291.02	245
L 800.08	200	L 842.00	223-226	L 877.00A	211	M 292.01	245
L 800.09	200	L 842.01	222-226	L 878.00A	211	M 293.01	245
L 802.00	200	L 842.02	223-226	L 878.01A	211	M 580.00	246
L 803.00	201	L 843.00	223-226	L 878.02A	211	M 580.01	246
L 804.00	201	L 843.01	222-223-226	L 879.00A	212	M 580.02	246
L 805.00	216	L 843.02	223-226	L 879.05A	212	M 580.05	246
L 806.00	201	L 845.00	227	L 879.06A	212	M 580.06	246
L 807.00	201	L 846.00	222-227	L 879.07A	212	M 580.07	246
L 808.00	202	L 847.00	222-227	L 880.00A	212		

Kat. No. Cat. No.	Sayfa Page	Kat. No. Cat. No.	Sayfa Page	Kat. No. Cat. No.	Sayfa Page	Kat. No. Cat. No.	Sayfa Page
M 582.00	243	P 379.01	269	S 010.00	74-77		
M 582.01	243	P 500.01	260	S 010.01	77		
M 582.02	243	P 500.02	260	S 011.00	74		
M 582.03	243	P 501.00	260	S 012.00	74		
M 598.00	258	P 502.01	261	S 013.00	74		
		P 505.00	258	S 014.00	74		
		P 510.00	261	S 015.00	74		
N 176.01	259	P 511.00	261	S 020.00	74		
N 176.02	259	P 513.01	261	S 021.00	74		
N 176.03	259	P 515.00	260	S 022.00	74		
N 176.04	259	P 520.01	261	S 023.00	74		
N 176.05	259	P 522.01	261	S 024.00	77		
N 176.06	259	P 610.00	271	S 025.00	75		
N 176.07	259	P 611.00	270	S 026.00	75		
N 177.01	259	P 612.00	270	S 030.00	74		
N 177.02	259	P 613.00	270	S 032.00	77		
N 177.03	259	P 614.00	270	S 034.00	77		
N 177.04	259	P 615.00	270	S 035.00	77		
N 177.05	259	P 616.00	270				
N 177.06	259	P 617.00	270				
N 177.07	259	P 632.00	271	T 080.00	179		
N 179.01	259	P 639.00	271	T 450.00	258		
N 179.02	259	P 640.00	272	T 850.00	260		
N 179.03	259	P 641.00	272	T 852.00	260		
N 179.04	259	P 643.00	272	T 852.01	260		
N 179.05	259	P 645.00	272	T 854.01	260		
N 179.06	259	P 649.00	271	T 856.00	260		
N 179.07	259	R 209.00	254				
N 179.08	259	R 209.01	254				
N 179.09	259	R 209.02	254				
N 179.10	259	R 209.03	254				
N 180.01	259	R 209.10	254				
N 180.02	259	R 209.11	254				
		R 209.12	254				
		R 209.13	254				
P 135.00	262	R 331.01	273				
P 136.00	262	R 331.02	273				
P 150.00	262	R 375.00	273				
P 151.00	262	R 375.01	273				
P 152.00	262	R 375.02	273				
P 310.01	263	R 375.03	273				
P 310.02	263	R 379.00	273				
P 315.01	263	R 379.01	273				
P 320.01	264	R 379.02	273				
P 321.01	264	R 410.00	273				
P 325.01	264	R 850.01	252				
P 326.01	264	R 852.03	253				
P 330.00	265	R 852.04	253				
P 333.01	265	R 852.05	253				
P 335.01	265	R 852.13	253				
P 350.00	266	R 852.14	253				
P 350.01	266	R 852.15	253				
P 358.01	266	R 852.23	253				
P 358.02	266	R 852.24	253				
P 358.03	266	R 852.25	253				
P 358.04	266	R 855.33	253				
P 359.02	266	R 855.34	253				
P 359.03	266	R 855.35	253				
P 359.04	266	R 860.01	252				
P 365.00	267	R 861.01	252				
P 366.00	267						
P 367.00	267						
P 368.00	267	S 001.00	76				
P 370.00	267	S 002.00	76				
P 371.00	267	S 003.00	76				
P 375.01	268	S 005.00	76				
P 376.01	268	S 005.01	76				
P 377.01	268	S 005.05	76				
P 378.01	269	S 005.06	76				

NOT: _____

NOT:

NOT: _____

NOT: _____



TIBBİ ALETLER SANAYİ VE TİCARET A.Ş

Factory and Head Office

Organize Sanayi Bölgesi 55300 Samsun / TURKEY
Phone : +90(362)266 70 00 Fax : +90(362)266 70 05

www.bahadir.com.tr

e-mail : info@bahadir.com.tr