



JİNEKOLOJİ
GYNAECOLOGY





**JİNEKOLOJİ
GYNECOLOGY**

BAHADIR TIBBİ ALETLER SANAYİ VE TİCARET A.Ş.
BAHADIR MEDICAL EQUIPMENT INDUSTRY AND TRADE CO.
Organize Sanayi 55 300 / KUTLUKENT / SAMSUN / TURKEY
Tel : 90 (362) 266 70 01 (Pbx) Fax : 90 (362) 266 70 05
www.bahadir.com.tr E-mail : info@bahadir.com.tr



BAHADIR Tibbi Aletler 1983 yılında Samsun'da kurulmuştur. Üretim kalitesinin yüksekliği, satış ve servis organizasyonu ile bu alanda lider olarak tanınmaktadır.

Kataloğumuzda yer alan ürünlerimiz, ham malzemeden son ürün haline gelinceye kadar bilgi, beceri, deneyimlerimiz ve yüksek teknolojiyle desteklenerek titiz bir kalite denetim sistemi içerisinde üretilmiştir. Aksi belirtilmedikçe kataloğumuzda yer alan ürünlerimiz, uygun spesifikteki paslanmaz çelikten üretilmiş, çizimler ve resimler gerçek boyutlarında verilmiştir.

Gectiğimiz yıllar boyunca tıp camiasından gördüğümüz yakın ilgi, güven ve destek sayesinde bugün cerrahi branşların hemen hepsi için alet üretiyoruz. Ürünlerimiz uluslararası pazarlarda haklı bir üne kavuşmuştur.

Göz Cerrahi üretim programımızı içeren bu kataloğumuz ile birlikte K.B.B ve Plastik Cerrahi, Endoskopi, Steril Konteyner Sistemleri kataloglarımız ve cerrahi branşlara göre hazırlanmış kataloglarımız mevcuttur. Kataloglarımız gelişen tıbbi teknikler ve yaklaşımlar ile ortaya çıkan yeni dizayn alet ve setleri de kapsayacak şekilde titiz bir çalışma ile hazırlanmıştır.

Sizlere sunacaklarımız bu kataloglarla sınırlı değildir. Alet ve setlerinizin bakım ve onarımı, mevcut dizaynlar üzerinde değişiklik istekleriniz, yeni cerrahi teknikler için geliştireceğiniz aletlerin üretimi ve bu katalogta yer almayan diğer ürünler için teknik olanaklarımız, bilgi ve deneyimlerimiz daima emrinizde olacaktır.

Tıp camiasına ve bu katalogun hazırlanmasında emeği geçenlere öneri ve eleştirileri ile bizleri yönlendirenlere teşekkür ederiz.



Being established in 1983 in Samsun / Turkey, BAHADIR Medical Equipment has been recognized as a leader in the production of Surgical Instruments for its exceptional quality products, sales and wide range of service organization.

All instruments pictured in this catalog are the products of consistent craftsmanship combined with advanced production techniques and traditional skills acquired over the years. Forging to crafting-utmost care has been taken to ensure accuracy in every stage of production and our strive continues to achieve highest standards and top quality products. Instruments displayed here are stainless steel and they are shown in full scale unless otherwise indicated.

BAHADIR enjoys a significant reputation of manufacturing instruments for all surgical branches, thanks to close cooperation and support from our medical society which made them competitive international markets.

In addition to this catalog, we also have supplemental catalogues for ENT, Edoscopy and Steril Container System available on request. We are, however, conscious of the fact that this catalog remains insufficient to cover all the facilities and novelties we can offer. It is our endeavor to develop new products as new technology and demands for new procedures become known.

We will always be at your disposal with our technical facilities knowledge and vast experience for your specific needs including refurbishment of your instruments and sets, modification of present patterns, custom-made production on entirely new designs developed to your surgical techniques as well as any other product which is not displayed here.

BAHADIR would like to thank all those who have co-operated in the compilation of this catalog.





GARANTİ / GUARANTEE

BAHADIR tescilli markasını ve logosunu taşıyan ürünler malzeme ve işçilik açısından beş yıl garantilidir. Bu süre içinde normal kullanım koşullarında arızalanan aletler ücretsiz olarak onarılacak yada yenisi ile değiştirilecektir.

All products carrying the registered trademark and logo of BAHADIR are guaranteed for five years in respect of material and workmanship in normal use. We will replace or repair any damaged instrument free of charge during this period.

Her hakkı saklıdır.



Bu kataloğun hiçbir bölümü BAHADIR'ın yazılı izni olmadan kopya edilemez, yayınlanamaz.

All rights reserved.

No part of this catalog may be reproduced in any form without written permission from BAHADIR.

Grafik / Graphic : BAHADIR

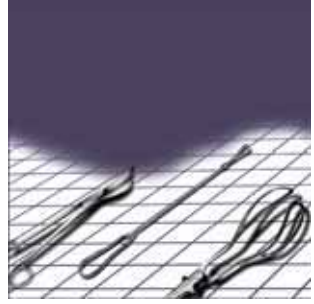
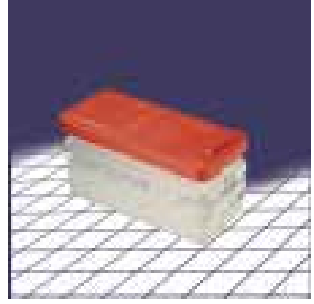
Baskı/Print : GÜVEN OFSET - SAMSUN

	Sayfa Page	
Aletler Instruments	1-206	
Steril Konteyner Sistemleri Steril Container Systems	207-230	
Setler Sets	231-252	
Alfabetik İndex Alphabetic Index	253-265	



INSTRUMENTS

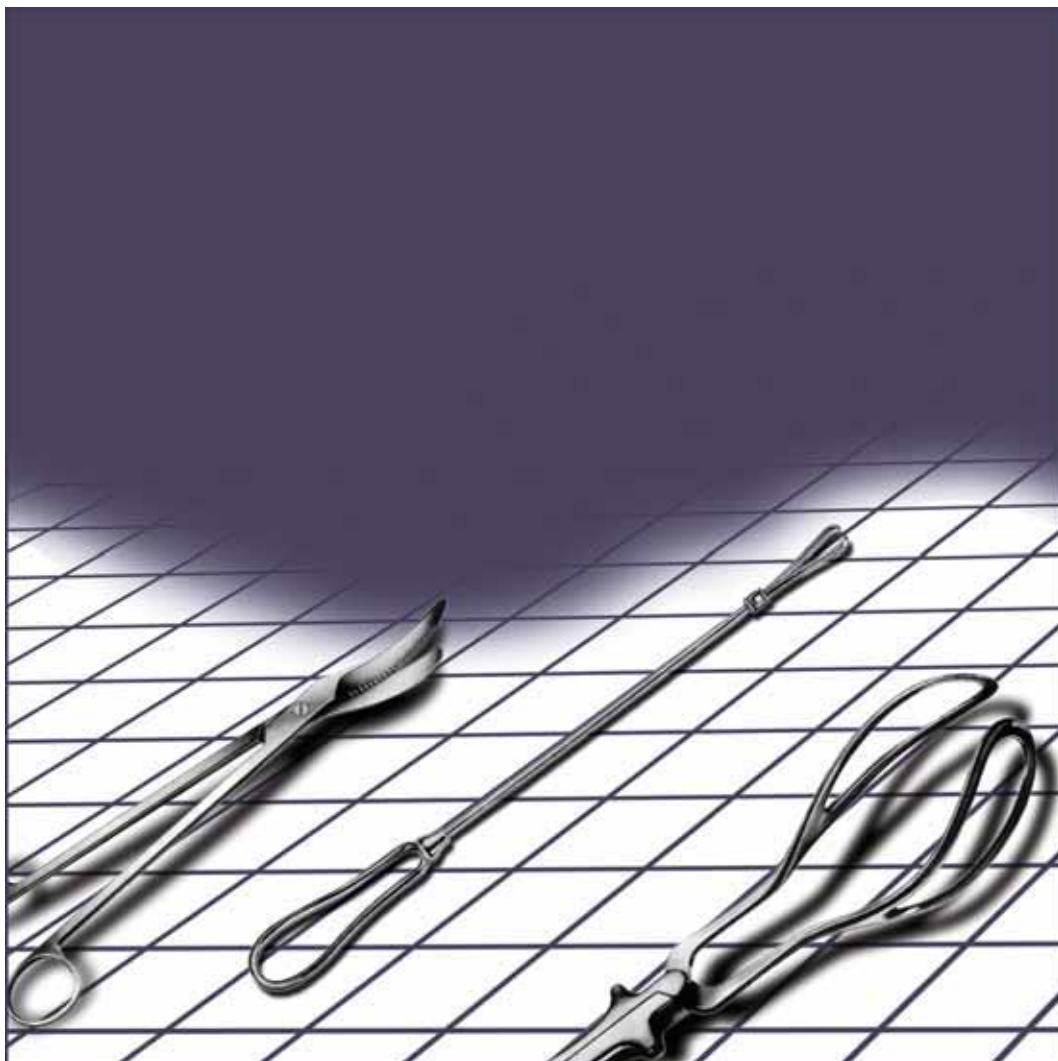



1/2

PINARD
A 202.00
Aliminyum/Aluminium
15.5 cm



1/2

A 201.00
Ağaç/Wooden
14.5 cm



1/2

DE LEE
A 610.01
Aliminyum/Aluminium
Ölçüm cm, inç/Measuring cm, inch
15.5 cm



1/3

MARTIN
A 620.01
Ölçüm cm/Measuring cm
36 cm



1/3

SCHNIEDER
A 620.03
Ölçüm cm/Measuring cm
36 cm



G 884.00
15 cm

G 884.01
18 cm

G 884.02
20 cm

G 884.00 - G 884.02

Tüp klempi, ağızları tırtıllı

Tubing clamp forceps, serrated jaws



1/2

G 883.00

Tüp klempi, ağızları tırtılsız

Tubing clamp forceps smooth jaws

16.5 cm



1/2

SAUERBRUCH

G 803.00

Tutma pens, tampon ve çamaşırlar için

Pick-up forceps for tampons and dressings
55 cm





1/1
ULRICH
B 110.01
22.5 cm

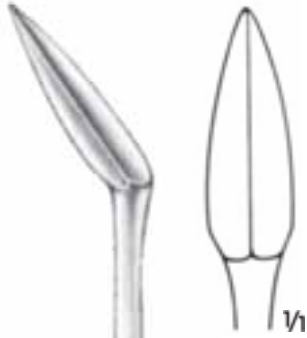

1/1
B 112.00
23 cm



1/1
AYRE
B 113.00
23.5 cm

3 No



1/1
B 030.00
13.5 cm



1/1
B 030.01
13.5 cm



1/1
B 030.02
21.5 cm



1/1
B 034.00
22.5 cm



1/1
B 034.01
22.5 cm

4 No



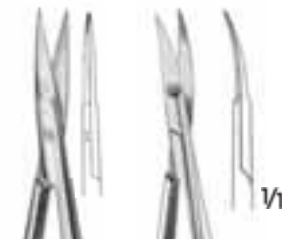

C 112.00 Düz/Straight
C 113.00 Eğri/Curved

C 112.00 - C 113.00
16 cm



C 116.00 Düz/Straight
C 117.00 Eğri/Curved

VANNAS
C 116.00 - C 117.00
16 cm



C 120.00 Düz/Straight
C 121.00 Eğri/Curved

MILLESİ
C 120.00 - C 121.00
Çift ağız tırtıllı/Both jaws serrated
16 cm



C 140.00 Düz/Straight
C 141.00 Eğri/Curved
C 142.00 Eğri/Curved

C 140.00 - C 142.00
14.5 cm



YASARGIL
C 124.00 Düz/Straight
JACOBSON
C 125.00 Eğri/Curved

C 124.00 - C 125.00
18.5 cm



C 145.00
23 cm



C 314.01 - C 314.04



C 314.01
11.5 cm



C 314.02
13 cm



C 314.03
14.5 cm



C 314.04
15 cm



C 315.01 - C 315.04



C 315.01
11.5 cm



C 315.02
13 cm



C 315.03
14.5 cm



C 315.04
15 cm



C 310.01
11.5 cm



C 310.02
13 cm



C 310.03
14.5 cm



C 310.04
15 cm

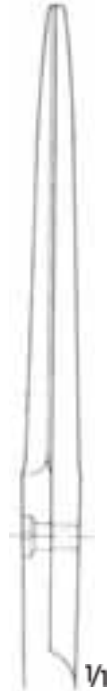

C 310.05
16.5 cm

C 310.01 - C 310.05
Sivri/Künt, Düz
Sharp/Blunt, Straight



C 312.02
13 cm



C 312.03
14.5 cm



C 312.04
15 cm



C 312.05
16.5 cm

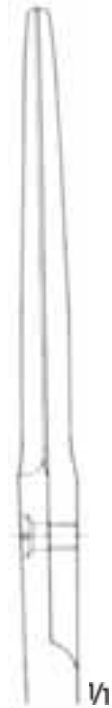

C 312.06
17.5 cm

C 312.02 - C 312.06
Künt/Blunt
Düz/ Straight

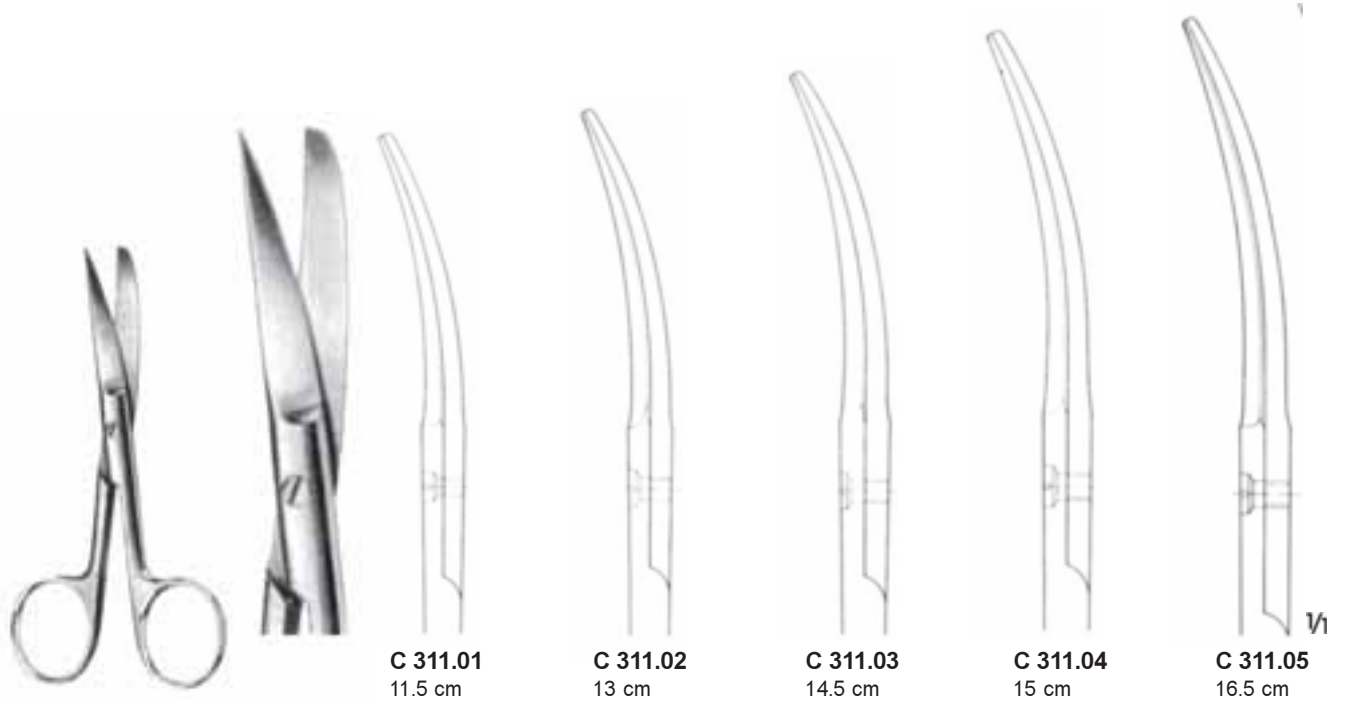

C 311.01 - C 311.05
Sivri/Künt, Eğri
Sharp/Blunt, Curved

C 311.01
11.5 cm

C 311.02
13 cm

C 311.03
14.5 cm

C 311.04
15 cm

C 311.05
16.5 cm

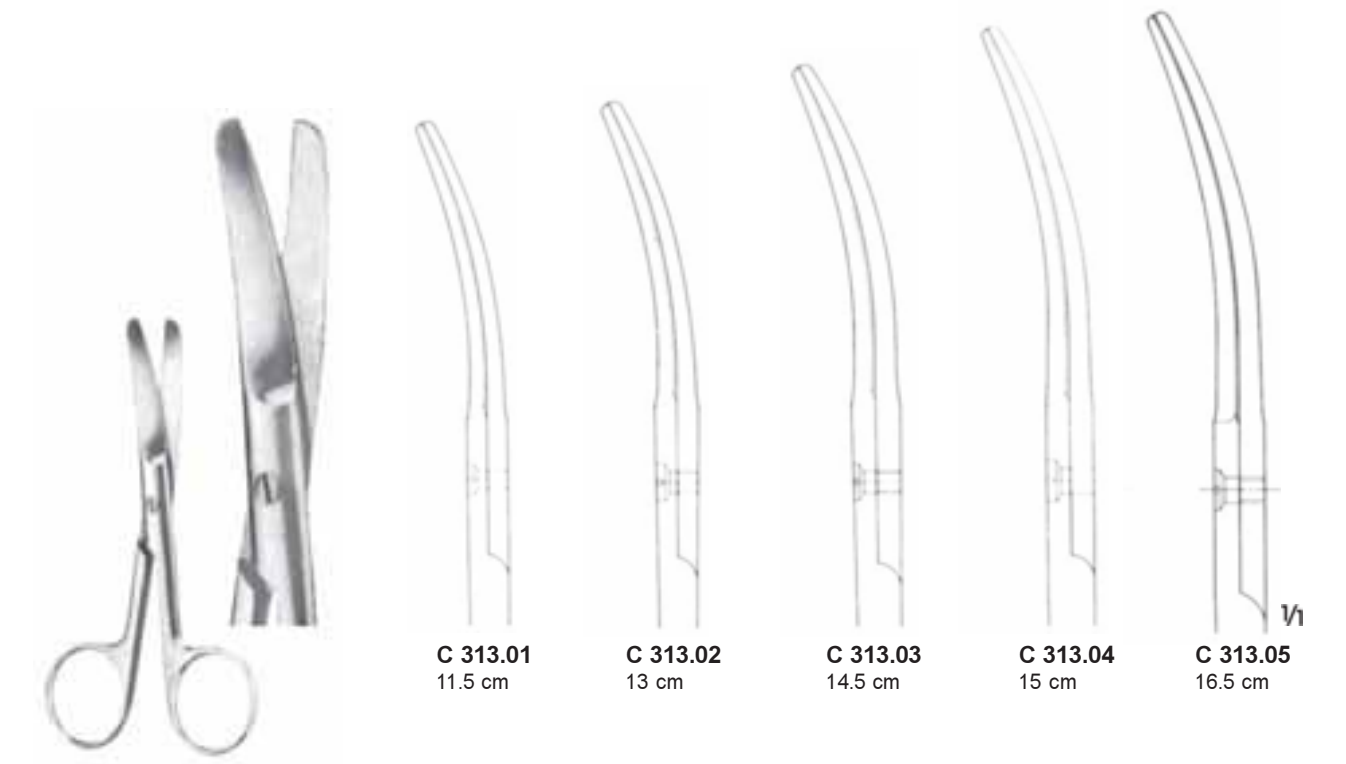

COOPER
C 313.01 - C 313.05
Künt/Blunt
Eğri/Curved

C 313.01
11.5 cm

C 313.02
13 cm

C 313.03
14.5 cm

C 313.04
15 cm

C 313.05
16.5 cm



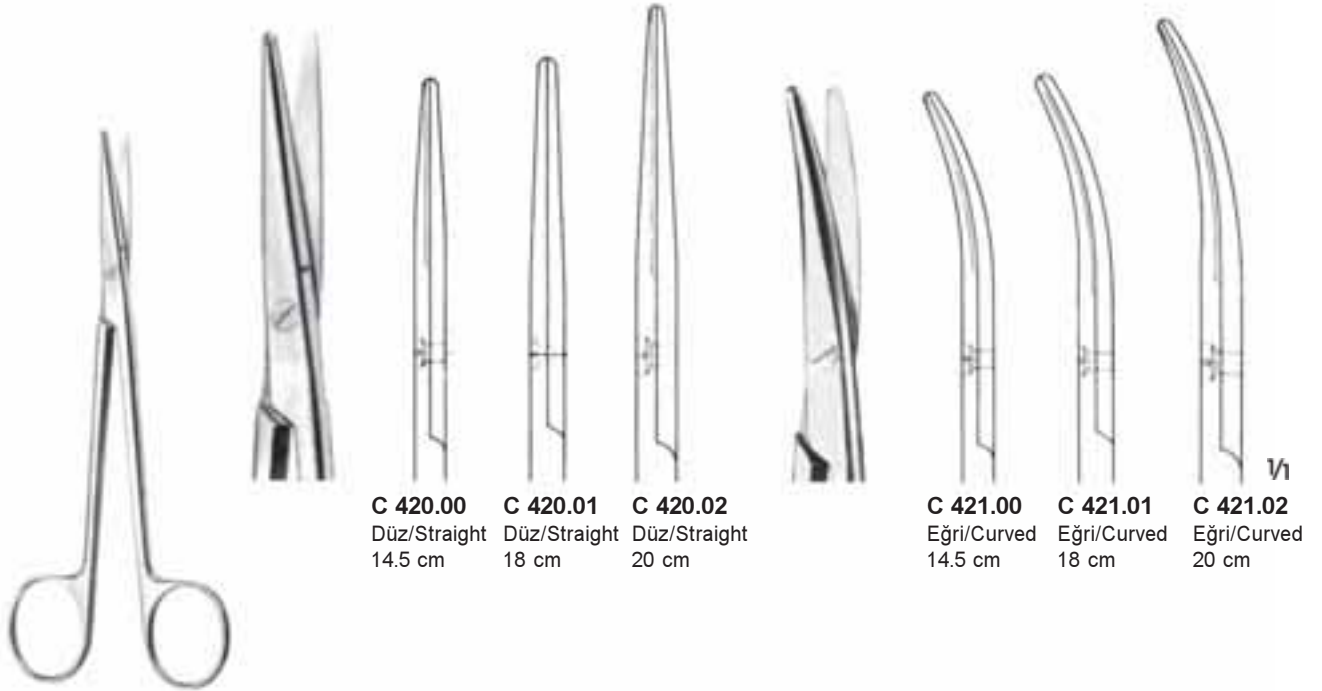

C 420.00 Düz/Straight 14.5 cm
C 420.01 Düz/Straight 18 cm
C 420.02 Düz/Straight 20 cm

C 421.00 Eğri/Curved 14.5 cm
C 421.01 Eğri/Curved 18 cm
C 421.02 Eğri/Curved 20 cm

METZENBAUM
C 420.00 - C 421.02

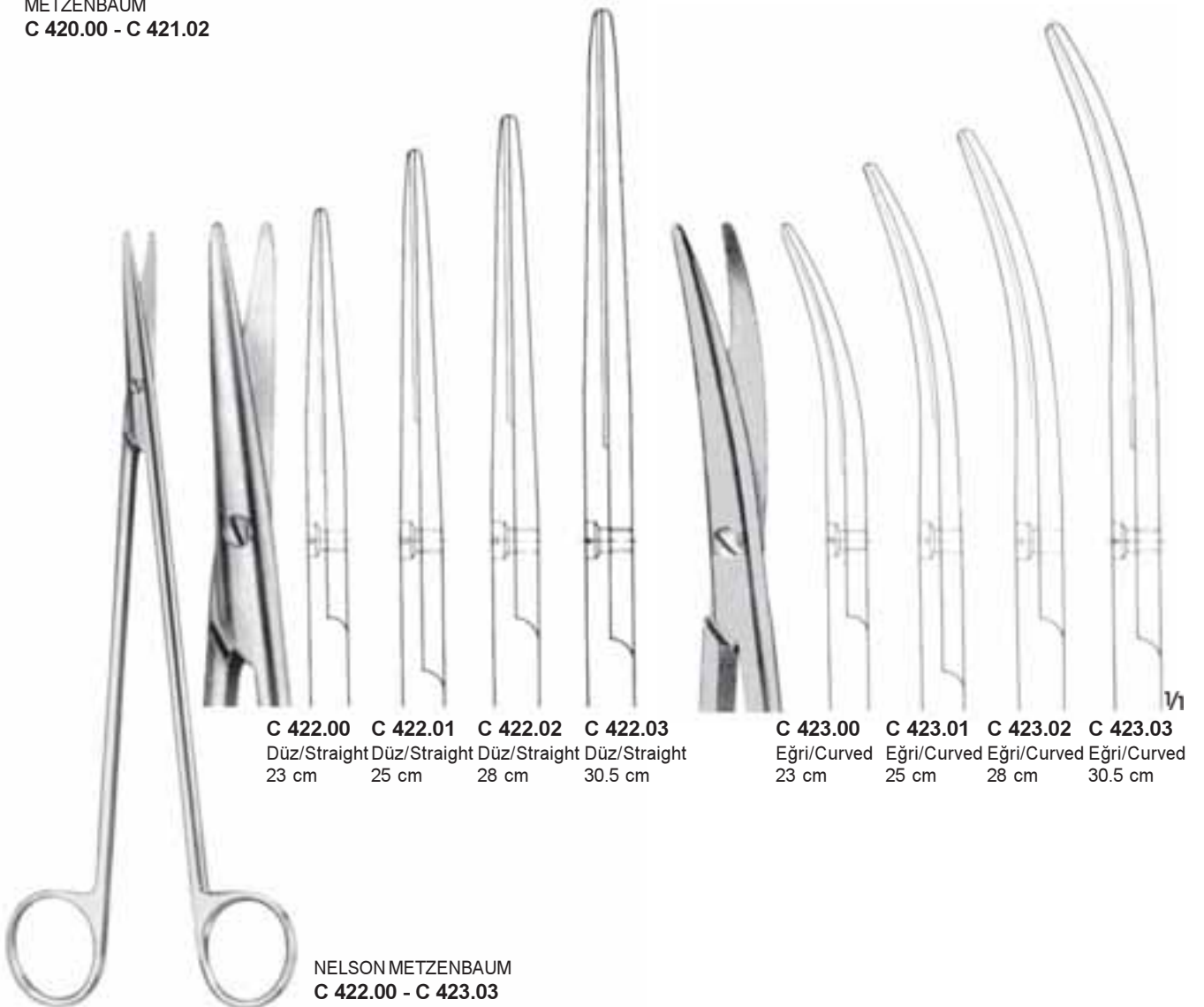

C 422.00 Düz/Straight 23 cm
C 422.01 Düz/Straight 25 cm
C 422.02 Düz/Straight 28 cm
C 422.03 Düz/Straight 30.5 cm

C 423.00 Eğri/Curved 23 cm
C 423.01 Eğri/Curved 25 cm
C 423.02 Eğri/Curved 28 cm
C 423.03 Eğri/Curved 30.5 cm

NELSON METZENBAUM
C 422.00 - C 423.03

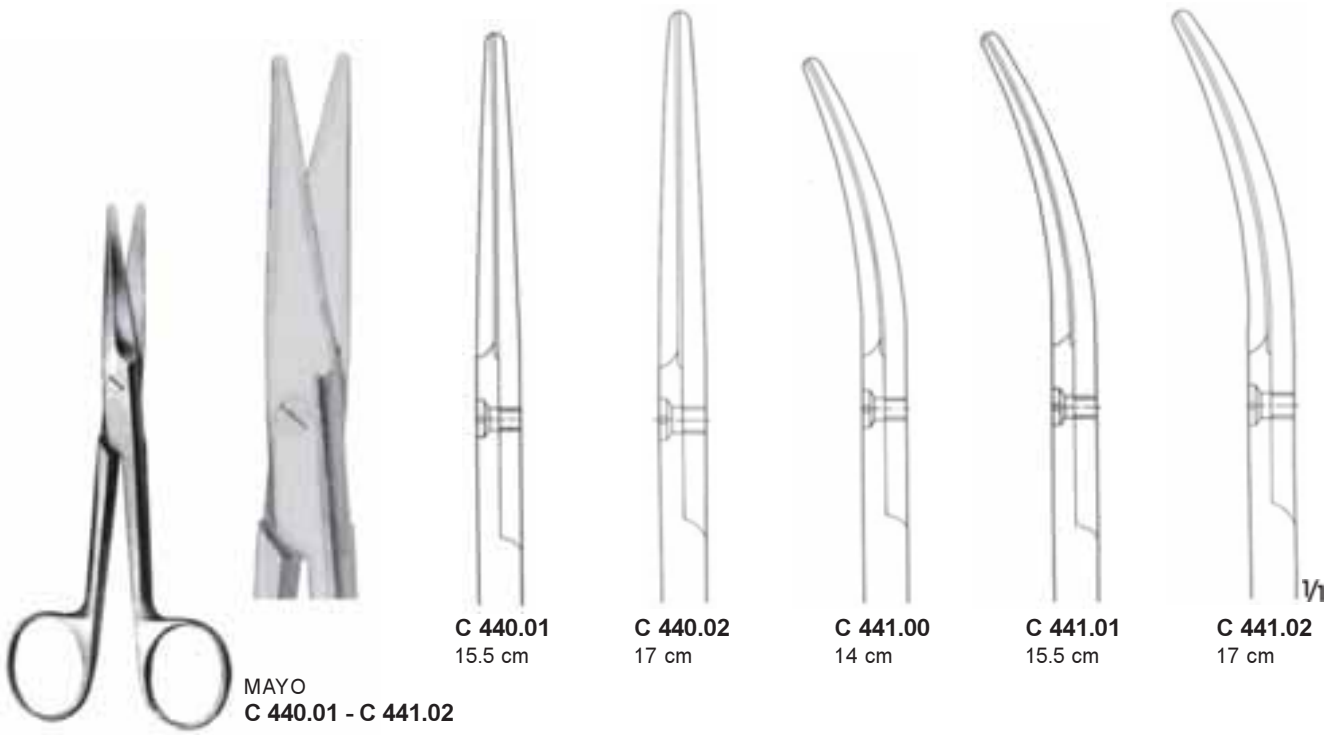

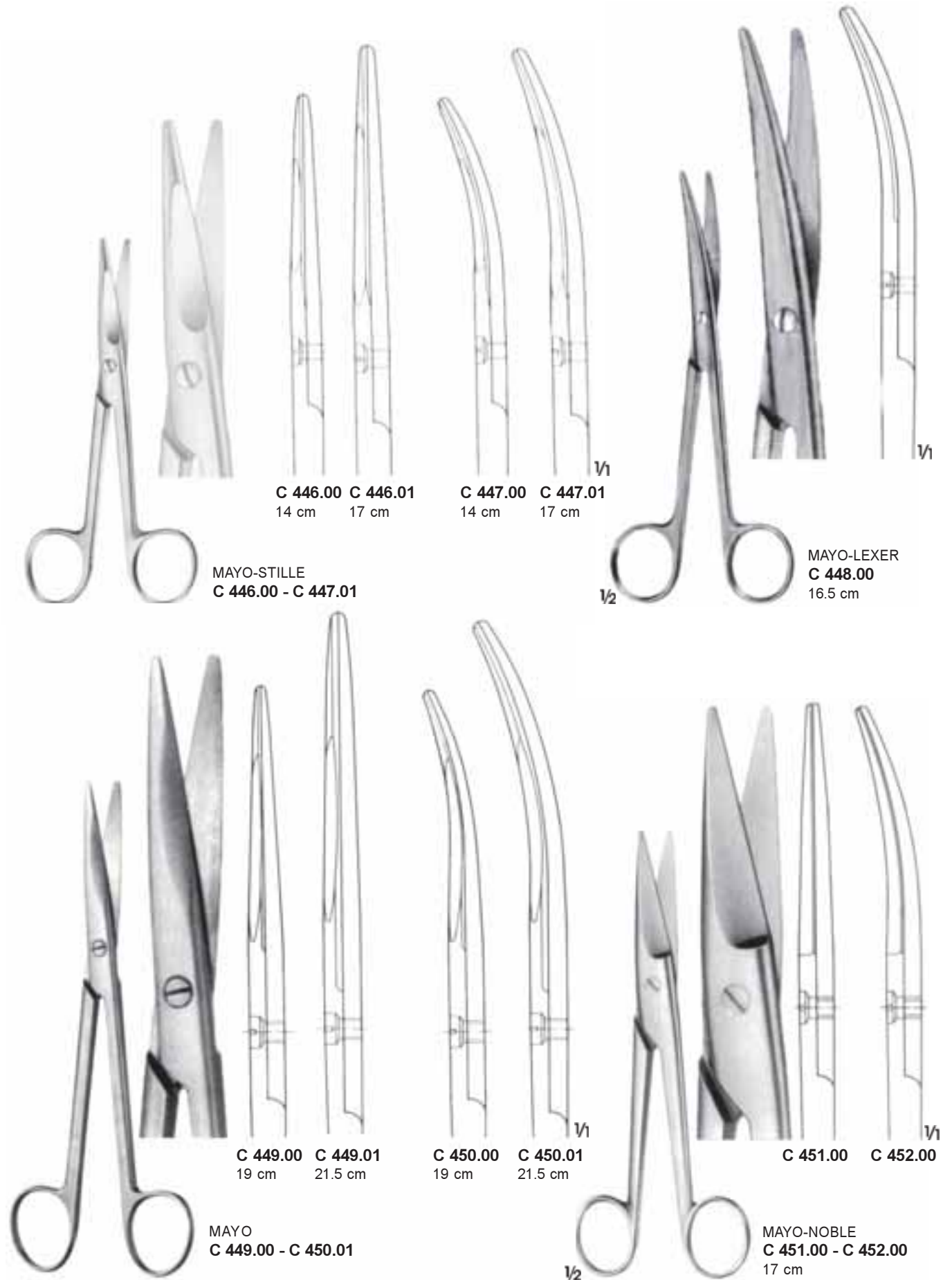

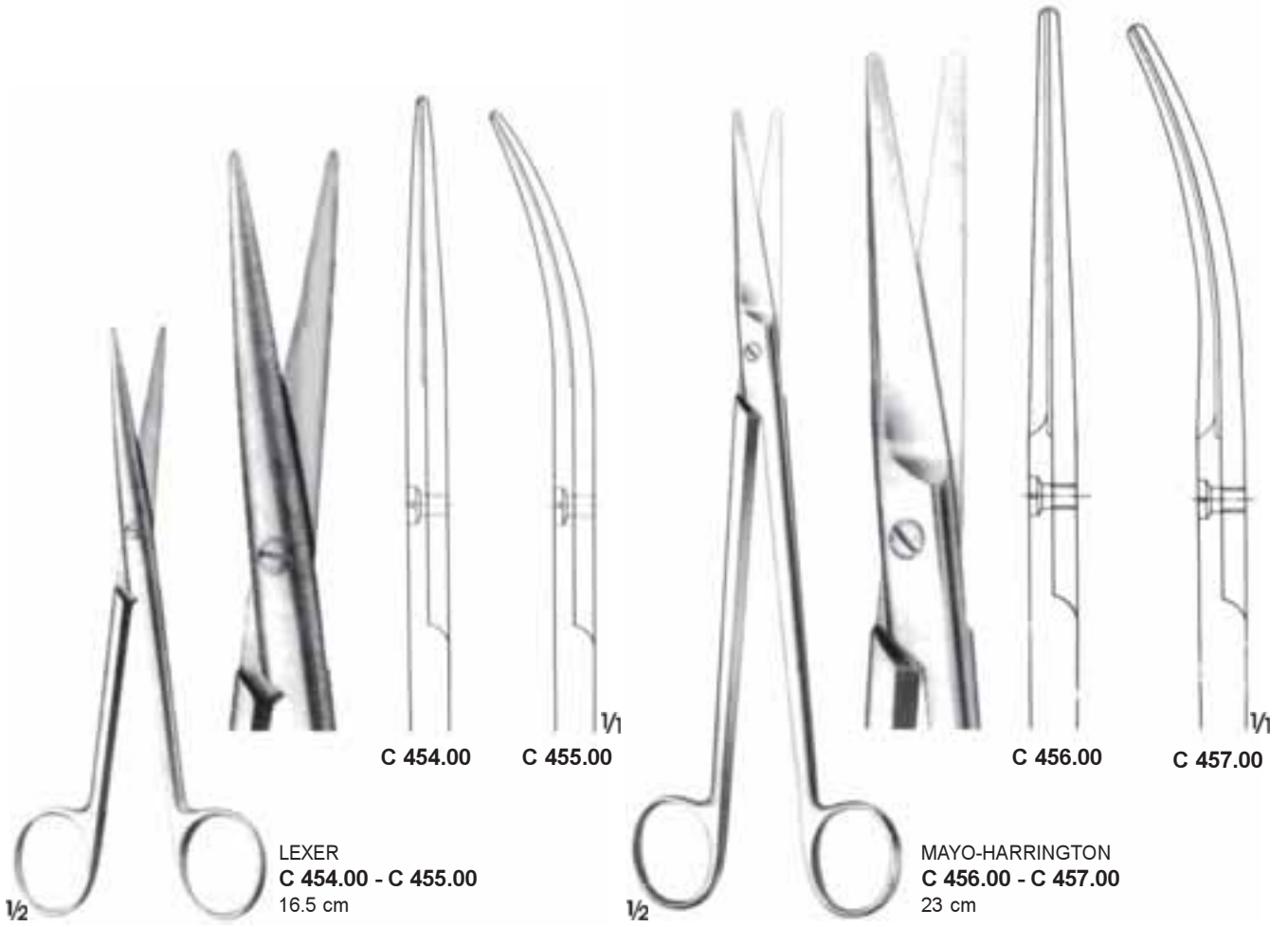

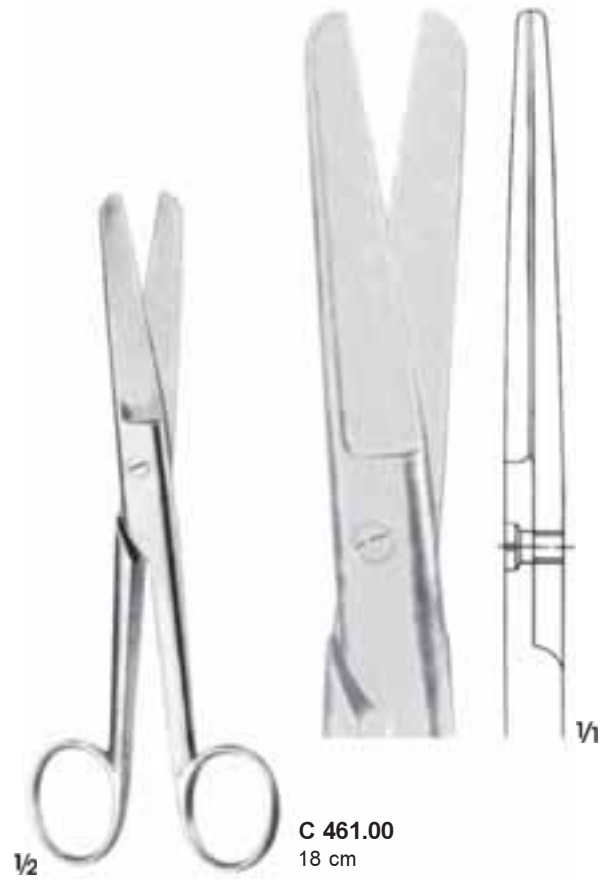

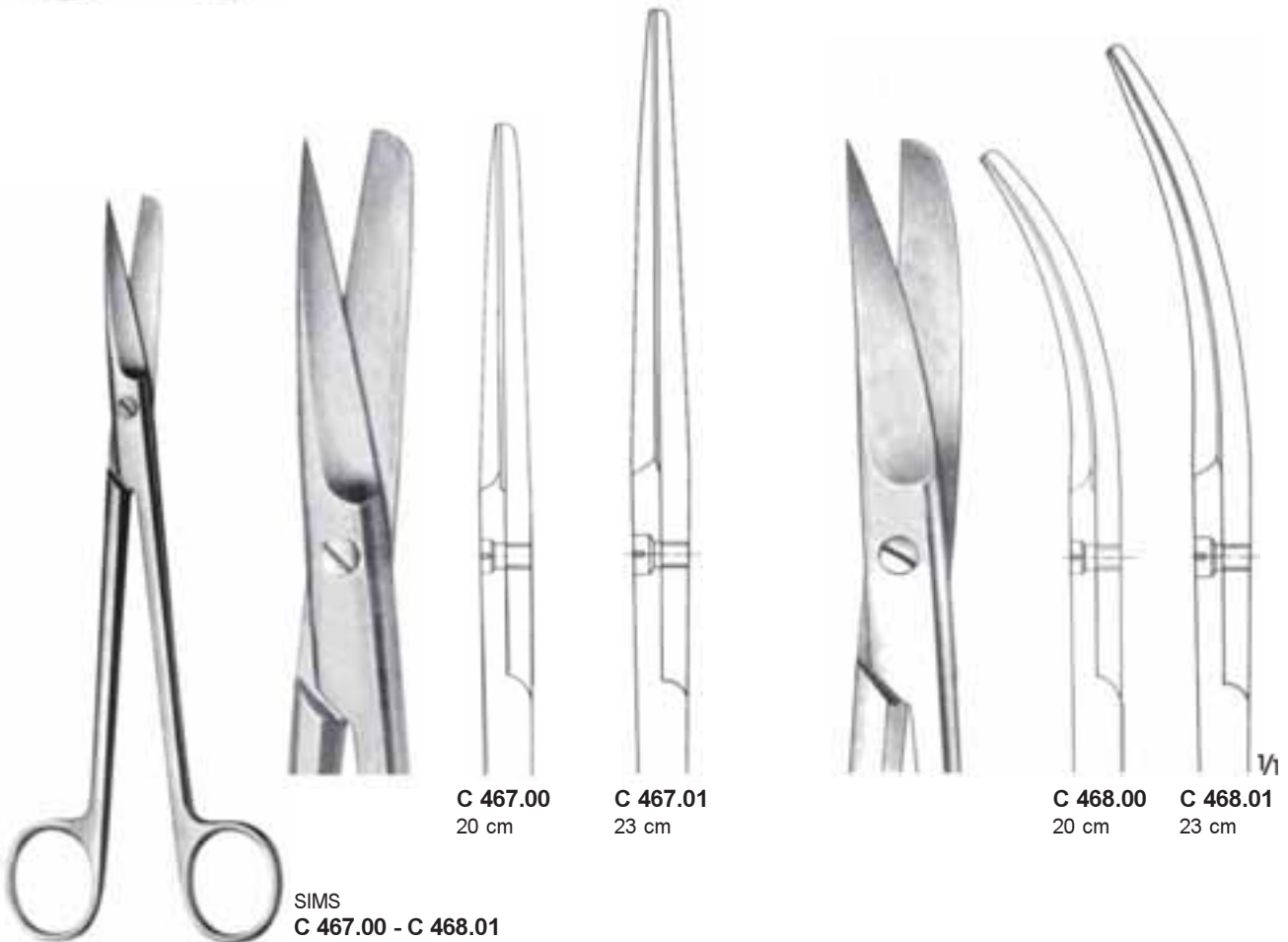
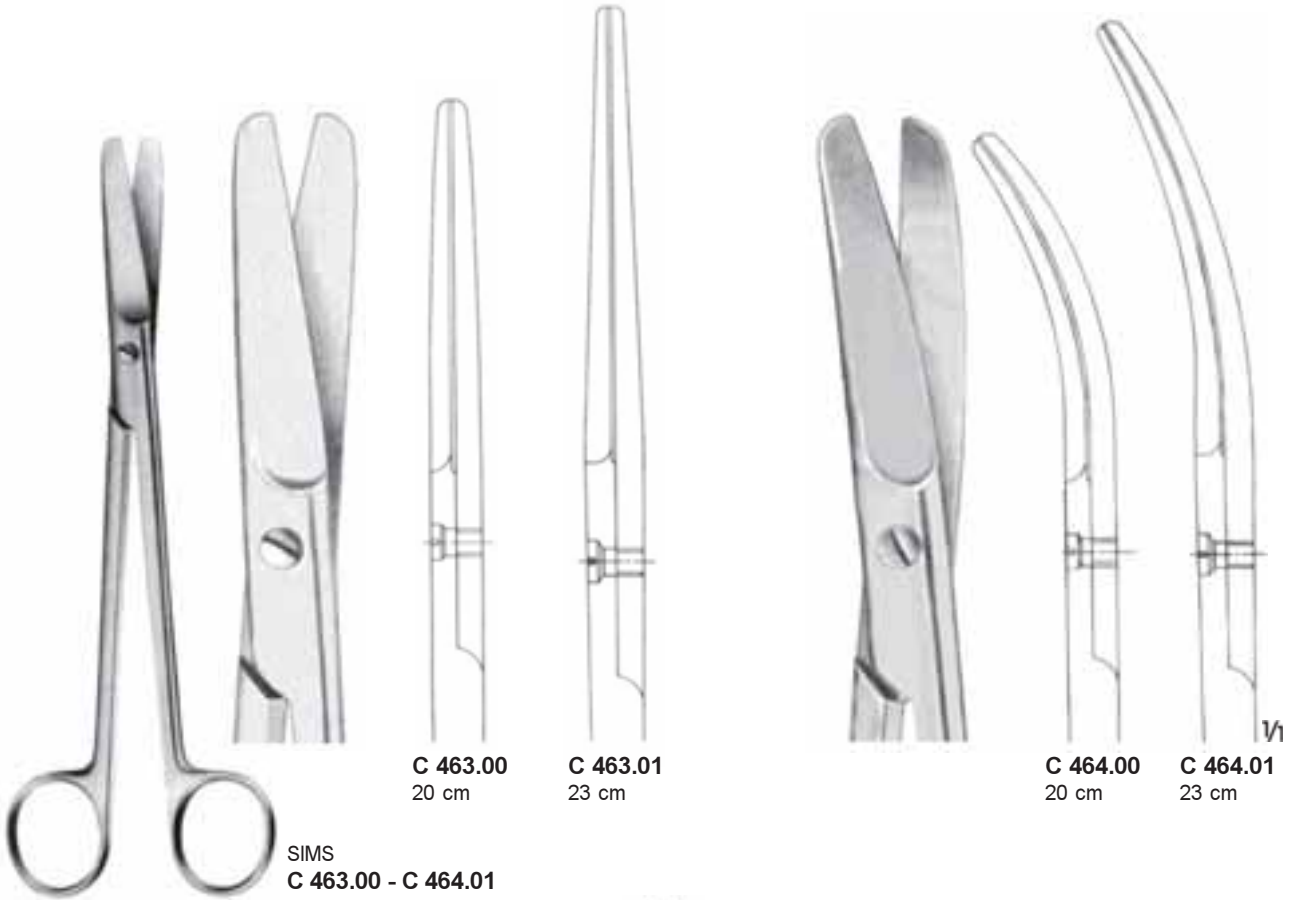



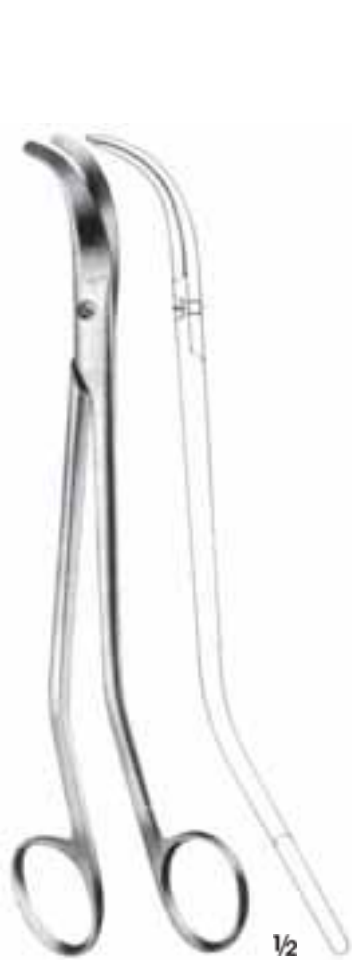
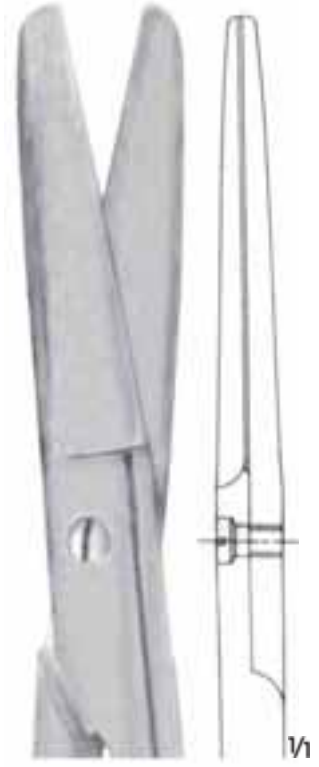

BOZEMANN
C 490.00
22 cm



SIEBOLD
C 491.00
24.5 cm



SIMS SIEBOLD
C 492.00
25 cm

Sert Metal Ağızlı / Hard Metal Edged



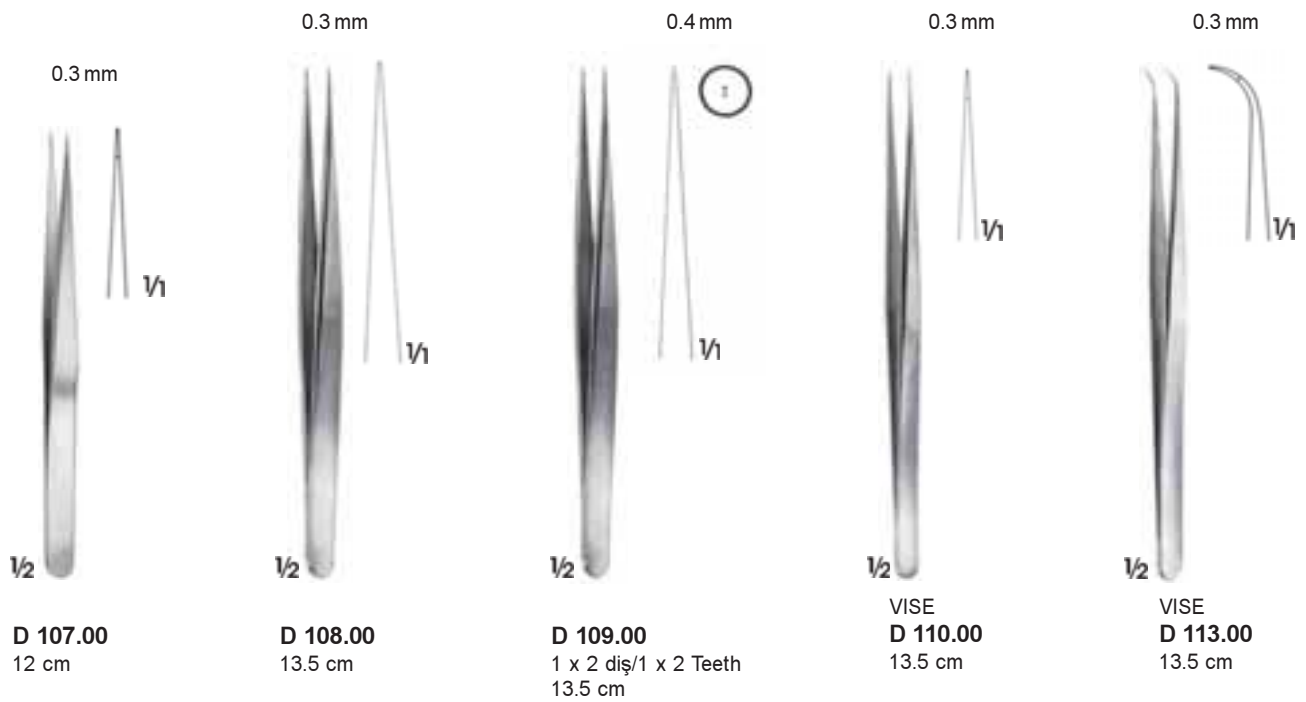
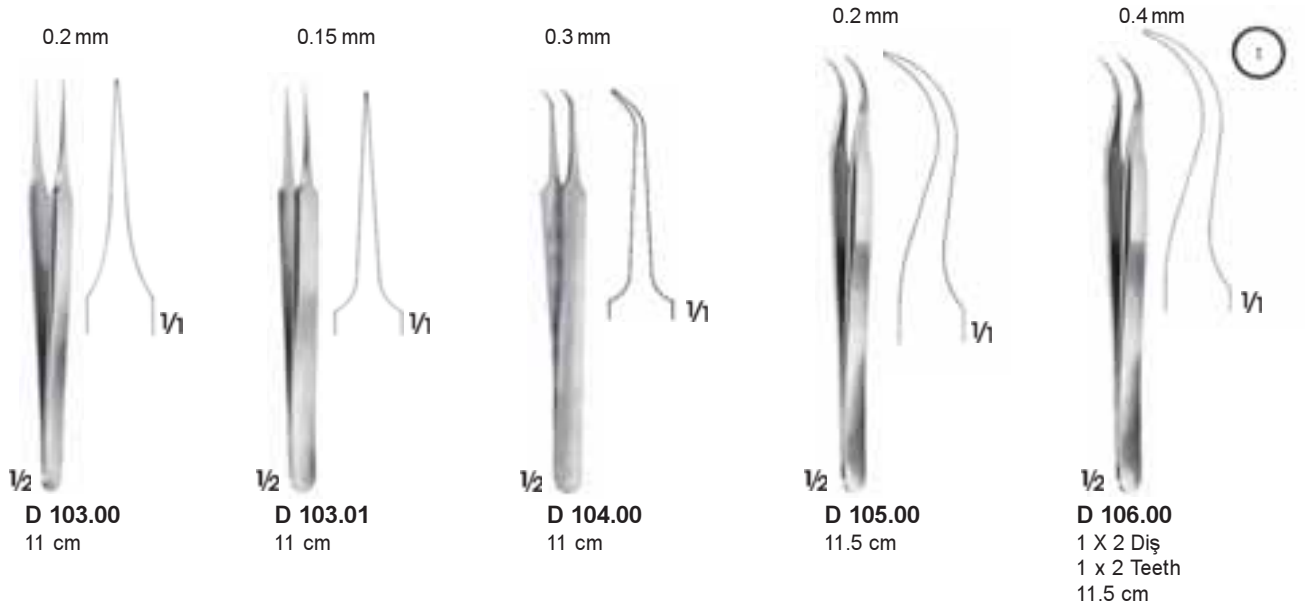

0.5 mm

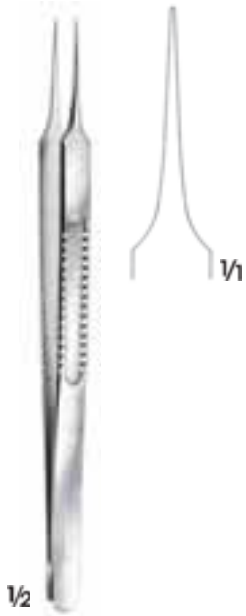

LAZAR
D 127.00
 15.5 cm

0.8 mm



LAZAR
D 128.00
 15.5 cm

0.8 mm



AUSTIN
D 125.00
 14 cm

0.5 mm

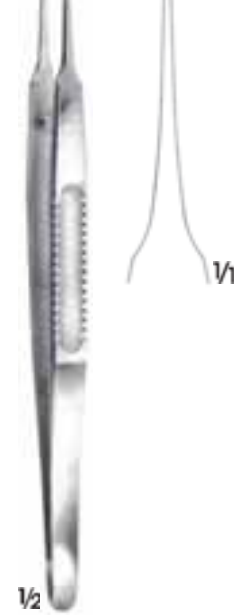

D 126.00
 18.5 cm

0.3 mm

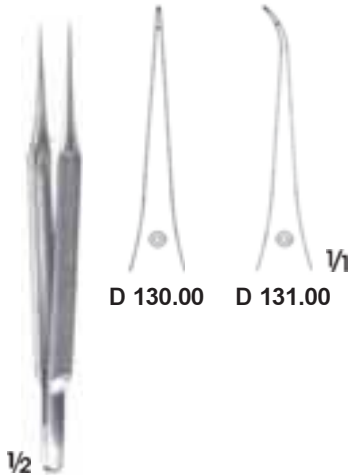

D 130.00 - D 131.00
 12 cm

0.3 mm



D 130.01 - D 131.01
 15 cm

0.6 mm

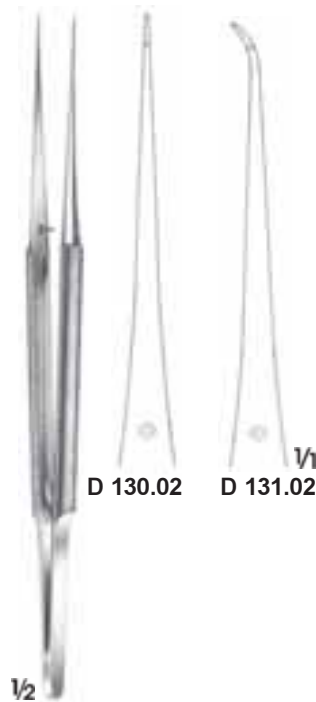

D 130.02 - D 131.02
 18 cm

0.6 mm



D 133.00
 23 cm



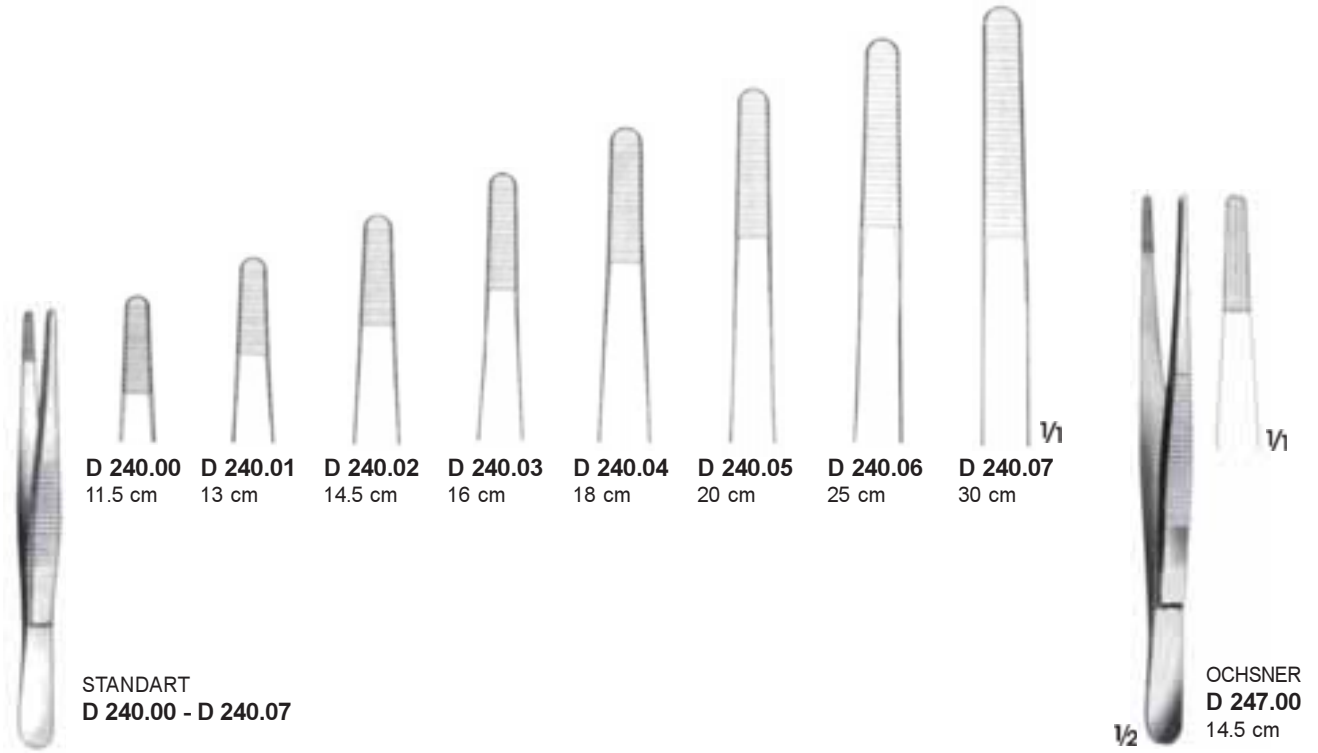

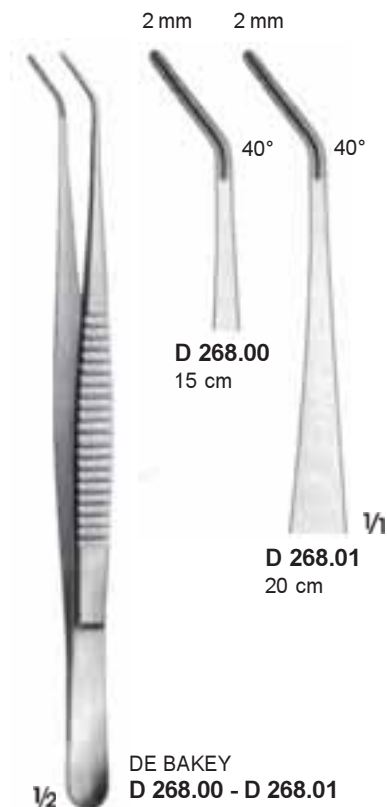
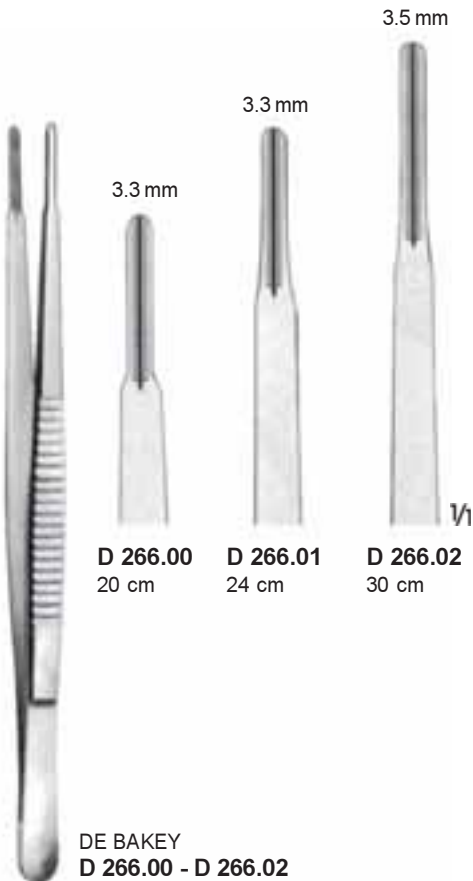
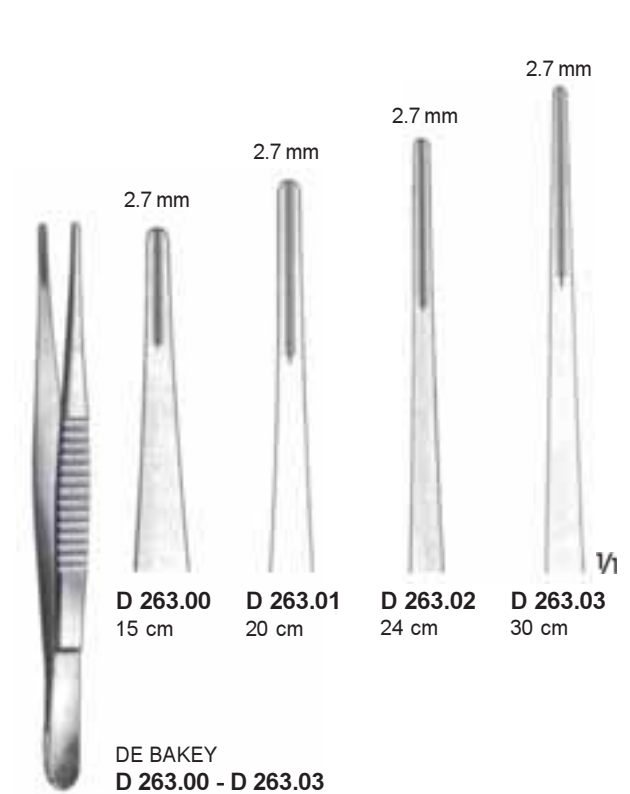
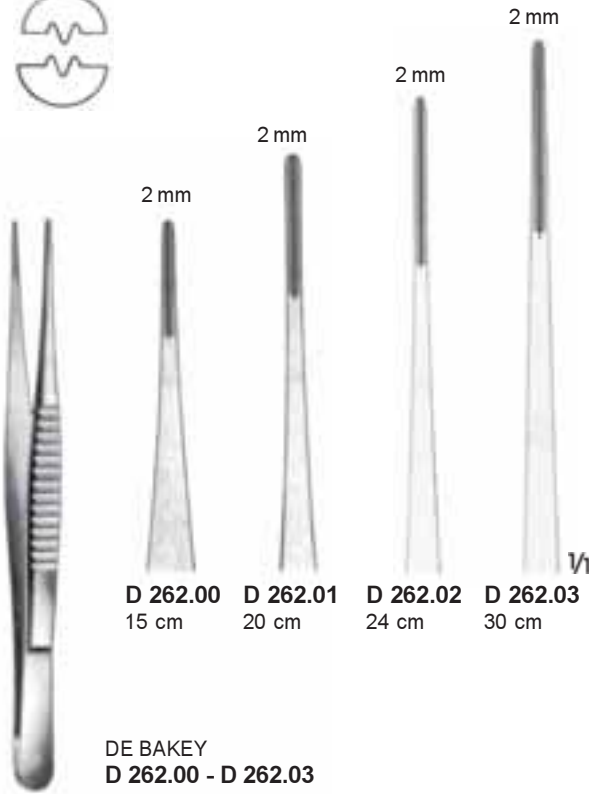



$\frac{1}{2}$
MICRO-ADSON
D 322.00
12 cm

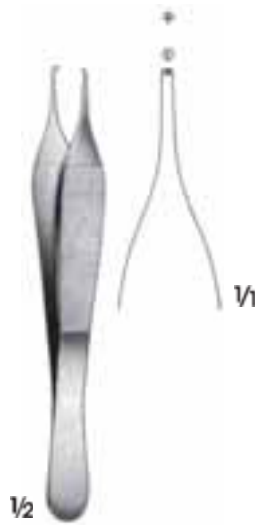

$\frac{1}{2}$
ADSON
D 323.00
12 cm

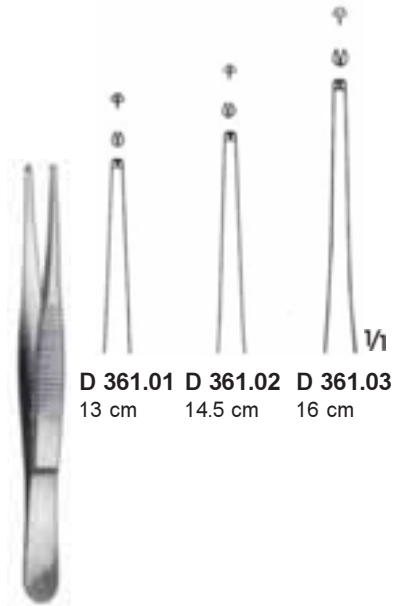

D 361.01 - D 361.03
13 cm 14.5 cm 16 cm



$\frac{1}{2}$
ADSON-BROWN
D 340.00
12 cm

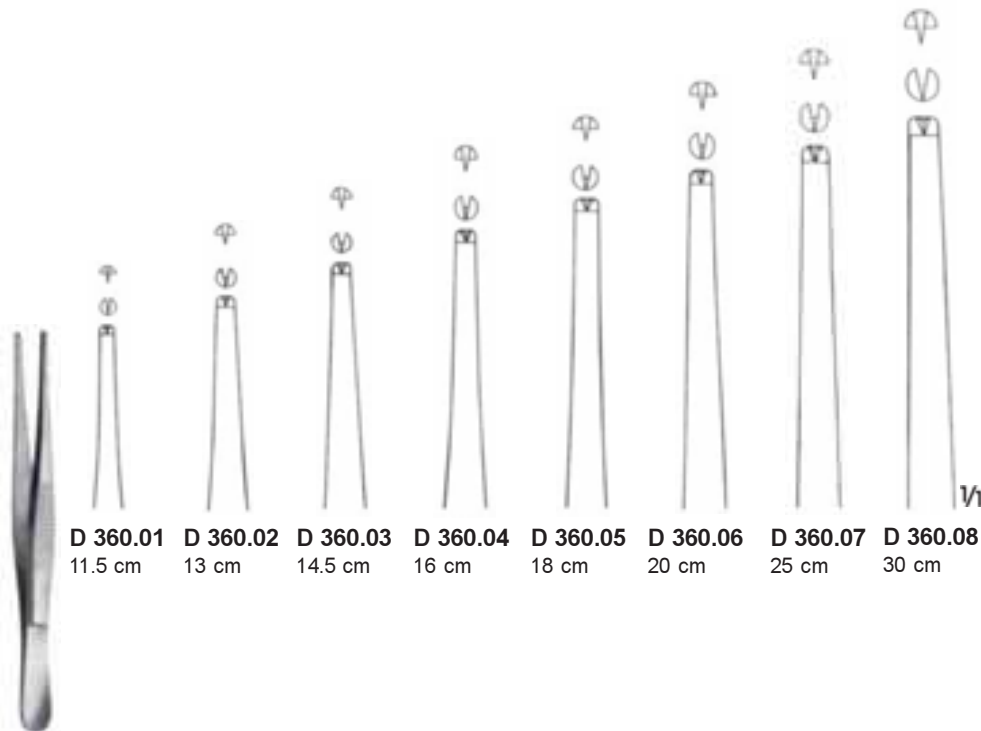

STANDARD
D 360.01 - D 360.08

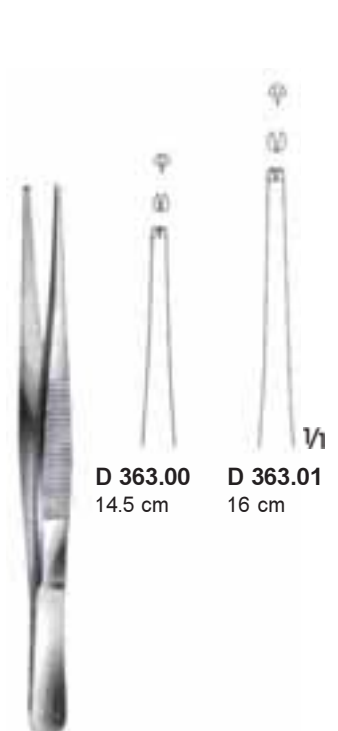

D 363.00-D 363.01

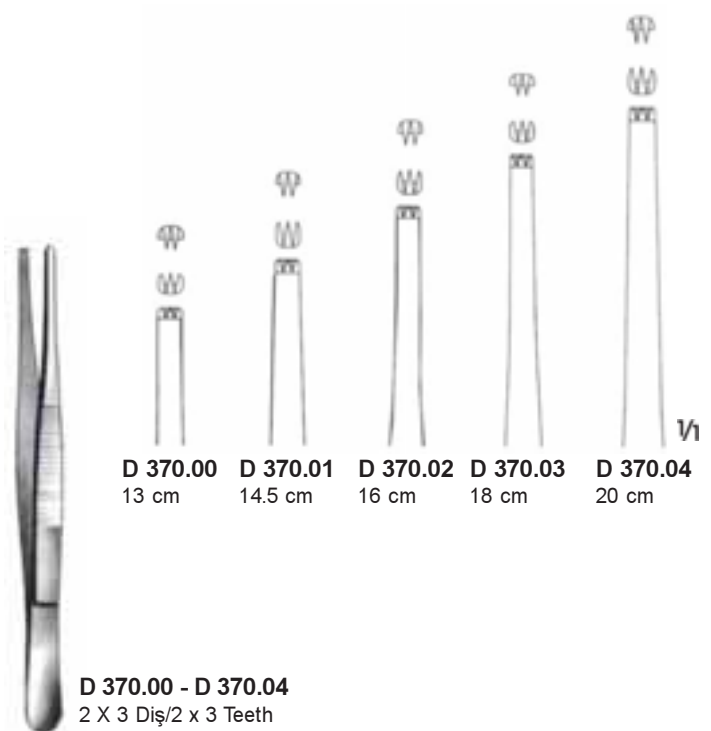
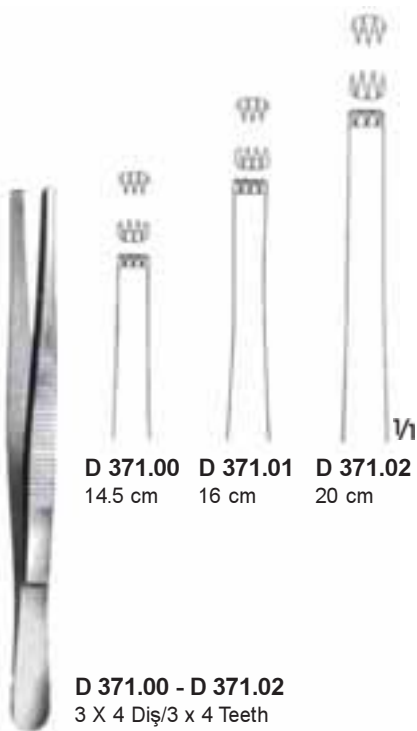
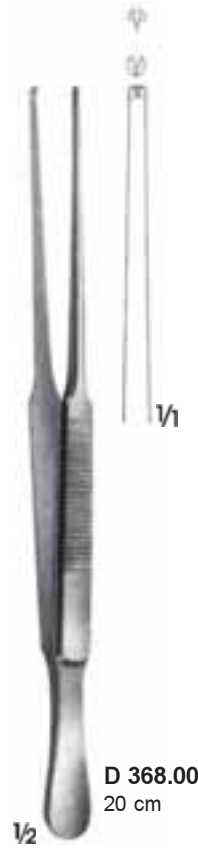
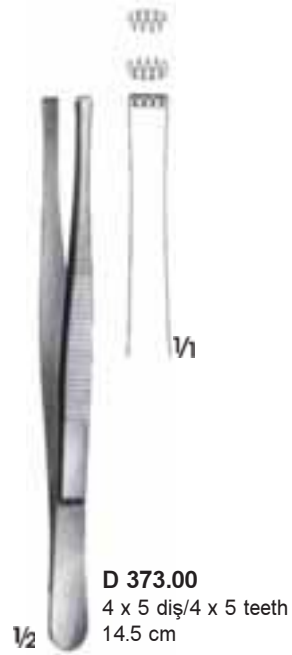
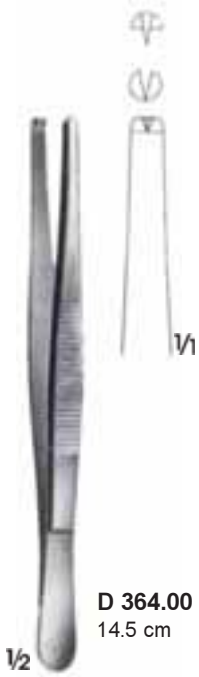

Sert Metal Ağızlı/Hard Metal Edged

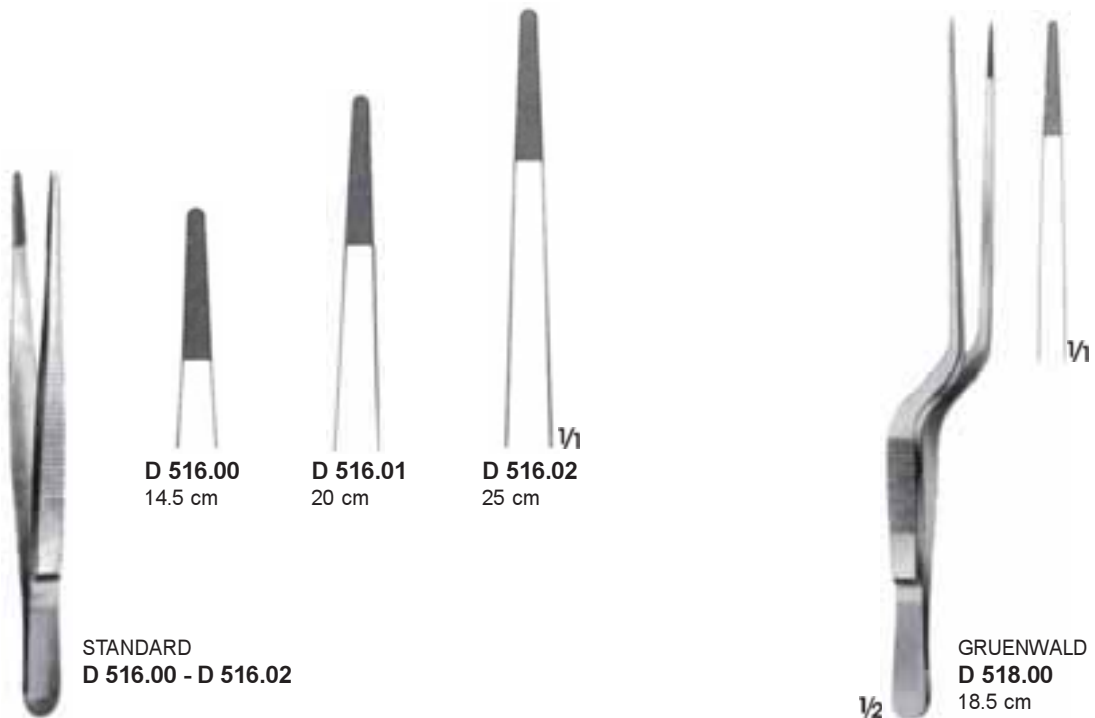
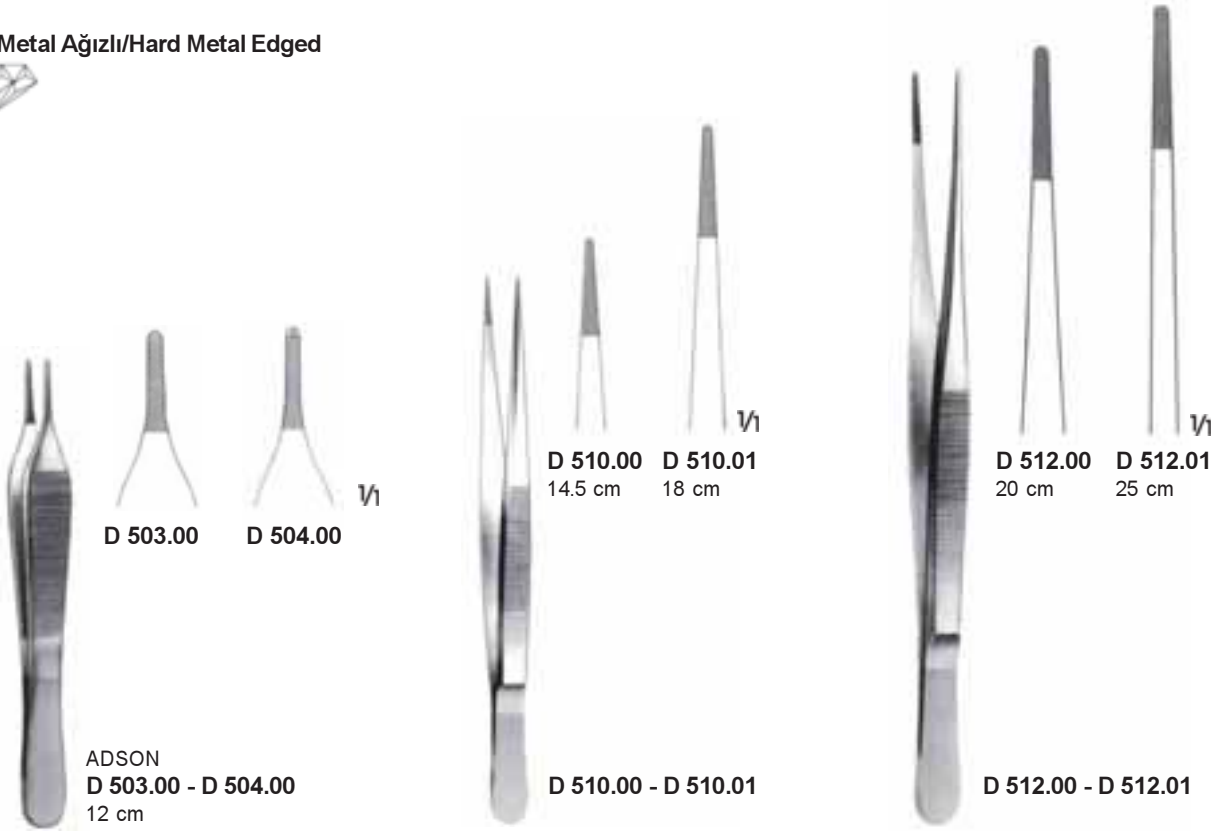

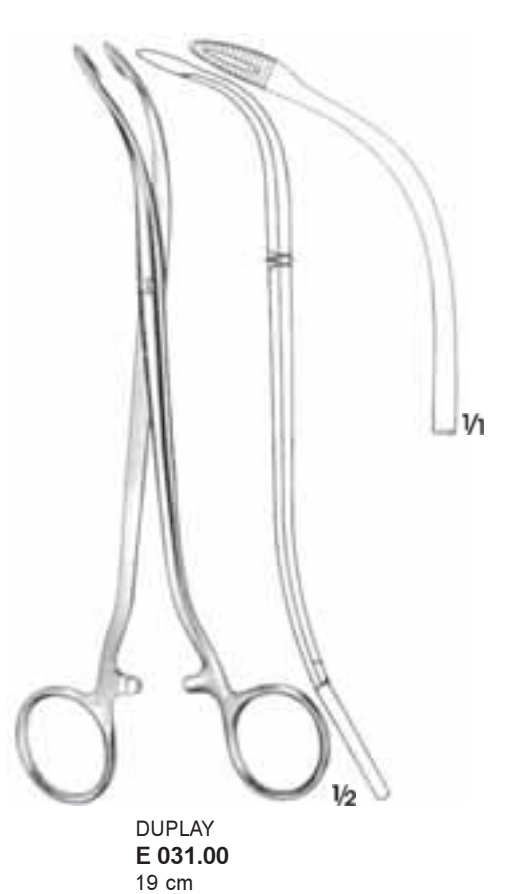
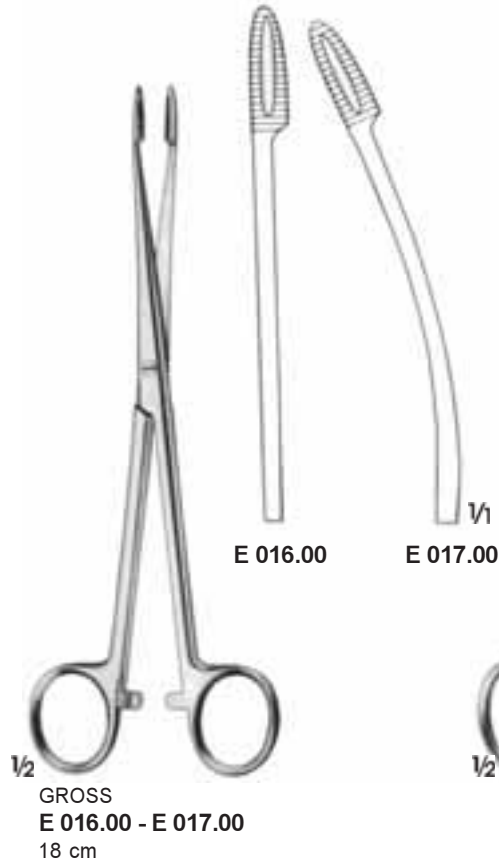
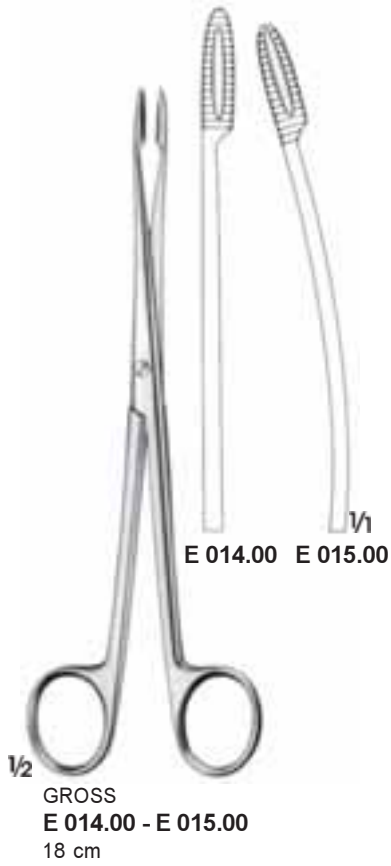

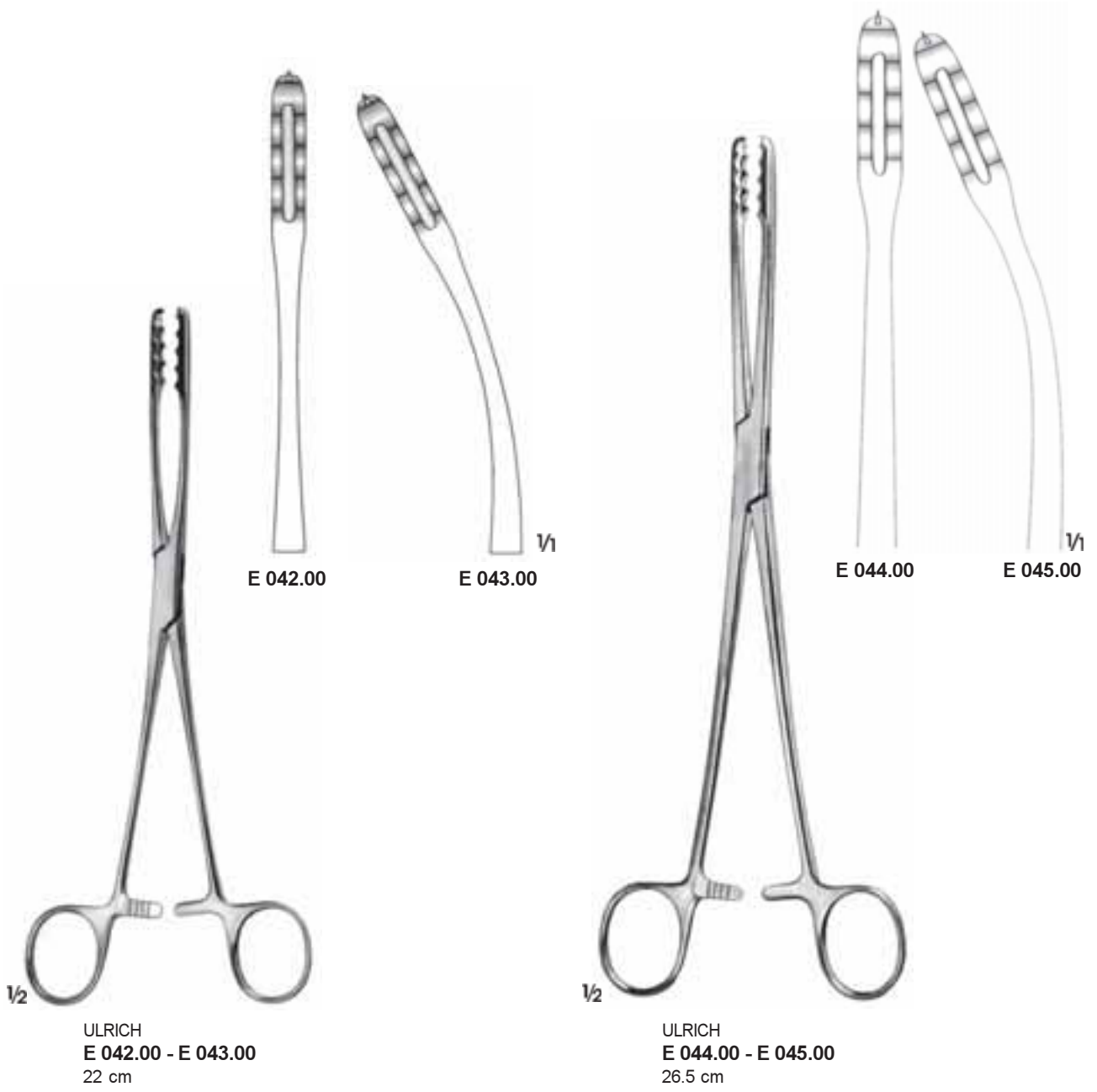

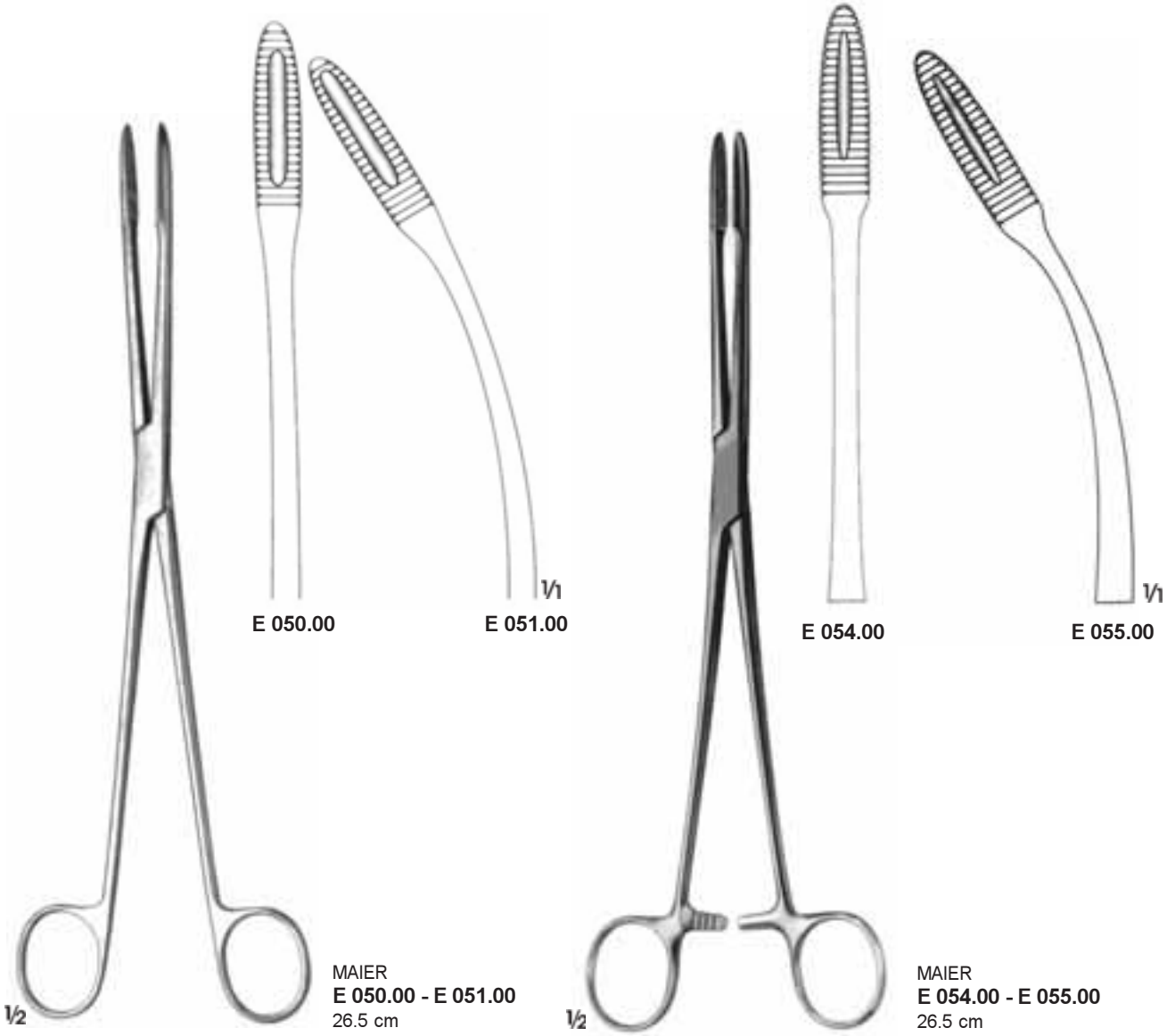



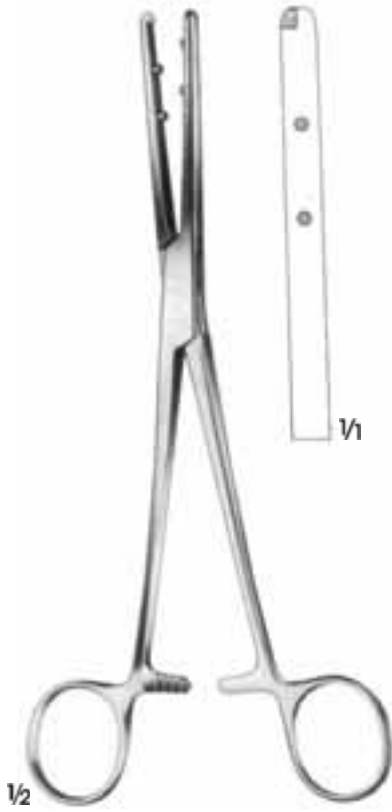

EMMET
E 070.00
21 cm



COLLIN
E 071.00
24 cm

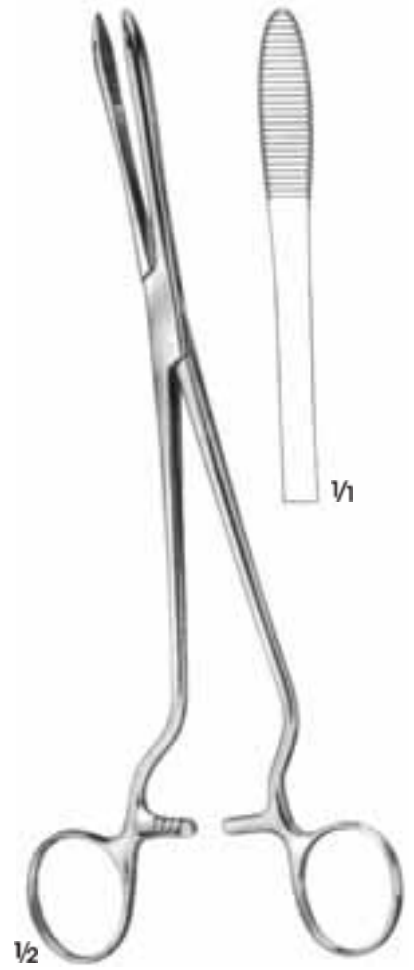

CHERON
E 072.00
24 cm

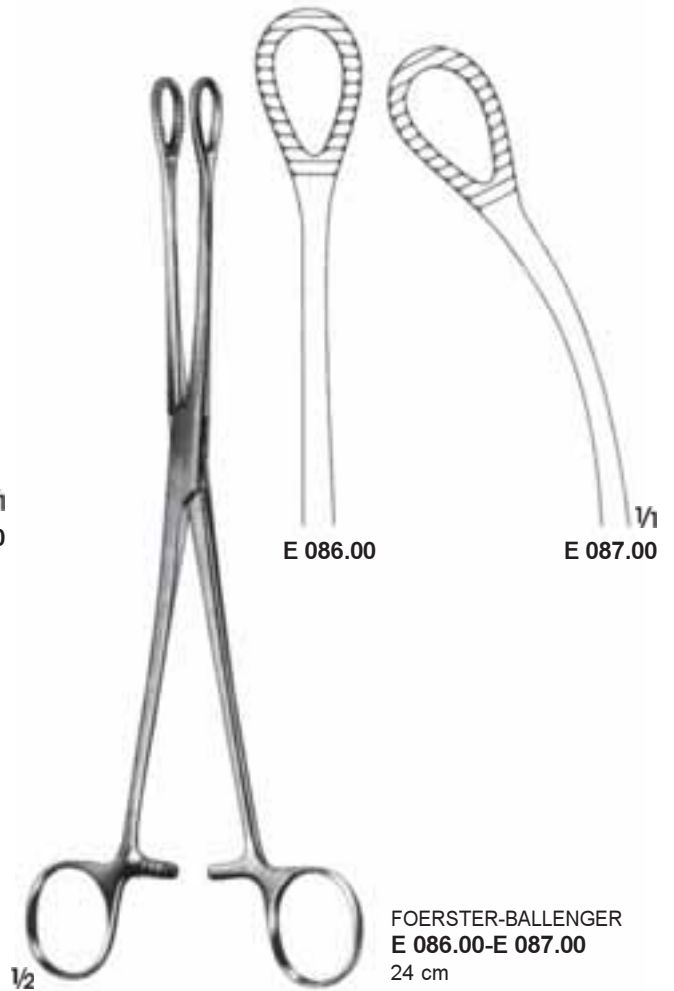
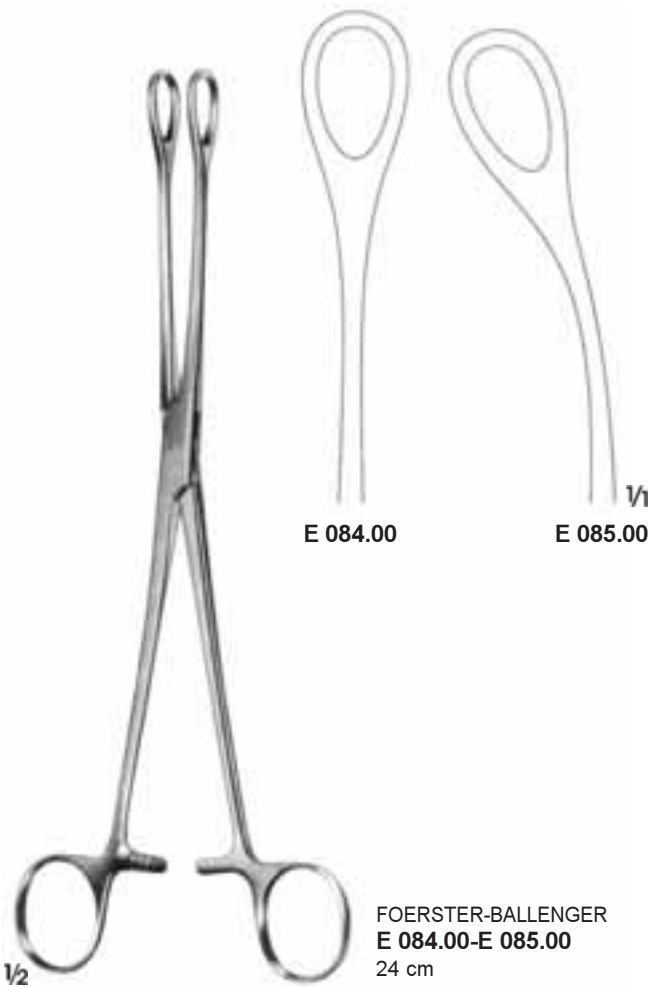
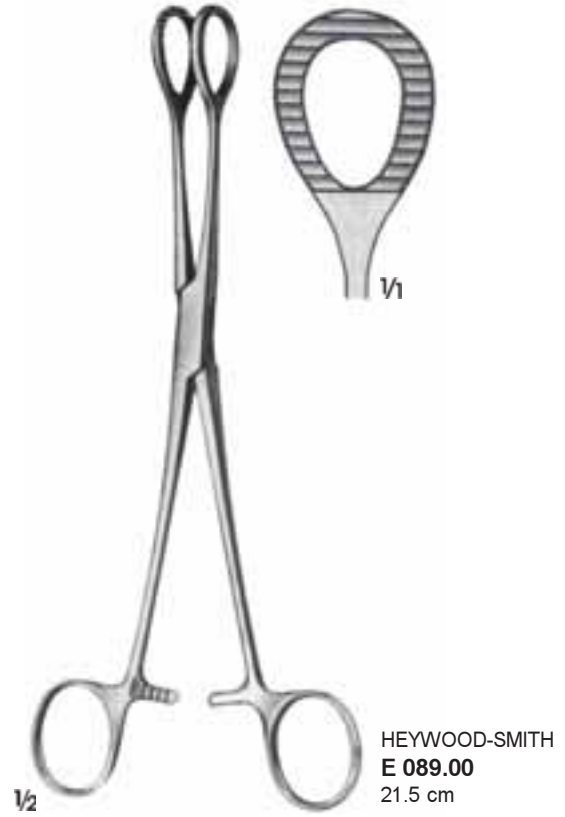
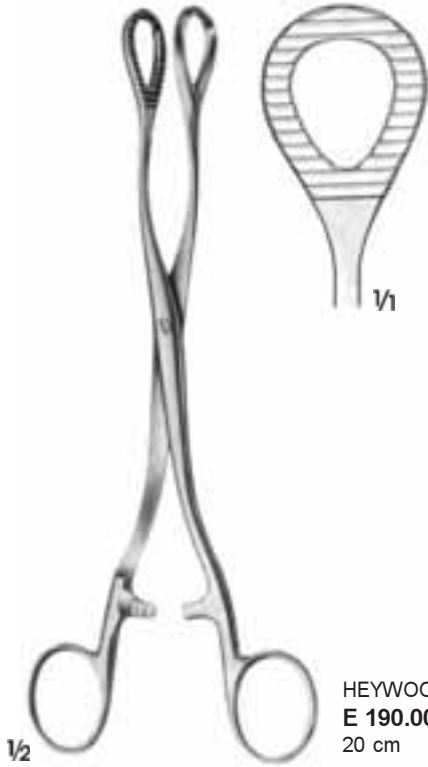



BOYS-ALLIS
E 143.00
5 X 6 Diş/5 X 6 Teeth
15.5 cm



ALLIS
E 144.00
5 X 6 Diş/5 X 6 Teeth
15.5 cm



ALLIS
E 145.00
4 X 5 Diş/4 X 5 Teeth
15.5 cm



ALLIS
E 150.00-E 150.08



ALLIS
E 147.01
5 x 6 Diş/5 x 6 Teeth
19 cm



ALLIS-THOMAS
E 158.00
6 X 7 diş/6 x 7 teeth
20 cm

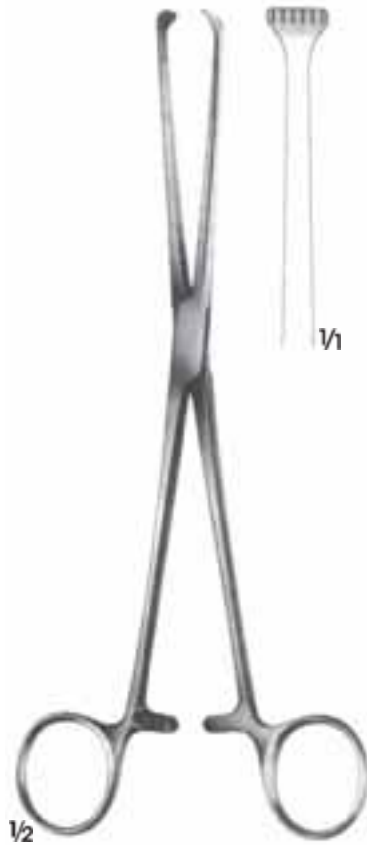

ALLIS
E 159.00
22 cm



ALLIS
E 147.03
5 x 6 Diş/Teeth
22.5 cm

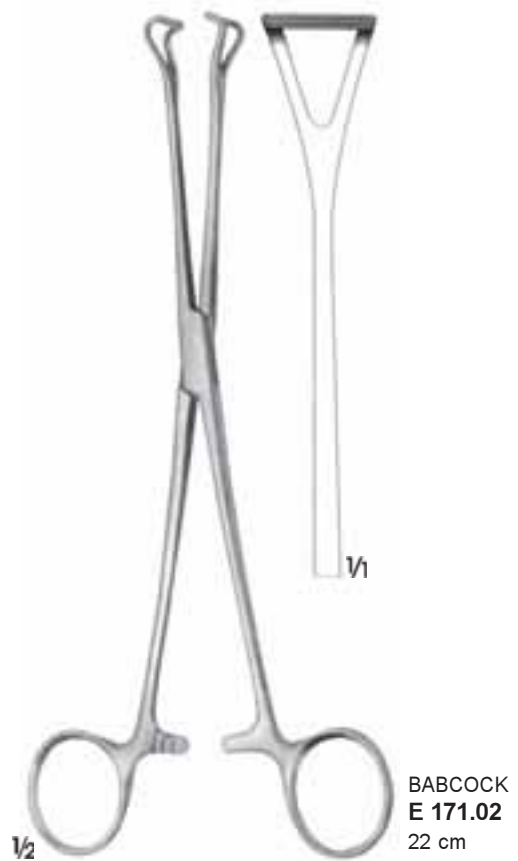
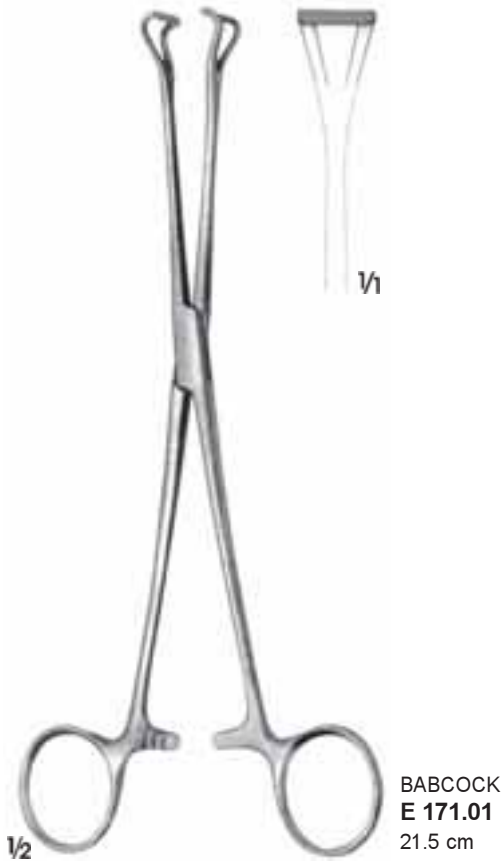
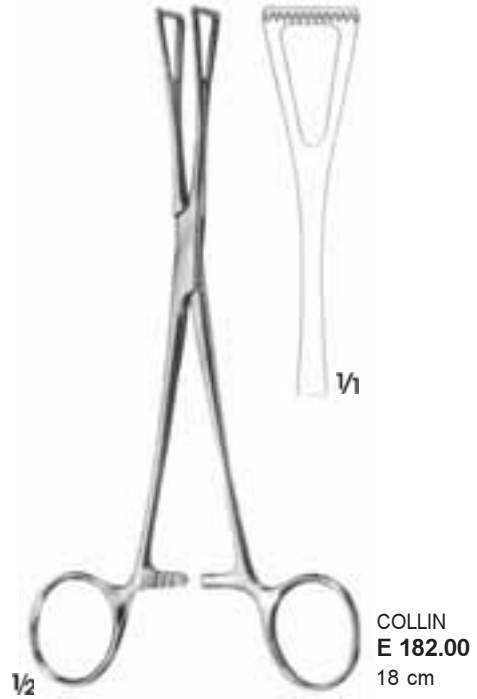

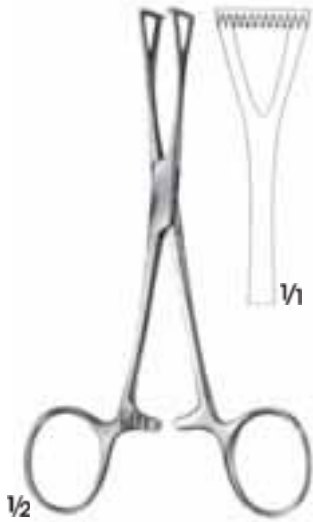

COLLIN
E 180.00
14 cm

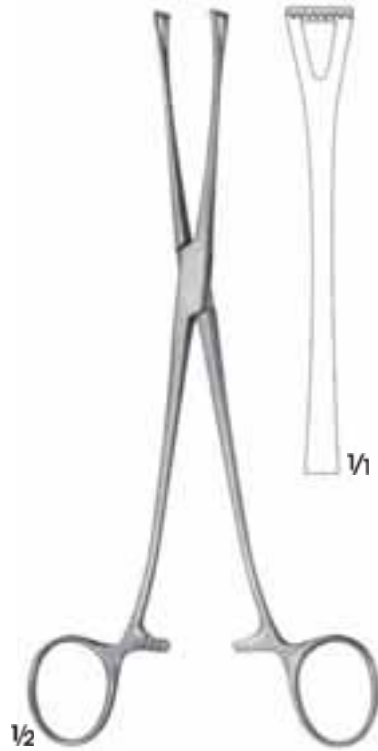

LOCKWOOD
E 186.00
20 cm



BABCOCK
E 170.00
15.5 cm



BABCOCK
E 171.00
17 cm

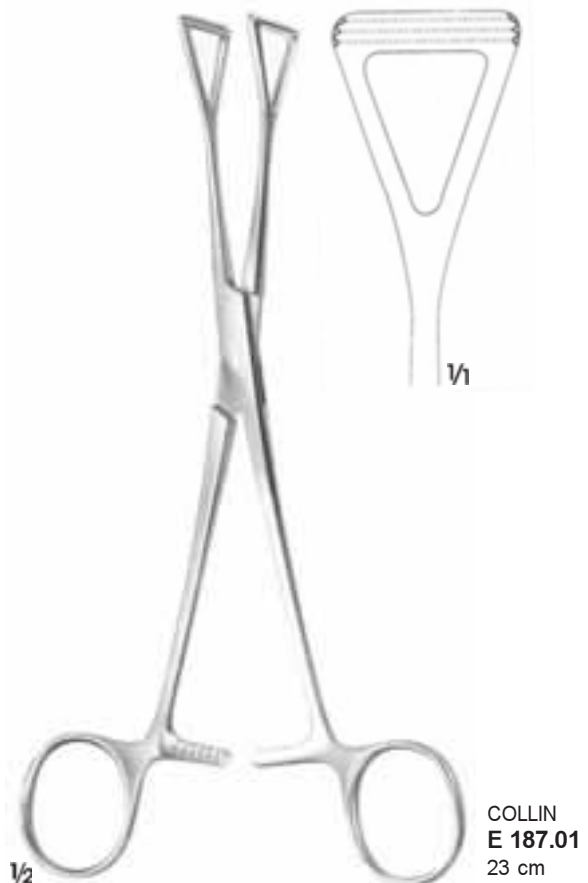
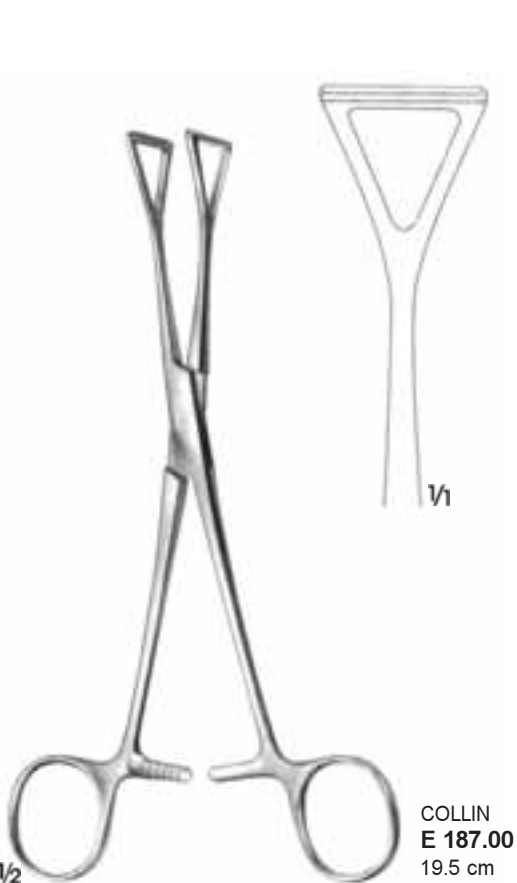
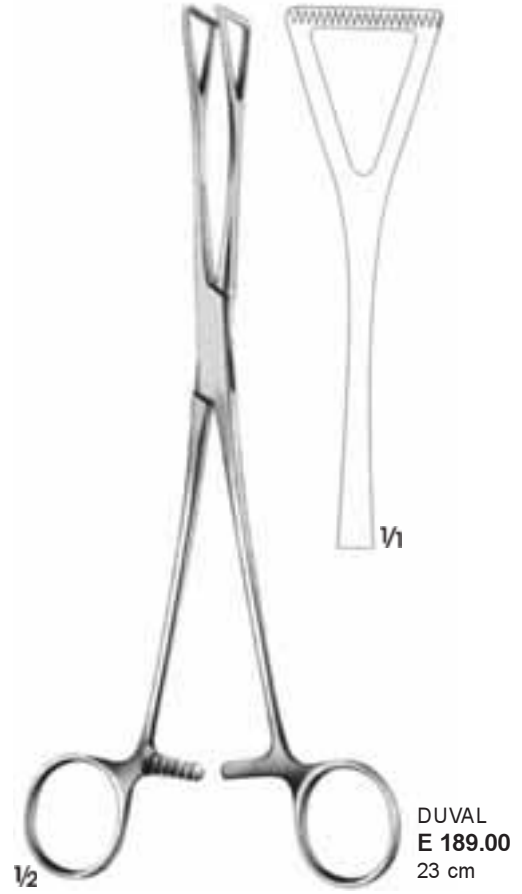

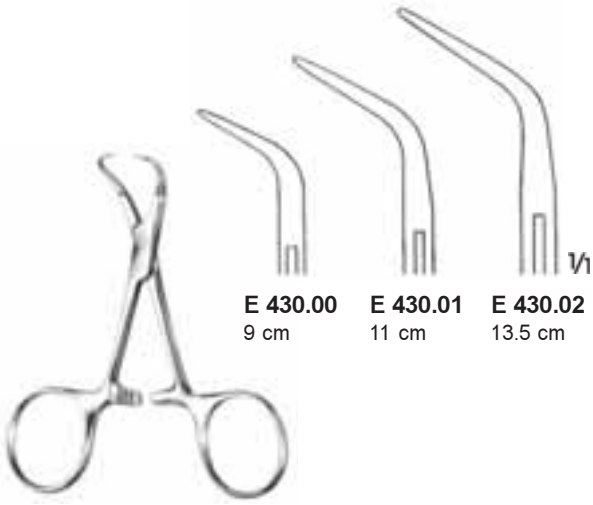

E 430.00 9 cm
E 430.01 11 cm
E 430.02 13.5 cm

BACKHAUS
E 430.00 - E 430.02



BACKHAUS-KOCHER
E 439.00
13.5 cm



MAYO
E 481.00
14 cm



ROEDER
E 442.00
13.5 cm



BUNT
E 480.00
10.5 cm

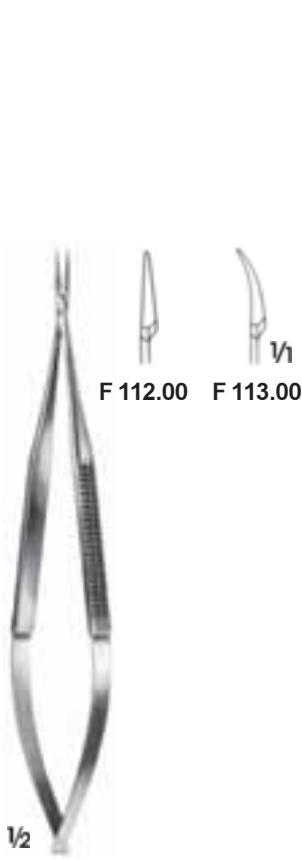

F 112.00 - F 113.00
Kilitsiz/Without catch
16 cm



F 114.00 - F 115.00
Kilitsiz/Without catch
18.5 cm



JACOBSON
F 116.00 - F 117.00
18.5 cm



F 138.00
Kilitli/With catch
23 cm



F 124.00 - F 125.00
Kilitli/With catch
15 cm



REILL
F 126.00 - F 127.00
Kilitsiz/Without catch
15 cm



F 132.00 - F 133.00
Kilitsiz/Without catch
18.5 cm



F 134.00 - F 135.00
Kilitli/With catch
18.5 cm



DERF
F 206.00
12.5 cm



BAUMGARTNER
F 210.00
14.5 cm



CRILE-WOOD
F 215.00
15 cm



KILNER
F 221.00
13.5 cm

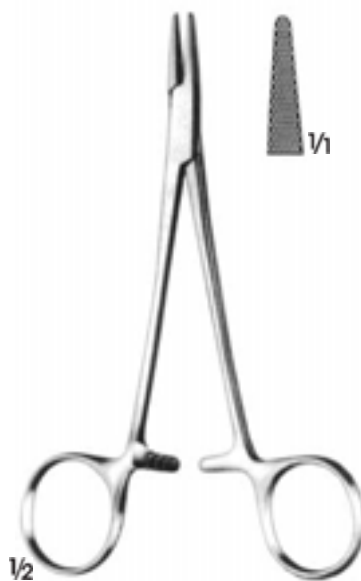

CRILE-MURKAY
F 219.00
15 cm



CRILE-WOOD
F 217.00
16 cm

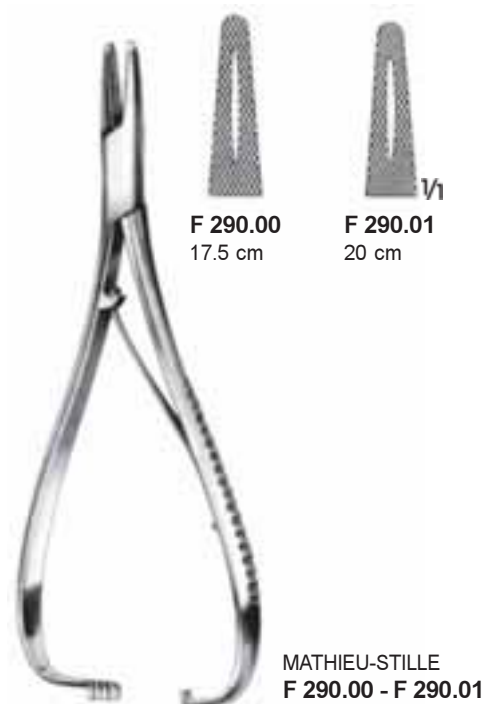

Sert Metal Ağızlı/Hard Metal Edged

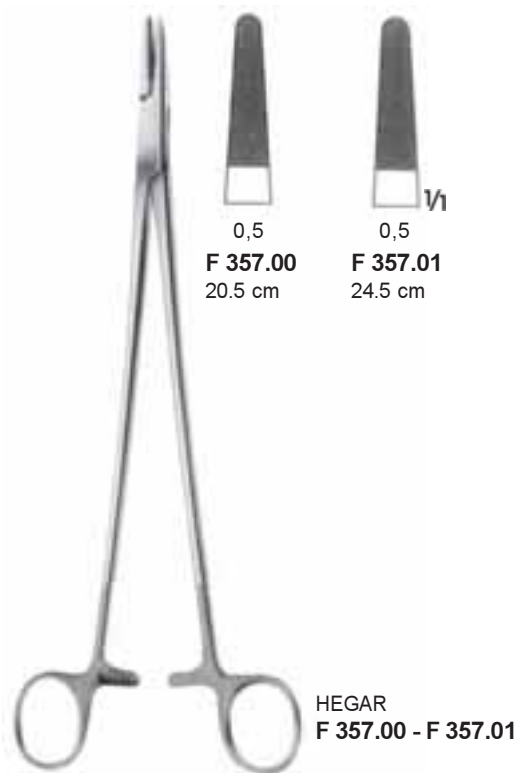
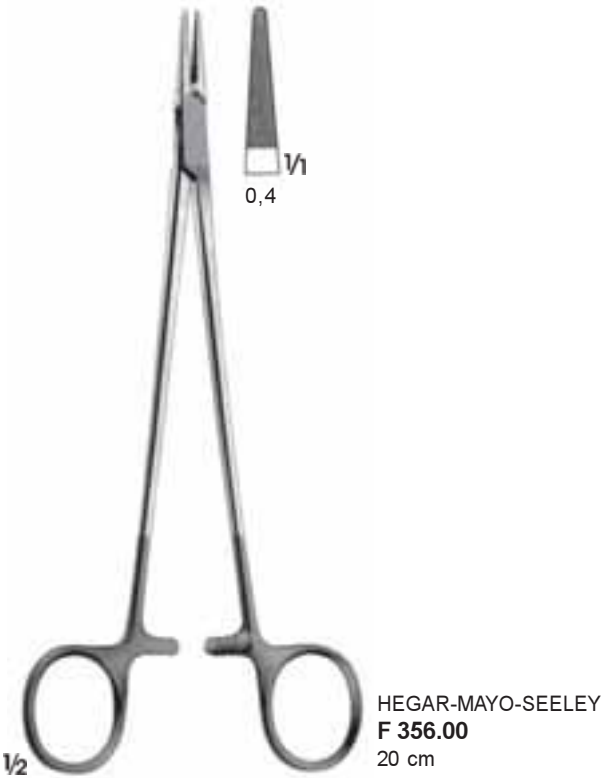
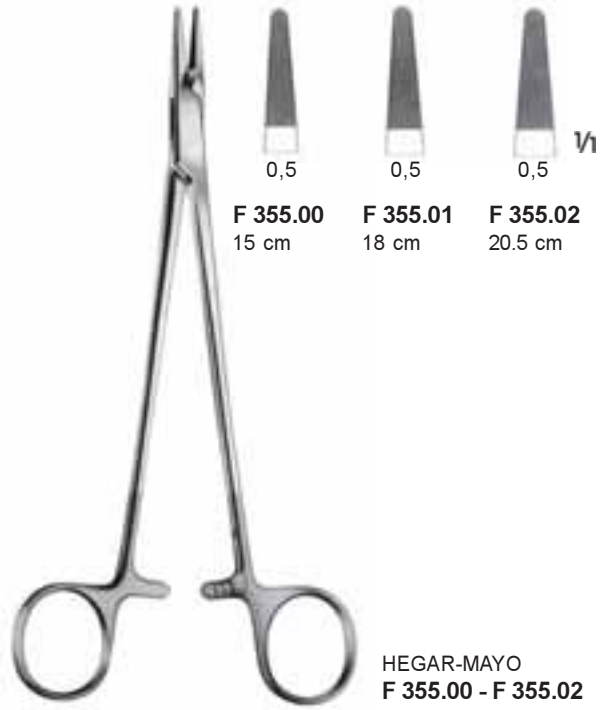

Sert Metal Ağzılı/Hard Metal Edged



WANGENSTEEN
F 360.02
27.5 cm



MASSON
F 361.02
26.5 cm



FINOCHIETTO
F 363.02
26.5 cm

Sert Metal Ağızlı/Hard Metal Edged

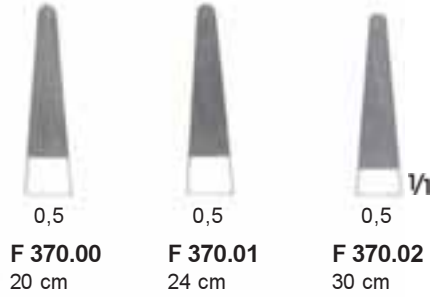
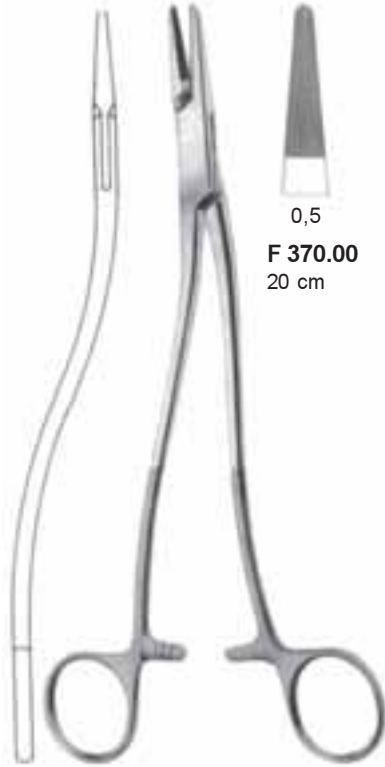

WERTHEIM
F 370.00 - F 370.02

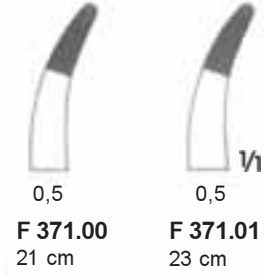
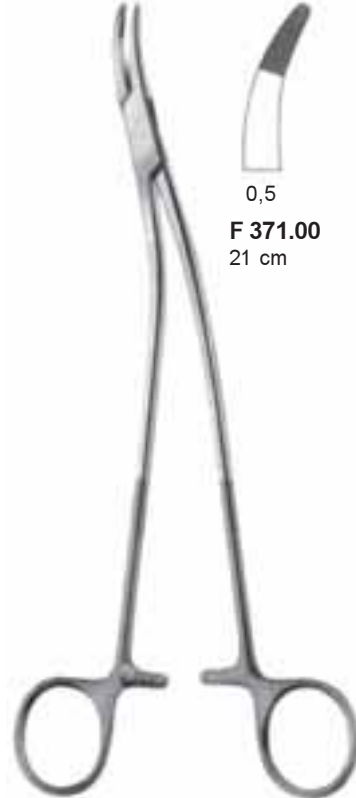

STRATTE
F 371.00 - F 371.01



HEANEY
F 373.00
20 cm



F 374.00
21.5 cm

Sert Metal Ağızlı/Hard Metal Edged

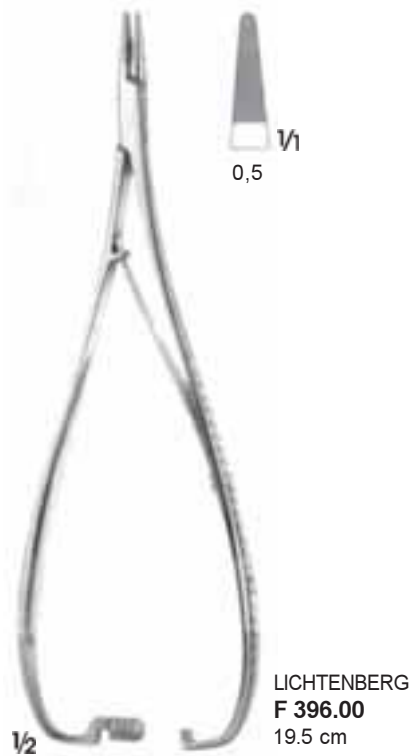
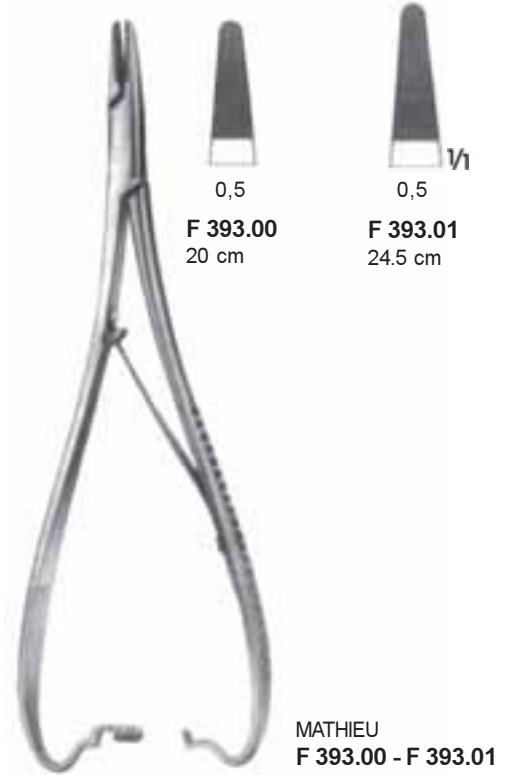
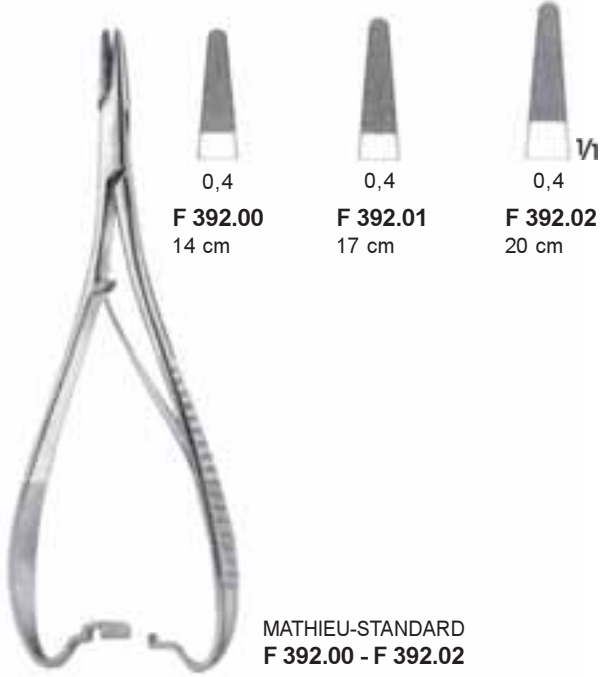

Sert Metal Ağızlı/Hard Metal Edged



F 372.00
27.5 cm



NAUNTON MORGAN
F 353.00
26 cm



HOSEL
F 397.00
26 cm



F 424.00

1/2



F 425.00

1/2

HURD
F 424.00 Sağ/Right
F 425.00 Sol/Left
Sivri/Sharp
21 cm



F 434.00

1/2



F 435.00

1/2

DESCHAMPS
F 434.00 Sağ/Right
F 435.00 Sol/Left
Künt/Blunt
21 cm

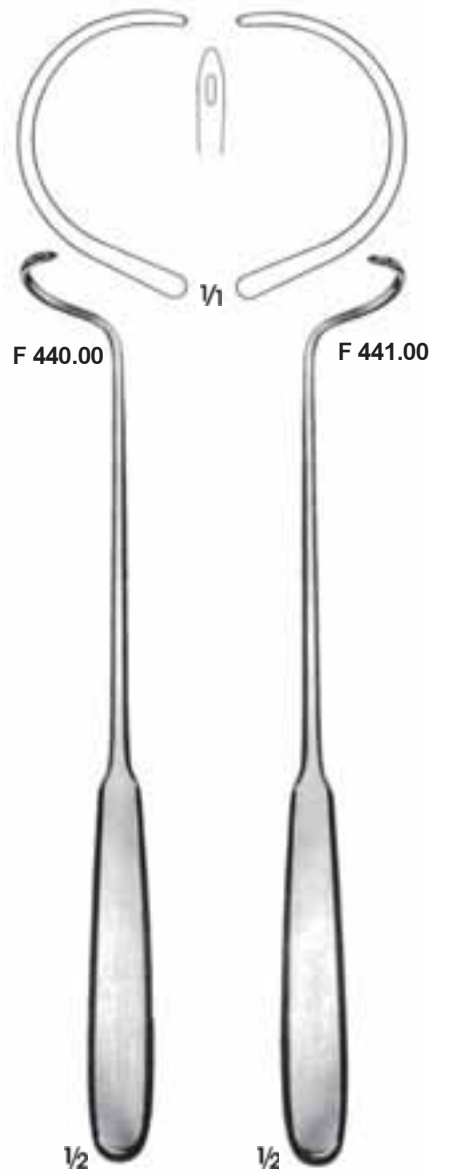

F 440.00

1/2

F 441.00

1/2

DESCHAMPS
F 440.00 Sağ/Right
F 441.00 Sol/Left
Künt/Blunt
24 cm

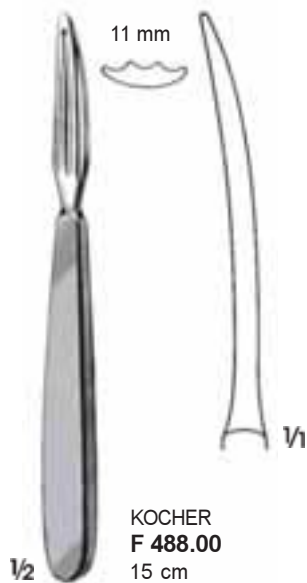

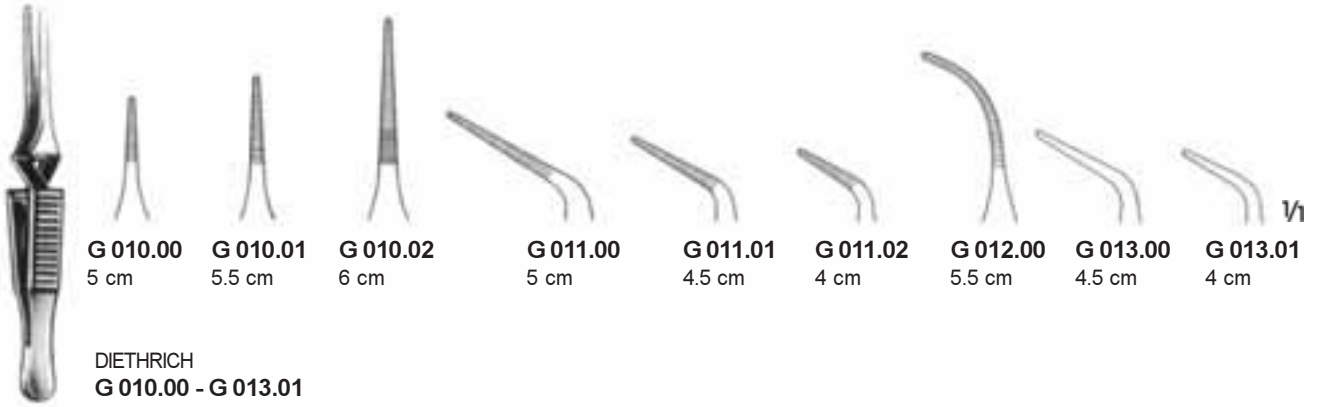

DIEFFENBACH
G 020.00 4 cm
G 020.01 5 cm



DIEFFENBACH
G 021.00 4 cm
G 021.01 5 cm



$\frac{1}{1}$
DIEFFENBACH
G 022.00 6 cm



$\frac{1}{1}$
DIEFFENBACH
G 023.00 6 cm



JOHNS-HOPKINS
G 024.00 38 mm
G 024.01 48 mm
G 024.02 56 mm
G 024.03 63 mm
G 024.04 70 mm
G 024.05 80 mm
G 024.06 91 mm



$\frac{1}{1}$
DE BAKEY-HESS
G 030.00
Uc Uzunluğu : 2 cm
Length of Jaws : 2 cm



$\frac{1}{1}$
DE BAKEY-HESS
G 030.01
Uc Uzunluğu : 3 cm
Length of Jaws : 3 cm



$\frac{1}{2}$
JOHNS-HOPKINS
G 026.00
24 cm



G 200.00 G 201.00 G 204.00 G 205.00 $\frac{1}{2}$

BABY-MOSQUITO
G 200.00 - G 205.00
10 cm

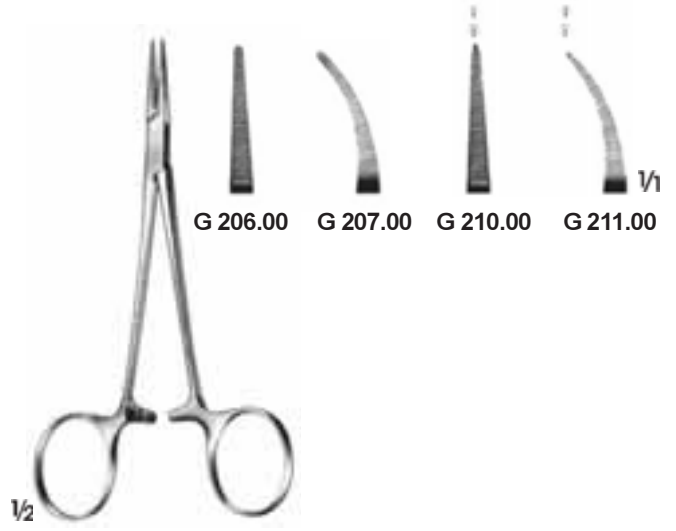

G 206.00 G 207.00 G 210.00 G 211.00 $\frac{1}{2}$

MICRO-HALSTED
G 206.00 - G 211.00
12.5 cm



G 214.00 G 215.00 G 218.00 G 219.00 $\frac{1}{2}$

HALSTED-MOSQUITO
G 214.00 - G 219.00
12.5 cm

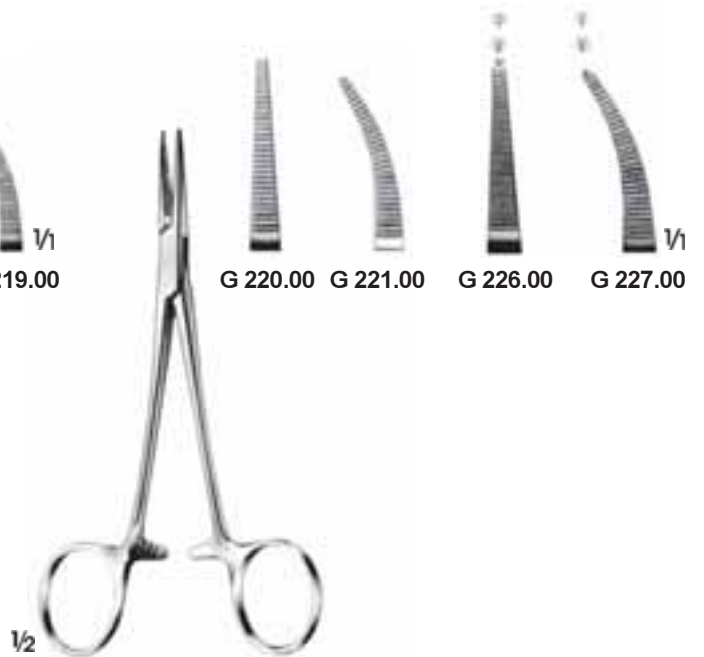

G 220.00 G 221.00 G 226.00 G 227.00 $\frac{1}{2}$

BABY-CRILE
G 220.00 - G 227.00
14 cm

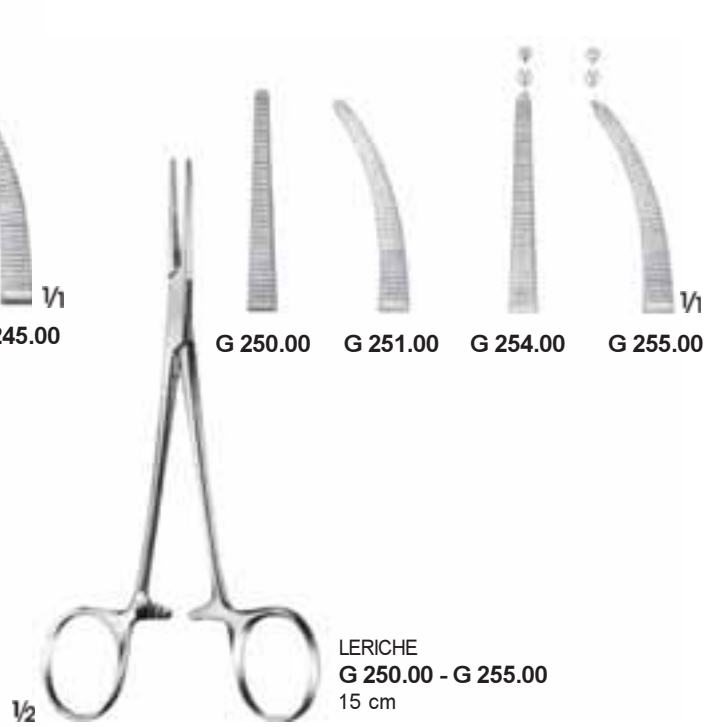

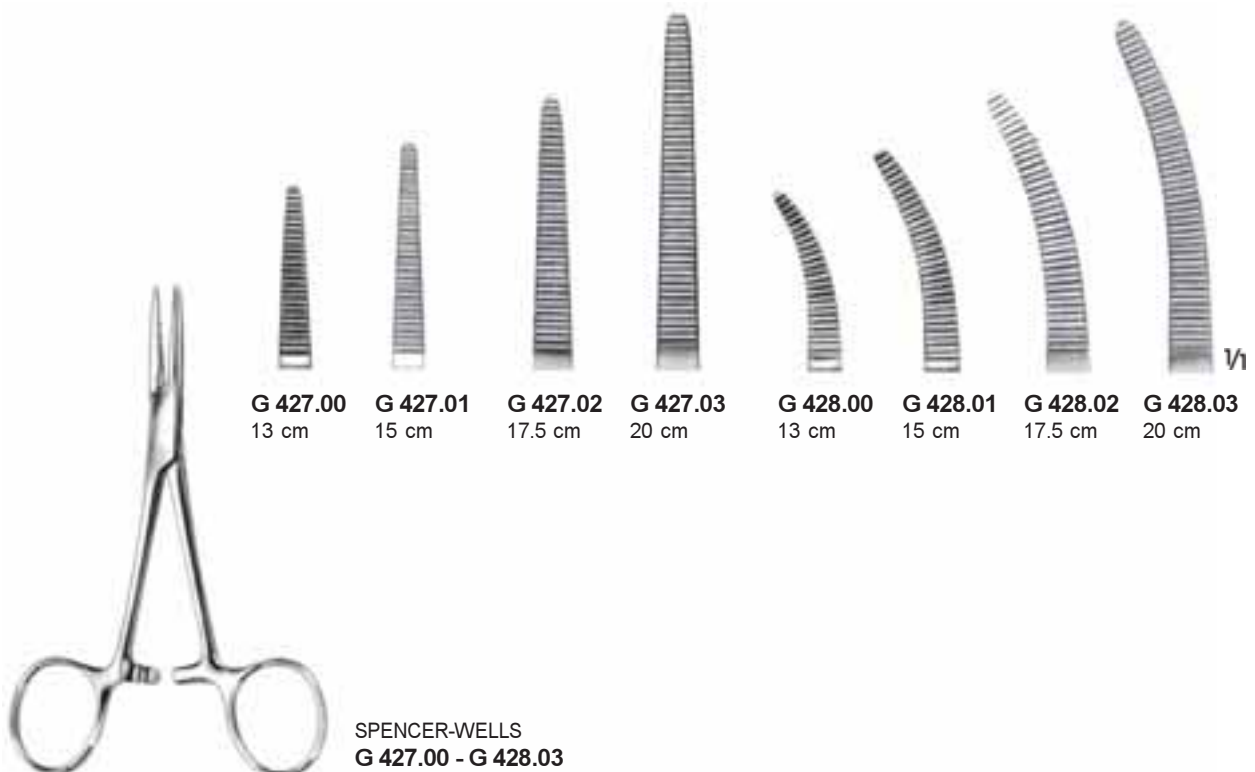
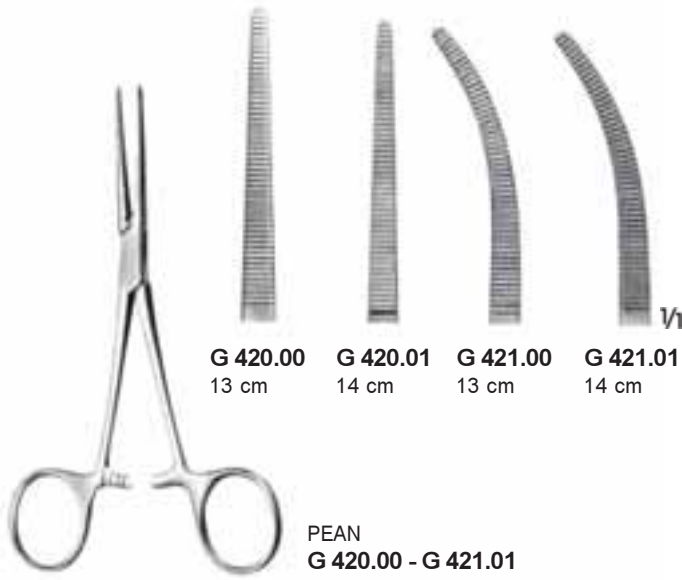

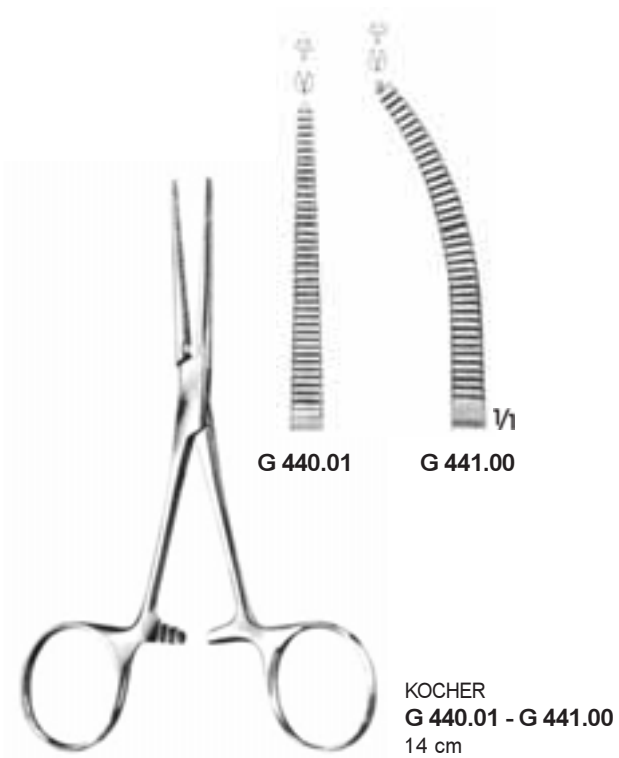

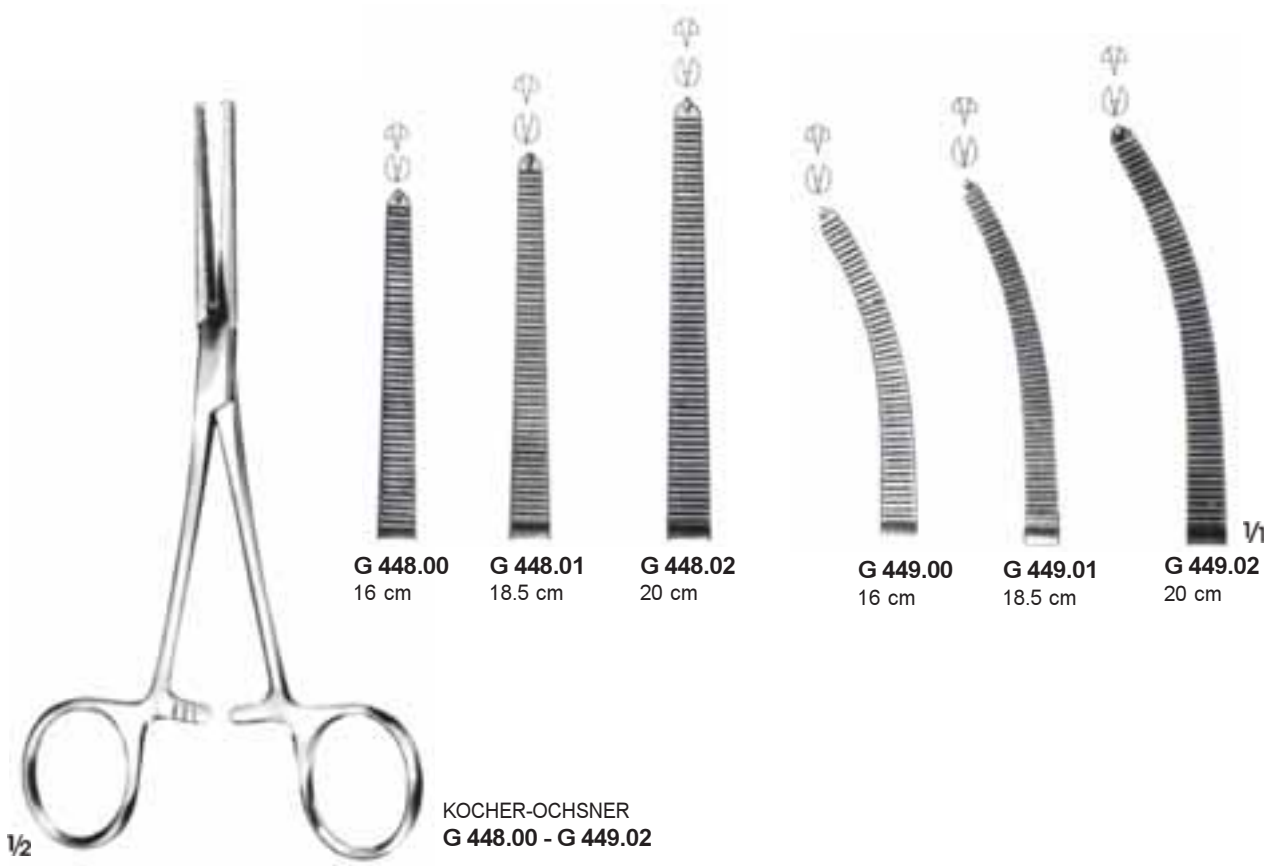
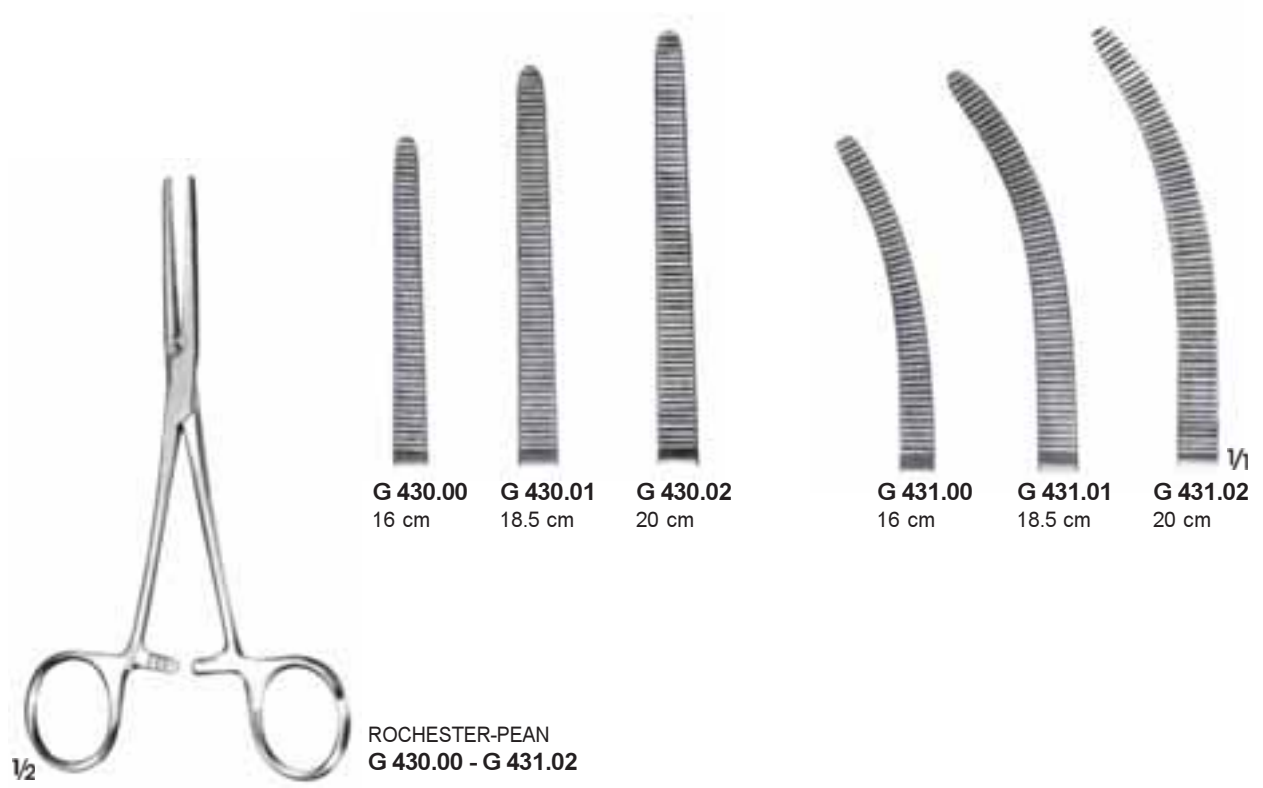



BABY-MIKULICZ
G 690.00
14 cm



MIKULICZ
G 691.00
18.5 cm



G 692.00
18 cm

G 692.01
20.5 cm

MIKULICZ
G 692.00 - G 692.01



MIKULICZ
G 693.00
20.5 cm



MIKULICZ
G 694.00
20.5 cm



MIKULICZ
G 695.00
20 cm



MIKULICZ
G 696.00
20.5 cm



MIKULICZ
G 697.00
20.5 cm



MIKULICZ
G 698.00
18.5 cm



SCHINDLER
G 700.00
20 cm



FAURE
G 701.00 - G 701.01
20.5 cm

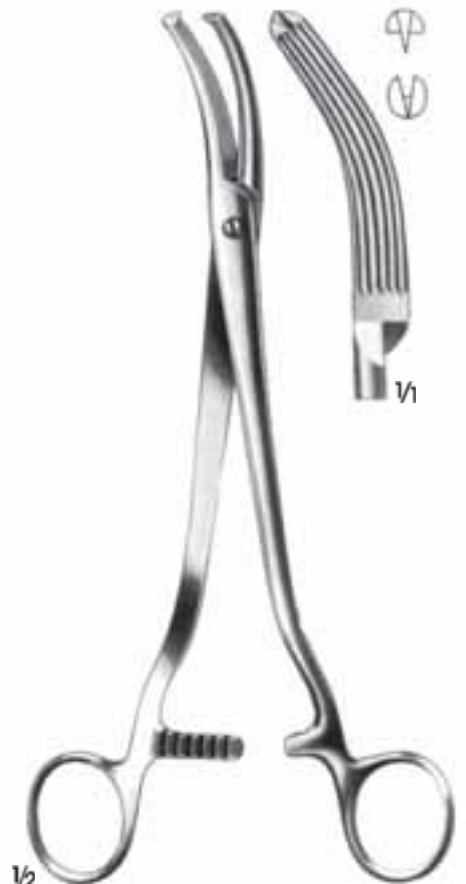

MIKULICZ
G 710.00
24.5 cm



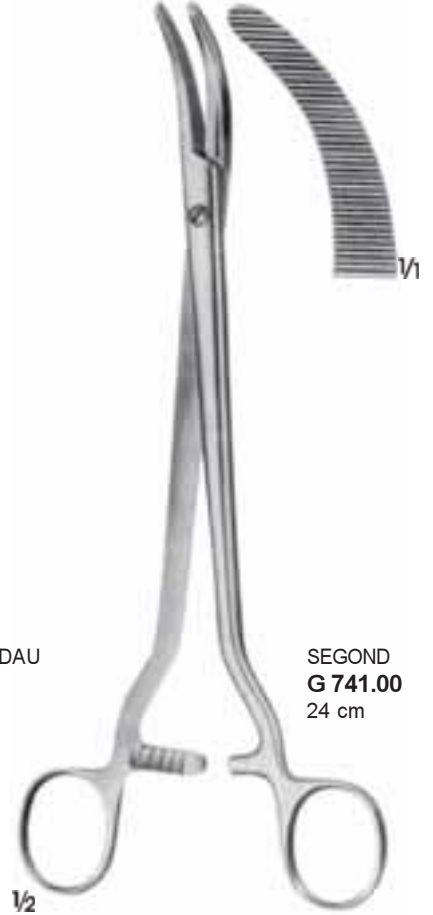
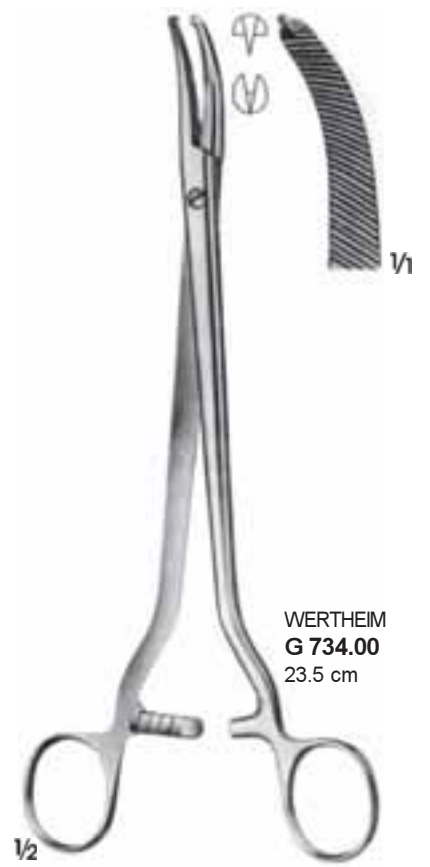



G 750.00
22.5 cm

G 751.00
22 cm

G 752.00
21.5 cm

G 753.00
20.5 cm

HEANEY
G 750.00 - G 753.00



G 754.00
25 cm

G 755.00
24.5 cm

G 756.00
24 cm

G 757.00
22 cm

WERTHEIM
G 754.00 - G 757.00



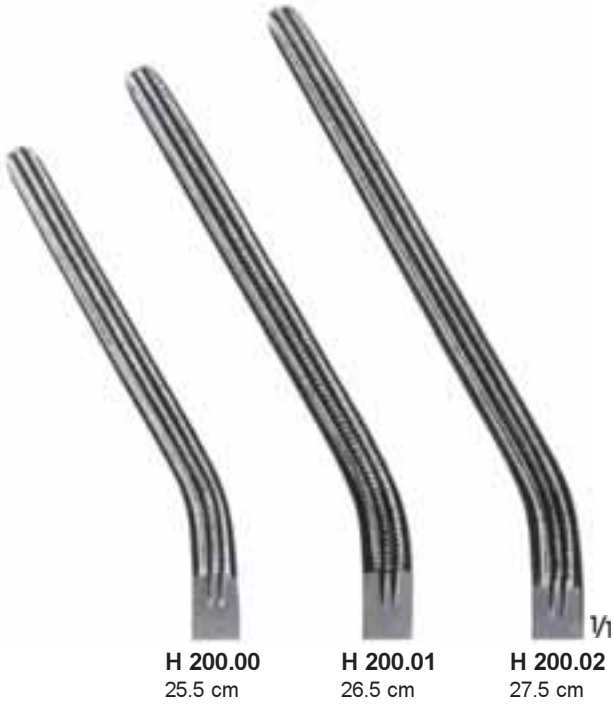



WERTHEIM - CULLEN
G 771.00
21.5 cm



H 204.00 - H 204.01
23 cm

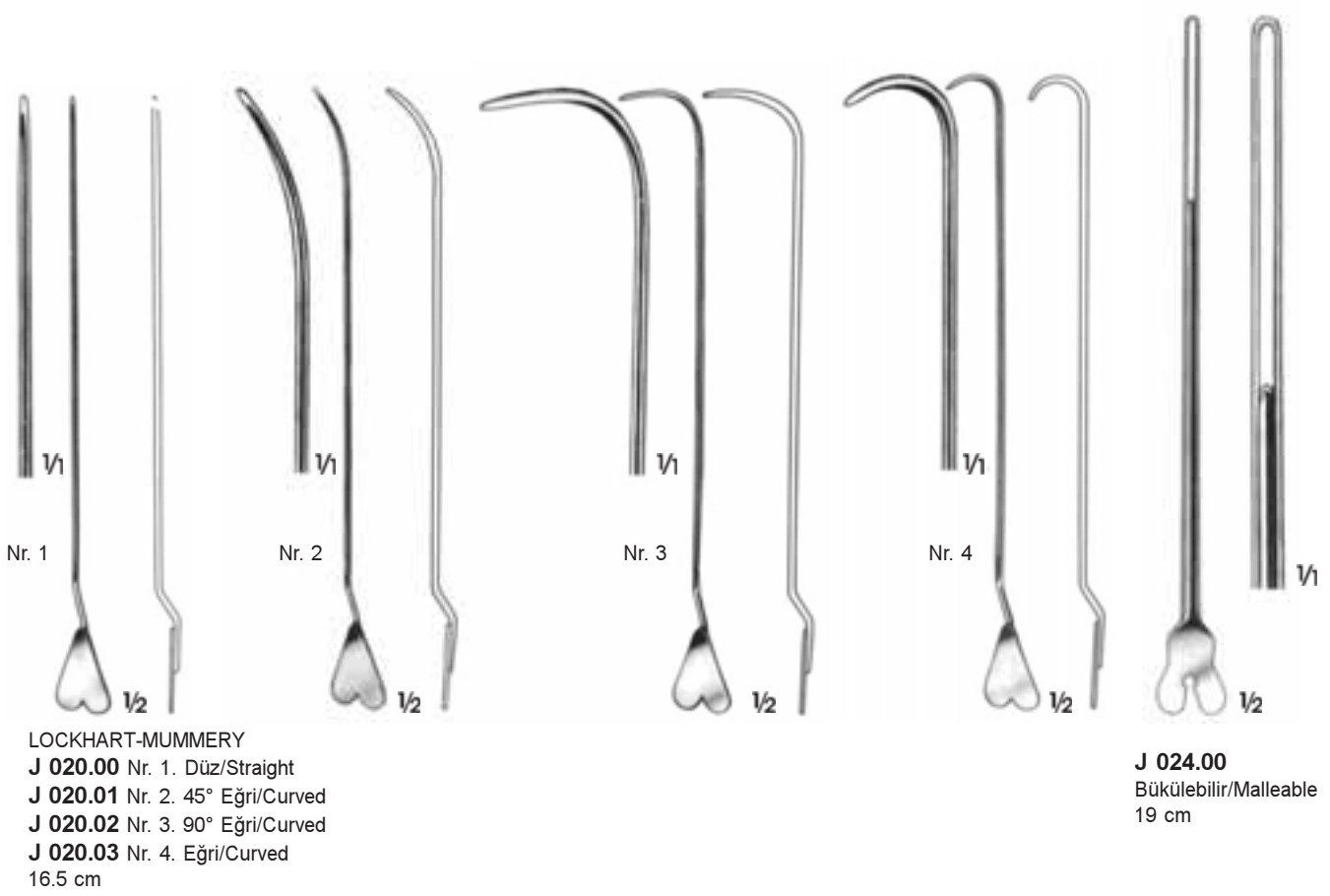

Ø 2.0 mm

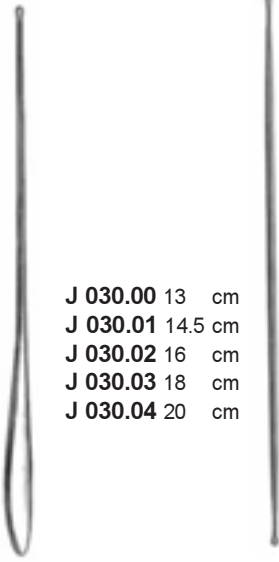

J 030.00 13 cm
J 030.01 14.5 cm
J 030.02 16 cm
J 030.03 18 cm
J 030.04 20 cm

Uc çapı
Diameter of tips

1 mm	1.5 mm	2 mm	Uzunluk Lenght
-	J 033.07	-	13 cm
J 033.01	J 033.08	J 033.15	14.5 cm
-	J 033.09	J 033.16	16 cm
-	J 033.10	J 033.17	18 cm
-	J 033.11	J 033.18	20 cm
-	J 033.12	-	25 cm
-	-	J 033.20	30 cm

J 033.01 - J 033.20

Ø 3 mm



J 035.00 Ø 2 mm
J 035.01 Ø 2.5 mm
J 035.02 Ø 3.0 mm

J 035.00 14.5 cm
J 035.01 16 cm
J 035.02 20 cm

J 037.00
Bükülebilir/Malleable
19 cm

Ø 3.5 mm



J 038.00 25 cm
J 038.01 30 cm
Bükülebilir/Malleable

Ø 4 mm



J 039.00
Bükülebilir/Malleable
40 cm



J 040.00 Ø 1.5 mm
J 040.01 Ø 2.0 mm
J 040.02 Ø 2.5 mm
Bükülebilir/Malleable
30 cm



J 041.00



J 069.00
18 cm

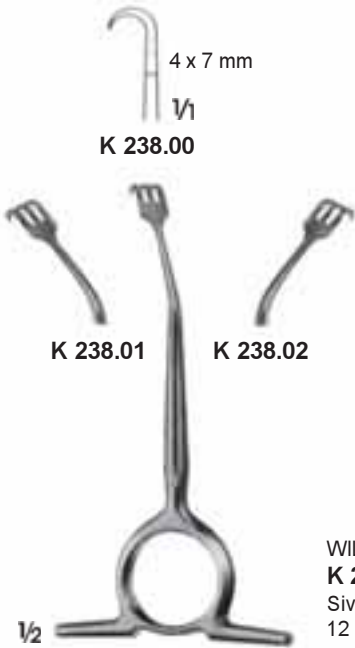

WILLIGER
K 238.00 - K 238.02
Sivri/Sharp
12 cm



SIMON
K 221.00
22 cm



SIMON
K 223.00
22 cm



KOCHER
K 276.00 - K 276.01
20.5 cm

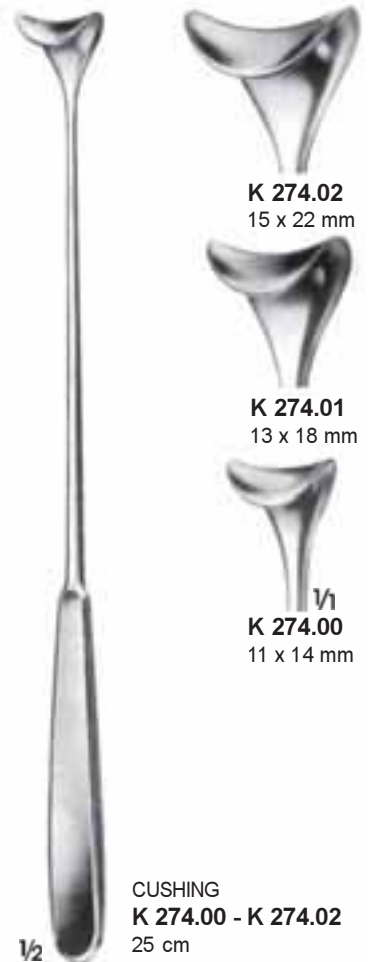

CUSHING
K 274.00 - K 274.02
25 cm

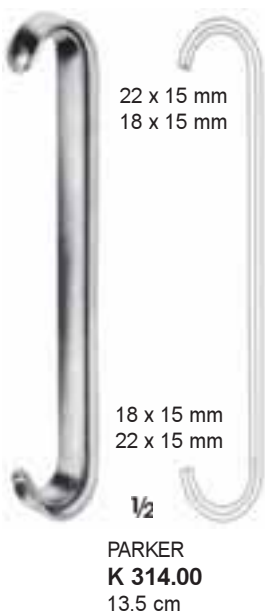

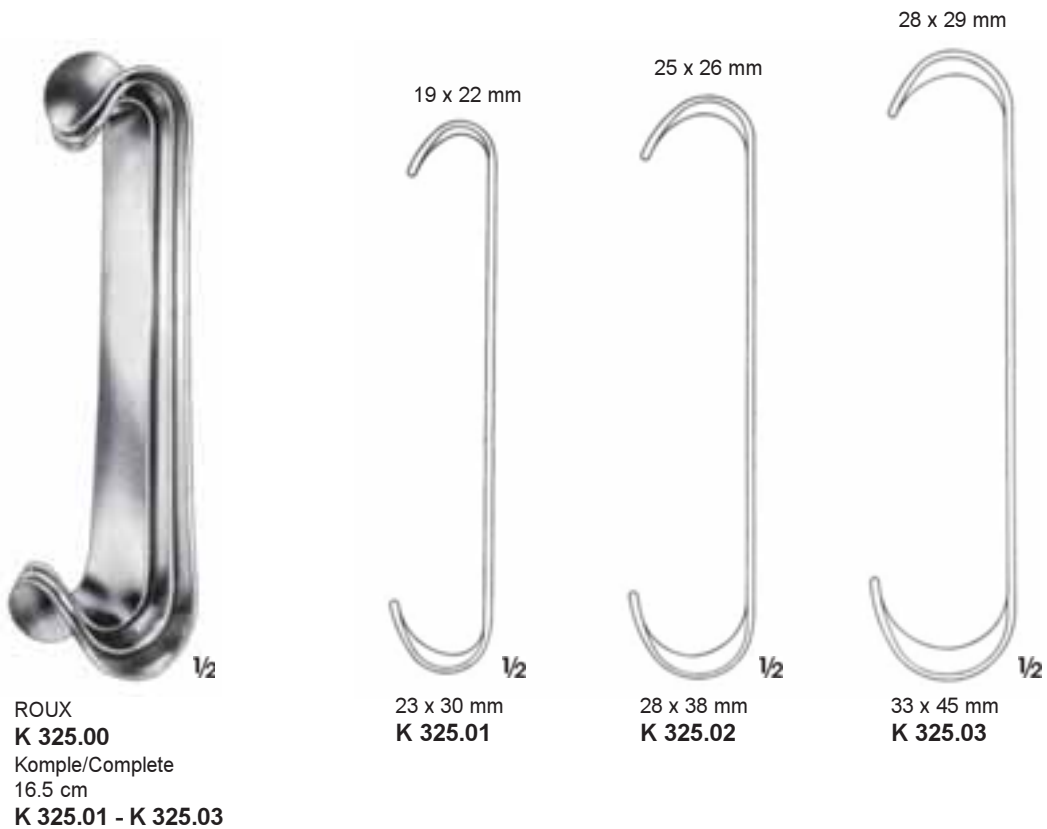
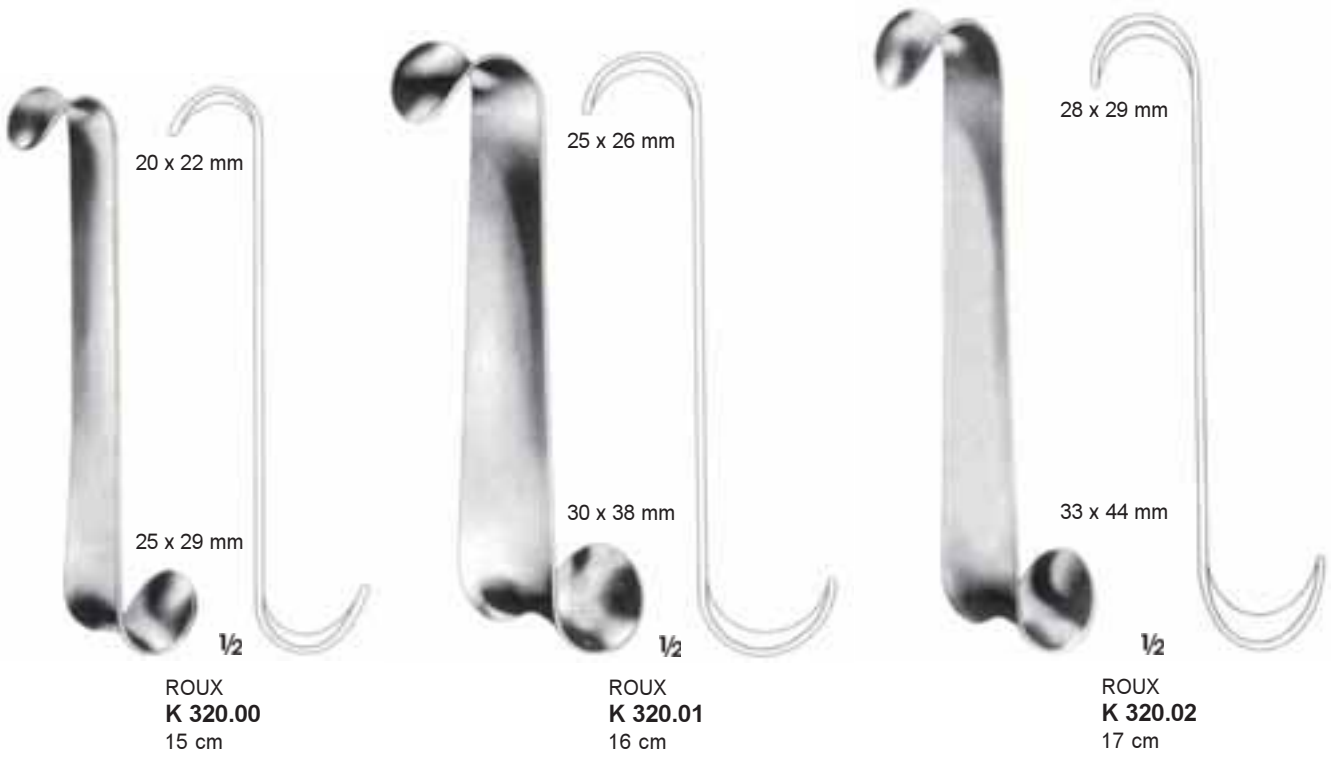

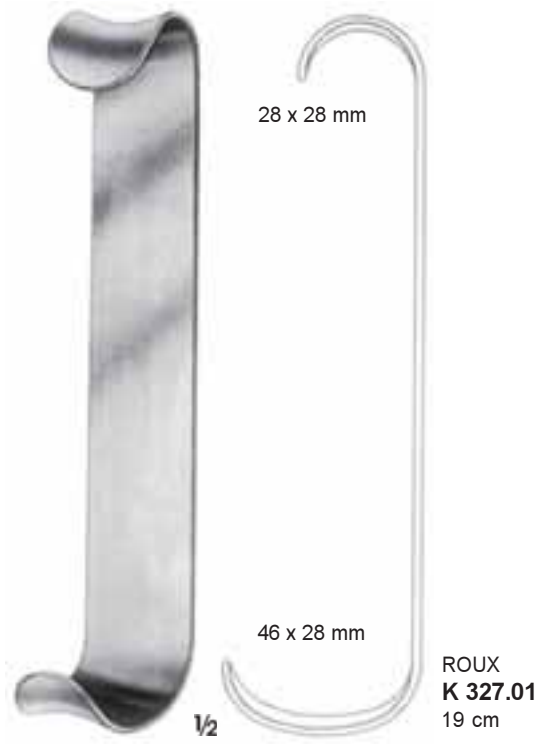



Sivri
Sharp



K 432.00
9 x 8 mm



K 432.01
9 x 13 mm



K 432.02
9 x 19 mm



K 432.03
9 x 29 mm



K 432.04
9 x 40 mm

Künt
Blunt



K 433.00
8 x 8 mm



K 433.01
8 x 13 mm



K 433.02
8 x 19 mm



K 433.03
8 x 29 mm



K 433.04
8 x 40 mm

Yarı sivri
Semi sharp



K 434.00
8.5 x 8 mm



K 434.01
8.5 x 13 mm



K 434.02
8.5 x 19 mm



K 434.03
8.5 x 29 mm

VOLKMANN
K 432.00 - K 432.04
K 433.00 - K 433.04
K 434.00 - K 434.03
22 cm

1/2



Yarı sivri
Semi sharp



K 435.00
16 x 9 mm



K 435.01
16 x 14 mm



K 435.02
16 x 20 mm



K 435.03
16 x 30 mm

Künt
Blunt



K 436.00
15.5 x 9 mm



K 436.01
15.5 x 14 mm



K 436.02
15.5 x 20 mm



K 436.03
15.5 x 30 mm

KOCHER
K 435.00 - K 435.03
K 436.00 - K 436.03
22 cm

1/2



K 440.00
45 x 55 mm

KÖRTE
K 440.00
Künt/Blunt
23 cm

1/2

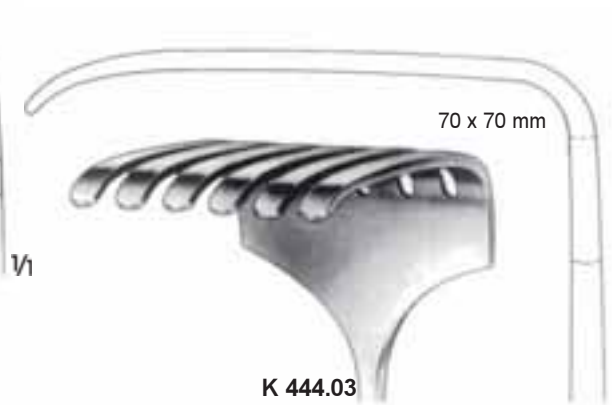

70 x 70 mm

K 444.03

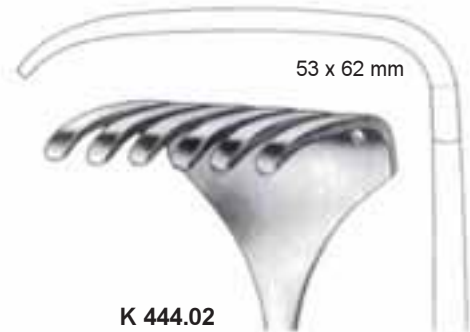

53 x 62 mm

K 444.02



K 442.00
35 x 55 mm

OLLIER
K 442.00
Künt/Blunt
23 cm

1/2



ISRAEL
K 444.00 - K 444.03
Künt/Blunt
23 cm

1/2

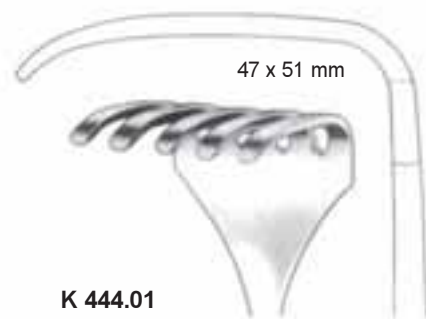

47 x 51 mm

K 444.01

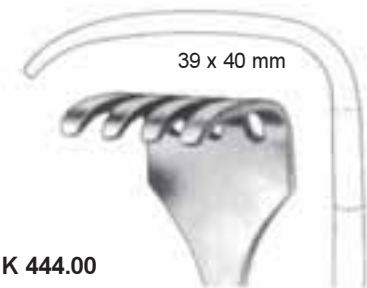

39 x 40 mm

K 444.00

1/2



KOCHER
K 460.00 - K 460.04
23 cm

1/2

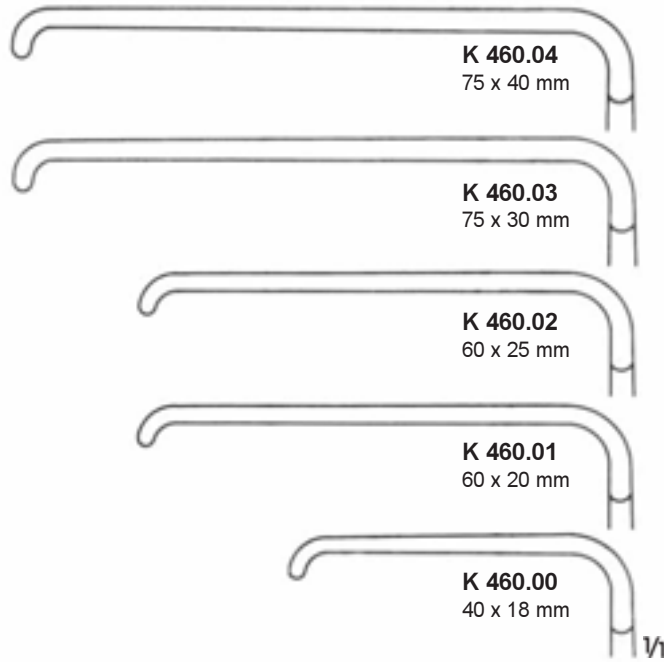

K 460.04
75 x 40 mm

K 460.03
75 x 30 mm

K 460.02
60 x 25 mm

K 460.01
60 x 20 mm

K 460.00
40 x 18 mm

1/1



SAUERBRUCH
K 461.00 - K 461.02
22.5 cm

1/2

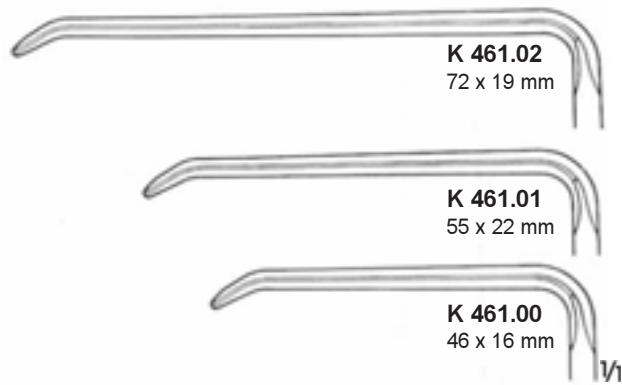

K 461.02
72 x 19 mm

K 461.01
55 x 22 mm

K 461.00
46 x 16 mm

1/1



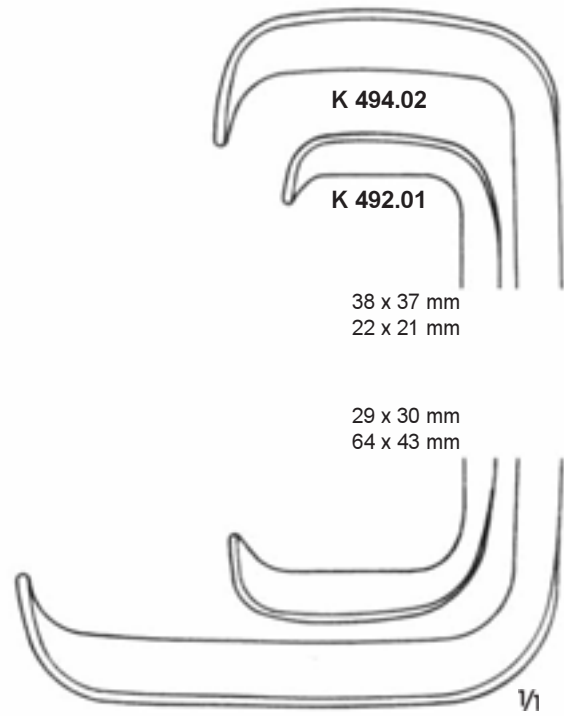
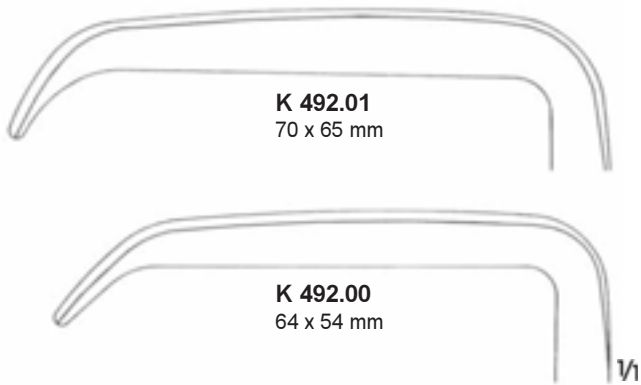

KELLY
K 492.00 - K 492.01
26 cm



RICHARDSON-EASTMAN
K 494.00
Komple/Complete
K 494.01 25 cm
K 494.02 27 cm



K 608.03
94 x 36 mm

K 608.02
64 x 25 mm

K 608.01
36 x 20 mm

K 608.00
20 x 15 mm

KOCHER-WAGNER
K 608.00 - K 608.03
28 cm

1/2







25 mm

1/2

DEAVER
K 668.04
31 cm



38 mm

1/2

DEAVER
K 668.05
31 cm



25 mm

1/2

DEAVER
K 668.06
33 cm



50 mm

1/2

DEAVER
K 668.07
30.5 cm



75 mm

1/2

DEAVER
K 668.08
31 cm





46 mm

1/2

KÜMMEL
K 673.00
33 cm



46 mm

1/2

KÜMMEL
K 672.00
28.5 cm

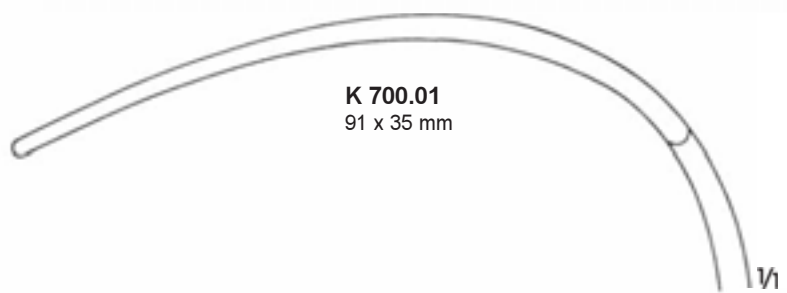
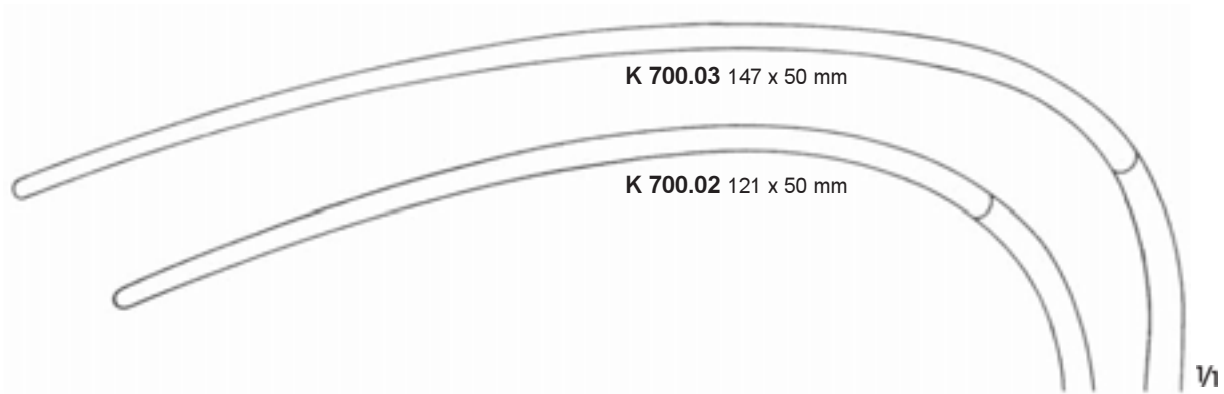

1/2
MIKULICZ
K 700.01
25 cm



1/2
MIKULICZ
K 700.02 - K 700.03
25 cm

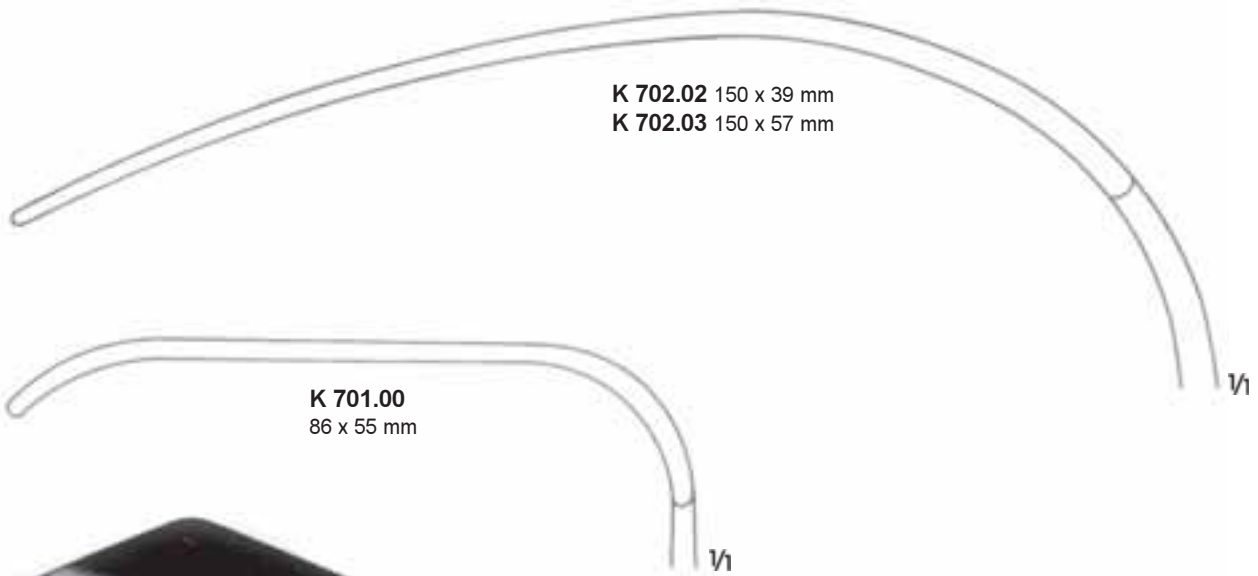

1/2
MIKULICZ
K 701.00
25.5 cm



1/2
MIKULICZ
K 702.02 150 x 39 mm
K 702.03 150 x 57 mm

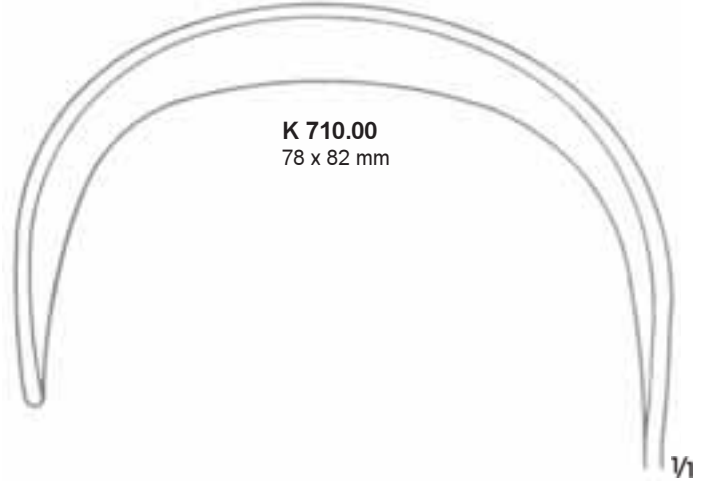

DOYEN
K 709.00
25 cm



DOYEN
K 710.00
26 cm

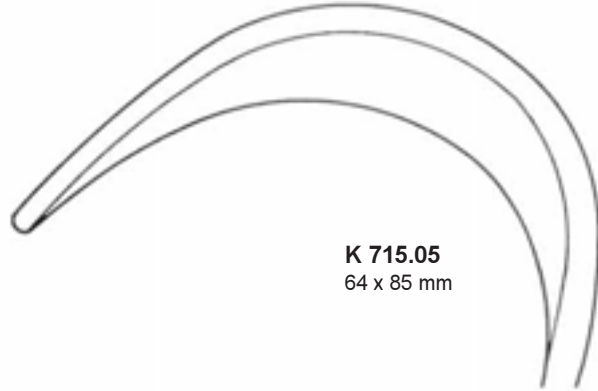

K 715.05
64 x 85 mm

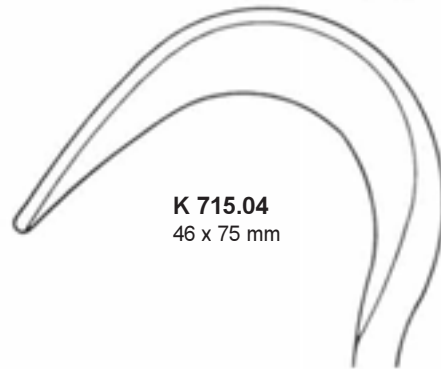

K 715.04
46 x 75 mm

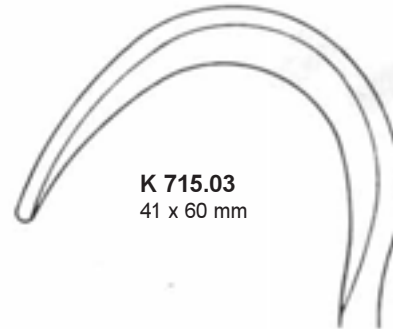

K 715.03
41 x 60 mm



K 715.02
34 x 50 mm

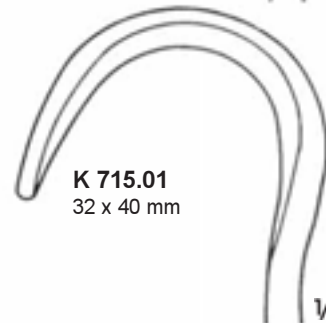

K 715.01
32 x 40 mm



1/2

FRITSCH
K 715.01 - K 715.05
24 cm

1/1



K 752.00 200 x 12 mm
K 752.01 200 x 17 mm
K 752.02 250 x 25 mm
Bükülebilir/Malleable



TUFFIER
K 754.00
Bükülebilir/Malleable
20 cm



K 756.00 30 mm
K 756.01 40 mm
K 756.02 50 mm
Bükülebilir/Malleable
33 cm



K 758.00 30 mm
K 758.01 40 mm
K 758.02 50 mm
K 758.03 60 mm
K 758.04 70 mm
Bükülebilir/Malleable
41 cm

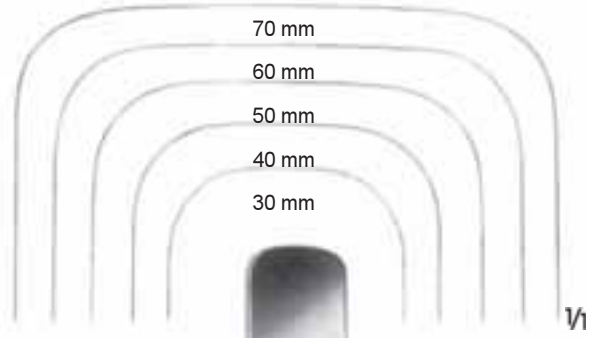

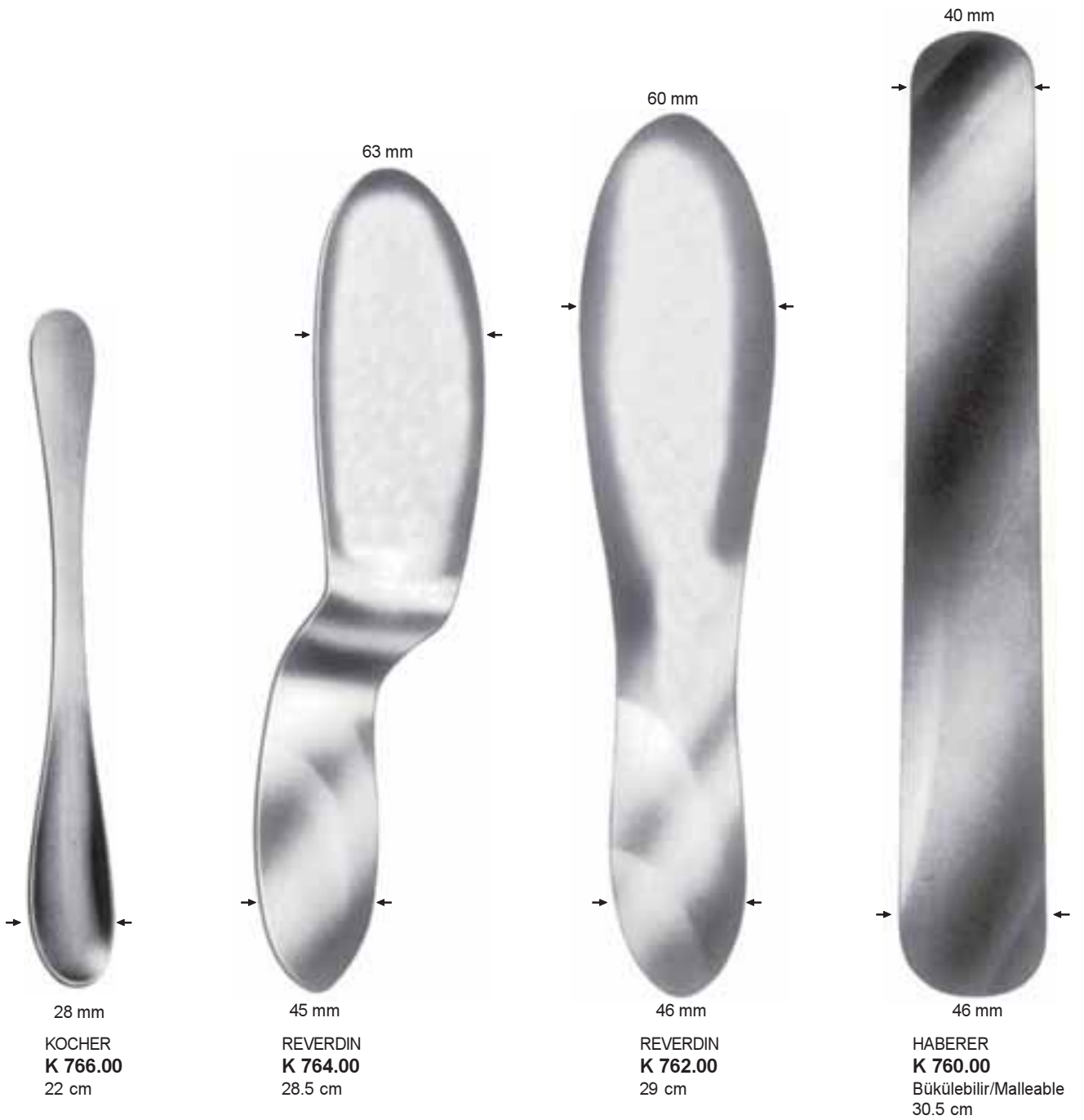



BABY-COLLIN
L 500.00



COLLIN
L 501.00 Komple/Complete
L 501.01 Sadece ekartör
Retractor only
L 560.00 Yan bleyd
Lateral blades



COLLIN
L 503.01 - L 503.03



COLLIN
L 502.00 - L 502.01

	L 503.01	L 503.02	L 503.03
Sadece ekartör Retractor only	L 503.06	L 503.07	L 503.07
Yan bleyd	L 560.00	L 560.01	L 560.02
Lateral blades	37 x 62 mm	37 x 80 mm	37 x 98 mm
Orta bleyd	L 580.03	L 580.04	L 580.05
Center Blade	54 x 55 mm	54 x 67 mm	52 x 76 mm

	L 502.00	L 502.01
Sadece ekartör Retractor only	L 502.04	L 502.04
Yan bleyd	L 560.04	L 560.03
Lateral blades	48 x 59 mm	61 x 80 mm
Orta bleyd	L 580.00	L 580.00
Center Blade	63 x 74 mm	63 x 74 mm

32 cm



RICARD
L 506.00 - L 506.01

	L 506.00	L 506.01
Sadece ekartör Retractor only	L 506.04	L 506.04
Yan bleyd Lateral blades	L 560.05	L 560.06
Orta bleyd Center Blade	58 x 80 mm L 580.10	72 x 84 mm L 580.11

26.5 cm



ROBIN-MASSE
L 505.00
Komple/Complete

Sadece ekartör Retractor only	L 505.01
Yan bleyd Lateral blades	L 560.00 37 x 62 mm
Orta bleyd Center Blade	L 580.08 38 x 68 mm

27.5 cm



HOLZBACH
L 508.00
Komple/Complete

Sadece ekartör Retractor only	L 508.01
Yan bleyd Lateral blades	L 560.07 59 x 80 mm
Orta bleyd Center Blade	L 580.16 74 x 82 mm



L 560.04 48 x 54 mm
L 560.05 58 x 80 mm
L 560.06 72 x 84 mm

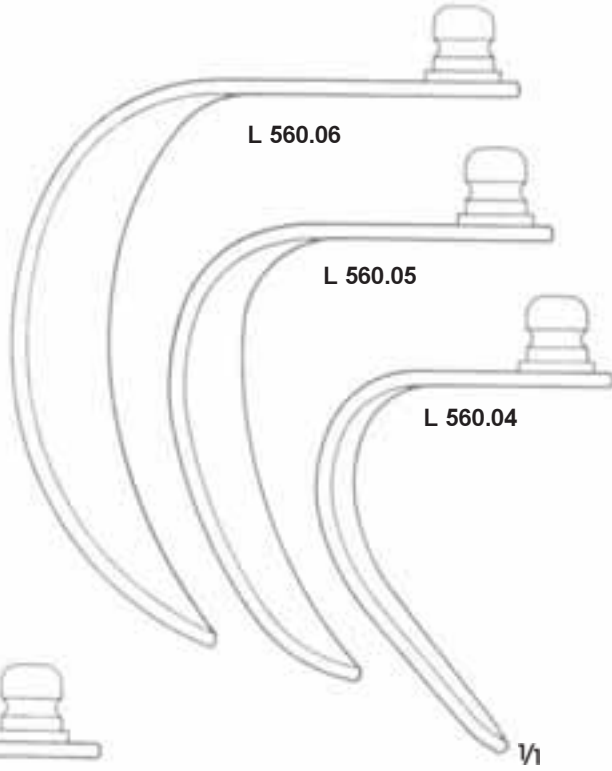

L 560.07 59 x 80 mm

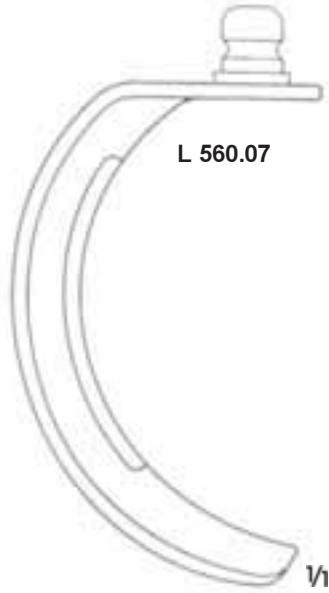

L 560.00 37 x 62 mm
L 560.01 37 x 80 mm
L 560.02 37 x 98 mm

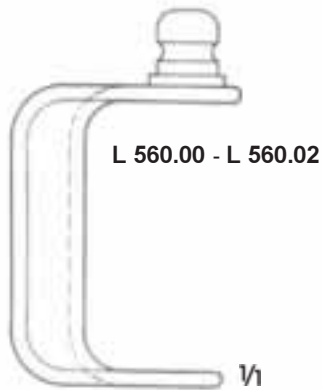

L 560.03 61 x 80 mm

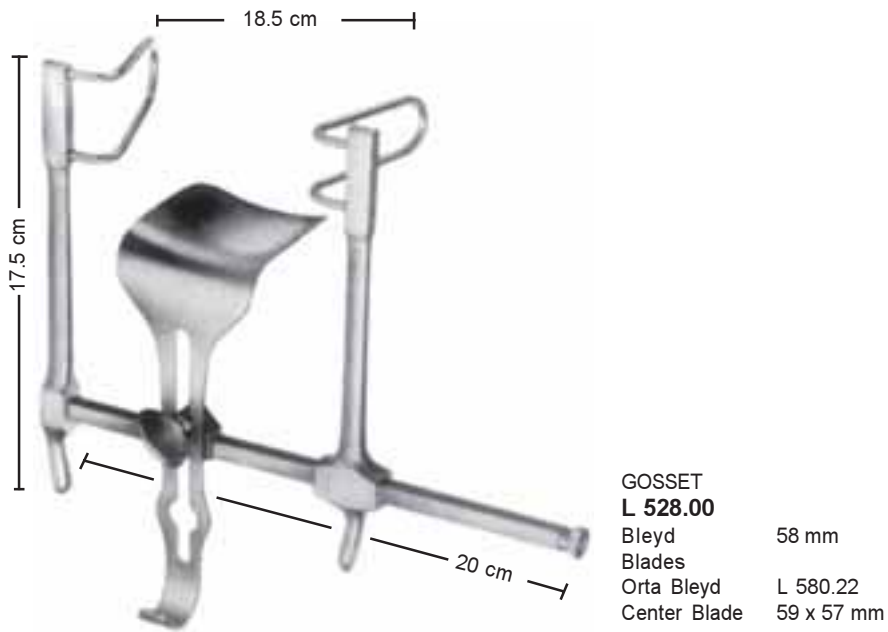
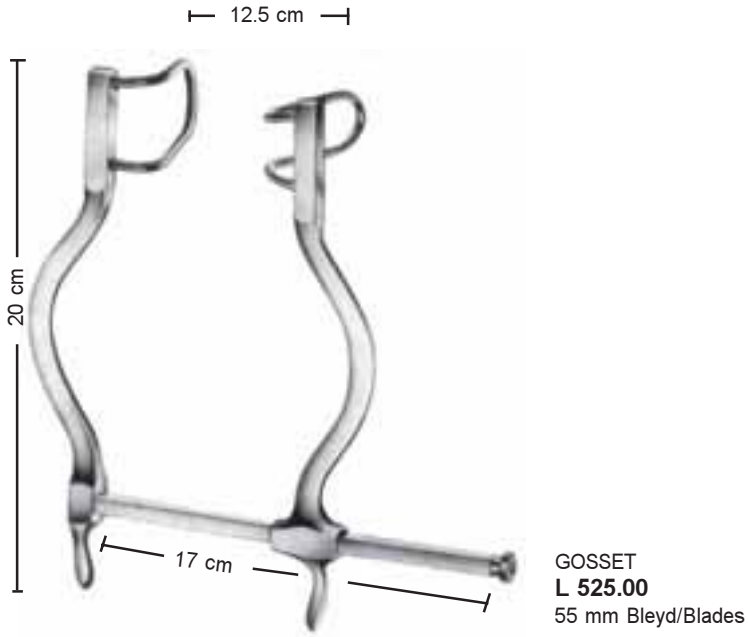

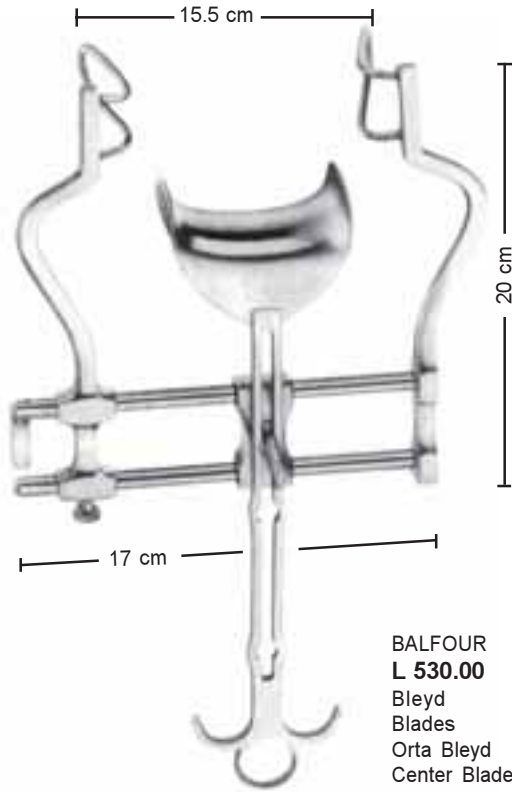

BALFOUR
L 530.00
Bleyd 60 mm
Blades
Orta Bleyd L 580.25
Center Blade 47 x 80 mm

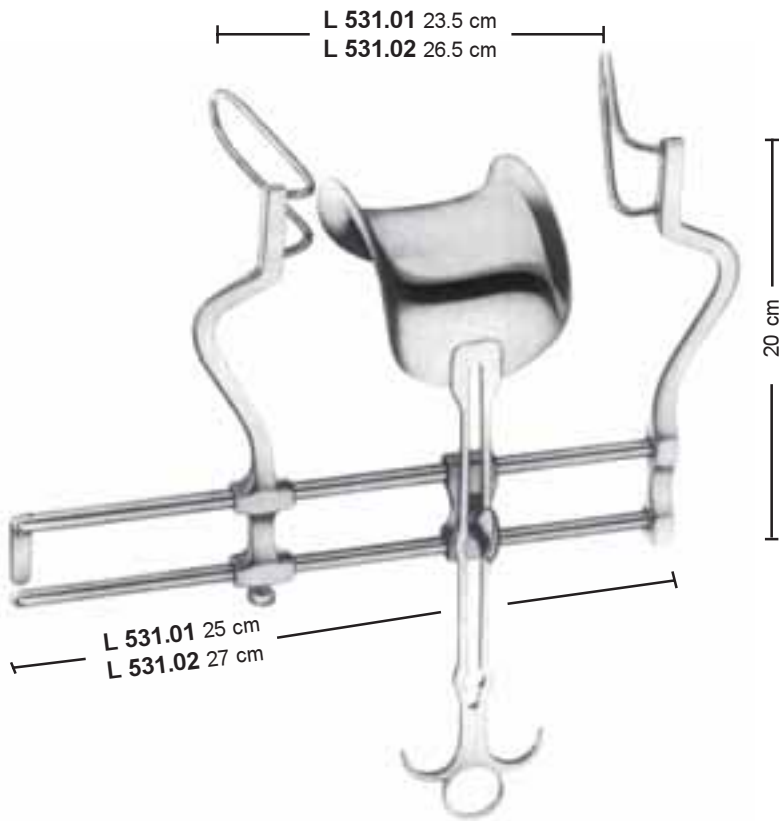

BALFOUR
L 531.01 - L 531.02

	L 531.01	L 531.02
Yan bleyd Lateral blades	60 mm	90 mm
Orta bleyd Center Blade	L 580.26	L 580.27
	62 x 76 mm	80 x 80 mm

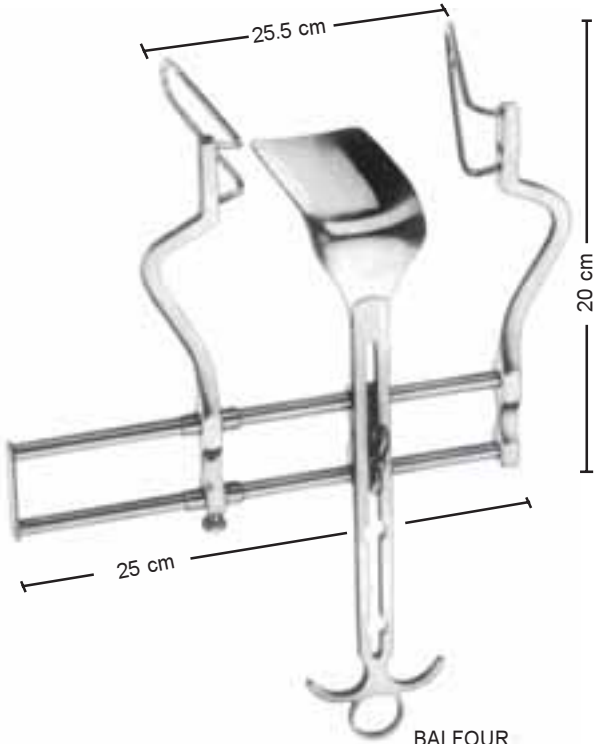

BALFOUR
L 532.01
Yan Bleyd 105 mm
Lateral Blades
Orta Bleyd L 580.23
Center Blade 107 x 59 mm



L 580.30
Orta Bleyd/Center Blade
54 x 80 mm



L 580.40
Orta Bleyd/Center Blade
75 x 80 mm

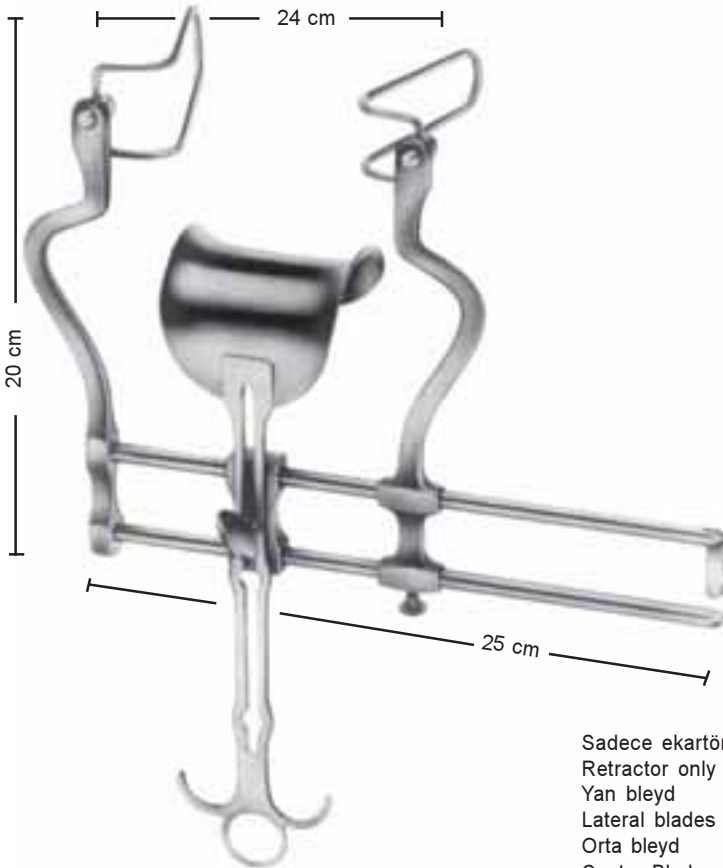

BALFOUR
L 534.00 - L 534.03
Komple/Complete

	L 534.00	L 534.01	L 534.02	L 534.03
Sadece ekartör Retractor only	L 534.20	L 534.20	L 534.20	L 534.20
Yan bleyd Lateral blades	L 560.10 50 mm	L 560.11 60 mm	L 560.12 75 mm	L 560.13 90 mm
Orta bleyd Center Blade	L 580.25 47 x 80 mm	L 580.26 62 x 76 mm	L 580.27 80 x 80 mm	L 580.27 80 x 80 mm



L 560.10 50 mm
L 560.11 60 mm
L 560.12 75 mm
L 560.13 90 mm
Yan Bleyd/Lateral Blades

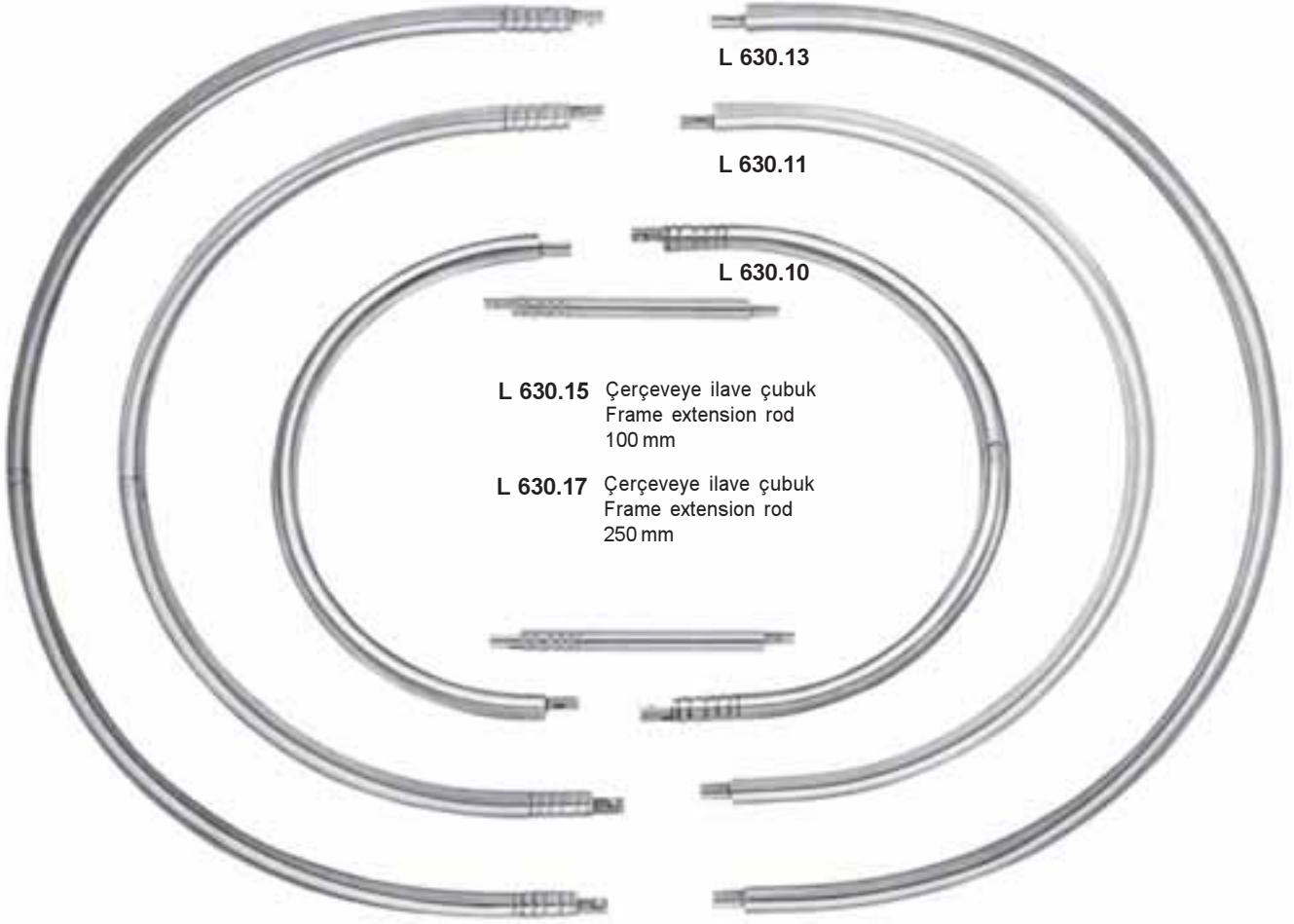

L 630.15 Çerçeveye ilave çubuk
Frame extension rod
100 mm

L 630.17 Çerçeveye ilave çubuk
Frame extension rod
250 mm

L 630.10
Sökülebilir batin çemberi
Abdominal frame, detachable
238 x 180 mm

L 630.11
Sökülebilir batin çemberi
Abdominal frame, detachable
328 x 270 mm

L 630.13
Sökülebilir batin çemberi
Abdominal frame, detachable
408 x 350 mm

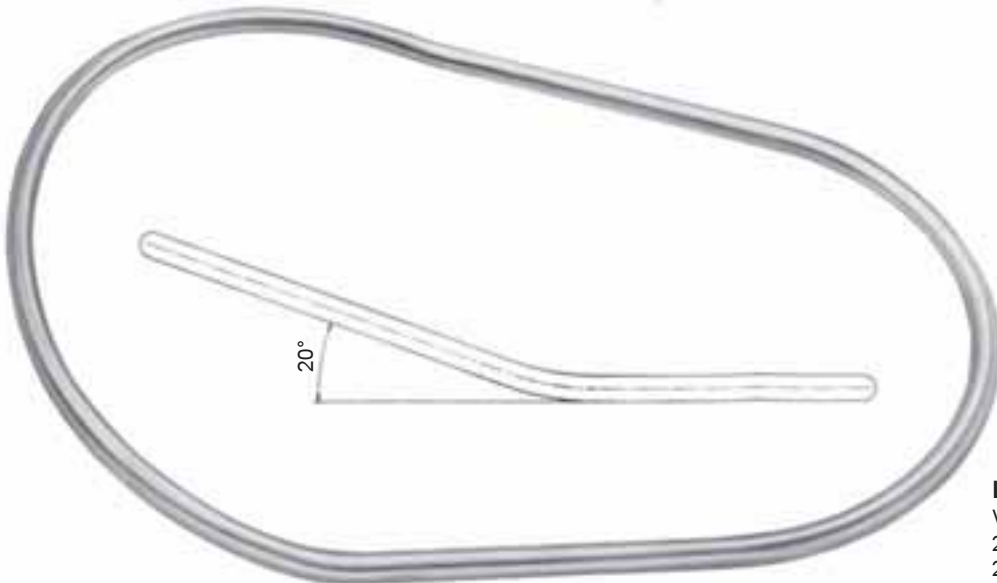

L 630.19
Vajinal çerçeve/Vaginal frame
20° Açılı/20° Angled
270 x 200 mm



L 630.22
Bağlantı Klampi/Connecting clamp



L 630.23
Çentik Çubuğu/Notch rod
15 cm



L 630.24
Çentik bağlantı çubuğu
Extension for notch rod
10 cm



L 630.25
Çentik son bağlantı parçası
Notch rod end part
6 cm



ROCHARD
L 630.29
Adaptör/Adapter



L 630.27
Düz bağlantı çubuğu
Extension rod, smooth
20 cm



K 742.00

Ameliyat masalarının her iki yan demirlerine bağlama için montaj çerçevesi. Daha iyi sağlamlık sağlanmış olmakta olup sterilizasyon için sökülebilir.
Mounting frame for fastening to both sides of the lateral bars of the operating tables, thus more stability is given, can be dismantled for sterilization.



DEAVER
L 630.30
Ekartör/Retractor
85 x 25 mm



MIKULICZ
L 630.31 120 x 50 mm
L 630.32 155 x 50 mm
Ekartör/Retractor



KELLY
L 630.34
Ekartör/Retractor
140 x 40 mm



HARRINGTON
L 630.40
Ekartör/Retractor
130 x 62 mm



L 630.37
Karaciğer ekartörü/Liver Retractor
140 x 85 mm



L 630.38
İdrar kesesi spatulası
Bladder spatula
30° açılı/30° angled
110 x 85 mm



KELLY
L 630.42 63 x 55 mm
L 630.43 70 x 63 mm
Batın Ekartörü/Abdominal Retractor



L 630.45 50 x 90 mm
L 630.46 50 x 105 mm
Batın Ekartörü/Abdominal Retractor



L 630.48 62 x 76 mm
L 630.49 80 x 80 mm
Batın Ekartörü/Abdominal Retractor



L 630.51 30 mm
L 630.52 40 mm
L 630.53 50 mm
L 630.54 85 mm
Batın Spatulası/Abdominal Spatula
Bükülebilir/Malleable
22 cm

**L 630.60**

Vajinal ekartör/Vaginal retractor
Yan bleyd/Lateral blade
25 x 75 mm

**L 630.62**

Vajinal ekartör/Vaginal retractor
Arka bleyd/Posterior blade
25 x 115 mm

**L 630.77**

Kapama ekartörünün adaptörü
Adapter for ball snap closure retractors

**L 630.64 Kullanım Şekli**

Ekartör küreyi kilitleme ekartörü

L 630.77 adaptörü

L 630.23 veya L 630.24 çentik bağlantı çubuğu ve
L 630.25 tamamlayıcı son parça ile kullanılır.

Also valves with ball snap closures can be used.

The retractor consists of a ball snap closure valve
the L 630.77 adapter

a L 630.23 or L 630.24 notch rod
an end piece L 630.25

**L 630.74**

130 x 73
İdrar kesesi ekartörü
Bladder retractor



*L 630.64 37 x 62 mm

*L 630.65 37 x 80 mm

*L 630.66 37 x 98 mm

Batın ekartörü/Abdominal retractor



*L 630.68 48 x 59 mm

*L 630.69 58 x 80 mm

*L 630.70 77 x 84 mm

Batın ekartörü/Abdominal retractor



*L 630.72

59 x 80 mm

Batın ekartörü/Abdominal retractor

* Satış : 1 Çift

* Sales Unit : 1 Pair

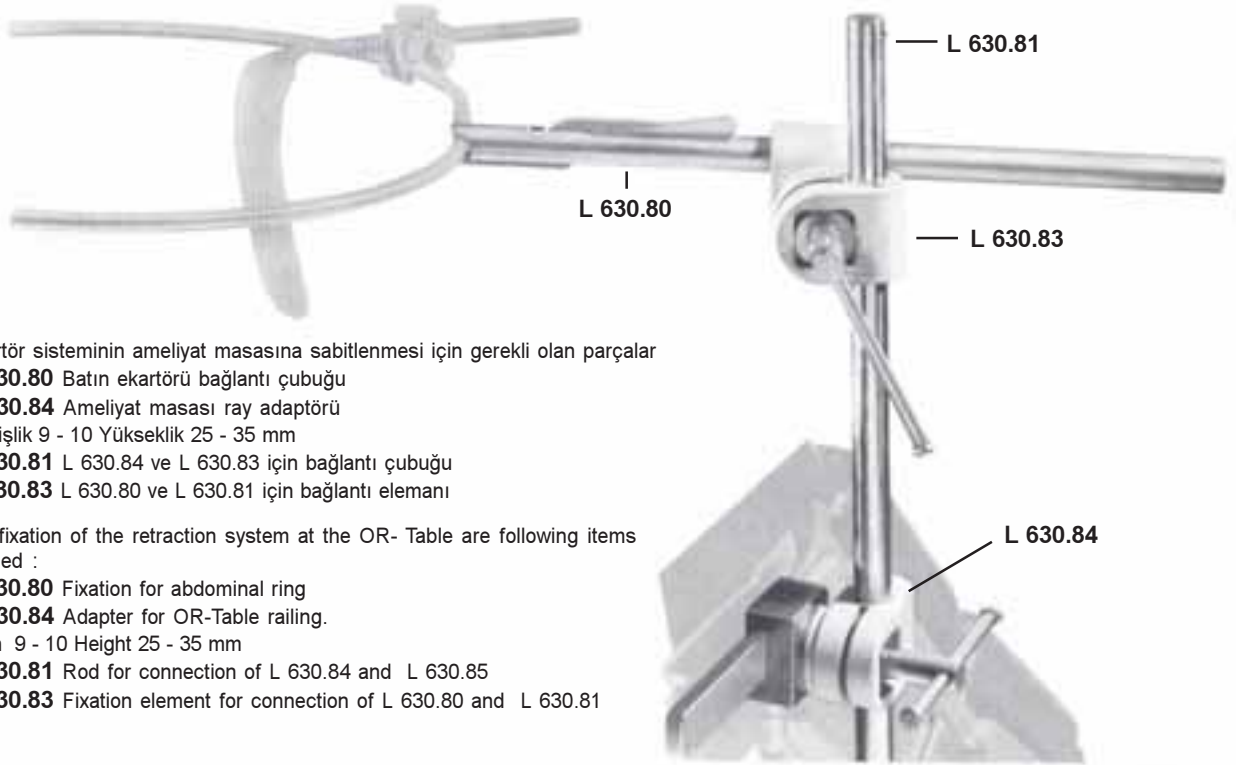

Ekartör sisteminin ameliyat masasına sabitlenmesi için gerekli olan parçalar

L 630.80 Batın ekartörü bağlantı çubuğu

L 630.84 Ameliyat masası ray adaptörü

Genişlik 9 - 10 Yükseklik 25 - 35 mm

L 630.81 L 630.84 ve L 630.83 için bağlantı çubuğu

L 630.83 L 630.80 ve L 630.81 için bağlantı elemanı

For fixation of the retraction system at the OR- Table are following items
requed :

L 630.80 Fixation for abdominal ring

L 630.84 Adapter for OR-Table railing.

With 9 - 10 Height 25 - 35 mm

L 630.81 Rod for connection of L 630.84 and L 630.85

L 630.83 Fixation element for connection of L 630.80 and L 630.81

MÜNSTER Ekartör Sistemi Seti
MUNSTER Retraction System Sets
L 630.90

L 630.11	1 adet/1 each
L 630.13	1 adet/1 each
L 630.22	8 adet/8 each
L 630.23	4 adet/4 each
L 630.24	4 adet/4 each
L 630.25	8 adet/8 each
L 630.27	1 adet/1 each
L 630.29	1 adet/1 each
L 630.30	1 adet/1 each
L 630.31	1 adet/1 each
L 630.32	1 adet/1 each
L 630.34	1 adet/1 each
L 630.37	2 adet/2 each
L 630.45	2 adet/2 each
L 630.46	2 adet/2 each
L 630.60	2 adet/2 each
L 630.62	1 adet/1 each
L 630.64	2 adet/2 each
L 630.72	1 adet/1 each
L 630.77	1 adet/1 each
Y 191.05	2 adet/2 each
Y 110.20	1 adet/1 each

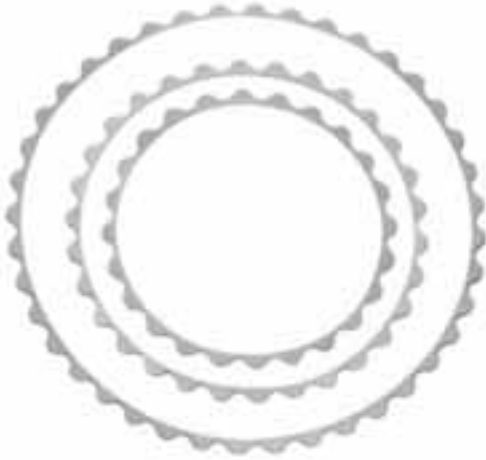

TURNER-WARWICK
L 605.01 Ø 18 cm
L 605.02 Ø 23 cm
L 605.03 Ø 30.5 cm



TURNER-WARWICK
L 605.10 457 x 330 mm



TURNER-WARWICK
L 605.00 Komple/Complete
L 605.01 1 adet/ 1 each
L 605.03 1 adet/ 1 each
L 605.30 2 adet/ 2 each
L 605.40 2 adet/ 2 each
L 605.22 2 adet/ 2 each
L 605.25 2 adet/ 2 each
L 605.27 2 adet/ 2 each
L 605.28 2 adet/ 2 each
L 605.20 2 adet/ 2 each



L 605.20
13 mm



L 605.22
51 x 38 mm



L 605.25
76 x 60 mm



L 605.27
89 x 60 mm



L 605.28
114 x 60 mm



L 605.30
76 x 19 mm



L 605.33
102 x 38 mm



L 605.35
89 x 57 mm



L 605.40
114 x 57 mm

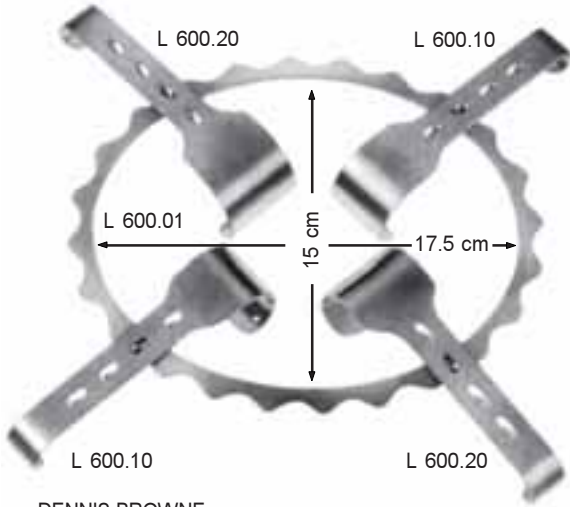

DENNIS-BROWNE

L 600.00

Komple/Complete

L 600.01	175 x 150 mm	Frame/Frame
L 600.10	40 x 30 mm	2 adet bleyd/2 each blades
L 600.20	40 x 40 mm	2 adet bleyd/2 each blades



L 600.30
20 x 30 mm

L 600.32
20 x 40 mm

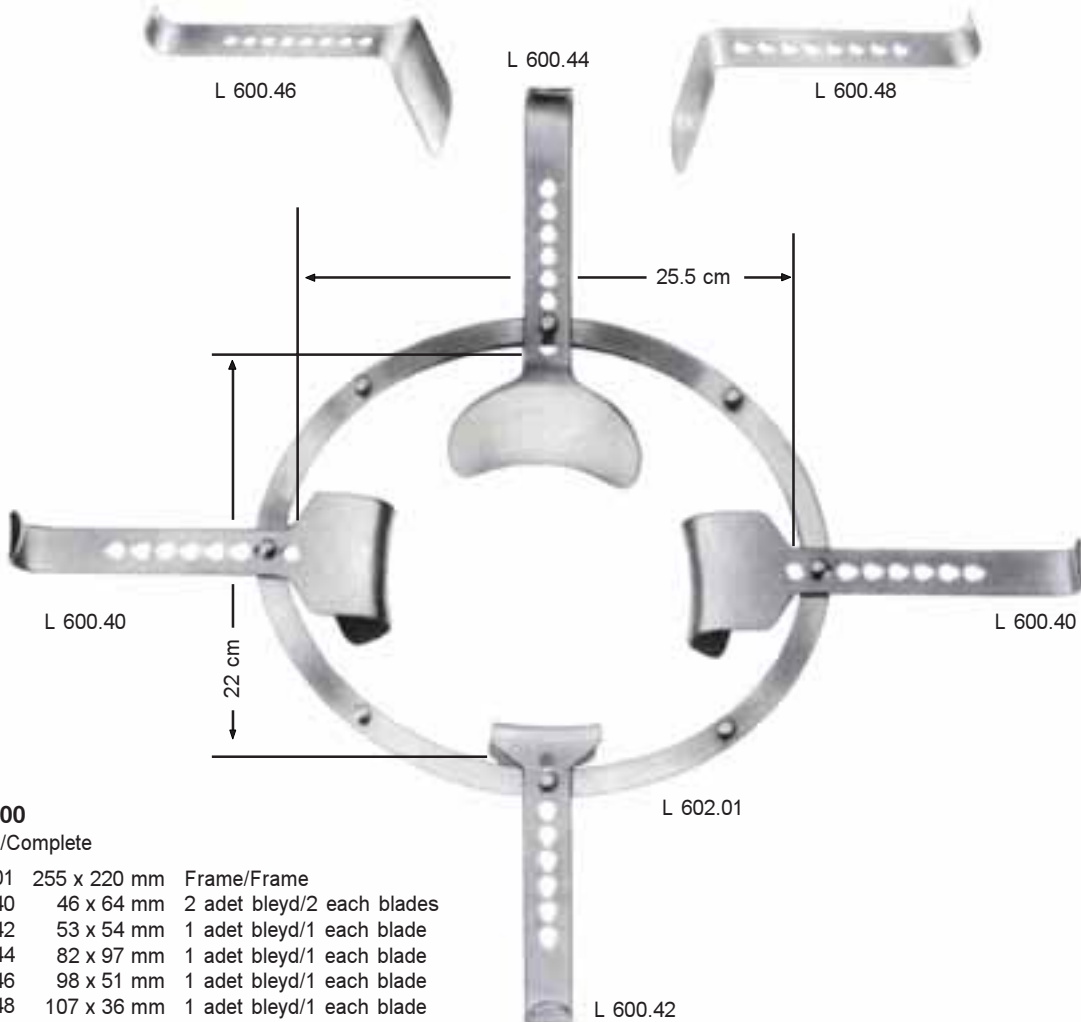

SEMM

L 602.00

Komple/Complete

L 602.01	255 x 220 mm	Frame/Frame
L 600.40	46 x 64 mm	2 adet bleyd/2 each blades
L 600.42	53 x 54 mm	1 adet bleyd/1 each blade
L 600.44	82 x 97 mm	1 adet bleyd/1 each blade
L 600.46	98 x 51 mm	1 adet bleyd/1 each blade
L 600.48	107 x 36 mm	1 adet bleyd/1 each blade

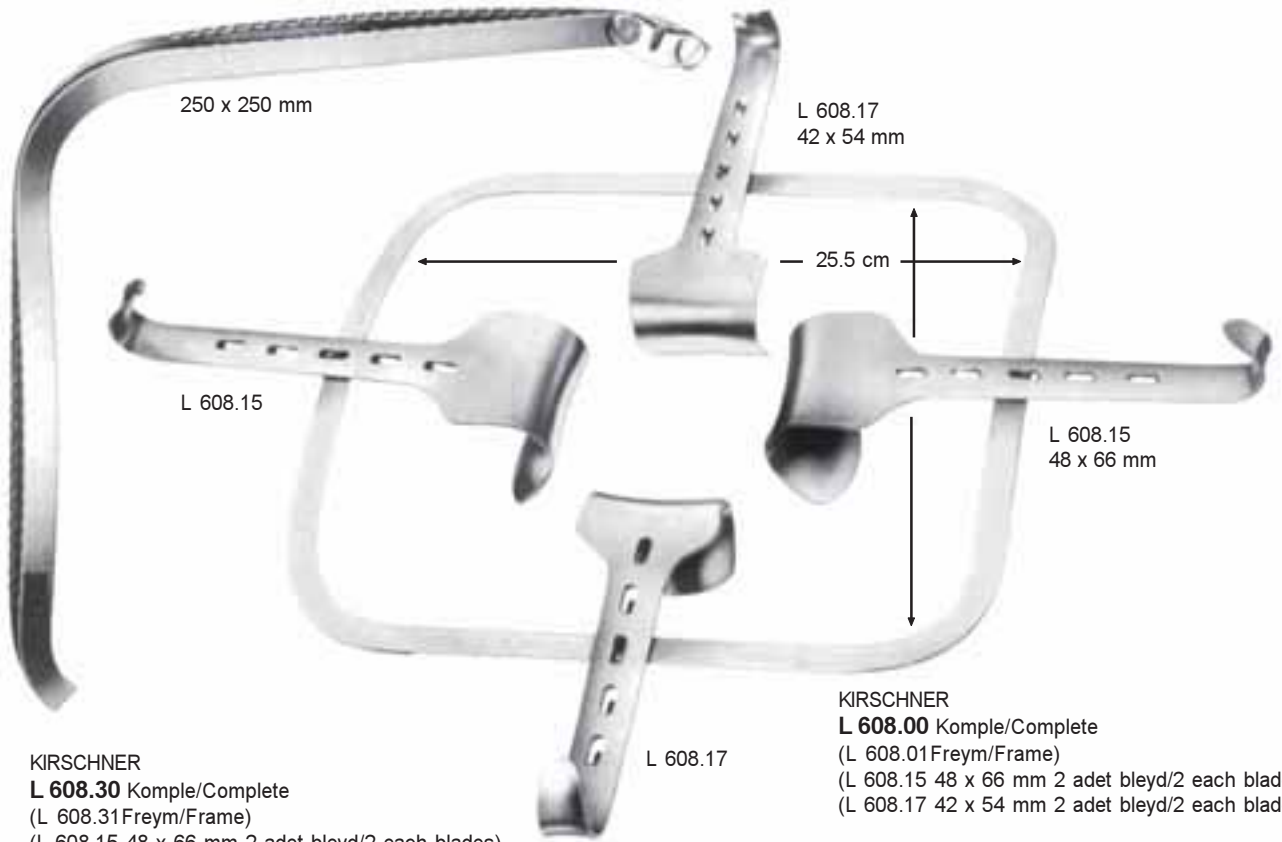

KIRSCHNER
L 608.30 Komple/Complete
(L 608.31 Freym/Frame)
(L 608.15 48 x 66 mm 2 adet bleyd/2 each blades)
(L 608.17 42 x 54 mm 2 adet bleyd/2 each blades)

KIRSCHNER
L 608.00 Komple/Complete
(L 608.01 Freym/Frame)
(L 608.15 48 x 66 mm 2 adet bleyd/2 each blades)
(L 608.17 42 x 54 mm 2 adet bleyd/2 each blades)

L 608.04 275 x 355 mm freym/frame

L 608.06 295 x 275 mm freym/frame



KIRSCHNER
L 608.50
64 x 80 mm



KIRSCHNER-BALFOUR
L 608.52
80 x 82 mm



KIRSCHNER
L 608.54 90 x 69 mm
L 608.56 92 x 95 mm
L 608.58 78 x 58 mm



KIRSCHNER
L 608.64 108 x 42 mm
L 608.66 91 x 55 mm
L 608.68 121 x 55 mm



FRANZ

L 610.00 Komple/Complete

- L 610.05 1 adet freym/1 each frame
- L 610.20 2 adet bleyd/2 each blades
- L 610.30 2 adet bleyd/2 each blades

L 610.02 Komple/Complete

- L 610.05 1 adet freym/1 each frame
- L 610.20 2 adet bleyd/2 each blades
- L 610.30 2 adet bleyd/2 each blades
- L 610.25 2 adet bleyd/2 each blades
- L 610.35 2 adet bleyd/2 each blades

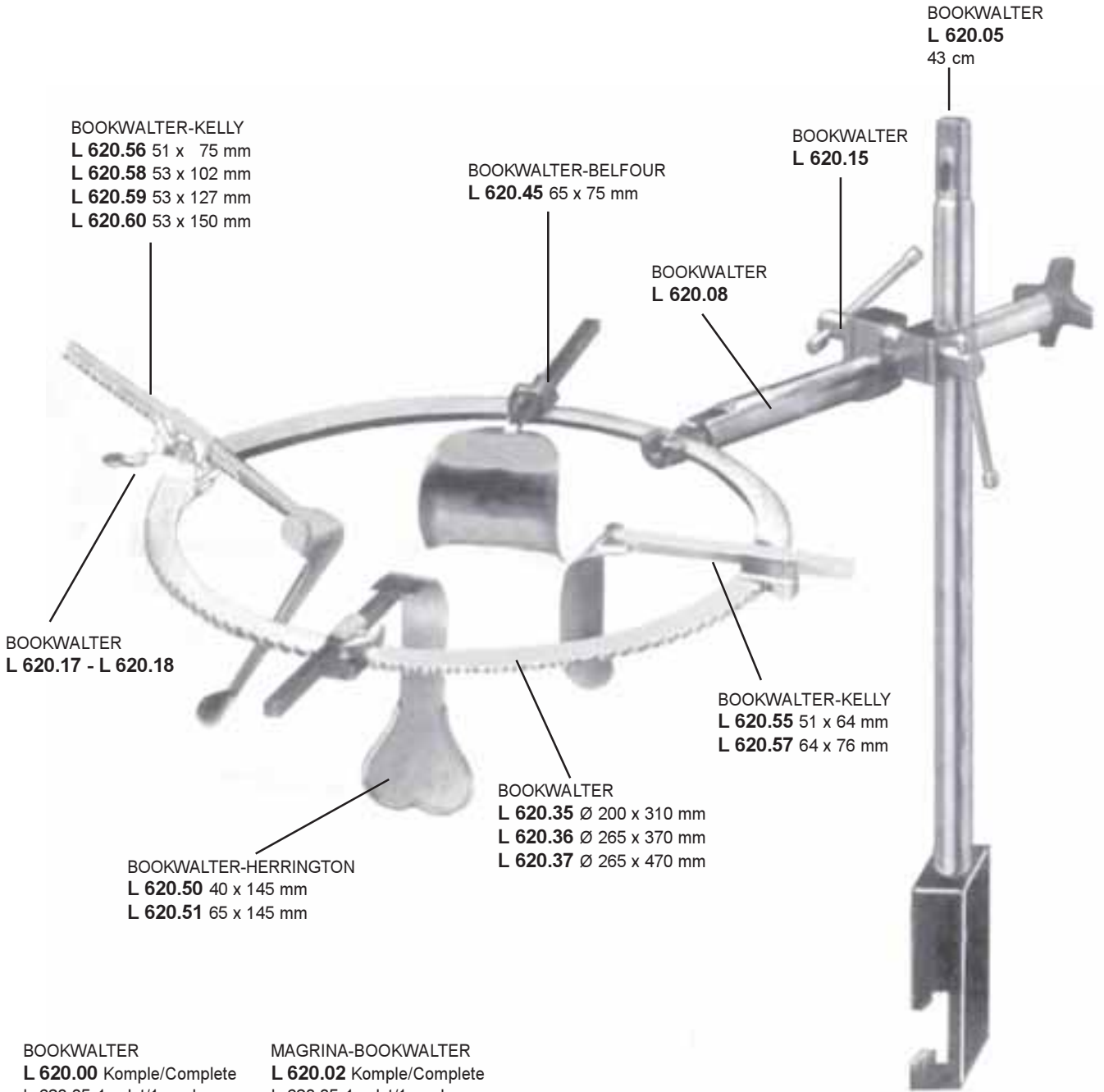

- BOOKWALTER**
L 620.00 Komple/Complete
L 620.05 1 adet/1 each
L 620.08 1 adet/1 each
L 620.15 1 adet/1 each
L 620.17 2 adet/2 each
L 620.18 2 adet/2 each
L 620.35 1 adet/1 each
L 620.36 1 adet/1 each
L 620.37 1 adet/1 each
L 620.45 1 adet/1 each
L 620.50 1 adet/1 each
L 620.51 1 adet/1 each
L 620.55 1 adet/1 each
L 620.56 1 adet/1 each
L 620.57 1 adet/1 each
L 620.58 1 adet/1 each
L 620.59 1 adet/1 each
L 620.60 1 adet/1 each

- MAGRINA-BOOKWALTER**
L 620.02 Komple/Complete
L 620.05 1 adet/1 each
L 620.10 1 adet/1 each
L 620.15 1 adet/1 each
L 620.18 4 adet/4 each
L 620.30 1 adet/1 each
L 620.47 1 adet/1 each
L 620.48 1 adet/1 each
L 620.62 2 adet/2 each
L 620.64 1 adet/1 each



L 620.05 Table Post, for 25 mm System.
43 cm

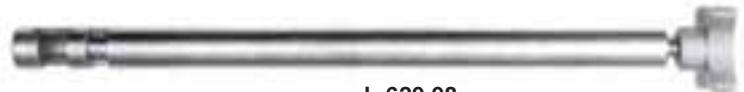

L 620.08
Horizontal Bar
36.5 cm



L 620.10
360° flex bar



L 620.12
30.5 cm



L 620.15
Post Coupling, for
25 mm system



L 620.17
Standard Ratchet



L 620.18
Tilting Ratchet



BOOKWALTER
L 620.30
200 x 265 mm



BOOKWALTER
L 620.31 Ø 215 mm
L 620.32 Ø 265 mm
L 620.33 Ø 315 mm



BOOKWALTER
L 620.35 Ø 200 x 310 mm
L 620.36 Ø 265 x 370 mm
L 620.37 Ø 265 x 470 mm



BOOKWALTER
L 620.40 Ø 215 x 255 mm
L 620.41 Ø 265 x 495 mm
L 620.42 Ø 315 x 495 mm



BOOKWALTER-BELFOUR
L 620.45
 65 x 75 mm



MAGRINA-BOOKWALTER
L 620.47 25 x 90 mm
L 620.48 25 x 130 mm



BOOKWALTER-HARRINGTON
L 620.50 40 x 145 mm
L 620.51 65 x 145 mm



BOOKWALTER-KELLY
L 620.56 51 x 75 mm
L 620.58 53 x 102 mm
L 620.59 53 x 127 mm
L 620.60 53 x 150 mm



BOOKWALTER-KELLY
L 620.55 51 x 64 mm
L 620.57 64 x 76 mm



MAGRINA-BOOKWALTER
L 620.62
 25 x 75 mm



BOOKWALTER
L 620.64
 25 x 115 mm



BOOKWALTER-MEYERDING
L 620.70 17 x 60 mm
L 620.71 25 x 85 mm
L 620.72 50 x 95 mm



SCOVILLE-BOOKWALTER
L 620.80



SCOVILLE-BOOKWALTER
L 620.81



BOOKWALTER
L 620.75
Skin Rake Retractor
17 x 20 mm



BOOKWALTER
L 620.76
Skin Rake Retractor
20 x 8.5 mm



BOOKWALTER
L 620.77
Skin Rake Retractor
25 x 8.5 mm



1/2
COLLIN
L 752.01
95/85 x 18 mm



1/2
COLLIN
L 754.01 100/ 90 mm 28 mm
L 754.02 100/ 90 mm 32 mm
L 754.03 105/ 95 mm 35 mm
L 754.04 115/105 mm 40 mm
Tam boy/Çalışma boyu En
Total lenght/Working lenght Width



1/2
CUSCO
L 760.01
75 x 17 mm



1/2
CUSCO
L 770.01
75 x 17 mm



CUSCO
STANDART
L 762.01 80 x 24 mm
L 762.02 80 x 32 mm
L 762.03 90 x 36 mm
L 762.04 110 x 37 mm



İsviçre örneği
Özellikleri : Uzun ve dar
Swiss patterns
Fatures : Long and narrow

CUSCO
L 763.01 92 x 23-25 mm
L 763.02 100 x 25-27 mm
L 763.03 110 x 27-30 mm



CUSCO
L 771.01 80 x 24 mm
L 771.02 80 x 32 mm
L 771.03 90 x 36 mm
L 771.04 110 x 37 mm



Yassı (Ördek gagası)
Flat (Duck beak)

CUSCO
L 765.01 80 x 32 mm
L 765.02 90 x 37 mm
L 765.04 115 x 37 mm

Parmak baskısıyla açılıp kapanan çift raşetli
With double ratchet, closing and opening of
ratchet by pressure of thumb



SEMM
L 780.01
90 x 14-18 mm
18 cm

1/2

Parmak baskısıyla açılıp kapanan çift raşetli
With double ratchet, closing and opening of
ratchet by pressure of thumb



SEMM
L 781.01 100 x 17-20 mm
L 781.05 100 x 25-30 mm
18.5 cm

1/2



SEYFFERT
L 782.01 100 x 17 mm
L 782.05 100 x 33 mm
23 cm

1/2

Alet ve kataterleri çıkarmak için bir tarafı açık
One side open for faking up instruments and
catheters



SEYFFERT
L 783.01 110 x 33 mm
23 cm

1/2



COLLIN
L 750.01 53 x 10 mm
Çocuklar için/For children



TRELAT
L 785.01 85 x 33 mm
L 785.02 95 x 35 mm
L 785.03 115 x 43 mm



GRAVE
L 790.01 75 x 20 mm
L 790.02 95 x 30 mm
L 790.03 105 x 33 mm



PEDERSON
L 791.01 100 x 22 mm
L 791.02 120 x 25 mm



SEIDL
K 804.01 80 x 8 mm
K 804.02 80 x 10 mm
K 804.03 90 x 14 mm
 17 cm



KRISTELLER
K 806.01 70 x 15 mm
 17 cm

1/2



KRISTELLER
K 807.01 70 x 27 mm
K 807.02 75 x 30 mm
K 807.03 90 x 36 mm
 17.5 cm

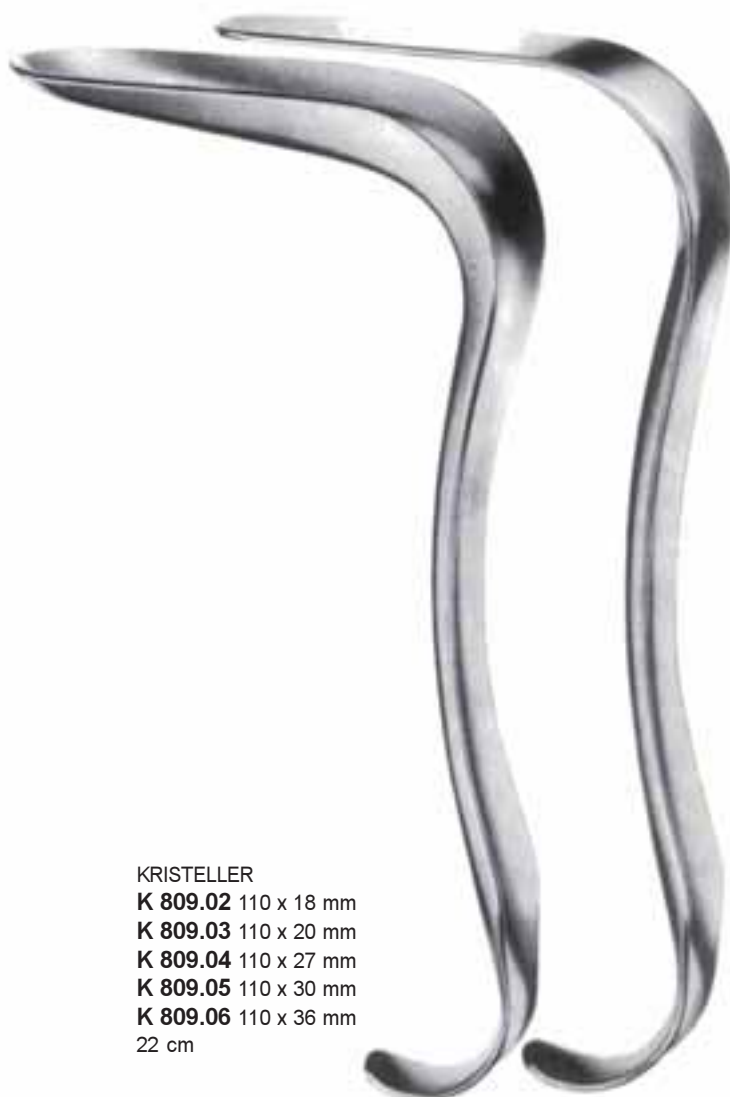

KRISTELLER
K 809.02 110 x 18 mm
K 809.03 110 x 20 mm
K 809.04 110 x 27 mm
K 809.05 110 x 30 mm
K 809.06 110 x 36 mm
 22 cm



KRISTELLER
K 812.00 - K 812.03
Alt bleyd/Lower blade



KRISTELLER
K 814.00 - K 814.03
Üst bleyd/Upper blade

K 812.00
70 x 15 mm
17.5 cm



K 814.00
75 x 10 mm
17.5 cm



K 812.01
70 x 27 mm
18 cm



K 814.01
75 x 23 mm
18 cm



K 812.02
75 x 30 mm
18 cm



K 814.02
80 x 25 mm
18 cm



K 812.03
90 x 36 mm
18.5 cm



K 814.03
100 x 32 mm
18.5 cm



1/2

1/2



KRISTELLER
K 812.04 - K 812.08
Alt bleyd/Lower blade



KRISTELLER
K 814.04 - K 814.08
Üst bleyd/Upper blade

K 812.04
110 x 18 mm
21.5 cm



K 814.04
115 x 14 mm
21.5 cm



K 812.05
110 x 27 mm
21.5 cm



K 814.05
115 x 23 mm
21.5 cm



K 812.06
110 x 20 mm
22 cm



K 814.06
115 x 16 mm
22 cm



K 812.07
110 x 30 mm
22 cm



K 814.07
115 x 26 mm
22 cm



K 812.08
110 x 36 mm
22.5 cm



K 814.08
120 x 30 mm
22.5 cm



1/2

1/2



KRISTELLER
WIENER-VIENNA PATTERN
Set/Set
K 841.00 110 x 20 mm
K 841.01 110 x 30 mm
K 841.02 110 x 36 mm

K 841.03
110 x 20 mm



K 841.04
110 x 30 mm



K 841.05
110 x 36 mm



K 841.06
115 x 18 mm



K 841.07
115 x 26 mm



K 841.08
115 x 32 mm



K 841.03 - K 841.05
Alt bleyd/Lower blade
21.5 cm

K 841.06 - K 841.08
Üst bleyd/Upper blade
22 cm



Hafif bombeli
Slightly concave

KRISTELLER
K 817.02 - K 817.04
20.5 cm

1/2



Hafif bombeli
Slightly concave

JACKSON
K 819.02 - K 819.04
17.5 cm

1/2

K 817.02
80 x 28 mm



K 819.02
76 x 38 mm



K 817.03
80 x 35 mm



K 819.03
89 x 38 mm



K 817.04
85 x 40 mm



K 819.04
102 x 38 mm



1/2

1/2



KALLMORGEN
K 813.01
75 x 39 mm
17 cm

1/2



KALLMORGEN
K 825.01 Set/Set
75 x 39 mm
17 cm

1/2



KALLMORGEN
K 826.01 Set/Set
95 x 39 mm
20 cm

1/2



BREISKY
K 830.01 72 x 25 mm / 77 x 30 mm
14 cm
K 830.05 75 x 30 mm / 92 x 38 mm
17 cm



SIMS
K 832.01 70 x 26 mm / 75 x 30 mm
12.5 cm
K 832.05 75 x 30 mm / 80 x 35 mm
15 cm
K 832.08 80 x 36 mm / 90 x 40 mm
17.5 cm



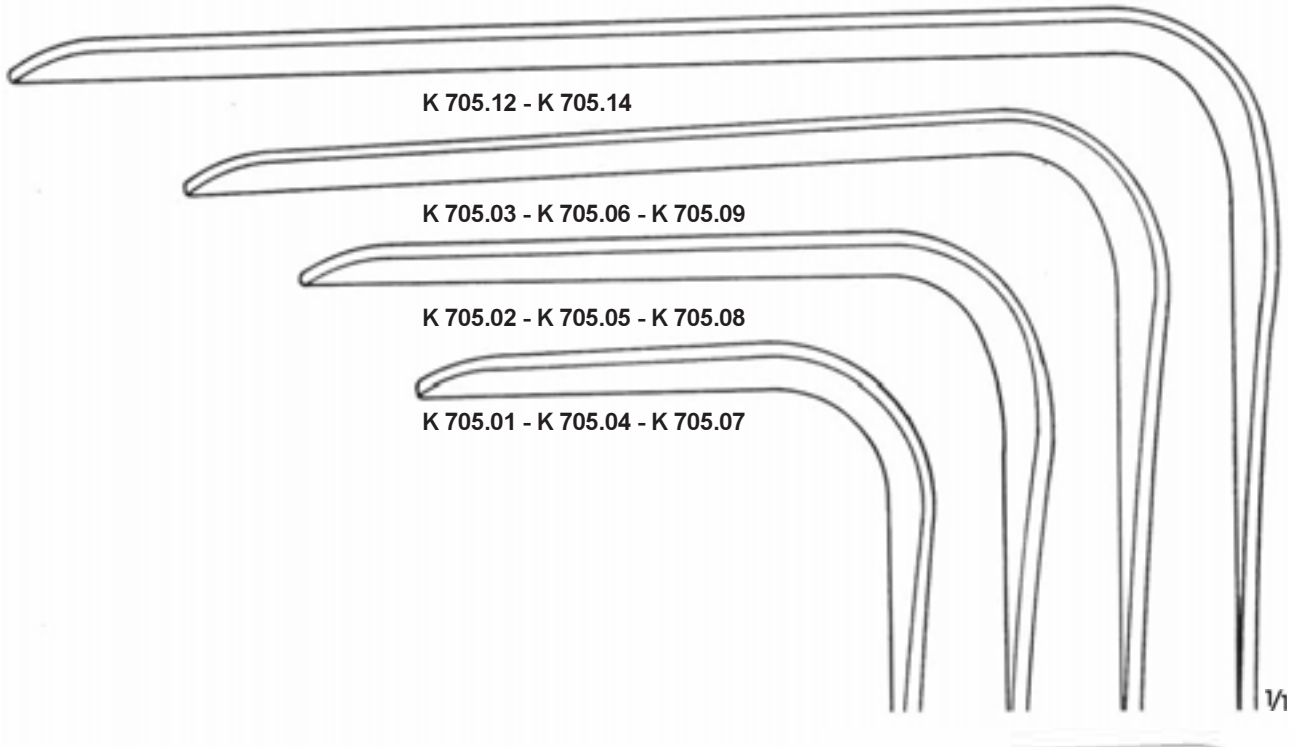

Ağız uzunlukları Length of blades	Ağız genişlikleri Width of blades		
	35 mm	45 mm	60 mm
62 mm	K 705.01	K 705.04	K 705.07
92 mm	K 705.02	K 705.05	K 705.08
122 mm	K 705.03	K 705.06	K 705.09
160 mm		K 705.12	K 705.14



K 706.03
112 x 45 mm



K 706.02
90 x 45 mm



K 706.01
60 x 45 mm



DOYEN
K 706.01 - K 706.03
23.5 cm



LANDAU
K 680.02 100 x 28 mm
K 680.04 110 x 38 mm
29 cm

1/2



BREISKY
WIENER-VIENNA PATTERN
K 682.02 100 x 20 mm
K 682.03 100 x 25 mm
K 682.04 100 x 30 mm
K 682.05 100 x 35 mm
K 682.06 100 x 40 mm
30 cm

1/2



BREISKY
WIENER-VIENNA PATTERN
K 683.02 130 x 20 mm
K 683.03 130 x 25 mm
K 683.04 130 x 30 mm
K 683.05 130 x 35 mm
K 683.06 130 x 40 mm
32 cm

1/2



BREISKY
WIENER-VIENNA PATTERN
K 684.02 160 x 40 mm
K 684.03 180 x 40 mm
35 cm

1/2



SIMON
K 614.02
115 x 26 mm
27.5 cm

SIMON
K 614.01
115 x 22 mm
27.5 cm

K 612.01
105 x 27 mm
25 cm

TÜBINGER
K 610.01
95 x 20 mm
26.5 cm

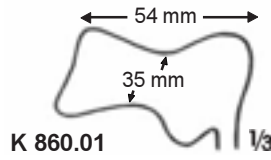
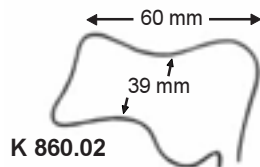
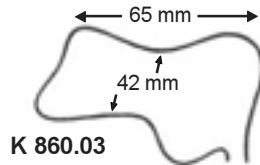
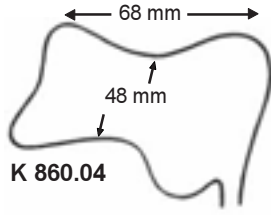

K 860.01 - K 860.04
Ağırlık asmak için kancalı saplı
With hook-shaped handle for
hanging-in weights
27 cm



AUWARD
K 862.01
65 x 38-28 mm
1.530 gr.
Sabit ağırlık
Fixed weight
23 cm



K 868.03
Sökülebilir süzgeçli
Removable strainer only

WEISSBARTH
K 868.01 80 x 28 mm
K 868.02 85 x 42 mm
21 cm



AUWARD
K 863.01 75 x 42-40 mm
K 863.02 105 x 43-40 mm
1.470 gr. Sökülebilir ağırlıklı
With detachable weight
23 cm

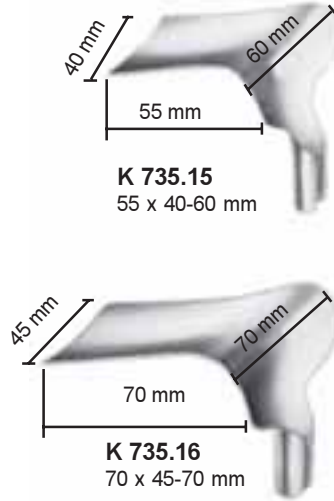
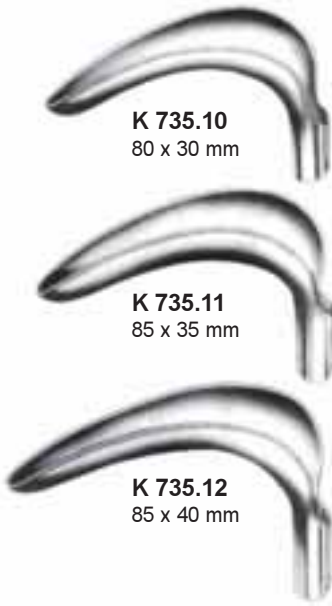

(K 735.10 - K 735.16 ve K 735.20 K 735.27) birbirleriyle deđiřtirilebilir.
(K 735.08 ve K 735.09) saplarına olduđu gibi (K 735.01)'yada uyar.
The mentioned blades (K 735.10 - K 735.16 and K 735.20 - K 735.27)
can be exchanged. They fit handle K 735.01 as well as handles
K 735.08 and K 735.09.

SCHERBACK
T 791.00 Komple/Complete
(K 735.01) Sap/Handle
(T 790.00) Ađırlık/Weight
(K 735.10 - K 735.15) 4 Bleyd/4 Blades



BOZEMANN
K 735.30 Set/Set
(K 735.08 - K 735.09) 2 Sap/2 Handles
(K 735.20 - K 735.27) 8 Bleyd/8 Blades



GELPI
L 408.00
13.5 cm



GELPI
L 409.00
17.5 cm



RICHTER
L 412.00
17 cm

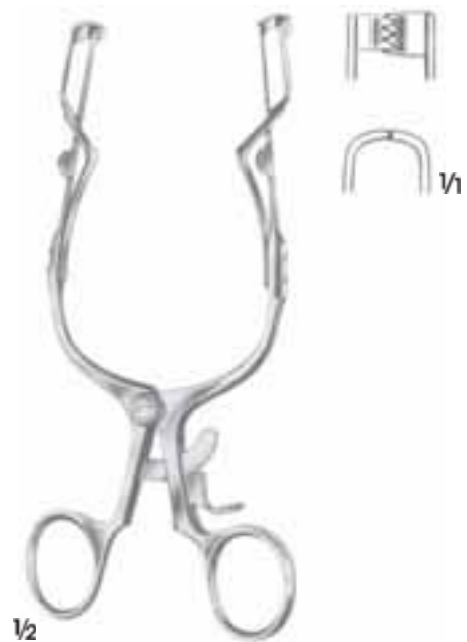

RICHTER-STILLE
L 413.01
18 cm



1/2

JOLL (FRIEDMANN)
L 417.00
15.5 cm



O'SULLIVAN - O'CONNOR
L 418.00 Komple/Complete
L 418.01
L 418.03 - L 418.04 - L 418.05

L 418.01
Freym/Frame
2 adet deęiřtirilebilir yan bleyd 10 x 45 mm ve
kitlenebilir sabitleyici maksimum açıklığı 40 mm
With 2 interchangeable lateral blades 10 x 45 mm and
locktite catch, maximum spread 40 mm



L 418.03
45 x 17 mm

L 418.04
85 x 40 mm

L 418.05
90 x 45 mm



HEGAR
J 750.00 - J 751.17
18.5 cm

J 750.01	1 mm	J 750.14	14 mm
J 750.02	2 mm	J 750.15	15 mm
J 750.03	3 mm	J 750.16	16 mm
J 750.04	4 mm	J 750.17	17 mm
J 750.05	5 mm	J 750.18	18 mm
J 750.06	6 mm	J 750.19	19 mm
J 750.07	7 mm	J 750.20	20 mm
J 750.08	8 mm	J 750.21	21 mm
J 750.09	9 mm	J 750.22	22 mm
J 750.10	10 mm	J 750.23	23 mm
J 750.11	11 mm	J 750.24	24 mm
J 750.12	12 mm	J 750.25	25 mm
J 750.13	13 mm	J 750.26	26 mm

J 751.01	1.5 mm	J 751.14	14.5 mm
J 751.02	2.5 mm	J 751.15	15.5 mm
J 751.03	3.5 mm	J 751.16	16.5 mm
J 751.04	4.5 mm	J 751.17	17.5 mm
J 751.05	5.5 mm		
J 751.06	6.5 mm		
J 751.07	7.5 mm		
J 751.08	8.5 mm		
J 751.09	9.5 mm		
J 751.10	10.5 mm		
J 751.11	11.5 mm		
J 751.12	12.5 mm		
J 751.13	13.5 mm		



J 790.00

Set (J 750.04 - J 750.17) 14 parça
Set (J 750.04 - J 750.17) 14 piece
Y 310.10 Y 390.05 dahil
With Y 310.10 - Y 390.05

J 790.01

Set (J 751.04 - J 751.17) 14 parça
Set (J 751.04 - J 751.17) 14 piece
Y 310.10 Y 390.05 dahil
With Y 310.10 - Y 390.05



J 792.00

Tam set 28 parça/Full set 28 piece
Set (J 750.04 - J 750.17) + (J 751.04 - J 751.17)
Y 110.10 Y 191.05 dahil
With Y 110.10 - Y 191.05

Konteyner/Container



- Y 310.10 285 x 280 x 100 mm
- Y 310.13 285 x 280 x 135 mm
- Y 310.15 285 x 280 x 150 mm
- Y 310.20 285 x 280 x 200 mm
- Y 310.26 285 x 280 x 260 mm

Konteyner/Container



- Y 110.10 580 x 280 x 100 mm
- Y 110.13 580 x 280 x 135 mm
- Y 110.15 580 x 280 x 150 mm
- Y 110.20 580 x 280 x 200 mm
- Y 110.26 580 x 280 x 260 mm

Tel sepetler/Wire baskets



- Y 390.03 255 x 245 x 30 mm
- Y 390.05 255 x 245 x 50 mm
- Y 390.07 255 x 245 x 70 mm
- Y 390.10 255 x 245 x 100 mm

Tel sepetler/Wire baskets



- Y 191.03 540 x 255 x 30 mm
- Y 191.05 540 x 255 x 50 mm
- Y 191.07 540 x 255 x 70 mm
- Y 191.10 540 x 255 x 100 mm

Tel taban/Wire Base



- Y 393.00 258 x 258 x 30 mm

Tel taban/Wire Base



- Y 193.00 545 x 255 x 30 mm

Y 840.00

Bölücü, Y 841.00 için
Divider, to be used with Y 841.00



Y 841.00

Vidalı bölücü ray
Sliding rails with securing screws



Y 842.00

Vidalı bölücü bar
Limiting



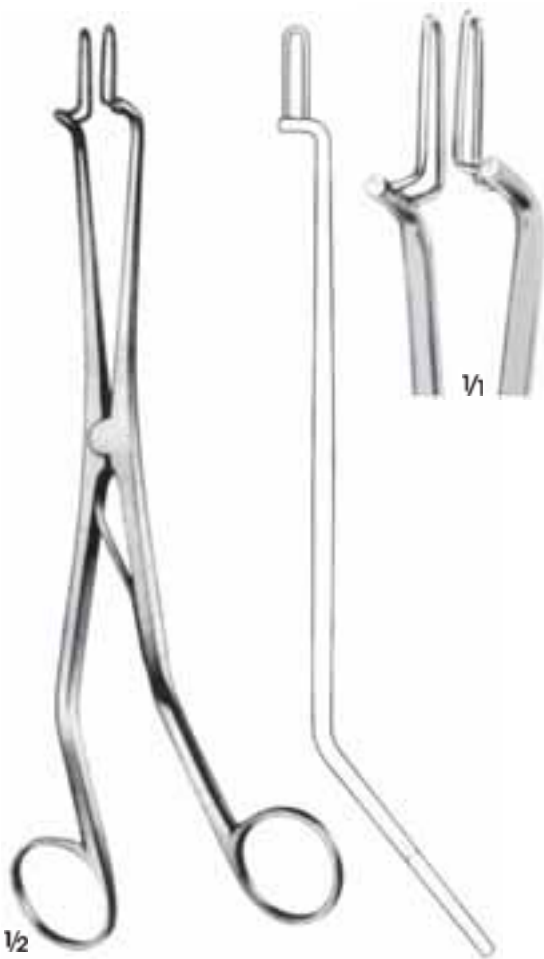

KOGAN
T 400.01
24 cm



KOGAN
T 401.01
24 cm



J 095.06 - J 095.20
16 cm

	Charr.
J 095.06	6
J 095.07	7
J 095.08	8
J 095.09	9
J 095.10	10
J 095.11	11
J 095.12	12
J 095.13	13
J 095.14	14
J 095.15	15
J 095.16	16
J 095.18	18
J 095.20	20

5 mm



1/2

MAYO
J 650.05
Bükülebilir/Malleable
33 cm

4 mm



1/2

SIMS
J 652.05
33 cm
J 652.08
Bükülebilir/Malleable
33 cm

3 mm



1/2

J 653.05
30 cm

4 mm



1/2

SIMPSON
J 656.05
Bükülebilir/Malleable
29 cm

4 mm



1/2

VALLEIX
J 658.05
Bükülebilir/Malleable
25 cm

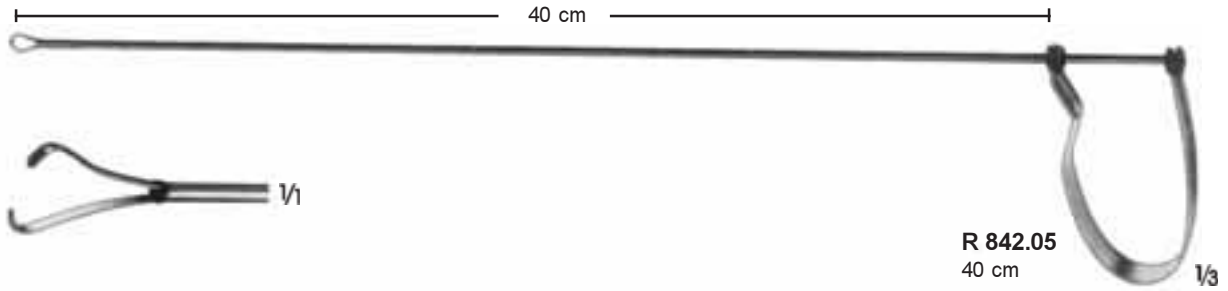

SIMS
K 395.03
26 cm



BRAUN
K 390.03
27 cm



J 063.00
Burmali/Spiral
27 cm



PLAYFAIR
J 068.03
32 cm



AMANN
T 408.01
32 cm



1/2

RAPID
J 346.01 - J 346.03
Eğri/Curves

	Uzunluk/Length	Ø
J 346.01	200 mm	8 mm
J 346.02	250 mm	10 mm
J 346.03	250 mm	12 mm



1/2

RAPID
J 347.01 - J 347.03
Duble eğri/Double Curves

	Uzunluk/Length	Ø
J 347.01	200 mm	8 mm
J 347.02	250 mm	10 mm
J 347.03	250 mm	12 mm



1/2

SIMS
E 391.01 Ø 3.2 mm
27 cm



1/2

SIMS
E 392.01 Ø 3.2 mm
27 cm

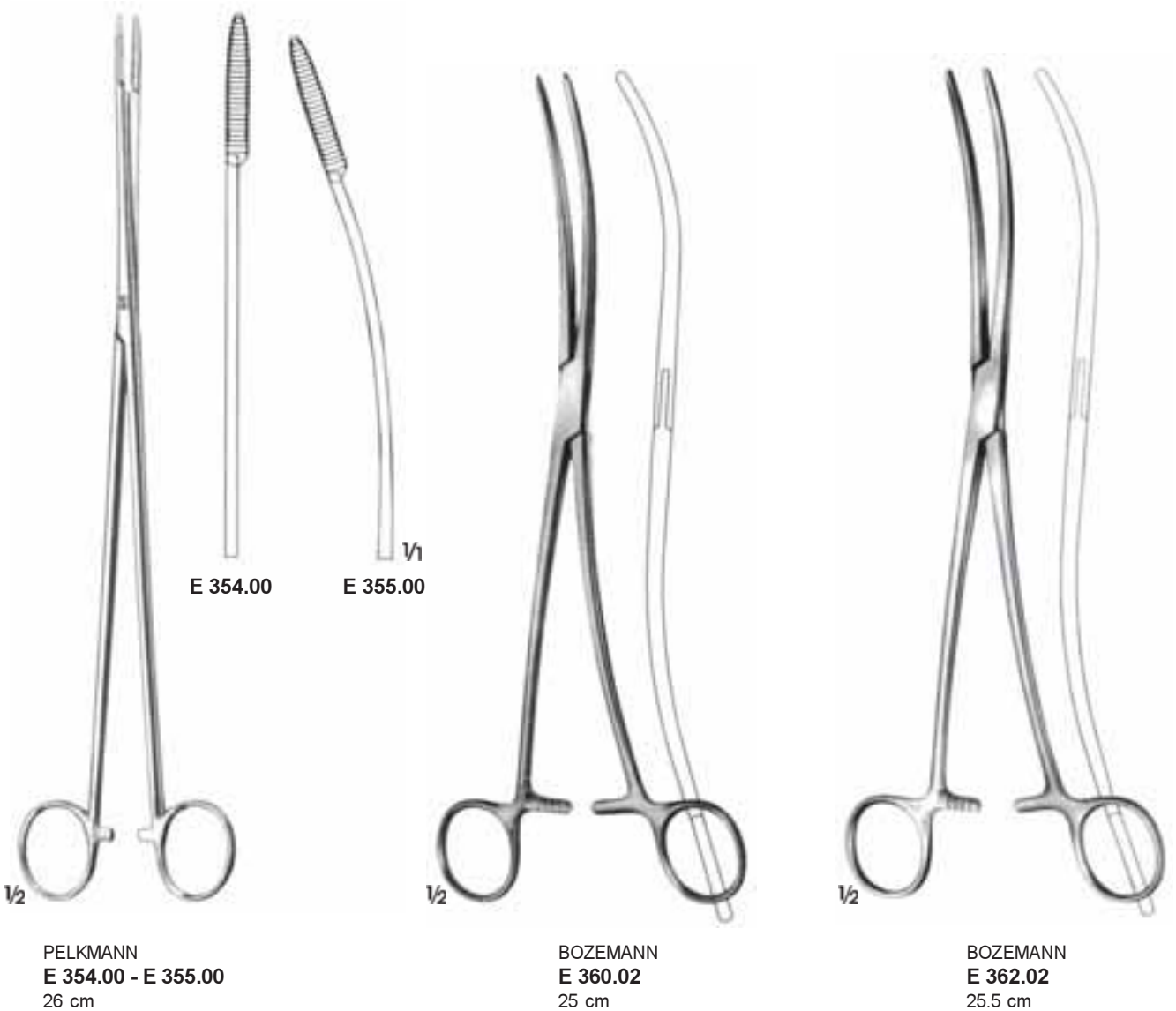



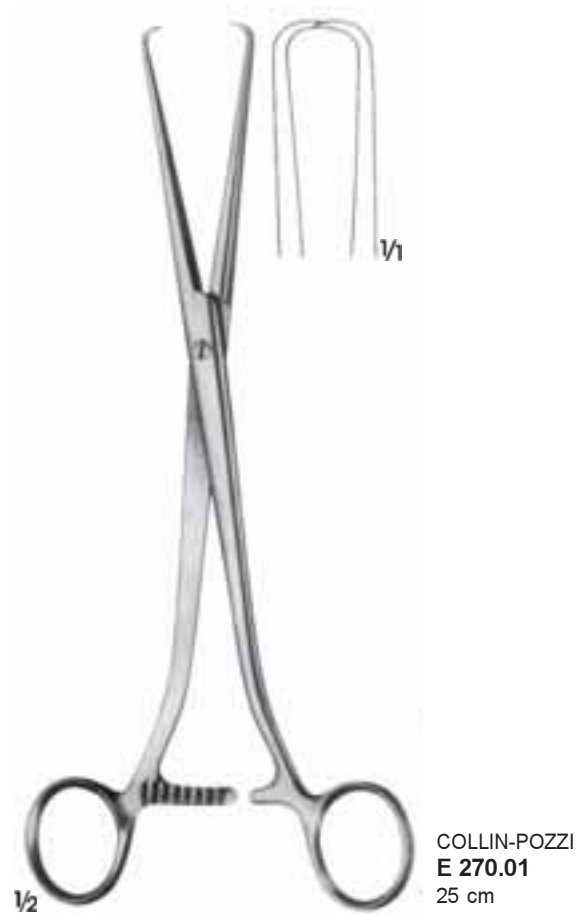
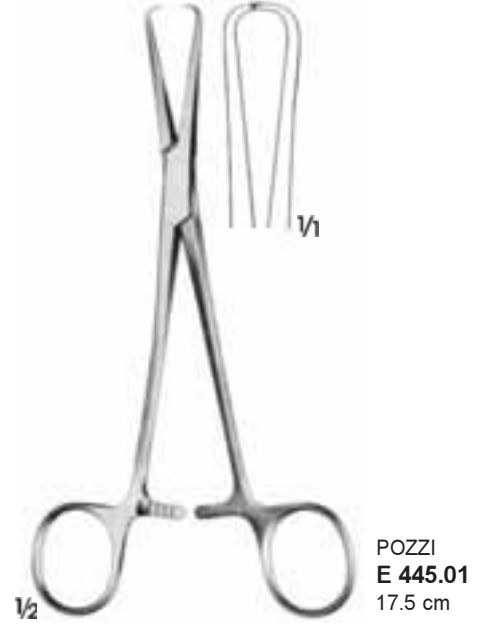
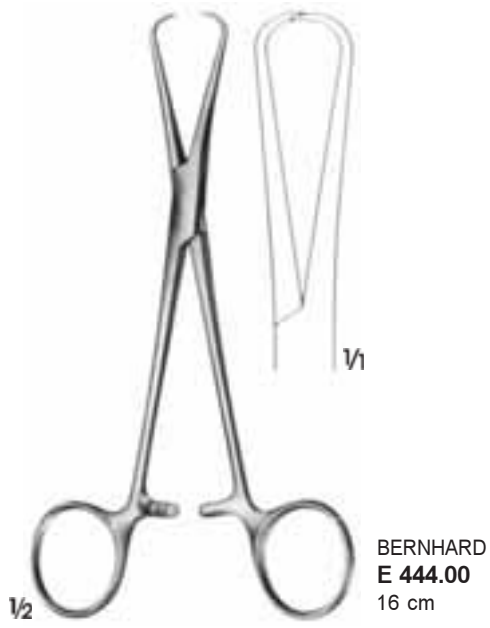

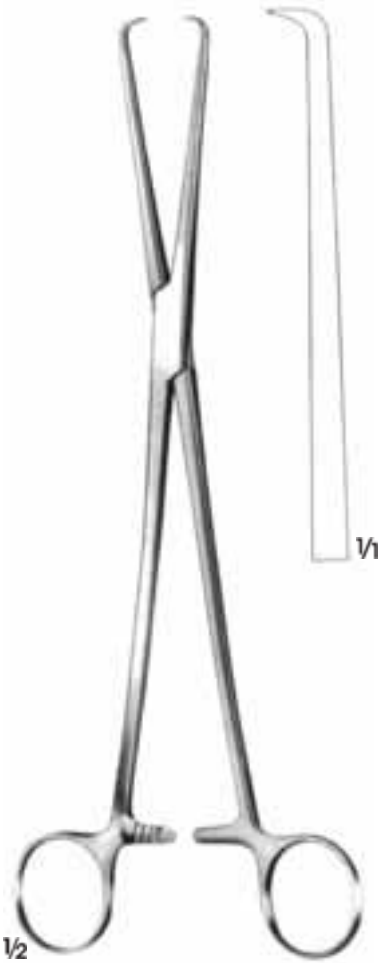

SCHRÖDER
E 251.00
25 cm



SCHRÖDER
E 253.01
25 cm



POZZI
E 255.01
25.5 cm



E 260.01
26.5 cm



ABEL
E 262.01
28 cm

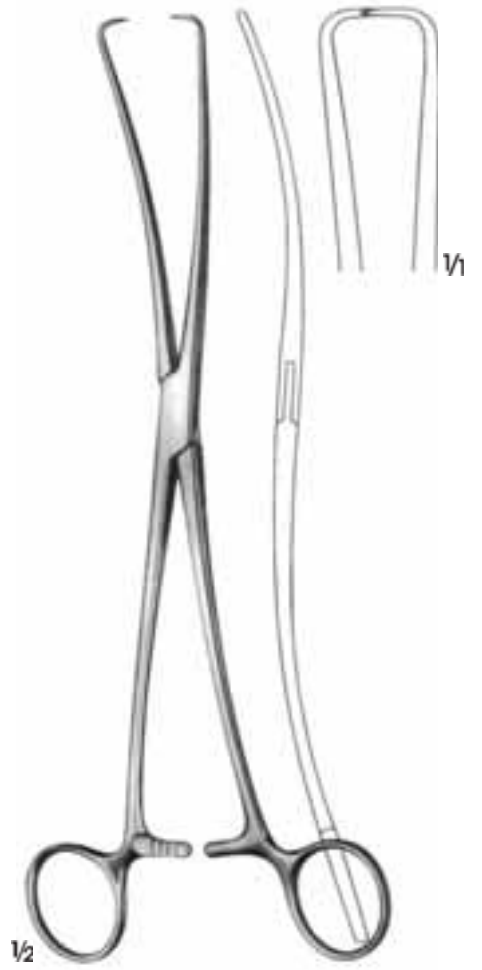

DUBLAY
E 265.01
25 cm



MUSEUX
E 375.01
20 cm



JACOBS
E 376.01
21.5 cm

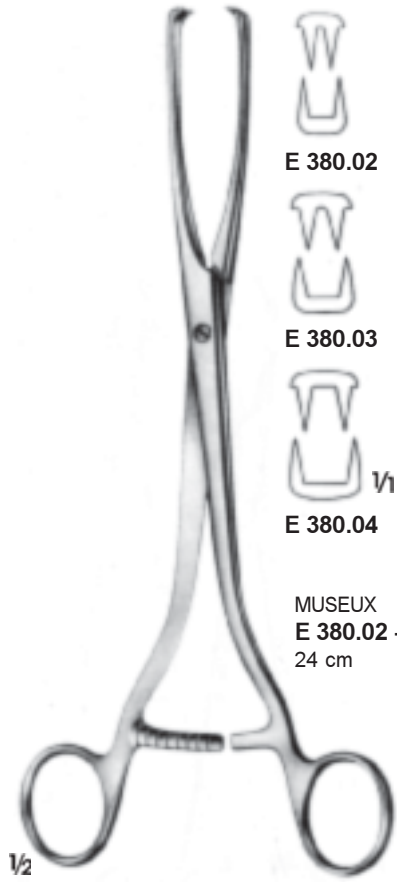

MUSEUX
E 380.02 - E 380.04
24 cm



MUSEUX
E 381.02 - E 381.04
26.5 cm



MUSEUX
E 382.02 - E 382.04
Yana eğri/Sideways curves
24 cm



LITTLEWOOD
E 378.02
18.5 cm



TEALE
E 379.02
22.5 cm



KÜSTNER
E 383.02
25 cm



LAHEY
E 200.00
15.5 cm

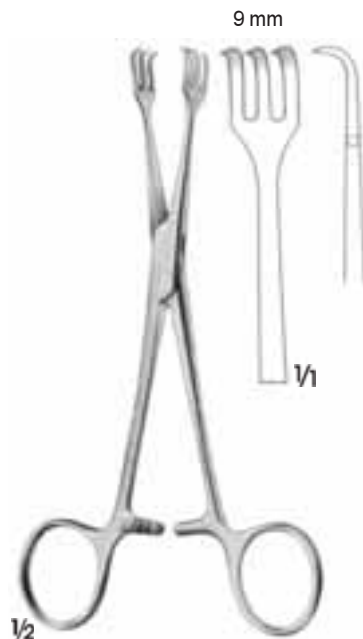

LAHEY
E 201.00
15.5 cm

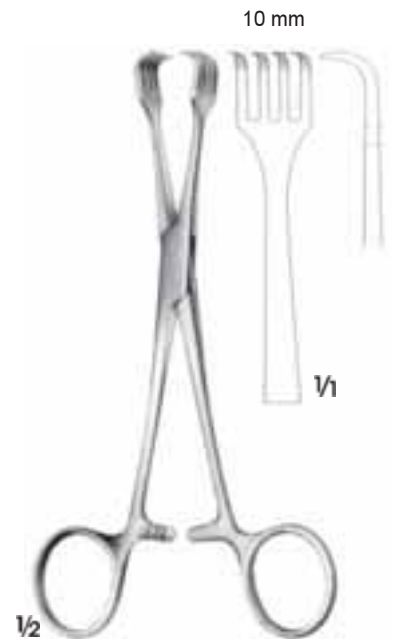

BRUN
E 202.00
15.5 cm

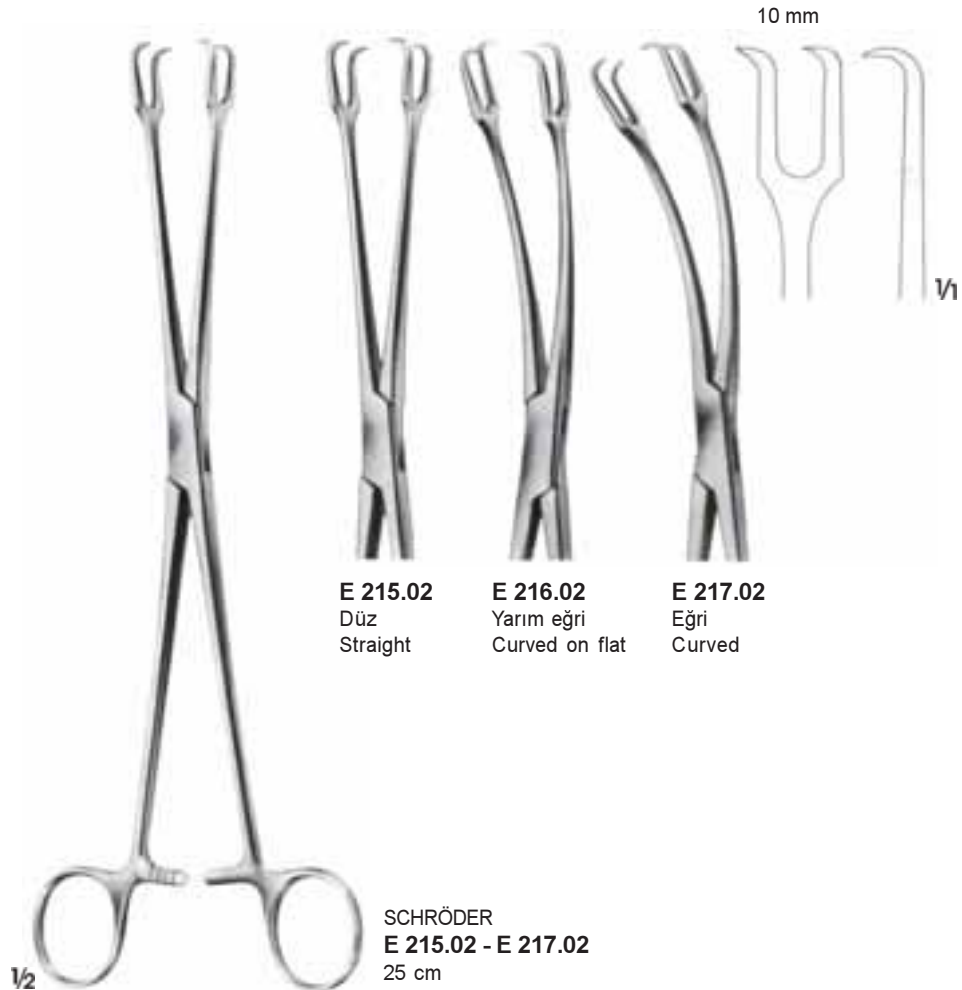
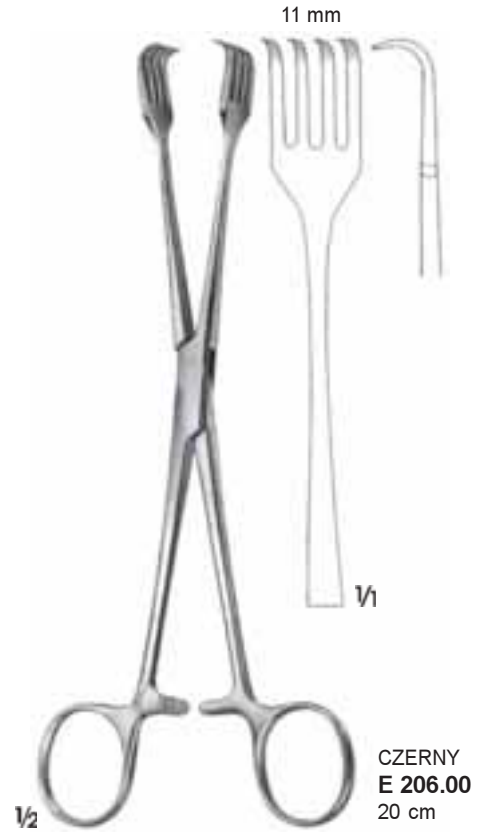
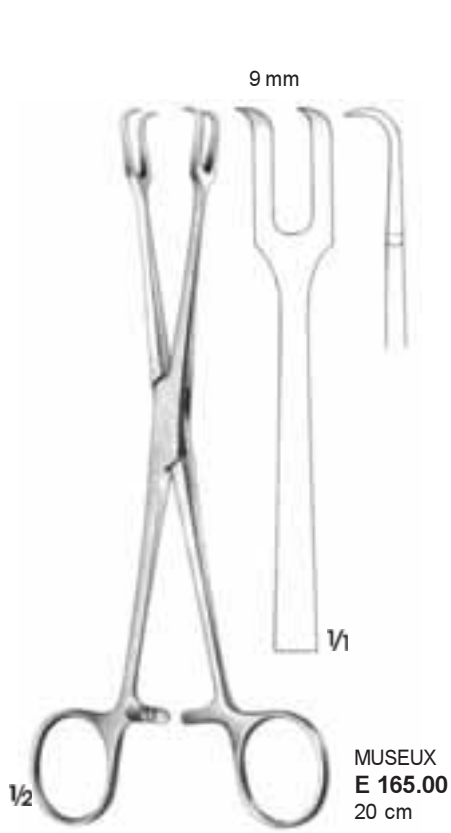

11 mm



18 mm



22 mm



SCHRÖDER
E 208.00
27 cm



E 210.00
26 cm



PRATT
E 211.00
27 cm

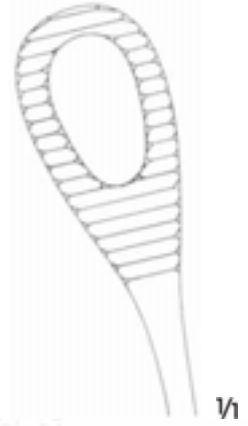

HEYWOOD-SMITH
E 198.00
25 cm



NOTO
E 120.00
28 cm



KELLY
E 122.00
32 cm

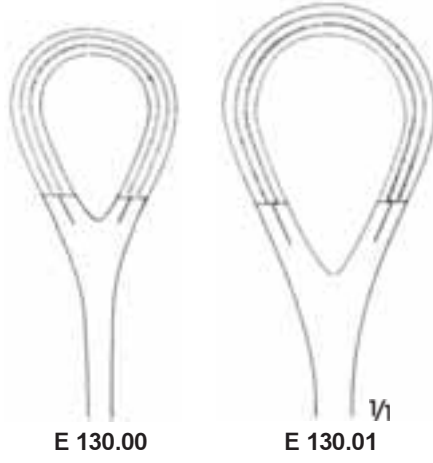

DOYEN
E 196.00
18.5 cm



E 130.00 25 cm
E 130.01 27 cm



BUMM
E 135.01
28 cm

Hareketli çeneli
With movable jaws



COLLIN
E 550.01
26.5 cm

Hareketli çeneli
With movable jaws



E 551.01
26 cm



SOMER
E 560.01
23.5 cm



STRASSMANN
E 561.01
26.5 cm



COLLIN
E 570.01
25 cm



DARTIGUES
E 575.02
25.5 cm



COLLIN
E 577.02
28.5 cm



SEGOND
B 116.00
27 cm



DOYEN
T 420.00
Myoma burgusu
Myoma screw
15 cm



DOYEN
T 421.00
Myoma burgusu
Myoma screw
19 cm



V1

B 034.01
22.5 cm



V1

B 112.00
23 cm



V1

AYRE
B 113.00
23.5 cm



**RANDALL
N 580.02**
Biyopsi küreti
Biopsy curette
24 cm



**NOVAK-SCHOECKAERT
N 581.02**
Biyopsi küreti
Biopsy curette
24 cm



**ASCH
N 585.01**
Kaşık/Scoop
20 cm

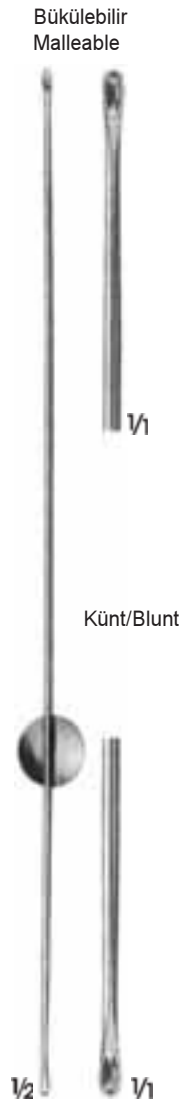

N 588.02
Kaşık/Scoop
27 cm

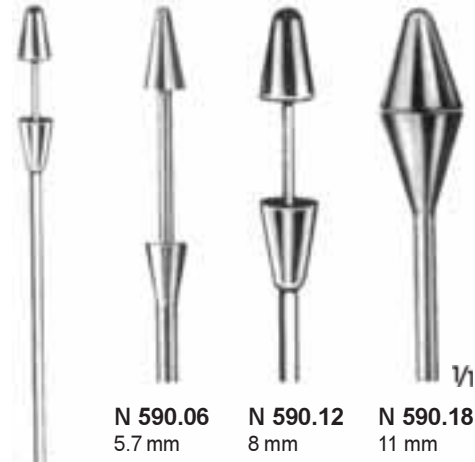

GUSBERG
N 590.06 - N 590.18
Biyopsi küreti
Biopsy curette
24 cm



BERLIN
N 595.04
Biyopsi küreti
Biopsy curette
27 cm



MÜNCHEN
N 595.05 - N 595.06
Biyopsi küreti
Biopsy curette
27 cm

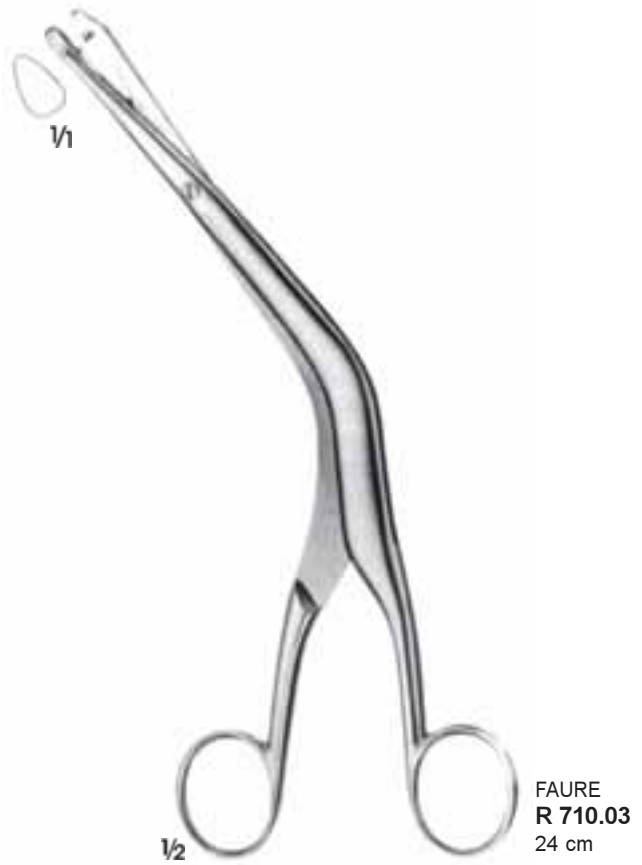
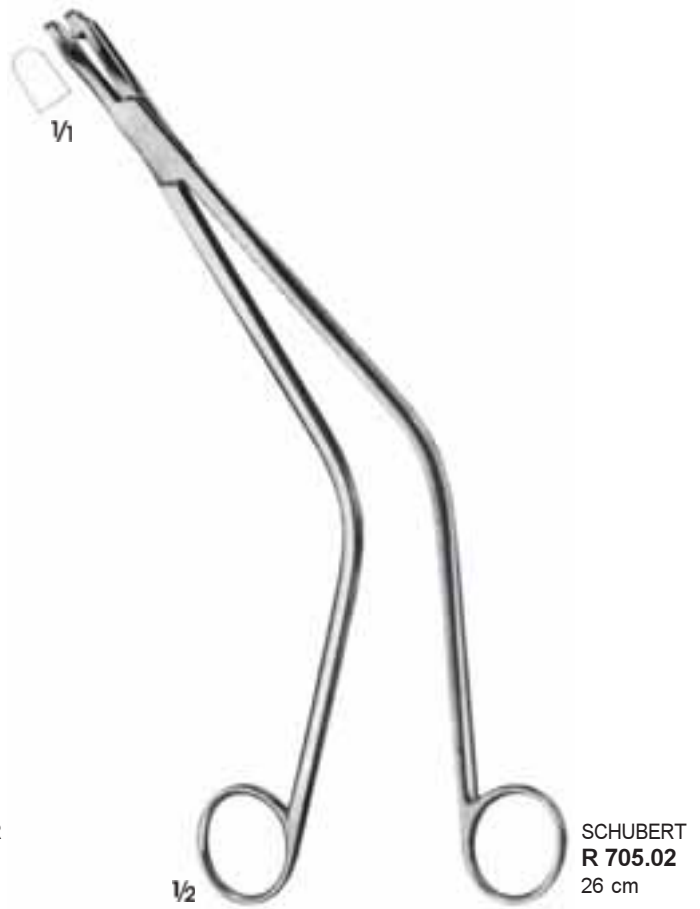

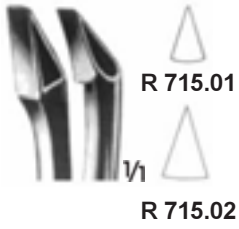
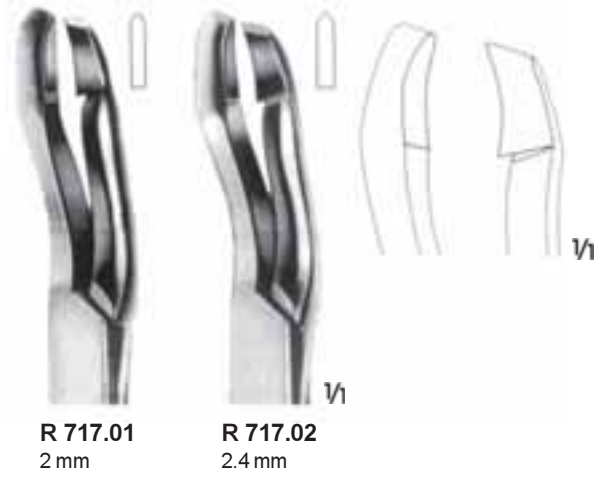

SCHUMACHER
R 715.01 - R 715.02
24 cm



SEIDL DBP
R 717.01 - R 718.01
Bayonet biyopsi pensleri
Bayonet-Shaped biopsy forceps
24 cm

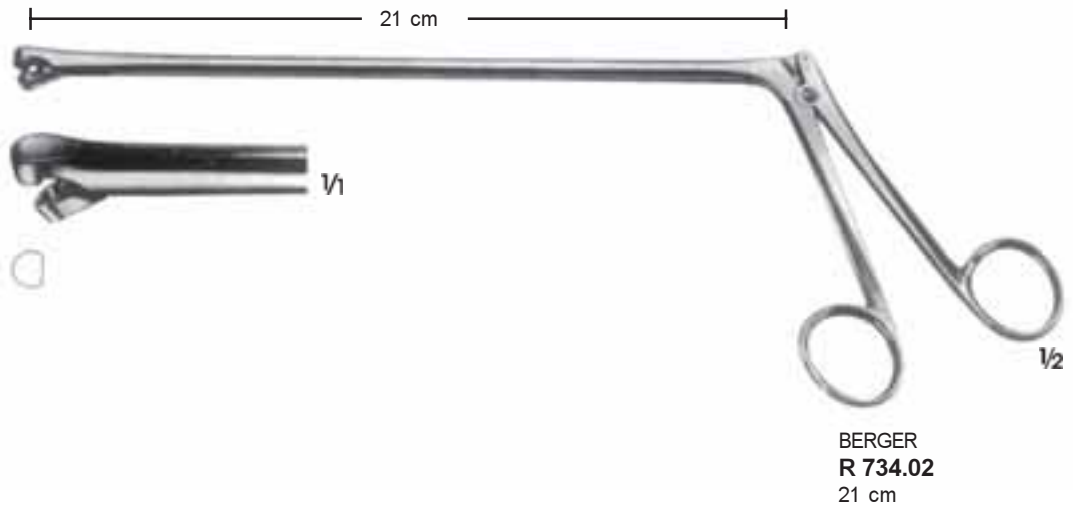
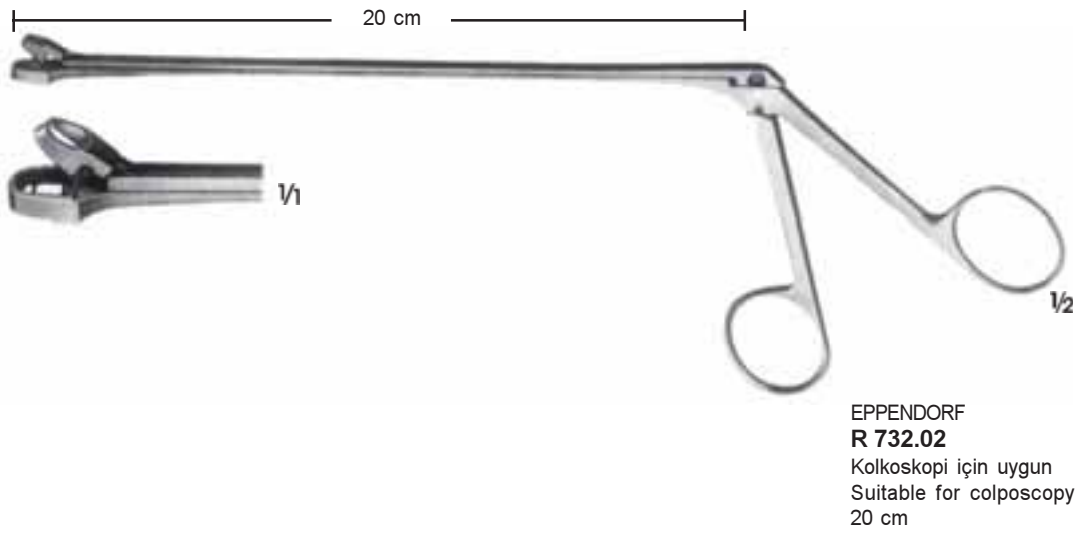

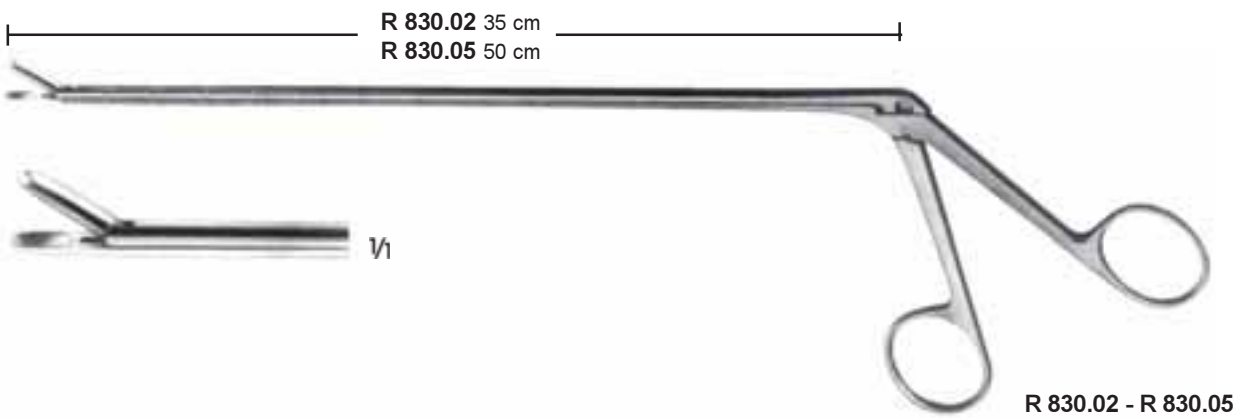
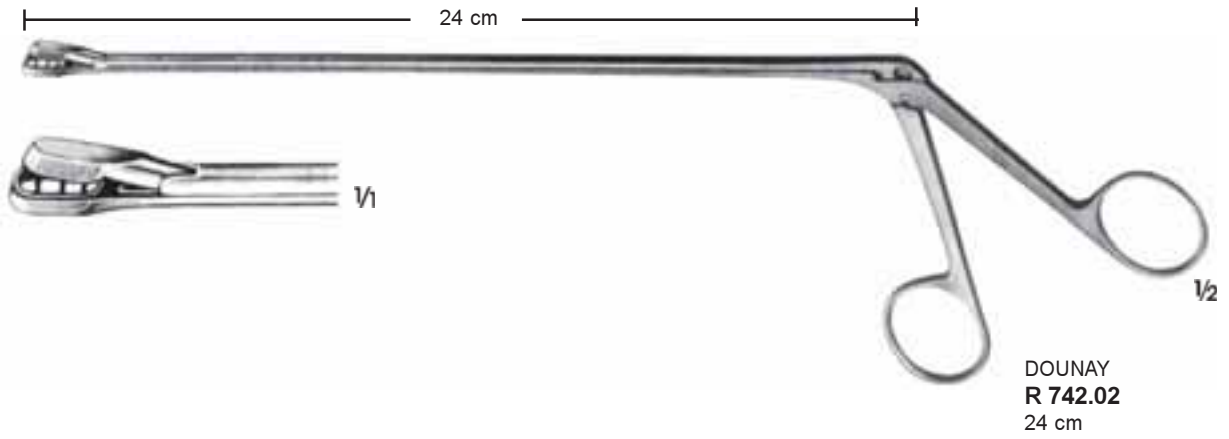
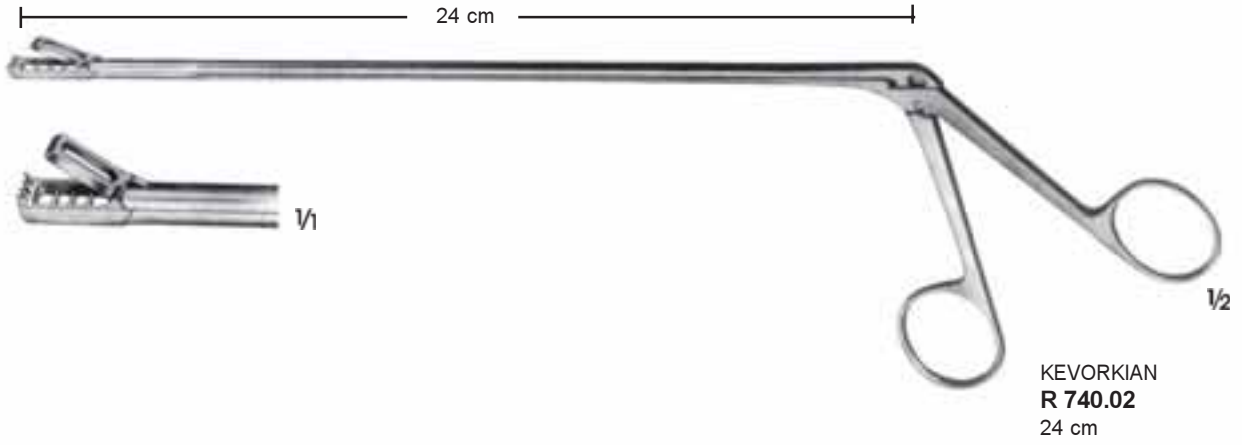

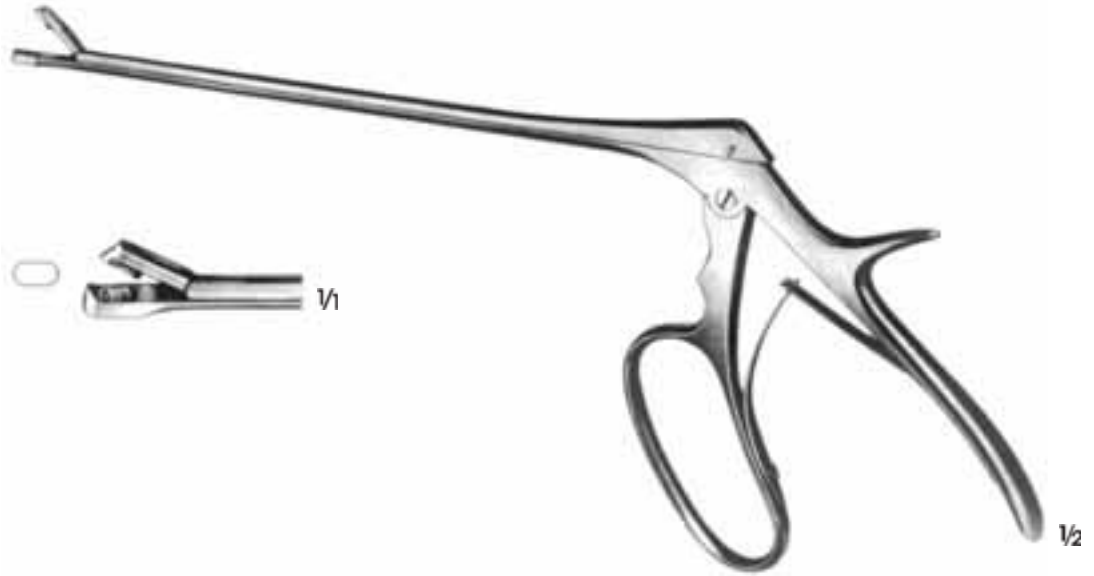

TISCHLER
R 750.01 20 cm
R 750.03 24 cm

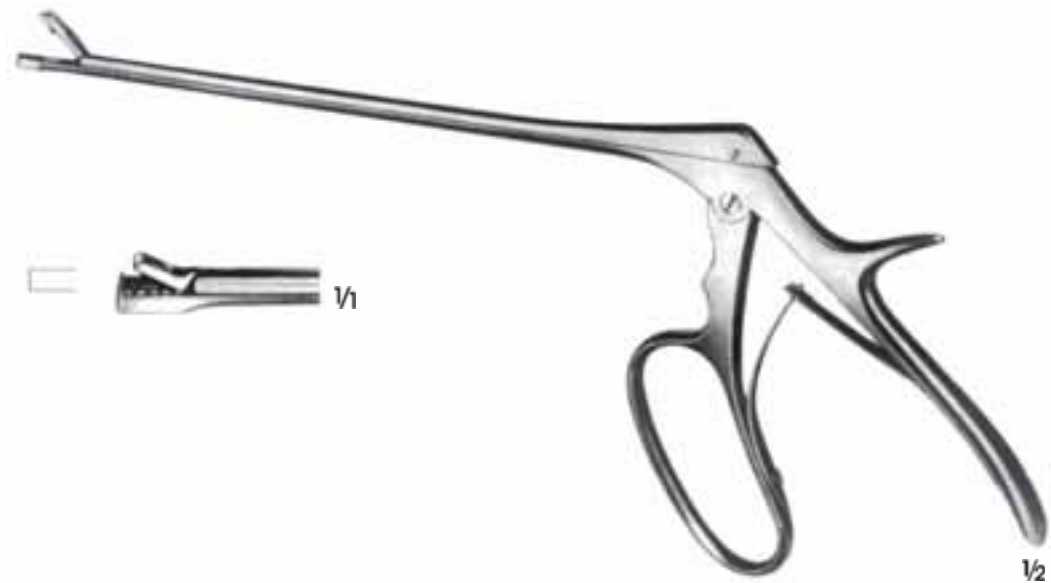

KEVORKIAN
R 752.01 20 cm
R 752.03 24 cm

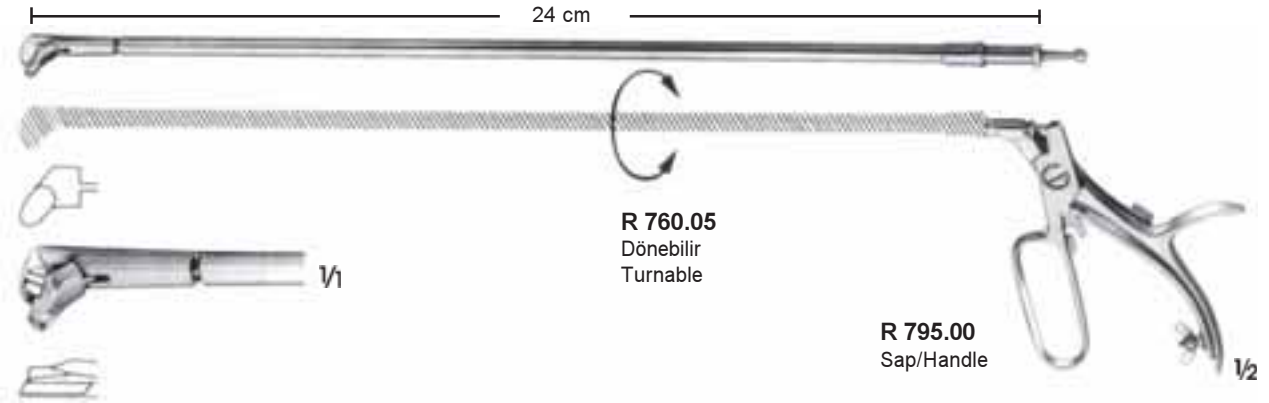

Uzatma şaftı
Extension cannulas



BRUENINGS
R 762.01 20 cm
R 762.02 25 cm
Uzatma şaftı/Extension cannulas

Biyopsi uçları
Biopsy tips



KRAUSE
R 770.00 **R 770.00 - R 770.01**



SCHEINMANN
R 772.00



SCHUMACHER
R 774.00

R 770.01

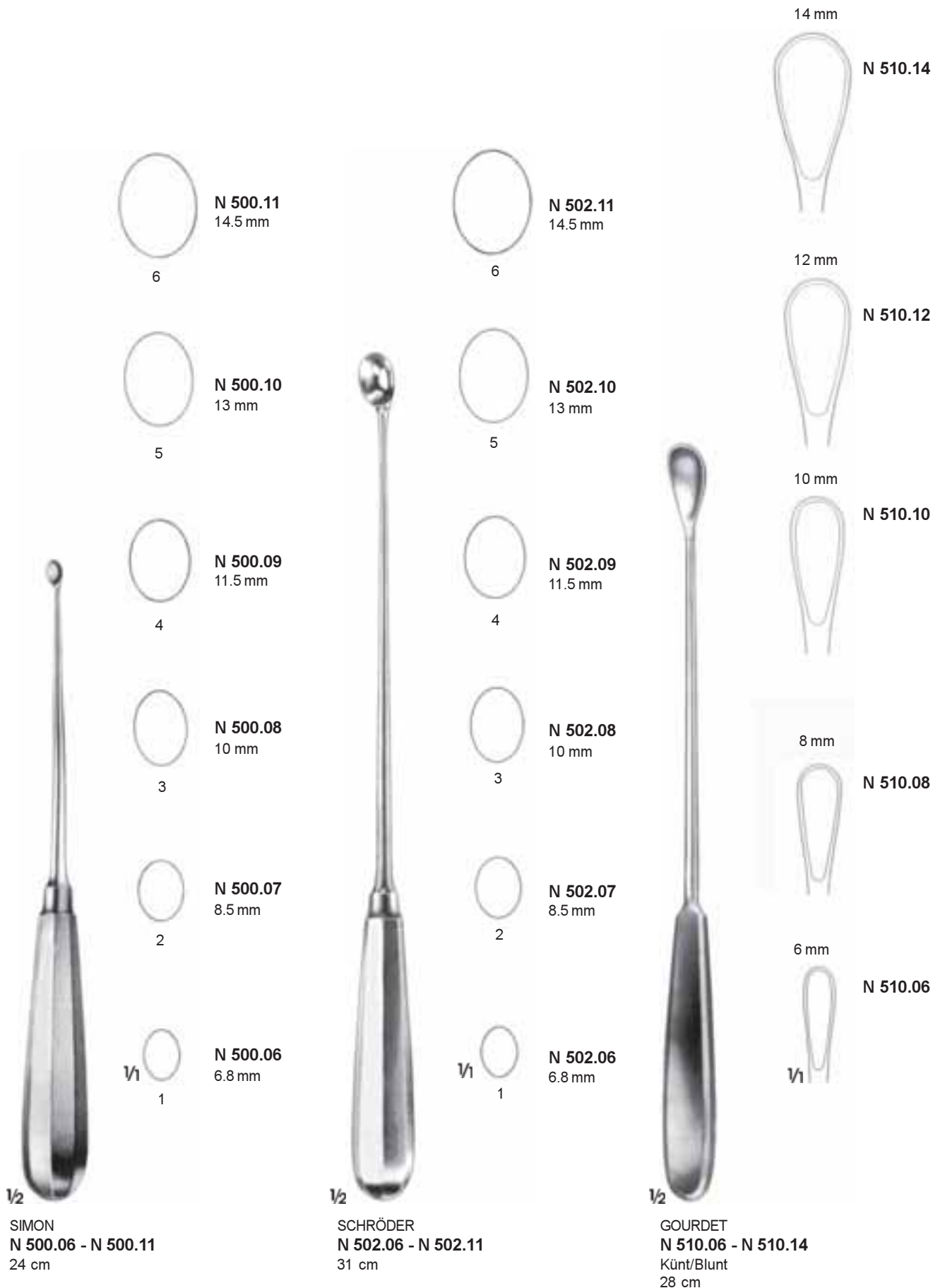



RECAMIER
N 520.04 - N 520.38
 Sivri-Rijid/Sharp-Rigid
N 525.09 - N 525.30
 Sivri-Bükülebilir/Sharp-Malleable
N 528.08 - N 528.38
 Künt-Rijid/Blunt-Rigid
 30 cm



N 520.34
N 528.34
 21.5 mm

9



N 520.27
N 525.27
N 528.27
 18 mm

7



N 520.21
N 525.21
N 528.21
 15 mm

5



N 520.15
N 525.15
N 528.15
 12 mm

3



N 520.09
N 525.09
N 528.09
 8.5 mm

1

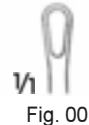

N 520.04
 4.5 mm

1/1

Fig. 00



N 520.38
N 528.38
 23.5 mm

10



N 520.30
N 525.30
N 528.30
 19.5 mm

8



N 520.24
N 525.24
N 528.24
 16.5 mm

6



N 520.19
N 525.19
N 528.19
 14 mm

4



N 520.12
N 525.12
N 528.12
 10.5 mm

2



N 520.08
N 528.08
 7.5 mm

1/1

Fig. 0



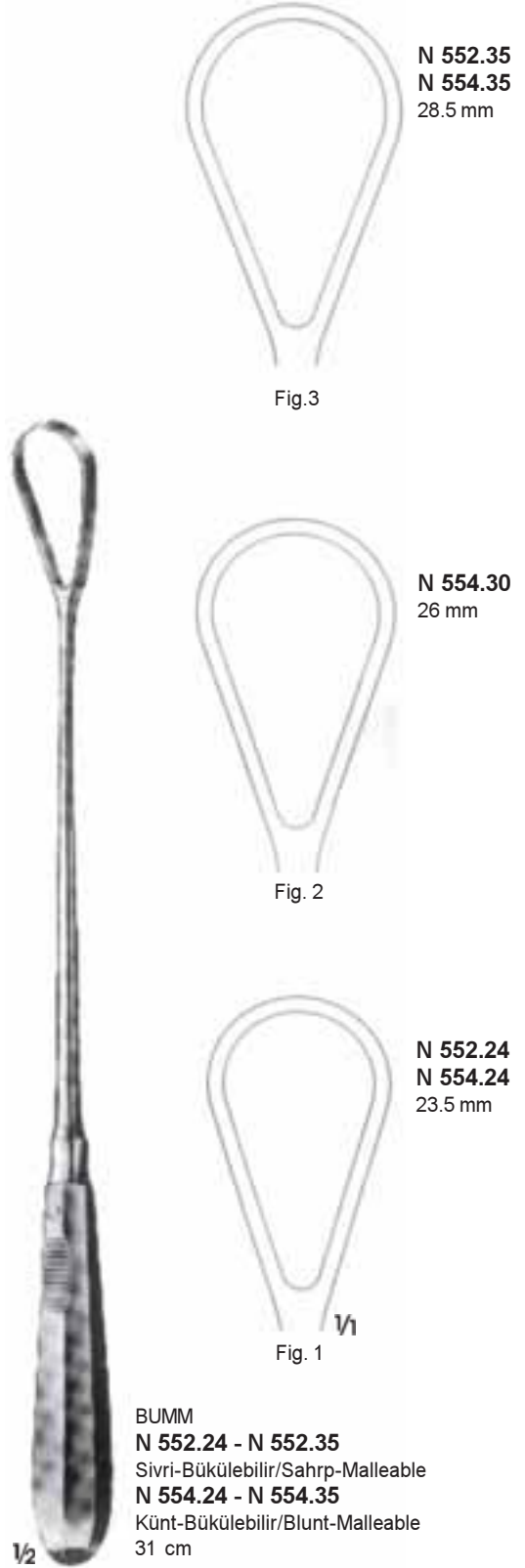
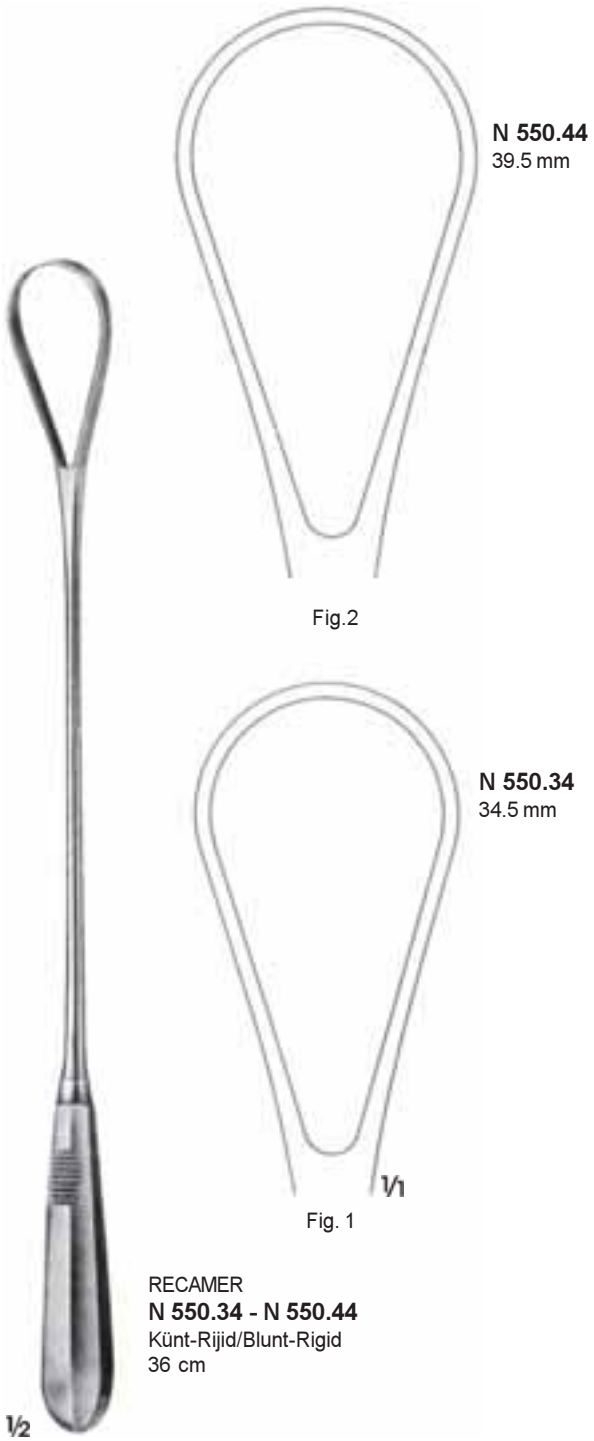



Künt/Blunt

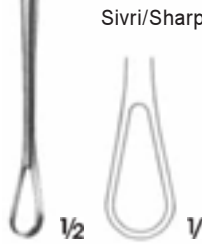

Sivri/Sharp

BLAKE
N 565.04
27.5 cm



1/1

COLLIN
N 560.05
30 cm



1/1

Kaşık/Scoop

WALLICH
N 570.08
42 cm





B 610.01
Poş açıcı
Poş opener
44 cm



BEACHAM
K 295.02
24 cm



HERFF
E 387.02
25.5 cm



1/2



IOWA
E 389.02
26 cm

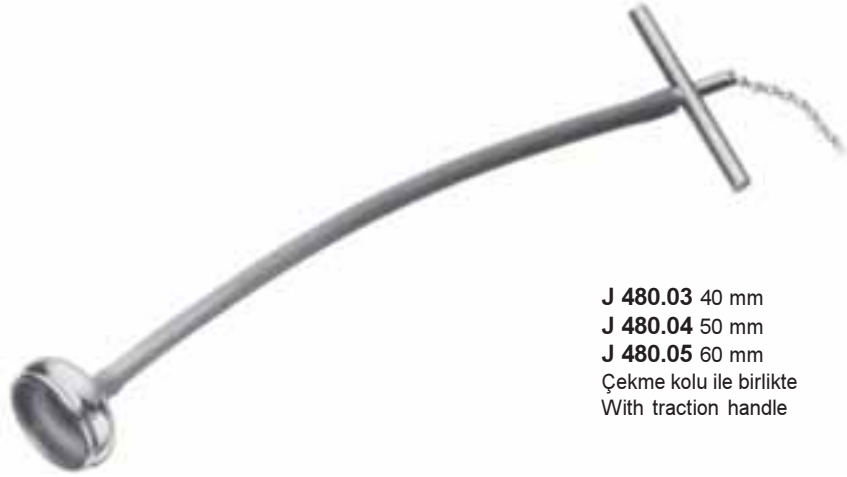

J 480.03 40 mm
J 480.04 50 mm
J 480.05 60 mm
Çekme kolu ile birlikte
With traction handle



J 480.10
El vanası ve bağlantı borusu
20 cm uzunluğunda bağlantı borusu
Hand valve with connection hose
20 cm long connection hose

Çalışması :

Arzu edilen (ihtiyaç duyulan) vakum miktarı ayarlama vidası ile sürekli olarak istenilen değere ayarlanabilir. Vakum oluştuğunda bu vakumun emme kafalarına uygulanması için hızlı-kesme düğmesinin sağa veya sola basılması ile sağlanır. Ayarlanan vakum değeri vakum ayar vidası ile değiştirilebilir. Emme işleminin aniden durdurulması isteniyorsa hızlı-kesme düğmesi kapatılır. Böylece emme kafasına gelen vakum kesilmiş ve emme kavanozuna akış durdurulmuş olur.

Function:

The vacuum required can be constantly preset by the adjusting screw. This vacuum exists then up to the closed quick-shutter, thus the vacuum in the suction head is pressed from the left to the right, the nounted suction head is immediately put under the preset vacuum. In case the preset vacuum has to be changed, this can be done with the adjusting screw. For immediate removal of the suction head simply close the quick-shutter, thus the vacuum in the suction head is eliminated at once whereas the vacuum in the suction jar remains unchanged.



C 600.00
10.5 cm



SCHUMACHER
C 602.00
15.5 cm



COLLIN
T 425.00
8.5 cm



C 603.00 - C 603.01



C 603.00
13.5 cm



C 603.01
16 cm



BRAUN-STADLER
C 604.00 - C 604.01

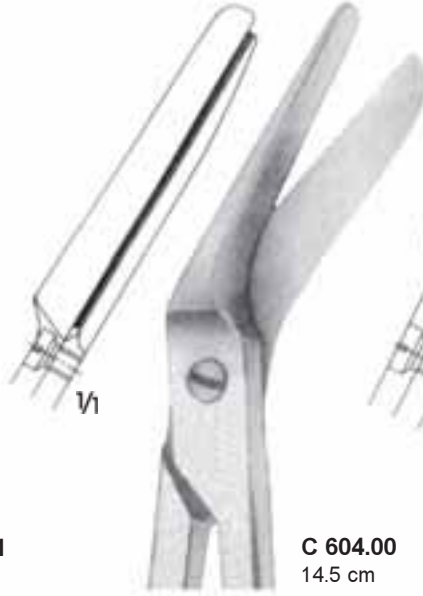

C 604.00
14.5 cm

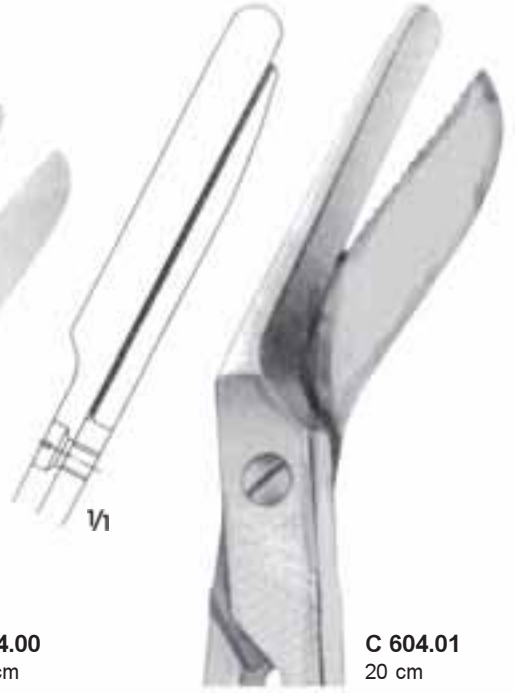

C 604.01
20 cm



1/2

C 610.00
24 cm



1/1



1/2

DUBOIS
C 612.02 - C 613.02
27.5 cm



C 612.02



C 613.02



1/3

SIMPSON-BRAUN
E 555.00
30.5 cm



1/3

SIMPSON-BRAUN
E 556.00
35 cm



1/3

NAGELE
E 557.02
35.5 cm



1/3

NAGELE
E 557.04
40 cm



1/3

SIMPSON
E 558.02
23.5 cm



1/3

WRIGLEY
E 559.02
25 cm



1/3

KIELLAND
E 565.02
42 cm



1/3

PIPER
E 567.02
44.5 cm



1/3

BOERMA
E 571.02
28 cm



1/3

MC.LEAN
E 572.02
36 cm



1/3

KIELLAND-LUIKARD
E 569.02
40 cm



1/3

SELHEIM
E 573.02
30 cm

Çekme çubuklu
With traction rod



1/3

TARNIER
E 578.04
40 cm

Çekme sapları
With traction handle



1/3

BARNES-NEVILLE
E 579.04
43.5 cm

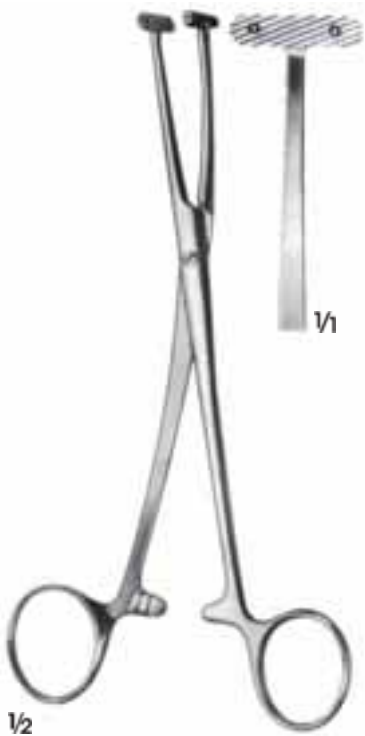

WILLETT
E 590.01
18.5 cm



GREEN-ARMYTAGE
E 594.02
22 cm



GAUSS
E 598.02
26 cm



WINTER
E 700.01 - E 700.03
29 cm



WINTER
E 702.01 - E 702.03
29 cm



WINTER
E 705.01 - E 705.02
29 cm



$\frac{1}{2}$
E 720.02



$\frac{1}{2}$
E 721.02



$\frac{1}{2}$
E 722.02



$\frac{1}{2}$

SAENGER
E 720.02
26.5 cm



$\frac{1}{2}$

SAENGER
E 721.02
27.5 cm



$\frac{1}{2}$

SAENGER
E 722.02
28.5 cm



1/1
E 740.02



E 730.02

1/1
E 731.02



1/1
E 710.02



1/2

MC.CLINTOCK
E 740.02
24 cm



1/2

LEWKOWITZ
E 730.02 - E 731.02
24.5 cm



1/2

E 710.02
28.5 cm



SIMELLIE
T 430.01
27 cm



BRAUN
T 435.01
42 cm



TARNIER
T 436.01
44 cm



BOER
E 735.02
29 cm



BRAUN
T 440.02
32.5 cm



Z 095.00 Komple/Complete
Cerrahi elektrodlar - Surgical electrodes

12 elektrodruk ray
Rack for 12 surgical electrodes
Ø 4 mm



Z 096.00
Kapaklı elektrod konteyneri
Container with lid for electrodes
25 cm
Z 097.00 Komple/Complete
Z 095.00 - Z 096.00



Z 001.00
Oval kesme elektrodu
Cutting electrode
Boy/Length 30 mm
En/Wide 3.5 mm



Z 002.00
Açılı kesme elektrodu
Angled cutting electrode
Boy/Length 14 mm
En/Wide 1.8 mm



Z 003.00
Kesme elektrodu, hassas
Cutting electrode, delicate
25 mm



Z 004.00
Bıçak elektrod
Knife electrode
25 mm



Z 005.00
Bıçak elektrod
Knife electrode
18 mm



Z 010.00
Plaka elektrod
Plate electrode



Z 006.00
Halkalı elektrodu
Loop electrode
Ø 10 mm
Tel Ø 3 mm/Wire Ø 3 mm



Z 009.00
Halkalı elektrodu
Loop electrode
Ø 15 mm



Z 012.00
Açılı Halkalı elektrodu
Angled Loop electrode
Ø 8 mm



Z 015.00 Ø 2.5 mm
Z 015.01 Ø 4 mm
Z 015.02 Ø 6 mm
Küresel uçlu
elektrodu
Ball point electrode



Z 016.00 Ø 0.3 mm
Z 016.01 Ø 0.5 mm
Z 016.02 Ø 0.7 mm
İğne elektrodu
Needle electrode
25 cm

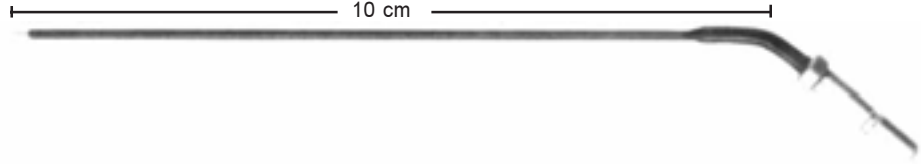

Z 045.00
İğne elektrod
Needle elektrode



Z 040.00
İğne elektrod
Needle elektrode



Z 041.00
Bıçak elektrod
Knife elektrode



Z 043.00
Halkalı elektrod
Wire loop elektrode



Z 043.01
Halkalı elektrod
Wire loop elektrode



Z 044.00
Halkalı elektrod
Wire loop elektrode
10 x 10 mm



Z 044.01
Halkalı elektrod
Wire loop elektrode
15 x 15 mm



Z 044.02
Halkalı elektrod
Wire loop elektrode
20 x 20 mm

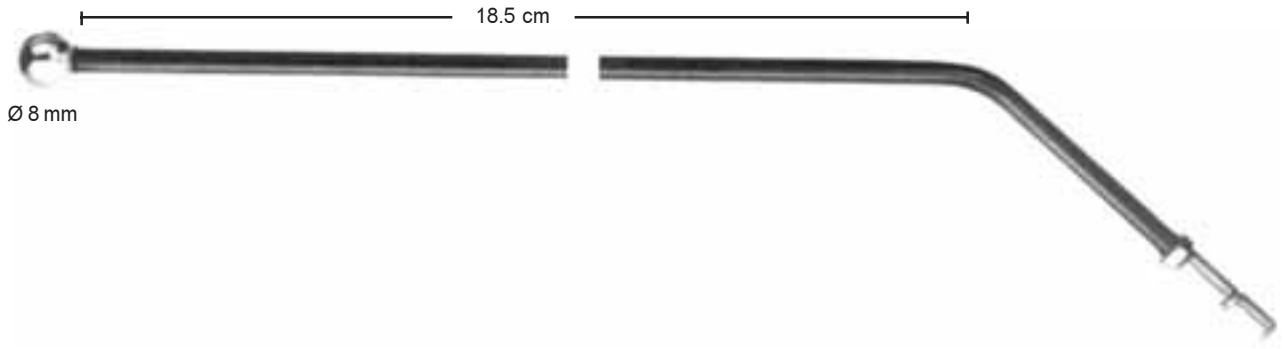

Z 046.00

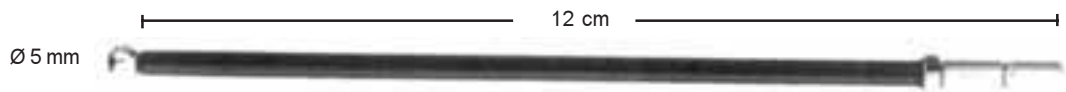

Z 048.00



Z 050.00
12 cm



Z 050.01
12 cm



Z 050.02
12 cm



Z 060.00
Elektrod tutucusu
Electrode holder



Z 309.00
Ayrılabilir aletler için kablo
Instrument Cable for detachable



Z 065.00
Bipolar kordon
Bipolar cord
2 mt.

Demontaj/Disassembly

Açık haldeki aleti uçlarından tutarak alet sapları üzerindeki bağlantı düğmesine basın. Alet sapını kapatarak bağlantı mekanizmasını açın, düğmeği bırakın

Hold the opened instrument at the tip and press the button at the instrument handle. Unlock the insert by closing the instrument handle. Release the button.



Alet sapını açma yönüne kuvvetlice itin, şaft yerinden çıkacaktır. Aletlerin ucundan tutarak şaftı çekin, dışarıya alın.

By opening the instrument handle with pressing towards the end of the insert, the insert clicks out of the arrest at the tip and can be taken out.



Montaj/Assembly

Düğmeye basarak açık durumdaki saptan şaftı kilit mekanizmasına itin.

Push the insert in the shaft by opened handle and pressed button.



Şaftı milin içine doğru iterken kilit mekanizmasının yerine oturmasına dikkat edin. Düğmeyi serbest bırakın.

By pushing the insert into the shaft pay attention to the correct fitting of tip and shaft arrest. Release the button at the instrument handle.



Alet sapının kapanmasıyla kilit mekanizması mil üzerindeki yuvasına oturacaktır. Alet şimdi kullanmaya hazırdır.

By closing the instrument handle the insert will click in the shaft arrest at the tip. The instrument is now ready for use.

Sap üzerinde kilitleme tertibatı bulunan aletler aynı şekilde kilidin aşağı bastırılmasıyla alet sökülür veya takılır.

Instruments with a ratchet at the instrument handle are to assemble and disassemble by pressing the ratchet down

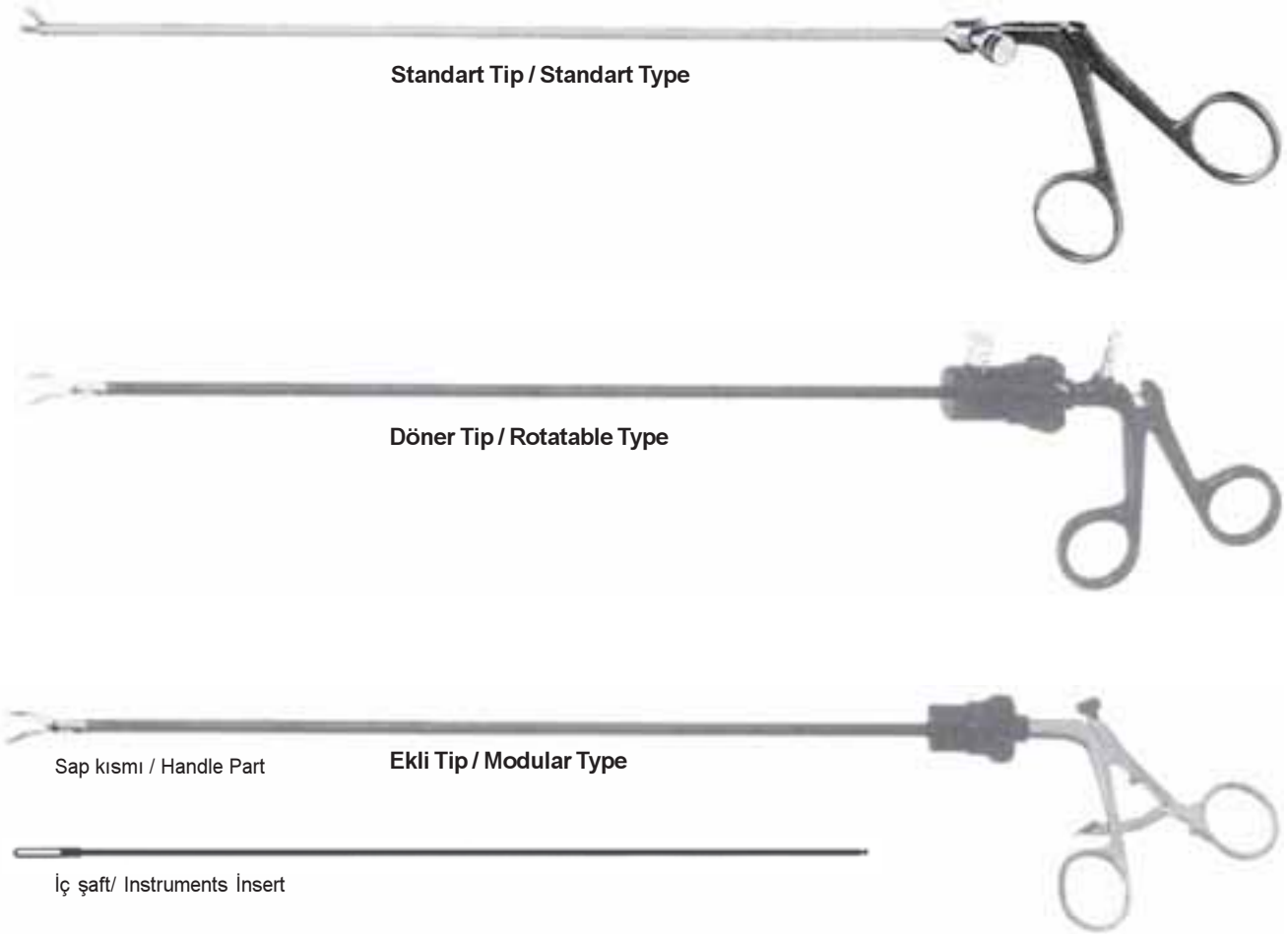

















Bütün Saplar Temizleme Delikli/All Handles with Cleaning Port









Ø	Handle only uninsulated Yalnız izolesiz saplar	Handle only uninsulated Ratchet Yalnız izolesiz saplar Kilitli	Handle only uninsulated Yalnız izolesiz saplar	Handle only uninsulated Ratchet Yalnız izolesiz saplar Kilitli
5 mm	X 690.01	X 690.02	X 690.03	X 690.04
10 mm	X 691.01	X 691.02	X 691.03	X 691.04









- * 360°'lik dönüş klinik bir esneklik sağlar.
- * Geniş bir pens ve makas seçimi
- * Daha düşük depolama alanı
- * Sapın kapatılmasıyla aletin dönüşünün kontrollü biçimde durdurulması
- * Ucu ve sapın çabuk bir hareketle çıkartılması ve yeniden yerine takılması
- * Birbirinden ayrılmış parçaların çabuk ve etkili bir şekilde temizliği ve sterilizasyonu
- * Ameliyat ve envanter harcama ve masraflarında önemli ölçüde düşüş
- * Tamamen otoklav edilebilir
- * Ucu ve sapın güvenli ve emniyetli bir şekilde montajı
- * Kullanışlı sap tasarımı
- * Aletlerin tek elle kolay ve hassas bir şekilde kullanımı
- * Alet bağlantısındaki ve sap kısmındaki kombinasyon









- * 360° degree rotation ensures clinical flexibility
- * Large selection of interchanging forceps and scissors
- * Reduced storage space
- * Controlled stop of instrument rotation when closing handle
- * Fast-action take-out and reassembly of insert and handle
- * Quick and efficient cleaning and sterilisation of detached parts
- * Considerable reduction of O.R. charges and inventory costs
- * Completely autoclaveable
- * Safe and secure assembly of inserts and handle
- * Ergonomic handle design
- * Easy and precise one-hand use of instruments
- * Combination of handle part and instrument insert









Uc Tipi / Jaw Type	Tip Type	İzolesiz Uninsulated	İzolesiz-Kilitli Unins-Ratchet	İzoleli Insulated	İzoleli-Kilitli Insu-Ratchet	Sadece uç Insert Only
 HOOK SCISSORS 5 mm	Sabit Standart	X 100.01		X 100.03		
	Dönerli Rotation	X 101.01		X 101.03		
	Modüler Modular	X 102.01		X 102.03		X 102.05
 PERITONEAL SCISSORS 5 mm Tırtıllı ağız, künt/Serrated jaw blunt	Sabit Standart	X 103.01		X 103.03		
	Dönerli Rotation			X 104.03		
	Modüler Modular	X 105.01		X 105.03		X 105.05
 PERITONEAL SCISSORS 5 mm Tırtıllı ağız, sivri/Serrated jaw sharp	Sabit Standart	X 106.01		X 106.03		
	Dönerli Rotation			X 107.03		
	Modüler Modular	X 108.01		X 108.03		X 108.05
 METZENBAUM SCISSORS 5 mm Düz/Straight	Sabit Standart	X 109.01		X 109.03		
	Dönerli Rotation			X 110.03		
	Modüler Modular	X 111.01		X 111.03		X 111.05
 METZENBAUM SCISSORS 5 mm Eğri/Curved	Sabit Standart	X 112.01		X 112.03		
	Dönerli Rotation	X 113.01		X 113.03		
	Modüler Modular	X 114.01		X 114.03		X 114.05
 MICRO SCISSORS 5 mm Düz/Straight	Sabit Standart	X 115.01				
	Dönerli Rotation	X 116.01				
	Modüler Modular					
 MICRO SCISSORS 5 mm Eğri/Curved	Sabit Standart	X 118.01				
	Dönerli Rotation	X 119.01				
	Modüler Modular					
 OP - SCISSORS 10 mm Düz/Straight	Sabit Standart	X 121.01				
	Dönerli Rotation					
	Modüler Modular	X 123.01		X 123.03		X 123.05









Uc Tipi / Jaw Type	Tip Type	İzolesiz Uninsulated	İzolesiz-Kilitli Unins-Ratchet	İzoleli Insulated	İzoleli-Kilitli Insu-Ratchet	Sadece uc Insert Only
 DOLPHIN DISSECT. and GRASP. FCPS With spoon 5 mm	Sabit Standart	X 124.01	X 124.02	X 124.03		
	Dönerli Rotation	X 125.01		X 125.03		
	Modüler Modular	X 126.01	X 126.02	X 126.03		X 126.05
 DISSECT. and GRASP. FCPS Tapered end 5 mm	Sabit Standart	X 127.01	X 127.02	X 127.03		
	Dönerli Rotation	X 128.01		X 128.03		
	Modüler Modular	X 129.01	X 129.02	X 129.03		X 129.05
 DISSECT. and GRASP. FCPS Blunt with spoon 5 mm	Sabit Standart	X 130.01	X 130.02	X 130.03		
	Dönerli Rotation	X 131.01		X 131.03		
	Modüler Modular	X 132.01	X 132.02	X 132.03		X 132.05
 DE BAKEY Jaw length 20 mm, 5 mm	Sabit Standart		X 133.02			X 133.05
	Dönerli Rotation		X 134.02			
	Modüler Modular	X 135.01	X 135.02	X 135.03		X 135.05
 DISSECT. and GRASP. FCPS Blunt 5 mm	Sabit Standart	X 136.01		X 136.03		
	Dönerli Rotation					
	Modüler Modular	X 138.01	X 138.02	X 138.03		X 138.05
 DUCK BILL DISSECT. and GRASP. FCPS 5 mm	Sabit Standart		X 139.02			
	Dönerli Rotation					
	Modüler Modular	X 141.01	X 141.02	X 141.03	X 141.04	X 141.05
 DISSECT. and GRASP. FCPS Narrow jaw 5 mm	Sabit Standart	X 142.01	X 142.02	X 142.03		X 142.05
	Dönerli Rotation					
	Modüler Modular	X 144.01	X 144.02	X 144.03		X 144.05
 MARYLAND DISSECTOR Short jaw curved left 5 mm	Sabit Standart	X 145.01	X 145.02	X 145.03		X 145.05
	Dönerli Rotation	X 146.01	X 146.02	X 146.03		X 146.05
	Modüler Modular	X 147.01	X 147.02	X 147.03		X 147.05





Uc Tipi / Jaw Type	Tip Type	İzolesiz Uninsulated	İzolesiz-Kilitli Unins-Ratchet	İzoleli Insulated	İzoleli-Kilitli Insu-Ratchet	Sadece uc Insert Only
 BIOPSY FORCEPS Spoon jaw with pin 5 mm	Sabit Standart	X 500.01		X 500.03		
	Dönerli Rotation					
	Modüler Modular	X 502.01		X 502.03		X 502.05
 BIOPSY FORCEPS Spoon jaw 5 mm	Sabit Standart	X 503.01		X 503.03		
	Dönerli Rotation					
	Modüler Modular	X 505.01		X 505.03		X 505.05
 BIOPSY FORCEPS With pin 5 mm	Sabit Standart	X 506.01		X 506.03		
	Dönerli Rotation	X 507.01		X 507.03		
	Modüler Modular	X 508.01		X 508.03		X 508.05
 SCHERTL GRASPING FCPS Fenestrated 5 mm	Sabit Standart		X 148.02		X 148.04	
	Dönerli Rotation		X 149.02			
	Modüler Modular	X 150.01	X 150.02	X 150.03	X 150.04	X 150.05
 FUNDUS GRASPING FCPS 5 mm	Sabit Standart		X 151.02		X 151.04	
	Dönerli Rotation		X 152.02			
	Modüler Modular	X 153.01	X 153.02	X 153.03	X 153.04	X 153.05
 ALLIGATOR GRAS. FCPS 5 mm	Sabit Standart		X 154.02		X 154.04	
	Dönerli Rotation		X 155.02			
	Modüler Modular	X 156.01	X 156.02	X 156.03	X 156.04	X 156.05
 COBRA GRAS. FCPS 5 mm	Sabit Standart		X 157.02		X 157.04	
	Dönerli Rotation					
	Modüler Modular	X 159.01	X 159.02	X 159.03	X 159.04	X 159.05
 GRASPING FCPS Fenestrated 5 mm	Sabit Standart		X 160.02	X 160.03	X 160.04	
	Dönerli Rotation		X 161.02			
	Modüler Modular	X 162.01	X 162.02	X 162.03	X 162.04	X 162.05

Uc Tipi / Jaw Type	Tip Type	İzolesiz Uninsulated	İzolesiz-Kilitli Unins-Ratchet	İzoleli Insulated	İzoleli-Kilitli Insu-Ratchet	Sadece uc Insert Only
 DORSEY INTESTINAL FCPS Jaw length 40mm, 5 mm	Sabit Standart		X 163.02			
	Dönerli Rotation					
	Modüler Modüler		X 165.02			X 165.05
 ALLIS GRASPING FCPS 5 mm	Sabit Standart		X 166.02			
	Dönerli Rotation					
	Modüler Modüler		X 168.02			X 168.05
 BIOPSY PUNCH FCPS Cut thru type 5 mm	Sabit Standart	X 509.01		X 509.03		
	Dönerli Rotation					
	Modüler Modüler					
 FRANGENHEIM BIOPSY PUNCH FCPS Cut thru type 5 mm	Sabit Standart	X 512.01		X 512.03		
	Dönerli Rotation					
	Modüler Modüler					
 GRASPING FORCEPS 5 mm	Sabit Standart	X 169.01	X 169.02		X 169.04	
	Dönerli Rotation					
	Modüler Modüler	X 171.01	X 171.02	X 171.03	X 171.04	X 171.05
 COBRA GRASPING FCPS 5 mm	Sabit Standart		X 172.02		X 172.04	
	Dönerli Rotation					
	Modüler Modüler	X 174.01	X 174.02	X 174.03	X 174.04	X 174.05
 NEEDLE NOSE GRASPING FCPS Delicate jaw 5 mm	Sabit Standart		X 175.02		X 175.04	
	Dönerli Rotation					
	Modüler Modüler	X 177.01	X 177.02	X 177.03	X 177.04	X 177.05
 ALLIS GRASPING FCPS 5 mm	Sabit Standart	X 178.01	X 178.02		X 178.04	
	Dönerli Rotation					
	Modüler Modüler	X 180.01	X 180.02	X 180.03	X 180.04	X 180.05

Uc Tipi / Jaw Type	Tip Type	İzolesiz Uninsulated	İzolesiz-Kilitli Unins-Ratchet	İzoleli Insulated	İzoleli-Kilitli Insu-Ratchet	Sadece uc Insert Only
 ALLIS GRASPING FCPS Delicate jaw 5 mm	Sabit Standart	X 181.01	X 181.02		X 181.04	
	Dönerli Rotation					
	Modüler Modüler	X 183.01	X 183.02	X 183.03	X 183.04	X 183.05
 CLAW FORCEPS 5 mm	Sabit Standart		X 184.02			
	Dönerli Rotation					
	Modüler Modüler		X 186.02		X 186.04	
 NEEDLE NOSE GRAS. FCPS Delicate jaw 5 mm	Sabit Standart		X 187.02		X 187.04	
	Dönerli Rotation					
	Modüler Modüler	X 189.01	X 189.02	X 189.03	X 189.04	X 189.05
 STRONG GRASPING FCPS 5 mm	Sabit Standart		X 190.02			
	Dönerli Rotation					
	Modüler Modüler		X 192.02			X 192.05
 GRASPING FORCEPS 5 mm	Sabit Standart		X 193.02			
	Dönerli Rotation					
	Modüler Modüler		X 195.02			X 195.05
 BOWEL GRASPING FCPS 5 mm	Sabit Standart		X 196.02			
	Dönerli Rotation					
	Modüler Modüler		X 198.02			X 198.05
 ATRAUMATIC GRA. FCPS 5 mm	Sabit Standart		X 199.02			
	Dönerli Rotation					
	Modüler Modüler		X 201.02			X 201.05
 BOWEL FORCEPS 5 mm	Sabit Standart		X 202.02			
	Dönerli Rotation					
	Modüler Modüler		X 204.02			X 204.05

Uc Tipi / Jaw Type	Tip Type	İzolesiz Uninsulated	İzolesiz-Kilitli Unins-Ratchet	İzoleli Insulated	İzoleli-Kilitli Insu-Ratchet	Sadece uc Insert Only
 DISSEC. and GRASP. FCPS 5 mm	Sabit Standart			X 205.03		
	Dönerli Rotation					
	Modüler Modüler			X 207.03		X 207.05
 ALLIS GRASPING FCPS 5 mm	Sabit Standart		X 208.02			
	Dönerli Rotation					
	Modüler Modüler		X 210.02			X 210.05
 ALLIS GRASPING FCPS 5 mm	Sabit Standart		X 211.02			
	Dönerli Rotation					
	Modüler Modüler		X 213.02			X 213.05
 MIXTER DISSECTING FCPS Right angled, 5 mm	Sabit Standart			X 214.03		
	Dönerli Rotation			X 215.03		
	Modüler Modüler			X 216.03		X 216.05
 MICRO GRASPING FCPS 5 mm	Sabit Standart	X 217.01				
	Dönerli Rotation					
	Modüler Modüler					
 MICRO BIOPSY FCPS Spoon-shaped, 5 mm	Sabit Standart	X 515.01				
	Dönerli Rotation					
	Modüler Modüler					
 GRASPING BIOPSY FCPS 5 mm	Sabit Standart		X 518.02			
	Dönerli Rotation					
	Modüler Modüler		X 520.02			X 520.05
 BLAKESLY BIOPSY FCPS 5 mm	Sabit Standart	X 521.01		X 521.03		
	Dönerli Rotation					
	Modüler Modüler	X 523.01		X 523.03		X 523.05

Uc Tipi / Jaw Type	Tip Type	İzolesiz Uninsulated	İzolesiz-Kilitli Unins-Ratchet	İzoleli Insulated	İzoleli-Kilitli Insu-Ratchet	Sadece uc Insert Only
 GRASPING FORCEPS Blunt, 5 mm	Sabit Standart			X 220.03		
	Dönerli Rotation					
	Modüler Modüler	X 222.01	X 222.02	X 222.03	X 222.04	X 222.05
 ALLIS GRASPING FORCEPS Fenestrated short jaw, 5 mm	Sabit Standart		X 223.02			
	Dönerli Rotation					
	Modüler Modüler	X 225.01	X 225.02	X 225.03	X 225.04	X 225.05
 ALLIS GRASPING FORCEPS Fenestrated long jaw, 5 mm	Sabit Standart		X 226.02			
	Dönerli Rotation					
	Modüler Modüler	X 228.01	X 228.02	X 228.03	X 228.04	X 228.05
 STRONG GRASPING FORCEPS Fenestrated, 5 mm	Sabit Standart		X 229.02			
	Dönerli Rotation					
	Modüler Modüler	X 231.01	X 231.02	X 231.03	X 231.04	X 231.05
 GRASPING FORCEPS Toothed jaw, sharp, 5 mm	Sabit Standart	X 232.01				
	Dönerli Rotation					
	Modüler Modüler	X 234.01	X 234.02	X 234.03		X 234.05
 DISSECTING FORCEPS 5 mm	Sabit Standart	X 235.01				
	Dönerli Rotation					
	Modüler Modüler	X 237.01	X 237.02	X 237.03		X 237.05
 TISSUE GRASPING FORCEPS 5 mm	Sabit Standart	X 238.01				
	Dönerli Rotation					
	Modüler Modüler	X 240.01	X 240.02	X 240.03		X 240.05
 FORCEPS 5 mm	Sabit Standart	X 524.01		X 524.03		
	Dönerli Rotation					
	Modüler Modüler	X 526.01		X 526.03		X 526.05

Uc Tipi / Jaw Type	Tip Type	İzolesiz Uninsulated	İzolesiz-Kilitli Unins-Ratchet	İzoleli Insulated	İzoleli-Kilitli Insu-Ratchet	Sadece uc Insert Only
 DISSEC. and GRASP FCPS 5 mm	Sabit Standart	X 527.01		X 527.03		
	Dönerli Rotation					
	Moduler Modular	X 529.01		X 529.03		X 529.05
 GRASPING FORCEPS 5 mm	Sabit Standart	X 530.01		X 530.03		
	Dönerli Rotation					
	Moduler Modular	X 532.01		X 532.03		X 532.05
 GRASPING FORCEPS 5 mm	Sabit Standart	X 533.01				
	Dönerli Rotation					
	Moduler Modular	X 535.01		X 535.03		X 535.05
 DISSECTING FORCEPS 5 mm	Sabit Standart	X 536.01		X 536.03		
	Dönerli Rotation					
	Moduler Modular	X 538.01		X 538.03		X 538.05
 CLAW FORCEPS 10 mm	Sabit Standart		X 615.02			
	Dönerli Rotation					
	Moduler Modular		X 617.02			X 617.05



X 750.00
Fiksasyon klemp, kilitli
Fixation clamp, with ratched
5 mm

X 700.00

Değiştirilebilir uçlar için elcek. Uç korumalı sisteme sahip.
Axial handle only for needle holder tips with protective devices



X 700.01

Değiştirilebilir sert metal uclu portegü, düz 5 mm
Axial handle only for needle holder tip, straight 5 mm

X 700.02

Sadece uçTip only



X 701.01

Değiştirilebilir sert metal uclu portegü, sol 5 mm
Axial handle only for needle holder tip, left 5 mm

X 701.02

Sadece uçTip only



X 702.01

Değiştirilebilir sert metal uclu portegü, sağ 5 mm
Axial handle only for needle holder tip, right 5 mm

X 702.02

Sadece uçTip only



X 705.01

Sert metal uclu portegü, yaylı elceklı 5 mm
TC- needle holder, ring nadle with spring 5 mm

X 705.02

Sert metal uclu portegü, kilitli elceklı 5 mm
TC- needle holder, ring nadle with ratchet 5 mm



X 706.01

Portegü, yaylı elceklı 5 mm
Needle holder, ring nadle with spring 5 mm

X 706.02

Portegü, kilitli elceklı 5 mm
Needle holder, ring nadle with ratchet 5 mm



X 707.01

Portegü, yaylı elceklı 3 mm
Needle holder, ring nadle with spring 3 mm

X 707.02

Portegü, kilitli elceklı 3 mm
Needle holder, ring nadle with ratchet 3 mm



Klip aplikatörü 10 mm / Clip applying forceps 10 mm

X 751.01



X 751.02





Trokar, konik uç
Trocar, conical

Trokar, pramid uç
Trocar, pyramidal

Klavuz, boru vafli
Sleeve, with automatic valve

Trokar, konik uç
Trocar, conical

Trokar, pramid uç
Trocar, pyramidal

Klavuz, otomatik
vafli
Sleeve, with automatic valve

BORU VALF / TRUMPET VALVE	Ø	Trokar ve Klavuz Pramid uç Trocar and Sleeve Pyramidal	Trokar ve Klavuz Konik uç Trocar and Sleeve Conical	Sadece klavuz Sleeve only	Sadece trokar Pramid uç Trocar only Pyramidal	Sadece trokar Konik uç Trocar only Conical
		5 mm	J 152.01	J 152.02	J 152.03	J 152.04
5.5 mm	J 153.01	J 153.02	J 153.03	J 153.04	J 153.05	
8 mm	J 154.01	J 154.02	J 154.03	J 154.04	J 154.05	
11 mm	J 155.01	J 155.02	J 155.03	J 155.04	J 155.05	
15 mm	J 156.01	J 156.02	J 156.03	J 156.04	J 156.05	
20 mm	J 157.01	J 157.02	J 157.03	J 157.04	J 157.05	
OTOMATİK VALF / AUTOMATIC VALVE	5 mm	J 158.01	J 158.02	J 158.03	J 158.04	J 158.05
	5.5 mm	J 159.01	J 159.02	J 159.03	J 159.04	J 159.05
	6 mm	J 160.01	J 160.02	J 160.03	J 160.04	J 160.05
	7 mm	J 161.01	J 161.02	J 161.03	J 161.04	J 161.05
	8 mm	J 162.01	J 162.02	J 162.03	J 162.04	J 162.05
	10 mm	J 163.01	J 163.02	J 163.03	J 163.04	J 163.05
	11 mm	J 164.01	J 164.02	J 164.03	J 164.04	J 164.05
	12 mm	J 165.01	J 165.02	J 165.03	J 165.04	J 165.05



J 150.03 5.5 mm / 3.0 mm
J 150.04 10.0 mm / 5.5 mm
J 150.05 11.5 mm / 5.5 mm
J 150.06 12.5 mm / 5.5 mm
J 150.07 12.5 mm / 10.0 mm



J 151.01 5.0 mm
J 151.02 5.5 mm
J 151.03 10.0 mm
J 151.04 10.5 mm
J 151.05 11.0 mm
J 151.06 12.5 mm

 J 171.01

 J 171.02

 J 171.03

 J 171.04

 J 171.05

 J 171.06

 J 171.07

Aspirasyon ve yıkama seti, değiştirilebilir iki valfli elcekle birlikte
Suction/irrigation tube set, interchangeable handle with two valves



J 161.00
Değiştirilebilir çift valfli elcek
Interchangeable handle with two valves

J 172.00
Aspirasyon ve yıkama seti, değiştirilebilir
Ø 5 mm ve Ø 10 mm uçları ile birlikte
Suction / irrigation unit, interchangeable
tubes Ø 5 mm and Ø 10 mm



J 172.01
Ø 10 mm

J 172.02
Ø 5 mm

J 173.00
Aspirasyon ve yıkama ucu, iki valfli ve derinlik işaretli
Suction / irrigation tube with two valves, graduated



COHEN
J 952.00
Uterin kanülü
Intrauterine cannula



T 905.05
Mayoma matkabi
Mayoma drill
Ø 5 mm



T 905.10
Mayoma matkabi
Mayoma drill
Ø 10 mm



QUINONOS
E 112.01
Uterin tutma pensi
Uterine grasping forceps
25 cm



QUINONOS-NEUBUSER
E 112.02
Uterin tutma pensi
Uterine grasping forceps
25 cm



SCHROEDER
E 251.00
Uterin tenekulum pensi
Uterine tenaculum forceps
25 cm

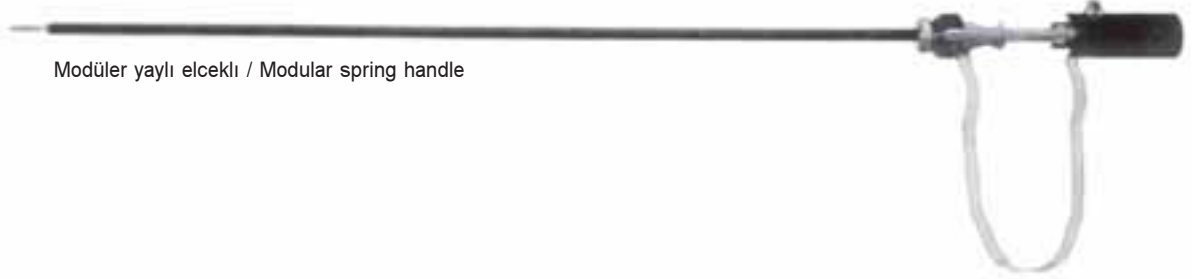

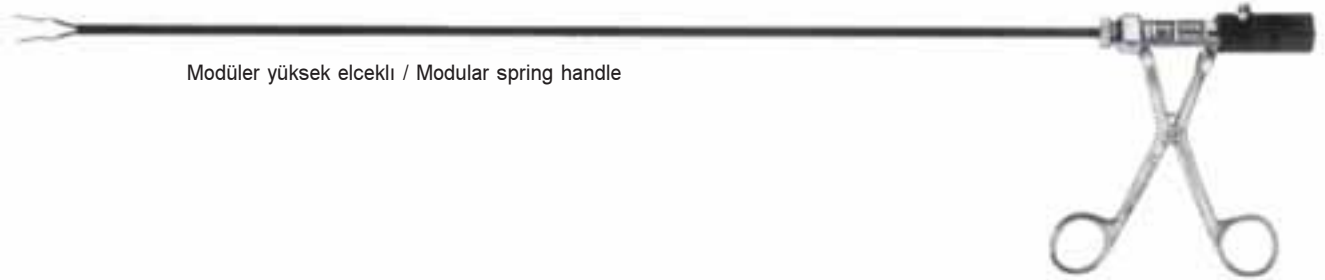

Modüler yaylı elceklı / Modular spring handle



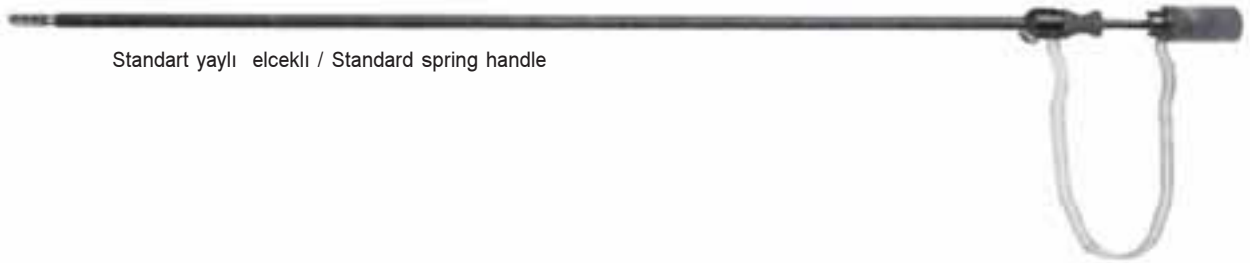



Modüler yüksek elceklı / Modular spring handle



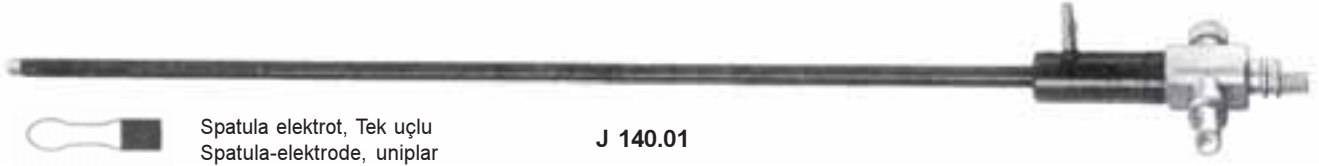



Standart yaylı elceklı / Standard spring handle

Uc Tipi / Jaw Type	Tip Type	İzoleli Insulated	İzolesiz Uninsulated	Sadece uç Insert only	Sadece izoleli tüp Insulated tube Only	Sadece izolesiz tüp Uninsulated tube Only	Sadece elcek Handle only
 BIPOLAR COAGULATION FCP 5 mm fenestrated length 33 cm	Modüler yaylı Modular spring	Z 300.01	Z 300.02	Z 300.03	Z 300.04	Z 300.05	Z 300.06
	Modüler yüksek Modular ring	Z 301.01	Z 301.02	Z 301.03	Z 301.04	Z 301.05	Z 301.06
	Standart yaylı Standard spring		Z 302.02				
 BIPOLAR COAGULATION FCP 5 mm jaw 3 mm wide length 33 cm	Modüler yaylı Modular spring	Z 303.01	Z 303.02	Z 303.03	Z 303.04	Z 303.05	Z 303.06
	Modüler yüksek Modular ring	Z 304.01	Z 304.02	Z 304.03	Z 304.04	Z 304.05	Z 304.06
	Standart yaylı Standard spring		Z 305.02				







	Spatula elektrot, Tek uçlu Spatula-elektrode, uniplar	J 140.01
	Kancalı elektrot "J" Hook elektrode "J"	J 140.02
	Kancalı elektrot "L" Hook elektrode "L"	J 140.03
	Buton elektrot Button elektrode	J 140.04



	Spatula elektrot, içi dolu Coagulation Spatula-elektrode, solid	J 141.01
	Huk elektrot "J", içi dolu Hook elektrode "J", solid	J 141.02
	Huk elektrot "L", içi dolu Hook elektrode "L", solid	J 141.03
	Buton elektrot, içi dolu Coagulation button -elektrode, solid	J 141.04



	Spatula elektrot, Tek uçlu Spatula-elektrode, uniplar	J 142.01
	Yalnız Uç/Tip, only	J 142.02
	Huk elektrot "J" Hook elektrode "J"	J 142.03
	Yalnız Uç/Tip, only	J 142.04
	Huk elektrot "L" Hook elektrode "L"	J 142.05
	Yalnız Uç/Tip, only	J 142.06
	Küresel elektrot/Düğme eektrot Ball elektrode/Button Elektrode	J 142.07
	Yalnız Uç/Tip, only	J 142.08



Trokar, konik uç
Trocar, conical



Trokar, pramid uç
Trocar, pyramidal



Klavuz, boru vafli
Sleeve, with automatic valve

BORU VALF / TRUMPET VALVE	Ø	Trokar ve Klavuz Pramid uç Trocar and Sleeve Pyramidal	Trokar ve Klavuz Konik uç Trocar and Sleeve Conical	Sadece klavuz Sleeve only	Sadece trokar Pramid uç Trocar only Pyramidal	Sadece trokar Konik uç Trocar only Conical
		5 mm	J 152.01	J 152.02	J 152.03	J 152.04
5.5 mm	J 153.01	J 153.02	J 153.03	J 153.04	J 153.05	
8 mm	J 154.01	J 154.02	J 154.03	J 154.04	J 154.05	
11 mm	J 155.01	J 155.02	J 155.03	J 155.04	J 155.05	
15 mm	J 156.01	J 156.02	J 156.03	J 156.04	J 156.05	
20 mm	J 157.01	J 157.02	J 157.03	J 157.04	J 157.05	



J 150.03 5.5 mm / 3.0 mm
J 150.04 10.0 mm / 5.5 mm
J 150.05 11.5 mm / 5.5 mm
J 150.06 12.5 mm / 5.5 mm
J 150.07 12.5 mm / 10.0 mm



J 151.01 5.0 mm
J 151.02 5.5 mm
J 151.03 10.0 mm
J 151.04 10.5 mm
J 151.05 11.0 mm
J 151.06 12.5 mm



Teleskop/Telescope 0°

A 908.00 Standart/Standard

A 909.00 Otoklav edilebilir/Autoclavable
Ø 10.0 mm, 31 cm



Teleskop/Telescope 30°

A 908.30 Standart/Standard

A 909.30 Otoklav edilebilir/Autoclavable
Ø 10.0 mm, 31 cm



Araştırma probu
Exploratory probe

H 810.01 33 cm

H 810.02 45 cm



Küçültme elemanı
Reducer instrument

T 802.05 8 - 5.5 mm

T 802.06 11 - 5.5 mm

T 802.11 15 - 11 mm

T 802.15 20 - 15 mm



STERIL CONTAINER SYSTEM



Types and Dimensions

Bottom Non Perforated



Bottom Perforated



580 x 280 x 100 mm



- Y 110.10
- Y 120.10
- Y 130.10
- Y 140.10
- Y 150.10
- Y 160.10

- Y 111.10
- Y 121.10
- Y 131.10
- Y 141.10
- Y 151.10
- Y 161.10

580 x 280 x 135 mm



- Y 110.13
- Y 120.13
- Y 130.13
- Y 140.13
- Y 150.13
- Y 160.13

- Y 111.13
- Y 121.13
- Y 131.13
- Y 141.13
- Y 151.13
- Y 161.13

580 x 280 x 150 mm



- Y 110.15
- Y 120.15
- Y 130.15
- Y 140.15
- Y 150.15
- Y 160.15

- Y 111.15
- Y 121.15
- Y 131.15
- Y 141.15
- Y 151.15
- Y 161.15

580 x 280 x 200 mm



- Y 110.20
- Y 120.20
- Y 130.20
- Y 140.20
- Y 150.20
- Y 160.20

- Y 111.20
- Y 121.20
- Y 131.20
- Y 141.20
- Y 151.20
- Y 161.20

580 x 280 x 260 mm



- Y 110.26
- Y 120.26
- Y 130.26
- Y 140.26
- Y 150.26
- Y 160.26

- Y 111.26
- Y 121.26
- Y 131.26
- Y 141.26
- Y 151.26
- Y 161.26

Types and Dimensions

Bottom Non Perforated

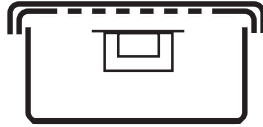

Bottom Perforated

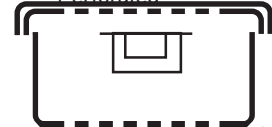

580 x 280 x 100 mm



- Y 112.10
- Y 122.10
- Y 132.10
- Y 142.10
- Y 152.10
- Y 162.10

- Y 113.10
- Y 123.10
- Y 133.10
- Y 143.10
- Y 153.10
- Y 163.10

580 x 280 x 135 mm



- Y 112.13
- Y 122.13
- Y 132.13
- Y 142.13
- Y 152.13
- Y 162.13

- Y 113.13
- Y 123.13
- Y 133.13
- Y 143.13
- Y 153.13
- Y 163.13

580 x 280 x 150 mm



- Y 112.15
- Y 122.15
- Y 132.15
- Y 142.15
- Y 152.15
- Y 162.15

- Y 113.15
- Y 123.15
- Y 133.15
- Y 143.15
- Y 153.15
- Y 163.15

580 x 280 x 200 mm



- Y 112.20
- Y 122.20
- Y 132.20
- Y 142.20
- Y 152.20
- Y 162.20

- Y 113.20
- Y 123.20
- Y 133.20
- Y 143.20
- Y 153.20
- Y 163.20

580 x 280 x 260 mm



- Y 112.26
- Y 122.26
- Y 132.26
- Y 142.26
- Y 152.26
- Y 162.26

- Y 113.26
- Y 123.26
- Y 133.26
- Y 143.26
- Y 153.26
- Y 163.26

bottoms and lids

Types and Dimensions

Bottom Non Perforated



Bottom Perforated

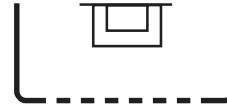

- 580 x 280 x 100 mm **Y 105.10**
- 580 x 280 x 135 mm **Y 105.13**
- 580 x 280 x 150 mm **Y 105.15**
- 580 x 280 x 200 mm **Y 105.20**
- 580 x 280 x 260 mm **Y 105.26**



- 580 x 280 x 100 mm **Y 106.10**
- 580 x 280 x 135 mm **Y 106.13**
- 580 x 280 x 150 mm **Y 106.15**
- 580 x 280 x 200 mm **Y 106.20**
- 580 x 280 x 260 mm **Y 106.26**

Types and Dimensions

Lid Perforated



Safety Lid



580 x 280 mm



- Y 100.01**
- Y 100.02**
- Y 100.03**
- Y 100.04**
- Y 100.05**
- Y 100.06**

580 x 280 mm



- Y 103.01**
- Y 103.02**
- Y 103.03**
- Y 103.04**
- Y 103.05**
- Y 103.06**

accessories

Special Accessories

Wire Baskets



485 x 255 x 30 mm **Y 190.03**
 485 x 255 x 50 mm **Y 190.05**
 485 x 255 x 70 mm **Y 190.07**
 485 x 255 x 100 mm **Y 190.10**

Wire Baskets



540 x 255 x 30 mm **Y 191.03**
 540 x 255 x 50 mm **Y 191.05**
 540 x 255 x 70 mm **Y 191.07**
 540 x 255 x 100 mm **Y 191.10**

Special Accessories

Wire Base



545 x 255 x 30 mm **Y 193.00**

Drape Retainer



545 x 255 mm **Y 195.00**

Drape

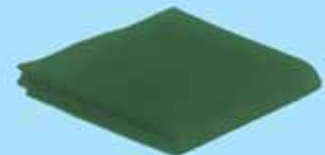

130 x 60 cm **Y 095.07**
 140 x 100 cm **Y 095.08**
 185 x 45 cm **Y 095.09**
 185 x 60 cm **Y 095.10**

Types and Dimensions

Bottom Non Perforated



Bottom Perforated



465 x 280 x 100 mm



- Y 210.10
- Y 220.10
- Y 230.10
- Y 240.10
- Y 250.10
- Y 260.10

- Y 211.10
- Y 221.10
- Y 231.10
- Y 241.10
- Y 251.10
- Y 261.10

465 x 280 x 135 mm



- Y 210.13
- Y 220.13
- Y 230.13
- Y 240.13
- Y 250.13
- Y 260.13

- Y 211.13
- Y 221.13
- Y 231.13
- Y 241.13
- Y 251.13
- Y 261.13

465 x 280 x 150 mm



- Y 210.15
- Y 220.15
- Y 230.15
- Y 240.15
- Y 250.15
- Y 260.15

- Y 211.15
- Y 221.15
- Y 231.15
- Y 241.15
- Y 251.15
- Y 261.15

Types and Dimensions

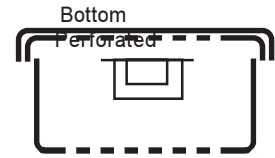
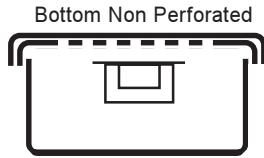

465 x 280 x 100 mm



- Y 212.10
- Y 222.10
- Y 232.10
- Y 242.10
- Y 252.10
- Y 262.10

- Y 213.10
- Y 223.10
- Y 233.10
- Y 243.10
- Y 253.10
- Y 263.10

465 x 280 x 135 mm



- Y 212.13
- Y 222.13
- Y 232.13
- Y 242.13
- Y 252.13
- Y 262.13

- Y 213.13
- Y 223.13
- Y 233.13
- Y 243.13
- Y 253.13
- Y 263.13

465 x 280 x 150 mm



- Y 212.15
- Y 222.15
- Y 232.15
- Y 242.15
- Y 252.15
- Y 262.15

- Y 213.15
- Y 223.15
- Y 233.15
- Y 243.15
- Y 253.15
- Y 263.15

bottoms and lids

Types and Dimensions

Bottom Non Perforated



Bottom Perforated

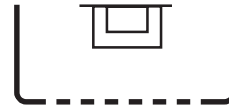

465 x 280 x 100 mm **Y 205.10**
 465 x 280 x 135 mm **Y 205.13**
 465 x 280 x 150 mm **Y 205.15**



465 x 280 x 100 mm **Y 206.10**
 465 x 280 x 135 mm **Y 206.13**
 465 x 280 x 150 mm **Y 206.15**

Types and Dimensions

Lid Perforated



Safety Lid



465 x 280 mm

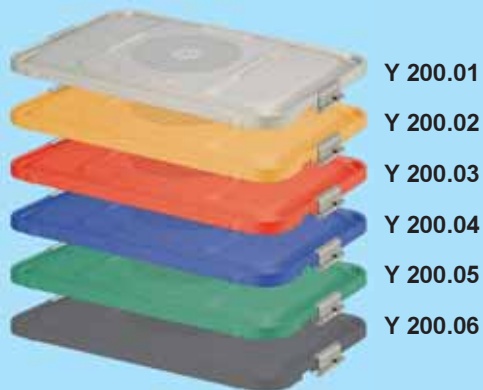

Y 200.01
Y 200.02
Y 200.03
Y 200.04
Y 200.05
Y 200.06

465 x 280 mm



Y 203.01
Y 203.02
Y 203.03
Y 203.04
Y 203.05
Y 203.06

Special Accessories

Wire Baskets



405 x 255 x 30 mm **Y 290.03**
405 x 255 x 50 mm **Y 290.05**
405 x 255 x 70 mm **Y 290.07**
405 x 255 x 100 mm **Y 290.10**

Wire Base



405 x 255 x 30 mm **Y 293.03**

Special Accessories

Drape Retainer



405 x 255 mm **Y 295.00**

Drape

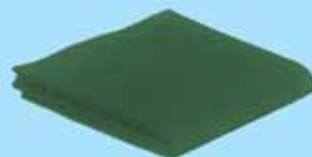

140 x 100 cm **Y 095.08**

Types and Dimensions

Bottom Non Perforated



Bottom Perforated



285 x 280 x 100 mm



- Y 310.10
- Y 320.10
- Y 330.10
- Y 340.10
- Y 350.10
- Y 360.10

- Y 311.10
- Y 321.10
- Y 331.10
- Y 341.10
- Y 351.10
- Y 361.10

285 x 280 x 135 mm



- Y 310.13
- Y 320.13
- Y 330.13
- Y 340.13
- Y 350.13
- Y 360.13

- Y 311.13
- Y 321.13
- Y 331.13
- Y 341.13
- Y 351.13
- Y 361.13

285 x 280 x 150 mm



- Y 310.15
- Y 320.15
- Y 330.15
- Y 340.15
- Y 350.15
- Y 360.15

- Y 311.15
- Y 321.15
- Y 331.15
- Y 341.15
- Y 351.15
- Y 361.15

285 x 280 x 200 mm



- Y 310.20
- Y 320.20
- Y 330.20
- Y 340.20
- Y 350.20
- Y 360.20

- Y 311.20
- Y 321.20
- Y 331.20
- Y 341.20
- Y 351.20
- Y 361.20

285 x 280 x 260 mm



- Y 310.26
- Y 320.26
- Y 330.26
- Y 340.26
- Y 350.26
- Y 360.26

- Y 311.26
- Y 321.26
- Y 331.26
- Y 341.26
- Y 351.26
- Y 361.26

Types and Dimensions

Bottom Non Perforated

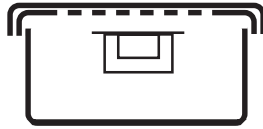

Bottom Perforated

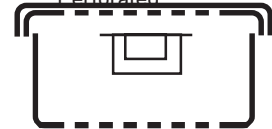

285 x 280 x 100 mm



- Y 312.10
- Y 322.10
- Y 332.10
- Y 342.10
- Y 352.10
- Y 362.10

- Y 313.10
- Y 323.10
- Y 333.10
- Y 343.10
- Y 353.10
- Y 363.10

285 x 280 x 135 mm



- Y 312.13
- Y 322.13
- Y 332.13
- Y 342.13
- Y 352.13
- Y 362.13

- Y 313.13
- Y 323.13
- Y 333.13
- Y 343.13
- Y 353.13
- Y 363.13

285 x 280 x 150 mm



- Y 312.15
- Y 322.15
- Y 332.15
- Y 342.15
- Y 352.15
- Y 362.15

- Y 313.15
- Y 323.15
- Y 333.15
- Y 343.15
- Y 353.15
- Y 363.15

285 x 280 x 200 mm



- Y 312.20
- Y 322.20
- Y 332.20
- Y 342.20
- Y 352.20
- Y 362.20

- Y 313.20
- Y 323.20
- Y 333.20
- Y 343.20
- Y 353.20
- Y 363.20

285 x 280 x 260 mm



- Y 312.26
- Y 322.26
- Y 332.26
- Y 342.26
- Y 352.26
- Y 362.26

- Y 313.26
- Y 323.26
- Y 333.26
- Y 343.26
- Y 353.26
- Y 363.26

bottoms and lids

Types and Dimensions

Bottom Non Perforated



- 285 x 280 x 100 mm **Y 305.10**
- 285 x 280 x 135 mm **Y 305.13**
- 285 x 280 x 150 mm **Y 305.15**
- 285x 280 x 200 mm **Y 305.20**
- 285 x 280 x 260 mm **Y 305.26**

Bottom Perforated

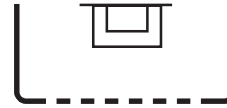

- 285 x 280 x 100 mm **Y 306.10**
- 285 x 280 x 135 mm **Y 306.13**
- 285 x 280 x 150 mm **Y 306.15**
- 285 x 280 x 200 mm **Y 306.20**
- 285 x 280 x 260 mm **Y 306.26**

Types and Dimensions

Lid Perforated



285x 280 mm



- Y 300.01**
- Y 300.02**
- Y 300.03**
- Y 300.04**
- Y 300.05**
- Y 300.06**

Safety Lid



285 x 280 mm



- Y 303.01**
- Y 303.02**
- Y 303.03**
- Y 303.04**
- Y 303.05**
- Y 303.06**

Special Accessories

Wire Baskets



255 x 245 x 30 mm **Y 390.03**
255 x 245 x 50 mm **Y 390.05**
255 x 245 x 70 mm **Y 390.07**
255 x 245 x 100 mm **Y 390.10**

Wire Base



258 x 258 x 30 mm **Y 393.00**

Special Accessories

Drape Retainer



255 x 255 mm **Y 395.00**

Drape

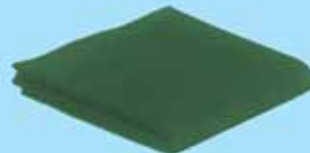

90 x 60 cm **Y 095.04**
90 x 80 cm **Y 095.05**
130 x 45 cm **Y 095.06**
130 x 60 cm **Y 095.07**

Types and Dimensions

Bottom Non Perforated

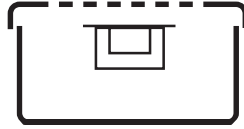

Bottom Perforated

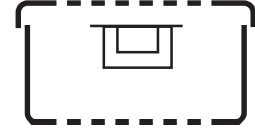

285 x 280 x 55 mm



-  Y 310.05
-  Y 320.05
-  Y 330.05
-  Y 340.05
-  Y 350.05

285x 280 x 85 mm



-  Y 310.08
-  Y 320.08
-  Y 330.08
-  Y 340.08
-  Y 350.08

-  Y 311.08
-  Y 321.08
-  Y 331.08
-  Y 341.08
-  Y 351.08

bottoms,lids and accessories

Types and Dimensions

Bottom Non Perforated



Bottom Perforated

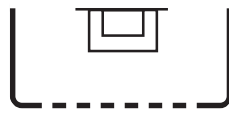

Lid Perforated



285 x 280 x 55 mm **Y 305.05**
 285 x 280 x 85 mm **Y 305.08**



285 x 280 x 85 mm **Y 306.08**



Y 304.01
Y 304.02
Y 304.03
Y 304.04
Y 304.05

Special Accessories

Wire Baskets



255 x 245 x 30 mm **Y 390.03**
 255 x 245 x 50 mm **Y 390.05**

Wire Base



258 x 258 x 30 mm **Y 393.00**

Silicon Mat



245 x 245 mm **Y 851.00**

Drape Retainer



255 x 255 mm **Y 395.00**

Drape



90 x 60 cm **Y 095.04**
 90 x 80 cm **Y 095.05**

Types and Dimensions

Bottom Non Perforated



Bottom Perforated

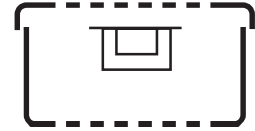

300 x 140 x 40 mm



- Y 410.04
- Y 420.04
- Y 430.04
- Y 440.04
- Y 450.04

- Y 411.04
- Y 421.04
- Y 431.04
- Y 441.04
- Y 451.04

300 x 140 x 70 mm



- Y 410.07
- Y 420.07
- Y 430.07
- Y 440.07
- Y 450.07

- Y 411.07
- Y 421.07
- Y 431.07
- Y 441.07
- Y 451.07

300 x 140 x 100 mm



- Y 410.10
- Y 420.10
- Y 430.10
- Y 440.10
- Y 450.10

- Y 411.10
- Y 421.10
- Y 431.10
- Y 441.10
- Y 451.10

bottoms, lids and accessories

Types and Dimensions

Bottom Non Perforated



Bottom Perforated

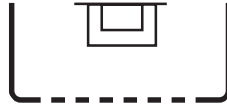

Lid Perforated



300 x 140 x 40 mm **Y 405.04**
 300 x 140 x 70 mm **Y 405.07**
 300 x 140 x 100 mm **Y 405.10**



300 x 140 x 40 mm **Y 406.04**
 300 x 140 x 70 mm **Y 406.07**
 300 x 140 x 100 mm **Y 406.10**

300 x 140 mm



Y 400.01
Y 400.02
Y 400.03
Y 400.04
Y 400.05

Special Accessories

Silicon Mat



270 x 125 mm **Y 850.00**

Drape Retainer



280 x 125 mm **Y 495.00**

Drape

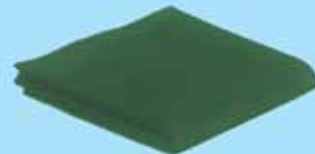

60 x 40 cm **Y 095.01**

Types and Dimensions

Lid And Bottom Perforated

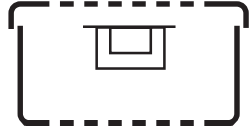

Bottom Perforated

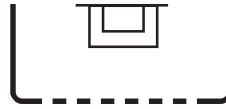

Lid Perforated



310 x 190 x 40 mm



● Y 510.04



310 x 190 x 40 mm Y 506.04

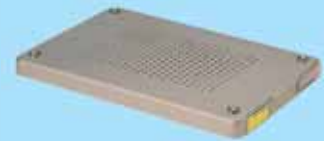

310 x 190 mm Y 500.01

310 x 190 x 65 mm



● Y 510.06



310 x 190 x 65 mm Y 506.06
310 x 190 x 130 mm Y 506.13

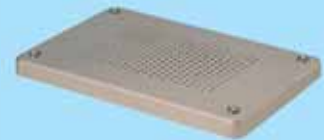

310 x 190 mm Y 500.02

310 x 190 x 130 mm



● Y 510.13

Special Accessories

Drape Retainer



310 x 190 mm Y 595.00

Drape

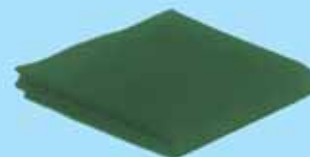

60 x 40 cm Y 095.01
65 x 65 cm Y 095.02
85 x 85 cm Y 095.03

Types and Dimensions

Lid Perforated - Bottom Perforated (Non Filter)

300 x 138 x 65 mm



- Y 610.06
- Y 620.06
- Y 630.06
- Y 640.06
- Y 650.06

500 x 155 x 75 mm



- Y 612.07
- Y 622.07
- Y 632.07
- Y 642.07
- Y 652.07

Scopy containers

Types and Dimensions

Lid Perforated - Bottom Perforated (Non Filter)

250 x 60 x 50 mm



- Y 600.01

450 x 70 x 60 mm



- Y 600.02

Types and Dimensions

Lid And Bottom Non Perforated

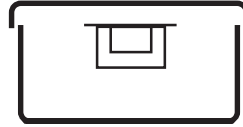

Bottom Non Perforated



285 x 280 x 100 mm



285 x 280 x 150 mm



580 x 280 x 150 mm



- Y 315.10
- Y 325.10
- Y 335.10
- Y 345.10
- Y 355.10
- Y 365.10

- Y 315.15
- Y 325.15
- Y 335.15
- Y 345.15
- Y 355.15
- Y 365.15

- Y 115.15
- Y 125.15
- Y 135.15
- Y 145.15
- Y 155.15
- Y 165.15



285 x 280 x 150 mm Y 305.10

285 x 280 x 150 mm Y 305.15



580 x 280 x 150 mm Y 105.15

Lids - Non Perforated



Lids - Non Perforated



580 x 280 mm



- Y 102.01
- Y 102.02
- Y 102.03
- Y 102.04
- Y 102.05
- Y 102.06

285 x 280 mm



- Y 302.01
- Y 302.02
- Y 302.03
- Y 302.04
- Y 302.05
- Y 302.06

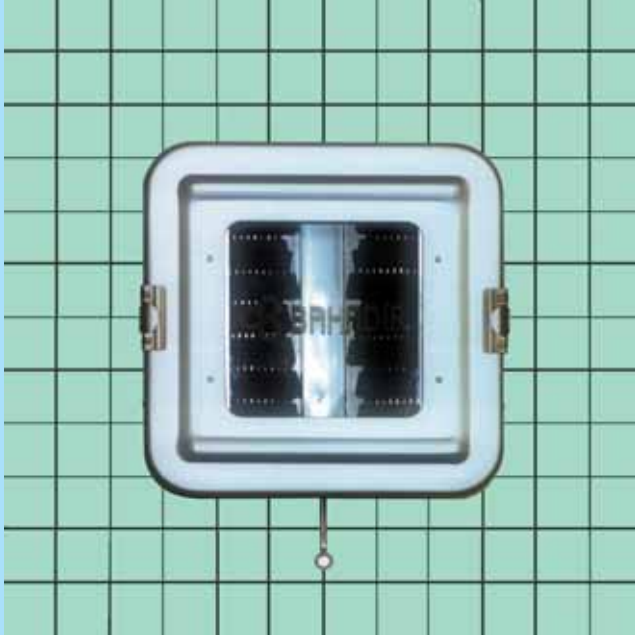

Y 880.00

Brush container. For 20 brushes
285 x 280 x 85 mm

Containers are supplied together with
mounting fixtures onto the wall.
Brushes are taken out by moving of the
handle in both directions right or left
under the container.



Y 880.00

Y 880.01

Y 880.02

Y 880.03

Y 880.04

Filters, Indicators and Labels

Disposable paper filters



Y 800.00
100 Pcs/Package
For 1/1, 3/4 and Half Size Containers

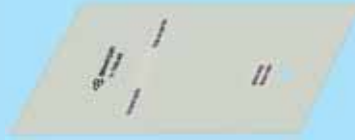

Y 802.00
100 Pcs/Package
For Mini Containers

Y 804.00
100 Pcs/Package
For Dental Containers



Y 801.00
Filter Dispanser

Textile Filters



Y 800.01
Single
For 1/1, 3/4 and Half Size Containers

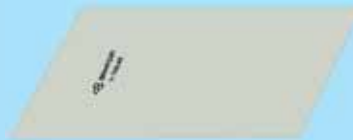

Y 802.01
Single
For Mini Containers

Y 804.01
Single
For Dental Containers



Y 809.00
For Paper Filter and For Textile Filter



Y 810.00
100 Pcs / Package
Paper label with indicator
For 1/1, 3/4 and Half Size Containers

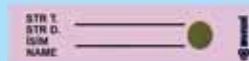

Y 812.00
100 Pcs / Package
Paper label with indicator
For Mini and Dental Containers



Y 819.00
100 Pcs / Package
Plastic Security Seal

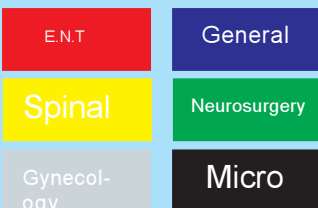

- Y 820.01
- Y 820.02
- Y 820.03
- Y 820.04
- Y 820.05
- Y 820.06

Coloured Identification Labels
Engraved to your specifications, max. 16 letters.

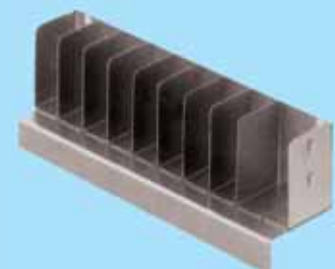

Y 829.00
Dispenser for identification labels

Components



Y 830.00
Holding Pin
For Wire Baskets

Y 830.01
Holding Pin
For Partition Sheets



Partition Sheets
Stainless Steel

Y 831.05 50 x 20 mm
Y 831.13 130 x 20 mm
Y 831.22 225 x 20 mm
Y 831.46 460 x 20 mm

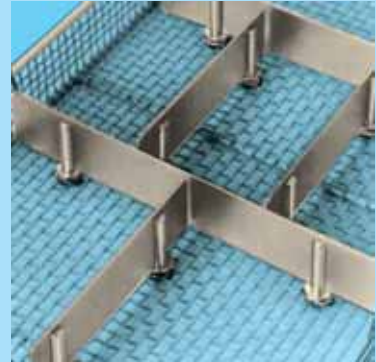

Y 840.00
Divider, to be used with Y 841.00



Y 841.00 232 mm
Y 841.01 471 mm
Sliding Rails with Securing Screws



Y 842.00 232 mm
Y 842.01 471 mm
Limiting Bar with Securing Screws



Y 845.00
Spiral Holding



Y 847.00
Double Spiral Holding



Y 849.00
Fixation Clamp



Carrying



Y 890.00
Trolley
720 x 620 x 800 mm



Y 891.00
Trolley
1030 x 620 x 1170 mm



SETS



Sayfa	Adet	Kod	Açıklama
2	2	A 202.00	PINARD Stethoscope 15.5 cm
6	1	B 030.01	Scalpel Handle 3 No 13.5 cm
7	1	B 040.01	Scalpel Handle 4 No 13.5 cm
14	1	C 440.01	MAYO Surgical Scissors 15.5 cm
14	1	C 440.02	MAYO Surgical Scissors 17 cm
25	2	D 240.03	Dissecting Forcep 16 cm
27	2	D 360.04	Tissue Forcep 16 cm
140	2	E 270.01	COLLIN-POZZI Uterine Tenaculum Forcep 25 cm
143	1	E 380.02	MUSEUX Uterine Tenaculum Forcep 24 cm
177	1	E 700.01	WINTER Placenta and Ovum Forcep 29 cm
177	1	E 700.02	WINTER Placenta and Ovum Forcep 29 cm
177	1	E 700.03	WINTER Placenta and Ovum Forcep 29 cm
177	1	E 702.01	WINTER Placenta and Ovum Forcep 29 cm
177	1	E 702.02	WINTER Placenta and Ovum Forcep 29 cm
177	1	E 702.03	WINTER Placenta and Ovum Forcep 29 cm
44	1	F 230.00	MAYO-HEGAR Needle Holder 15 cm
44	1	F 230.01	MAYO-HEGAR Needle Holder 18 cm
55	4	G 423.00	PEAN Haemostatic Forcep 13 cm
57	4	G 448.00	KOCHER- OCHSNER Haemostatic Forcep 16 cm
67	1	J 033.16	Probe Ø 2 mm 16 cm
135	1	J 652.08	SIMS Uterine Probe Malleable 33 cm
132	1	J 750.02	HEGAR Uterine Dilator 2 mm 18.5 cm
132	1	J 750.03	HEGAR Uterine Dilator 3 mm 18.5 cm
132	1	J 750.04	HEGAR Uterine Dilator 4 mm 18.5 cm
132	1	J 750.05	HEGAR Uterine Dilator 5 mm 18.5 cm
132	1	J 750.06	HEGAR Uterine Dilator 6 mm 18.5 cm
132	1	J 750.07	HEGAR Uterine Dilator 7 mm 18.5 cm
132	1	J 750.08	HEGAR Uterine Dilator 8 mm 18.5 cm
132	1	J 750.09	HEGAR Uterine Dilator 9 mm 18.5 cm
132	1	J 750.10	HEGAR Uterine Dilator 10 mm 18.5 cm
132	1	J 750.11	HEGAR Uterine Dilator 11 mm 18.5 cm
132	1	J 750.12	HEGAR Uterine Dilator 12 mm 18.5 cm
132	1	J 751.01	HEGAR Uterine Dilator 1.5 mm 18.5 cm
132	1	J 751.02	HEGAR Uterine Dilator 2.5 mm 18.5 cm
132	1	J 751.03	HEGAR Uterine Dilator 3.5 mm 18.5 cm
132	1	J 751.04	HEGAR Uterine Dilator 4.5 mm 18.5 cm
132	1	J 751.05	HEGAR Uterine Dilator 5.5 mm 18.5 cm
132	1	J 751.06	HEGAR Uterine Dilator 6.5 mm 18.5 cm
132	1	J 751.07	HEGAR Uterine Dilator 7.5 mm 18.5 cm
132	1	J 751.08	HEGAR Uterine Dilator 8.5 mm 18.5 cm
132	1	J 751.09	HEGAR Uterine Dilator 9.5 mm 18.5 cm
132	1	J 751.10	HEGAR Uterine Dilator 10.5 mm 18.5 cm
132	1	J 751.11	HEGAR Uterine Dilator 11.5 mm 18.5 cm
132	1	J 751.12	HEGAR Uterine Dilator 12.5 mm 18.5 cm
113	3	L 763.02	CUSCO Vaginal Specula 100 x 25-27 mm
112	2	L 770.01	CUSCO Vaginal Specula 75 x 17 mm
113	3	L 771.02	CUSCO Vaginal Specula 80 x 32 mm
163	1	N 520.08	RECAMIER Uterine Scoop Sharp-Rigid 7.5 mm 30 cm
163	1	N 520.09	RECAMIER Uterine Scoop Sharp-Rigid 8.5 mm 30 cm
163	1	N 520.12	RECAMIER Uterine Scoop Sharp-Rigid 10.5 mm 30 cm
163	1	N 520.15	RECAMIER Uterine Scoop Sharp-Rigid 12 mm 30 cm
163	1	N 520.19	RECAMIER Uterine Scoop Sharp-Rigid 14 mm 30 cm
212	1	Y 210.13	3/4 Size Container 465 x 280 x 135 mm Botton Non Perforated
215	1	Y 290.03	3/4 Wire Basket 405 x 255 x 30 mm
215	1	Y 290.05	3/4 Wire Basket 405 x 255 x 50 mm

Sayfa	Adet	Kod	Açıklama
2	1	A 201.00	Stethoscope Wooden 14.5 cm
6	1	B 030.01	Scalpel Handle 3 No 13.5 cm
7	1	B 040.01	Scalpel Handle 4 No 13.5 cm
14	2	C 440.01	MAYO Surgical Scissors 15.5 cm
16	1	C 456.00	MAYO-HARRINGTON Surgical Scissors Straight 23 cm
16	1	C 457.00	MAYO-HARRINGTON Surgical Scissors Curved 23 cm
25	2	D 240.03	Dissecting Forceps 16 cm
27	1	D 360.04	Tissue Forceps 16 cm
33	2	E 058.00	SIMS-MAIER Sponge and Dressing Forcep 28 cm
141	5	E 255.01	POZZI Uterine Tenaculum Forcep 25.5 cm
140	2	E 270.01	COLLIN-POZZI Uterine Tenaculum Forceps 25 cm
177	1	E 700.01	WINTER Placenta and Ovum Forcep 29 cm
177	1	E 700.02	WINTER Placenta and Ovum Forcep 29 cm
177	1	E 700.03	WINTER Placenta and Ovum Forcep 29 cm
177	1	E 702.01	WINTER Placenta and Ovum Forcep 29 cm
177	1	E 702.02	WINTER Placenta and Ovum Forcep 29 cm
177	1	E 702.03	WINTER Placenta and Ovum Forcep 29 cm
57	1	G 430.00	ROCHESTER-PEAN Haemostatic Forcep Straight 16 cm
57	1	G 430.01	ROCHESTER-PEAN Haemostatic Forcep Straight 18.5 cm
57	1	G 430.02	ROCHESTER-PEAN Haemostatic Forcep Straight 20 cm
57	1	G 431.00	ROCHESTER-PEAN Haemostatic Forcep Curved 16 cm
57	1	G 431.01	ROCHESTER-PEAN Haemostatic Forcep Curved 18.5 cm
57	1	G 431.02	ROCHESTER-PEAN Haemostatic Forcep Curved 20 cm
57	1	G 448.00	KOCHER-OCHSNER Haemostatic Forcep Straight 16 cm
57	1	G 448.01	KOCHER-OCHSNER Haemostatic Forcep Straight 18.5 cm
57	1	G 448.02	KOCHER-OCHSNER Haemostatic Forcep Straight 20 cm
57	1	G 449.00	KOCHER-OCHSNER Haemostatic Forcep Curved 16 cm
57	1	G 449.01	KOCHER-OCHSNER Haemostatic Forcep Curved 18.5 cm
57	1	G 449.02	KOCHER-OCHSNER Haemostatic Forcep Curved 20 cm
67	1	J 033.16	Probe Ø 2 mm 16 cm
167	2	J 490.00	SCHULZE Vacuum Curette Complete(j 490.01, J 490.02, J 490.03, J 490.04)
135	2	J 652.08	SIMS Uterine Probe Malleable 33 cm
132	1	J 750.01	HEGAR Uterine Dilator 1 mm 18.5 cm
132	1	J 750.02	HEGAR Uterine Dilator 2 mm 18.5 cm
132	1	J 750.03	HEGAR Uterine Dilator 3 mm 18.5 cm
132	1	J 750.04	HEGAR Uterine Dilator 4 mm 18.5 cm
132	1	J 750.05	HEGAR Uterine Dilator 5 mm 18.5 cm
132	1	J 750.06	HEGAR Uterine Dilator 6 mm 18.5 cm
132	1	J 750.07	HEGAR Uterine Dilator 7 mm 18.5 cm
132	1	J 750.08	HEGAR Uterine Dilator 8 mm 18.5 cm
132	1	J 750.09	HEGAR Uterine Dilator 9 mm 18.5 cm
132	1	J 750.10	HEGAR Uterine Dilator 10 mm 18.5 cm
132	1	J 750.11	HEGAR Uterine Dilator 11 mm 18.5 cm
132	1	J 750.12	HEGAR Uterine Dilator 12 mm 18.5 cm
132	1	J 750.13	HEGAR Uterine Dilator 13 mm 18.5 cm
132	1	J 751.01	HEGAR Uterine Dilator 1.5 mm 18.5 cm
132	1	J 751.02	HEGAR Uterine Dilator 2.5 mm 18.5 cm
132	1	J 751.03	HEGAR Uterine Dilator 3.5 mm 18.5 cm
132	1	J 751.04	HEGAR Uterine Dilator 4.5 mm 18.5 cm
132	1	J 751.05	HEGAR Uterine Dilator 5.5 mm 18.5 cm
132	1	J 751.06	HEGAR Uterine Dilator 6.5 mm 18.5 cm
132	1	J 751.07	HEGAR Uterine Dilator 7.5 mm 18.5 cm
132	1	J 751.08	HEGAR Uterine Dilator 8.5 mm 18.5 cm
132	1	J 751.09	HEGAR Uterine Dilator 9.5 mm 18.5 cm
132	1	J 751.10	HEGAR Uterine Dilator 10.5 mm 18.5 cm
132	1	J 751.11	HEGAR Uterine Dilator 11.5 mm 18.5 cm
132	1	J 751.12	HEGAR Uterine Dilator 12.5 mm 18.5 cm
132	1	J 751.13	HEGAR Uterine Dilator 13.5 mm 18.5 cm

Sayfa	Adet	Kod	Açıklama
112	2	L 754.02	COLLIN Vaginal Spekula 100/90 mm 32 mm
113	2	L 763.03	CUSCO Vaginal Spekula 110 x 27-30 mm
113	5	L 765.02	CUSCO Vaginal Spekula 90 x 37 mm
115	3	L 785.02	TRELAT Vaginal Spekula 95 x 35 mm
163	1	N 520.08	RECAMIER Uterine Scoop Sharp-Rigid 7.5 mm 30 cm
163	1	N 520.09	RECAMIER Uterine Scoop Sharp-Rigid 8.5 mm 30 cm
163	1	N 520.12	RECAMIER Uterine Scoop Sharp-Rigid 10.5 mm 30 cm
163	1	N 520.15	RECAMIER Uterine Scoop Sharp-Rigid 12 mm 30 cm
163	1	N 520.19	RECAMIER Uterine Scoop Sharp-Rigid 14 mm 30 cm
163	1	N 520.21	RECAMIER Uterine Scoop Sharp-Rigid 15 mm 30 cm
163	1	N 520.24	RECAMIER Uterine Scoop Sharp-Rigid 16.5 mm 30 cm
163	1	N 520.27	RECAMIER Uterine Scoop Sharp-Rigid 18 mm 30 cm
163	1	N 520.30	RECAMIER Uterine Scoop Sharp-Rigid 19.5 mm 30 cm
163	1	N 520.34	RECAMIER Uterine Scoop Sharp-Rigid 21.5 mm 30 cm
163	1	N 520.38	RECAMIER Uterine Scoop Sharp-Rigid 23.5 mm 30 cm
157	1	R 715.01	SCHUMACHER Biopsy Forcep 24 cm
157	1	R 715.02	SCHUMACHER Biopsy Forcep 24 cm
208	1	Y 110.15	1/1 Size Container Basic Model 580 x 280 x 150 mm
211	1	Y 190.03	1/1 Wire Basket 540 x 255 x 30 mm
211	1	Y 190.07	1/1 Wire Basket 540 x 255 x 70 mm

Sayfa	Adet	Kod	Açıklama
9	1	C 312.04	Surgical Scissors Straight 15 cm
16	1	C 456.00	MAYO-HARRINGTONN Surgical Scissors Straight 23 cm
20	1	C 491.00	SIEBOLD Deep Operation Scissors 24.5 cm
25	2	D 240.03	Dissecting Forcep 16 cm
27	2	D 360.04	Tissue Forcep 16 cm
32	1	E 050.00	MAIER Dressing Forceps Straight 26.5 cm
32	1	E 051.00	MAIER Dressing Forceps Curved 26.5 cm
148	2	E 130.01	Plypus and Ovum Forceps
44	2	F 230.01	MAYO-HEGAR Needle Holder 18 cm
57	2	G 430.01	ROCHESTER-PEAN Haemostatic Forcep Straight 18.5 cm
57	2	G 431.01	ROCHESTER-PEAN Haemostatic Forcep Curved 18.5 cm
57	1	G 448.01	ROCHESTER-PEAN Haemostatic Forcep Straight 18.5 cm
57	1	G 449.01	ROCHESTER-PEAN Haemostatic Forcep Curved 18.5 cm
120	1	K 819.03	JACKSON Vaginal Specula 17.5 cm 89 x 38 mm
120	1	K 819.04	JACKSON Vaginal Specula 17.5 cm 102 x 38 mm
216	1	Y 310.10	1/2 Size Container Bottom Non Perforated 285 x 280 x 100 mm
219	1	Y 390.05	1/2 Wire Basket 255 x 245 x 50 mm

Sayfa	Adet	Kod	Açıklama
171	1	C 612.02	DUBOIS Scissors For Obstetric Straight 27.5 cm
171	1	C 613.02	DUBOIS Scissors For Obstetric Curved 27.5 cm
172	1	E 557.02	NAGELE Obstetrical Forcep 35.5 cm
173	1	E 565.02	KIELLAND Obstetrical Forcep 42 cm
173	1	E 567.02	PIPER Obstetrical Forcep 44.5 cm
176	1	E 598.02	GAUSS Obstetrical Forcep 26 cm
179	1	T 430.01	SIMELLE Placenda and Ovum Forcep27 cm
179	1	T 436.01	TARNIEER Placenda and Ovum Forcep44 cm
179	1	T 440.02	BRAUN Placenda and Ovum Forcep 42 cm
212	1	Y 210.10	3/4 Size Container 465 x 280 x 100 mm Botton Non Perforated
215	1	Y 290.05	3/4 Wire Basket 405 x 255 x 50 mm

Sayfa	Adet	Kod	Açıklama
6	2	B 030.02	Scalpel Handle 3 No 21.5 cm
7	2	B 040.01	Scalpel Handle 4 No 13.5 cm
7	2	B 040.02	Scalpel Handle 3 No 21.5 cm
9	2	C 312.03	Surgical Scissors Straight/Blunt 14.5 cm
11	3	C 313.03	COOPER Surgical Scissors Curved/Blunt 14.5 cm
12	2	C 416.00	TOENNIS-ADSON Dissecting Scissors 17.5 cm
20	1	C 491.00	SIEBOLD Deep Operation Scissors 24.5 cm
24	2	D 225.02	Dissecting Forcep Straight 14.5 cm
25	1	D 240.05	Dissecting Forcep Straight 20 cm
27	2	D 360.03	Tissue Forcep Straight 14.5 cm
27	2	D 361.01	Tissue Forcep Delicate 13 cm
27	2	D 361.03	Tissue Forcep Delicate 16 cm
32	1	E 050.00	MAIER Sponge and Dressing Forcep Straight 26.5 cm
32	1	E 051.00	MAIER Sponge and Dressing Forcep Curved 26.5 cm
36	2	E 150.00	ALLIS Dressing-Organ and Tissue Forcep 15.5 cm
141	2	E 255.01	POZZI Uterine Tenaculum Forcep 25.5 cm
41	8	E 430.01	BACKHAUS Towel Clamp 11 cm
177	2	E 700.01	WINTER Placenta and Ovum Forcep 29 cm
177	2	E 700.02	WINTER Placenta and Ovum Forcep 29 cm
177	2	E 700.03	WINTER Placenta and Ovum Forcep 29 cm
177	2	E 702.01	WINTER Placenta and Ovum Forcep 29 cm
177	2	E 702.02	WINTER Placenta and Ovum Forcep 29 cm
177	2	E 702.03	WINTER Placenta and Ovum Forcep 29 cm
43	2	F 210.00	BAUMGARTNER Needle Holder 14.5 cm
44	1	F 231.01	HEGAR Needle Holder 15 cm
47	2	F 373.00	HEANEY Needle Holder 20 cm
134	1	J 095.12	Endospecula Charr 12 16 cm
134	1	J 095.16	Endospecula Charr 16 16 cm
135	1	J 653.05	Uterine Probe 30 cm
132	1	J 750.01	HEGAR Uterine Dilator 1 mm 18.5 cm
132	1	J 750.02	HEGAR Uterine Dilator 2 mm 18.5 cm
132	1	J 750.03	HEGAR Uterine Dilator 3 mm 18.5 cm
132	1	J 750.04	HEGAR Uterine Dilator 4 mm 18.5 cm
132	1	J 750.05	HEGAR Uterine Dilator 5 mm 18.5 cm
132	1	J 750.06	HEGAR Uterine Dilator 6 mm 18.5 cm
132	1	J 750.07	HEGAR Uterine Dilator 7 mm 18.5 cm
132	1	J 750.08	HEGAR Uterine Dilator 8 mm 18.5 cm
132	1	J 750.09	HEGAR Uterine Dilator 9 mm 18.5 cm
132	1	J 750.10	HEGAR Uterine Dilator 10 mm 18.5 cm
132	1	J 750.11	HEGAR Uterine Dilator 11 mm 18.5 cm
132	1	J 750.12	HEGAR Uterine Dilator 12 mm 18.5 cm
132	1	J 750.13	HEGAR Uterine Dilator 13 mm 18.5 cm
132	1	J 751.01	HEGAR Uterine Dilator 1.5 mm 18.5 cm
132	1	J 751.02	HEGAR Uterine Dilator 2.5 mm 18.5 cm
132	1	J 751.03	HEGAR Uterine Dilator 3.5 mm 18.5 cm
132	1	J 751.04	HEGAR Uterine Dilator 4.5 mm 18.5 cm
132	1	J 751.05	HEGAR Uterine Dilator 5.5 mm 18.5 cm
132	1	J 751.06	HEGAR Uterine Dilator 6.5 mm 18.5 cm
132	1	J 751.07	HEGAR Uterine Dilator 7.5 mm 18.5 cm
132	1	J 751.08	HEGAR Uterine Dilator 8.5 mm 18.5 cm
132	1	J 751.09	HEGAR Uterine Dilator 9.5 mm 18.5 cm
132	1	J 751.10	HEGAR Uterine Dilator 10.5 mm 18.5 cm
132	1	J 751.11	HEGAR Uterine Dilator 11.5 mm 18.5 cm
132	1	J 751.12	HEGAR Uterine Dilator 12.5 mm 18.5 cm
132	1	J 751.13	HEGAR Uterine Dilator 13.5 mm 18.5 cm

Sayfa	Adet	Kod	Açıklama
127	2	K 610.01	TUBINGER Vaginal Retractor 95x20 mm 26.5 cm
128	1	K 863.01	AUVAR Vaginal Retractor 75x42 mm 23 cm
115	1	L 785.02	TRELAT Vaginal Specula 95x35 mm
163	1	N 520.08	RECAMIER Uterine Scoop Sharp-Rigid 7.5 mm 30 cm
163	1	N 520.09	RECAMIER Uterine Scoop Sharp-Rigid 8.5 mm 30 cm
163	1	N 520.12	RECAMIER Uterine Scoop Sharp-Rigid 10.5 mm 30 cm
163	1	N 520.15	RECAMIER Uterine Scoop Sharp-Rigid 12 mm 30 cm
163	1	N 520.19	RECAMIER Uterine Scoop Sharp-Rigid 14 mm 30 cm
163	1	N 520.21	RECAMIER Uterine Scoop Sharp-Rigid 15 mm 30 cm
163	1	N 520.24	RECAMIER Uterine Scoop Sharp-Rigid 16.5 mm 30 cm
163	1	N 520.27	RECAMIER Uterine Scoop Sharp-Rigid 18 mm 30 cm
208	1	Y 110.15	1/1 Size Container Basic Model 580 x 280 x 150 mm
211	1	Y 190.05	1/1 Wire Basket 540 x 255 x 50 mm
211	1	Y 190.07	1/1 Wire Basket 540 x 255 x 70 mm

Sayfa	Adet	Kod	Açıklama
6	2	B 030.01	Scalpel Handle 3 No, 13.5 cm
6	2	B 030.02	Scalpel Handle 3 No, 21.5 cm
7	2	B 040.01	Scalpel Handle 3 No, 13.5 cm
7	2	B 040.02	Scalpel Handle 3 No, 21.5 cm
9	2	C 312.03	Surgical Scissors Straight 14.5 cm
11	2	C 313.03	Surgical Scissors Curved 14.5 cm
12	1	C 416.00	TOENNIS-ADSON Dissecting Scissors 17.5 cm
25	2	D 225.02	Dissecting Forcep 14.5 cm
25	2	D 240.05	Dissecting Forcep 20 cm
27	2	D 360.03	Tissue Forcep 14.5 cm
32	1	E 050.00	MAIER Dressing Forcep Straight 26.5 cm
32	1	E 051.00	MAIER Dressing Forcep Curved 26.5 cm
35	4	E 089.00	HEYWOOD-SMITH Forcep 21.5 cm
36	2	E 150.00	ALLIS Dressing Forcep 15.5 cm
37	2	E 159.00	ALLIS Forcep 22 cm
41	8	E 430.01	BACKHAUS Towel Clamps 11 cm
43	2	F 210.00	BAUMGARTNER Needle Holder 14.5 cm
44	2	F 231.01	HEGAR Needle Holder Curved 14.5 cm
55	5	G 420.00	PEAN Haemostatic Forcep Straight 13 cm
55	5	G 421.00	PEAN Haemostatic Forcep Curved 13 cm
54	2	G 439.00	ROCHESTER-OCHSNEN Haemostatic Forcep 14 cm
56	2	G 445.00	KOCHER Haemostatic Forcep Curved 14 cm
60	2	G 722.00	HEANEY Hysterectomy Forcep Curved 20.5 cm
69	1	K 311.00	FARABEUF Retractor 15 cm
69	2	K 315.00	BABY-ROUX Retractor 13.5 cm
74	1	K 460.04	KOCHER Retractor 23 cm
74	1	K 461.02	SAUERBRUCH Retractor 22.5 cm
87	1	K 715.04	FRITSH Abdominal Retractor 24 cm
89	1	K 764.00	REVERDIN Spatulas 28.5 cm
95	2	L 532.01	BALFOUR Abdominal Retractor (With L 580.23)
95	2	L 580.30	BALFOUR Abdominal Retractor Center Blade 540 x 80 mm
216	1	Y 310.13	1/2 Size Container Bottom Non Perforated 285 x 280 x 135 mm
219	1	Y 390.07	1/2 Wire Basket 255 x 245 x 50 mm

Sayfa	Adet	Kod	Açıklama
6	2	B 030.01	Scalpel Handle 3 No, 13.5 cm
6	2	B 030.02	Scalpel Handle 3 No, 21.5 cm
7	2	B 040.01	Scalpel Handle 3 No, 13.5 cm
7	2	B 040.02	Scalpel Handle 3 No, 21.5 cm
9	2	C 312.03	Surgical Scissors Straight 14.5 cm
11	2	C 313.03	Surgical Scissors Curved 14.5 cm
12	2	C 416.00	TOENNIS-ADSON Dissecting Scissors 17.5 cm
20	1	C 491.00	SIEBOLD Deep Operation Scissors 24.5 cm
25	2	D 225.02	Dissecting Forcep 14.5 cm
25	4	D 240.05	Dissecting Forcep 20 cm
27	2	D 360.03	Tissue Forcep 14.5 cm
32	1	E 050.00	MAIER Dressing Forcep Straight 26.5 cm
32	1	E 051.00	MAIER Dressing Forcep Curved 26.5 cm
36	2	E 150.00	ALLIS Diressing Forcep 15.5 cm
37	2	E 159.00	ALLIS Forcep 22 cm
38	1	E 174.01	BABCOOK Organ and Tissue Grasping Forceps 21.5 cm
35	2	E 190.00	HEYWOOD-SMITH Dressing Forcep 20 cm
41	8	E 430.01	BACKHAUS Towel Clamp 11 cm
43	2	F 210.00	BAUMGARTNER Needle Holder 14.5 cm
44	2	F 231.01	HEGAR Needle Holder Curved 14.5 cm
54	2	Ğ 235.00	KELLY Delicate Haemostatic Forcep Curved 14 cm
55	6	G 420.00	PEAN Haemostatic Forcep Straight 13 cm
55	6	G 421.00	PEAN Haemostatic Forcep Curved 13 cm
56	4	G 439.00	ROCHESTER-OCHSNER Haemostatic Forcep 14 cm
56	4	G 445.00	KOCHER Haemostatic Forcep Curved 14 cm
57	2	G 448.02	KOCHER-OCHSNER Haemostatic Forcep Straight 20 cm
57	2	G 449.02	KOCHER-OCHSNER Haemostatic Forcep Curved 20 cm
59	2	G 701.00	FAURE Peritoneum Forcep Curved 20.5 cm
60	4	G 722.00	HEANEY Hysterektomy Forcep Curved 20.5 cm
69	1	K 311.00	FARABEUF Retractor 15 cm
69	2	K 315.00	BABY-ROUX Retractor 13.5 cm
79	1	K 460.04	KOCHER Retractor 23 cm
74	1	K 461.02	SAUERBRUCH Retractor 22.5 cm
86	1	K 710.00	DOYEN Abdominal Retractor 26 cm
89	1	K 764.00	REVERDIN Spatulas 28.5 cm
152	1	T 420.00	DOYEN Myoma Instrument 15 cm
216	1	Y 310.13	1/2 Size Container Bottom Non Perforated 285 x 280 x 135 mm
219	1	Y 390.07	1/2 Wire Basket 255 x 245 x 50 mm

Sayfa	Adet	Kod	Açıklama
6	2	B 030.01	Scalpel Handle 3 No 13.5 cm
52	4	G 023.00	DIEFFENBACH Bulldog Clamp 6 cm
52	4	G 024.04	JOHNS-HOPKINS Bulldog Clamp 6 cm
55	6	G 420.00	PEAN Haemostatic Forcep Straight 13 cm
55	6	G 421.00	PEAN Haemostatic Forcep Curved 13 cm
56	6	G 439.00	ROCHESTER-OCHSNER Haemostatic Forcep Curved 14 cm
56	6	G 445.00	KOCHER Haemostatic Forcep Curved 15 cm
57	4	G 448.02	ROCHESTER-OCHSNER Haemostatic Forcep Straight 20 cm
57	4	G 449.02	ROCHESTER-OCHSNER Haemostatic Forcep Curved 20 cm
59	2	G 701.00	FAURE Peritoneum Forcep Curved 20.5 cm
60	4	G 722.00	HEANEY Hysterectomy Forcep Curved 20.5 cm
154	2	N 581.02	NOVAK-SCHOECKAERT Biopsy Curette 24 cm
156	1	R 710.01	FAURE Biopsy Forcep 21 cm
156	2	R 710.03	FAURE Biopsy Forcep 24 cm
216	1	Y 310.10	1/2 Size Container Bottom Non Perforated 285 x 280 x 100 mm
219	1	Y 390.05	1/2 Wire Basket 255 x 245 x 50 mm

Sayfa	Adet	Kod	Açıklama
6	1	B 030.01	Scalpel Handle 3 No 13.5 cm
6	1	B 030.02	Scalpel Handle 3 No 21.5 cm
13	1	C 420.01	METZENBAUM Dissecting Scissors 18 cm
14	1	C 440.02	MAYO Surgical Scissors Straight 17 cm
14	1	C 441.02	MAYO Surgical Scissors Curved 17 cm
25	1	D 240.05	Dissecting Forcep Straight 20 cm
27	1	D 360.06	Tissue Forcep Straight 20 cm
35	2	E 086.00	FOERSTER-BALLENGER Dressing-Organ and Tissue Forcep 24 cm
37	3	E 158.00	ALLIS-THOMAS Organ and Tissue Grasping Forcep 4x7 Teeth 20 cm
139	1	E 365.02	BOZEMANN Uterine Forcep 25 cm
41	4	E 430.02	BACKHAUS Towel Clamp 13.5 cm
46	1	F 363.02	FINOCHETTO Needle Holder 26.5 cm
53	4	G 215.00	HALSTED-MOSQUITO Delicate Haemostatic Forcep Curved 12.5 cm
57	3	G 430.02	ROCHESTER-PEAN Haemostatic Forcep Straight 20 cm
127	2	K 614.01	SIMON Vaginal Retractor 115x22 mm 27.5 cm
122	1	K 832.01	SIMS Vaginal Specula 70x25/75x30 mm 12.5 cm
122	1	K 832.05	SIMS Vaginal Specula 75x30/180x35 mm 15 cm
122	1	K 832.08	SIMS Vaginal Specula 80x36/90x40 mm 17.5 cm
128	1	K 863.01	SIMS Vaginal Specula 75x42-40 mm 1470 gr. 23 cm
216	1	Y 310.15	1/2 Size Container Bottom Non Perforated 285 x 280 x 150 mm
219	1	Y 390.07	1/2 Wire Basket 255 x 245 x 50 mm

Sayfa	Adet	Kod	Açıklama
6	1	B 030.01	Scalpel Handle 3 No 13.5 cm
6	1	B 030.02	Scalpel Handle 3 No 21.5 cm
13	1	C 421.01	METZENBAUM Dissecting Scissors Curved 18 cm
13	1	C 423.00	NELSON-METZENBAUM Dissecting Scissors Curved 23 cm
14	1	C 440.01	MAYO Surgical Scissors Straight 15.5 cm
14	1	C 441.01	MAYO Surgical Scissors Curved 15.5 cm
25	2	D 240.02	Dissecting Forcep 14.5 cm
25	2	D 240.05	Dissecting Forcep 20 cm
27	2	D 360.03	Tissue Forcep 14.5 cm
35	2	E 086.00	FOERSTER-BALLENGER Dressing Organ and Tissue Forcep 24 cm
36	6	E 144.00	ALLIS Dressing Organ and Tissue Forcep 5x6 Teeth 15.5 cm
144	2	E 201.00	Uterine Tenaculum Forcep 9 mm 15.5 cm
141	1	E 251.00	SCHRÖDER Uterine Tenaculum Forcep 25 cm
140	1	E 258.01	BRAUN Uterine Tenaculum Forcep 25 cm
139	2	E 365.02	BOZEMANN Uterine Forcep Curved 25 cm
41	6	E 430.02	BACKHAUS Towel Clamp 13.5 cm
45	1	F 355.01	HEGAR-MAYO Needle Holder 18 cm
54	12	G 241.00	CRILLE Delicate Haemostatic Forcep Curved 14 cm
57	12	G 431.00	ROCHESTER-PEAN Haemostatic Forcep Curved 16 cm
57	6	G 448.02	KOCHER-OCHSNER Haemostatic Forcep Straight 20 cm
135	1	J 650.05	MAYO Uterine Probe Malleable 33 cm
127	1	K 614.02	SIMON Vaginal Retractor 115 x 26 mm 27.5 cm
78	1	K 660.01	DEAVER Retractor 18 cm
125	1	K 706.03	DOYEN Vaginal Specula 112x45 mm 23.5 cm
118	1	K 812.04	KRISTELLER Vaginal Specula 110x18 mm 21.5 cm
120	1	K 819.02	JACKSON Vaginal Specula 76x38 mm 17.5 cm
120	1	K 819.03	JACKSON Vaginal Specula 89x38 mm 17.5 cm
130	2	L 409.00	GELPI Vaginal Retractor 17.5 cm
131	1	L 418.00	O'SULLIVAN-O'CONNOR Vaginal Retractor Complete (L 418.01-L 418.03-L 418.04-L 418.05)
212	1	Y 210.13	3/4 Size Container 465 x 280 x 135 mm Botton Non Perforated
215	1	Y 290.07	3/4 Wire Basket 405 x 255 x 70 mm

Sayfa	Adet	Kod	Açıklama
13	1	C 421.01	METZENBAUM Dissecting Scissors 18 cm
14	1	C 440.02	MAYO Surgical Scissors Straight 17 cm
14	1	C 441.02	MAYO Surgical Scissors Curved 17 cm
25	2	D 240.02	Dissecting Forcep 14.5 cm
25	1	D 240.05	Dissecting Forcep 20 cm
27	2	D 360.03	Tissue Forcep Straight 14.5 cm
27	1	D 360.06	Tissue Forcep Straight 20 cm
36	4	E 144.00	ALLIS Dressing Organ and Tissue Forcep 5x6 Teeth 15.5 cm
45	1	F 355.01	HEGAR-MAYO Needle Holder 18 cm
45	1	F 355.02	HEGAR-MAYO Needle Holder 20.5 cm
54	6	G 234.00	KELLY Delicate Haemostatic Forcep Straight 14 cm
54	6	G 235.00	KELLY Delicate Haemostatic Forcep Curved 14 cm
57	12	G 431.00	ROCHESTER-PEAN Haemostatic Forcep Curved 16 cm
57	4	G 448.02	KOCHER-OCHSNER Haemostatic Forcep Straight 20 cm
130	1	L 409.00	GELPI Vaginal Retractor 17.5 cm
216	1	Y 310.10	1/2 Size Container Bottom Non Perforated 285 x 280 x 100 mm
219	1	Y 390.05	1/2 Wire Basket 255 x 245 x 50 mm

Sayfa	Adet	Kod	Açıklama
6	1	B 030.01	Scalpel Handle 3 No 13.5 cm
25	1	D 240.06	Dissecting Forcep 25 cm
27	1	D 360.03	Tissue Forcep Straight 14.5 cm
35	3	E 086.00	FOERSTER-BALLENGER Dressing Forcep 24 cm
145	1	E 216.02	SCHRÖDER Uterine Tenaculum Forcep 10 mm 25 cm
141	1	E 251.00	SCHRÖDER Uterine Tenaculum Forcep 25 cm
139	1	E 365.02	BOZEMANN Uterine Forcep 25 cm
143	1	E 376.01	JACOBS Uterine Tenaculum Forcep 21.5 cm
41	4	E 430.02	BACKHAUS Towel Clamp 13.5 cm
57	2	G 431.00	ROCHESTER-PEAN Haemostatic Forcep Curved 16 cm
57	2	G 448.01	KOCHER-OCHSNER Haemostatic Forcep Straight 18.5 cm
135	1	J 650.05	MAYO Uterine Probe Malleable 33 cm
132	1	J 790.00	Uterine Dilator Sets (J 750.04-J 750.17/Y 310.10, Y 390.05)
127	2	K 614.01	SIMON Vaginal Specula 27.5 cm
125	1	K 706.02	DOYEN Vaginal Specula 23.5 cm
118	1	K 812.04	KRISTELLER Vaginal Specula Lower Blade 21.5 cm
118	1	K 812.06	KRISTELLER Vaginal Specula Lower Blade 22.5 cm
115	1	L 790.02	GRAVE Vaginal Specula 95x30 mm
115	1	L 790.03	GRAVE Vaginal Specula 105x33 mm
162	1	N 510.12	GOURDET Uterine Scoop 12 mm 28 cm
163	1	N 525.15	RECAMIER Uterine Scoop Sharp-Malleable 12 mm 30 cm
163	1	N 528.08	RECAMIER Uterine Scoop Blunt-Rigid 7.5 mm 30 cm
163	1	N 528.09	RECAMIER Uterine Scoop Blunt-Rigid 8.5 mm 30 cm
212	1	Y 210.10	3/4 Size Container 465 x 280 x 100 mm Botton Non Perforated
215	1	Y 290.05	3/4 Wire Basket 405 x 255 x 50 mm

Sayfa	Adet	Kod	Açıklama
6	1	B 030.02	Scalpel Handle 3 No 21.5 cm
14	1	C 441.02	MAYO Surgical Scissors 17 cm
27	1	D 360.06	Tissue Forcep Straight 20 cm
154	1	N 580.02	RANDALL Biopsy Curette 24 cm
160	1	R 750.01	TISCHLER Biopsy Forcep 20 cm

Sayfa	Adet	Kod	Açıklama
53	12	G 214.00	HALSTED-MOSQUITO Delicate Haemostatic Forcep Straight 12.5 cm
53	12	G 215.00	HALSTED-MOSQUITO Delicate Haemostatic Forcep Curved 12.5 cm
57	6	G 431.00	ROCHESTER-PEAN Haemostatic Forcep Curved 16 cm

Sayfa	Adet	Kod	Açıklama
35	1	E 086.00	FOERSTER-BALLENGER Dressing Forcep 24 cm
141	2	E 251.00	SCHRÖDER Uterine Tenaculum Forcep 25 cm
139	2	E 365.02	BOZEMANN Uterine Forcep 25 cm
41	5	E 430.02	BACKHAUS Towel Clamp 13.5 cm
167	1	J 490.00	SCHULZE Vacuum Curette Complete(j 490.01, J 490.02, J 490.03, J 490.04)
135	1	J 650.05	MAYO Uterine Probe Malleable 33 cm
132	1	J 792.00	Uterine Dilators Set [(J 750.04 - J 750.17) + (J 751.04 - J 751.17) With Y 110.10 - Y 191.05]
125	1	K 706.02	DOYEN Vaginal Specula 90x45 mm 23.5 cm
113	1	L 765.02	CUSCO Vaginal Specula 90x37 mm
115	1	L 790.03	GRAVE Vaginal Specula 105x33 mm
154	1	N 580.02	RANDALL Biopsy Curettes 24 cm
208	1	Y 110.15	1/1 Size Container Basic Model 580 x 280 x 150 mm
211	1	Y 191.05	1/1 Wire Basket 540 x 255 x 50 mm
211	1	Y 191.07	1/1 Wire Basket 540 x 255 x 70 mm

Sayfa	Adet	Kod	Açıklama
5	1	A 202.00	Scalpel Handle, 3 No, 13.5 cm
9	1	C 310.03	Surgical Scissors 14.5 cm
14	1	C 440.02	MAYO Surgical Scissors 17 cm
170	1	C 600.00	Scissors for Obstetric 10.5 cm
171	1	C 604.00	BRAUN-STADLER Obstetric Scissors 20 cm
25	1	D 240.02	Dissecting Forcep 14.5 cm
25	1	D 390.01	RUSS MODELL Dissecting Forcep 20 cm
35	4	E 086.00	FOERSTER-BALLENGER Dressing Forcep 24 cm
147	1	E 122.00	KELLY Polypus and Ovum Forcep 32 cm
36	4	E 144.00	ALLIS Dressing Organ and Tissue Forcep 5x6 Teeth 15.5 cm
141	2	E 251.00	SCHRÖDER Uterine Tenaculum Forcep 25 cm
139	2	E 365.02	BOZEMANN Uterine Forcep 25 cm
168	1	E 389.02	IOWA Instrumente for Obstetric 26 cm
41	6	E 430.02	BACKHAUS Towel Clamp 13.5 cm
173	1	E 565.02	KIELLAND Obstetrical Forcep 42 cm
173	1	E 567.02	PIPER Obstetrical Forcep 44.5 cm
174	1	E 569.02	KIELLAND-LUIKARD Obstetrical Forcep 40 cm
174	1	E 572.02	MC LEAN Obstetrical Forcep 36 cm
175	1	E 578.04	TARNIER Obstetrical Forcep 40 cm
45	1	F 355.01	HEGAR-MAYO Needle Holder 18 cm
45	1	F 355.02	HEGAR-MAYO Needle Holder 20.5 cm
54	2	G 240.00	CRILLE Delicate Haemostatic Forcep Straight 14 cm
54	6	G 241.00	CRILLE Delicate Haemostatic Forcep Curved 14 cm
57	1	G 430.00	ROCHESTER-PEAN Haemostatic Forcep Straight 16 cm
57	2	G 431.00	ROCHESTER-PEAN Haemostatic Forcep Curved 16 cm
120	2	K 819.03	JACKSON Vaginal Specula 89x38 mm 17.5 cm
130	1	L 409.00	GELPI Vaginal Retractor 17.5 cm
212	1	Y 210.10	3/4 Size Container 465 x 280 x 100 mm Botton Non Perforated
215	1	Y 290.07	3/4 Wire Basket 405 x 255 x 70 mm

Sayfa	Adet	Kod	Açıklama
14	1	C 440.02	MAYO Surgical Scissors 17 cm
171	1	C 604.00	BRAUN-STADLER Obstetric Scissors 20 cm
25	1	D 240.02	Dissecting Forcep 14.5 cm
27	1	D 360.03	Tissue Forcep Straight 14.5 cm
35	2	E 087.00	FOERSTER-BALLENGER Dressing Forcep 24 cm
45	1	F 355.02	HEGAR-MAYO Needle Holder 20.5 cm
54	2	G 244.00	CRILE Delicate Haemostatic Forcep 14 cm
222	1	Y 410.04	Mini Container Button Non Perforated 300 x 140 x 40

Sayfa	Adet	Kod	Açıklama
205	1	A 908.30	Telescope Standart 30° Ø10 mm 31 cm
205	1	A 909.30	Telescope Autoclavable 30° Ø10 mm 31 cm
205	1	H 810.01	Exploratory Probe 33 cm
203	1	J 140.04	Elektrosurgical Instrument Button Elektrode
199-204	2	J 153.03	Sleeves only Ø 5.5 mm
199-204	2	J 155.03	Sleeves only Ø 11 mm
200	1	J 161.00	Interchangeable Handle With two valve 33 cm
200	1	J 171.01	Suction İfrigation Tube
200	1	J 171.06	Suction İfrigation Tube
201	1	J 952.00	COHEN Uterine Cannula
205	1	T 802.06	Reducer Instrument 11 - 5.5 mm
190	1	X 100.03	Hook Scissors Standart Curved İnsulated 5 mm
190	1	X 113.03	METZENBAUM Hook Scissors Rotation İnsulated Curved 5 mm
190	1	X 118.01	Micro Scissors Standart Curved Uninsulated 5 mm
193	1	X 174.04	COBRA Grasping Forcep Modular İnsulated Ratchet 5 mm
193	1	X 177.03	NEEDLENOSE Grasping Forcep Modular İnsulated Delicate Jaw 5 mm
199	1	X 199.02	Atromatic Grasping Forcep Standart Uninsulated-Ratchet 5 mm
192	1	X 506.03	Biopsy Forcep Standart İnsulated With Pin 5 mm
197	1	X 530.01	Grasping Forcep Standart Uninsulated 5 mm
197	1	X 536.01	Dissecting Forcep Standart Uninsulated 5 mm
197	1	X 617.02	Claw Forcep Modular Uninsulated-Ratchet 10 mm
208	1	Y 110.13	1/1 Size Container Basic Model 580 x 280 x 150 mm
211	1	Y 191.07	1/1 Wire Basket 540 x 255 x 70 mm
187	1	Z 065.00	Electrosurgical Instrument Bipolar Cord 2 mt.
202	1	Z 300.01	Bipolar Coagulation Eleckrosurgical Forcep Modular Spring İnsulated 33 cm
202	1	Z 303.01	Bipolar Coagulation Eleckrosurgical Forcep Modular Spring İnsulated 33 cm
187	1	Z 309.00	Instrument Cable for Detachable



NUMERICAL INDEX

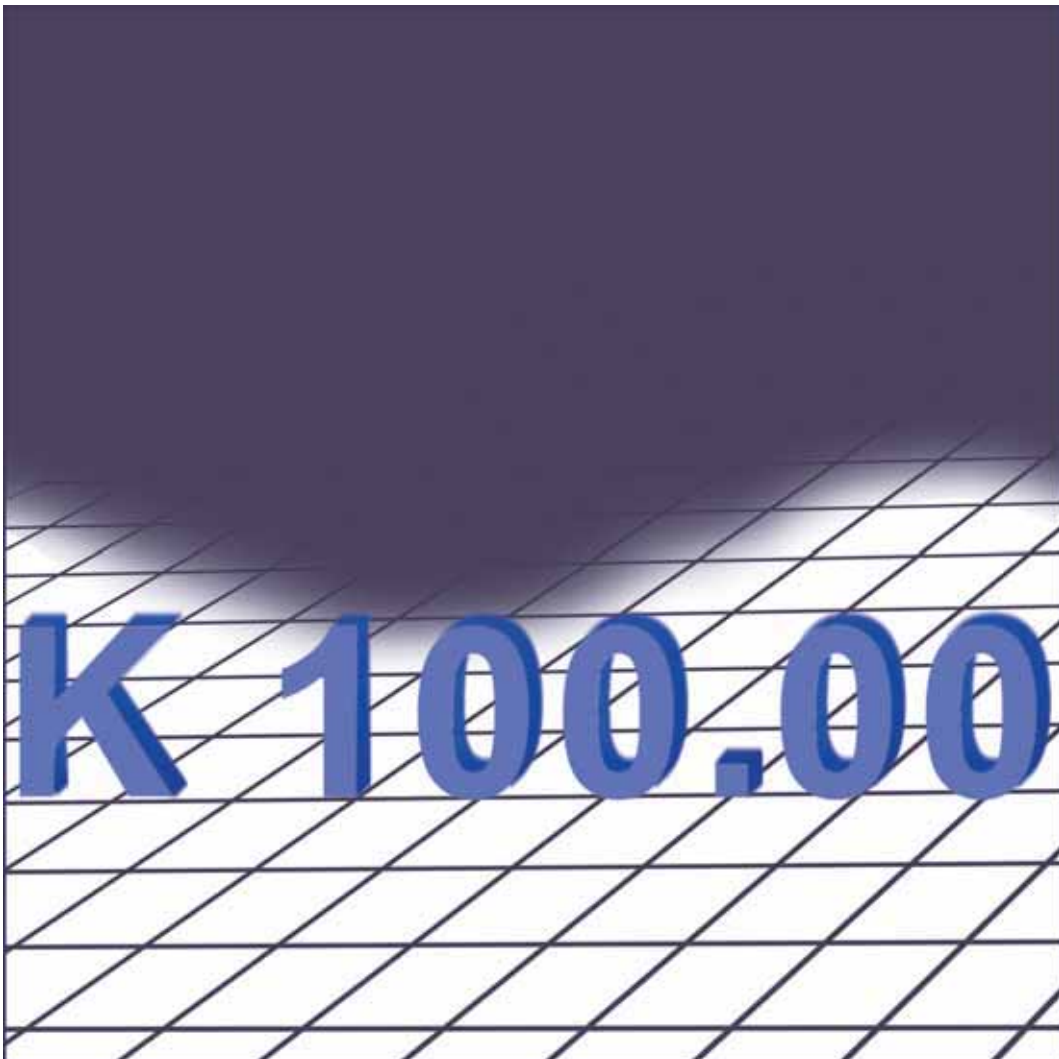

Kat. No. Cat. No.	Sayfa. Page.	Kat. No. Cat. No.	Sayfa. Page.	Kat. No. Cat. No.	Sayfa. Page.	Kat. No. Cat. No.	Sayfa. Page.
A 201.00	2	C 311.05	11	C 448.00	15	D 107.00	22
A 202.00	2	C 312.02	9	C 449.00	15	D 108.00	22
A 610.01	2	C 312.03	9	C 449.01	15	D 109.00	22
A 620.01	2	C 312.04	9	C 450.00	15	D 110.00	22
A 620.03	2	C 312.05	9	C 450.01	15	D 113.00	22
A 908.00	205	C 312.06	9	C 451.00	15	D 125.00	23
A 908.30	205	C 313.01	11	C 452.00	15	D 126.00	23
A 909.00	205	C 313.02	11	C 454.00	16	D 127.00	23
A 909.30	205	C 313.03	11	C 455.00	16	D 128.00	23
		C 313.04	11	C 456.00	16	D 130.00	23
		C 313.05	11	C 457.00	16	D 130.01	23
B 018.00	4	C 314.01	10	C 458.00	16	D 130.02	23
B 030.00	6	C 314.02	10	C 458.01	16	D 131.00	23
B 030.01	6	C 314.03	10	C 459.00	16	D 131.01	23
B 030.02	6	C 314.04	10	C 459.01	16	D 131.02	23
B 034.00	6	C 315.01	10	C 459.02	16	D 133.00	23
B 034.01	6-153	C 315.02	10	C 460.00	17	D 204.00	24
B 038.00	184	C 315.03	10	C 461.00	17	D 205.00	24
B 040.00	7	C 315.04	10	C 462.00	17	D 207.00	24
B 040.01	7	C 410.00	12	C 462.01	17	D 215.02	24
B 040.02	7	C 411.00	12	C 463.00	18	D 215.03	24
B 043.00	7	C 412.00	12	C 463.01	18	D 215.04	24
B 043.01	7	C 413.00	12	C 464.00	18	D 220.01	24
B 102.03	4	C 416.00	12	C 467.00	18	D 220.02	24
B 102.08	4	C 418.00	12	C 467.01	18	D 223.00	24
B 110.00	5	C 418.01	12	C 468.00	18	D 224.00	24
B 112.00	5-153	C 419.00	12	C 468.01	18	D 225.02	24
B 113.00	5-153	C 420.00	13	C 470.00	19	D 225.03	24
B 116.00	152	C 420.01	13	C 470.01	19	D 226.00	24
B 120.00	4	C 420.02	13	C 470.02	19	D 226.01	24
B 124.00	4	C 421.00	13	C 472.00	19	D 240.00	25
B 610.01	168	C 421.01	13	C 474.00	19	D 240.01	25
		C 421.02	13	C 490.00	20	D 240.02	25
		C 422.00	13	C 491.00	20	D 240.03	25
C 112.00	8	C 422.01	13	C 492.00	20	D 240.04	25
C 113.00	8	C 422.02	13	C 600.00	170	D 240.05	25
C 116.00	8	C 422.03	13	C 602.00	170	D 240.06	25
C 117.00	8	C 423.00	13	C 603.00	170	D 240.07	25
C 120.00	8	C 423.01	13	C 603.01	170	D 247.00	25
C 121.00	8	C 423.02	13	C 604.00	171	D 262.00	26
C 124.00	8	C 423.03	13	C 604.01	171	D 262.01	26
C 125.00	8	C 440.01	14	C 610.00	171	D 262.02	26
C 140.00	8	C 440.02	14	C 612.02	171	D 262.03	26
C 141.00	8	C 441.00	14	C 613.02	171	D 263.00	26
C 142.00	8	C 441.01	14	C 649.00	184	D 263.01	26
C 145.00	8	C 441.02	14	C 740.00	21	D 263.02	26
C 310.01	9	C 442.01	14	C 740.01	21	D 263.03	26
C 310.02	9	C 443.00	14	C 742.00	21	D 266.00	26
C 310.03	9	C 443.01	14	C 743.00	21	D 266.01	26
C 310.04	9	C 444.00	14			D 266.02	26
C 310.05	9	C 445.00	14	D 103.00	22	D 268.00	26
C 311.01	11	C 446.00	15	D 103.01	22	D 268.01	26
C 311.02	11	C 446.01	15	D 104.00	22	D 322.00	27
C 311.03	11	C 447.00	15	D 105.00	22	D 323.00	27
C 311.04	11	C 447.01	15	D 106.00	22	D 340.00	27

Kat. No. Cat. No.	Sayfa. Page.	Kat. No. Cat. No.	Sayfa. Page.	Kat. No. Cat. No.	Sayfa. Page.	Kat. No. Cat. No.	Sayfa. Page.
D 360.01	27	E 056.00	33	E 215.02	145	E 567.02	173
D 360.02	27	E 057.00	33	E 216.02	145	E 569.02	174
D 360.03	27	E 058.00	33	E 217.02	145	E 570.01	151
D 360.04	27	E 059.00	33	E 251.00	141	E 571.02	174
D 360.05	27	E 070.00	34	E 253.01	141	E 572.02	174
D 360.06	27	E 071.00	34	E 255.01	141	E 573.02	174
D 360.07	27	E 072.00	34	E 258.01	140	E 575.02	151
D 360.08	27	E 084.00	35	E 260.01	142	E 577.02	151
D 361.01	27	E 085.00	35	E 262.01	142	E 578.04	175
D 361.02	27	E 086.00	35	E 265.01	142	E 579.04	175
D 361.03	27	E 087.00	35	E 270.01	140	E 590.01	176
D 363.00	27	E 089.00	35	E 354.00	138	E 594.02	176
D 363.01	27	E 112.01	201	E 355.00	138	E 598.02	176
D 364.00	28	E 112.02	201	E 360.02	138	E 700.01	177
D 368.00	28	E 120.00	147	E 362.02	138	E 700.02	177
D 369.00	28	E 122.00	147	E 364.02	139	E 700.03	177
D 370.00	28	E 130.00	148	E 365.02	139	E 702.01	177
D 370.01	28	E 130.01	148	E 367.02	139	E 702.02	177
D 370.02	28	E 143.00	36	E 369.02	139	E 703.03	177
D 370.03	28	E 144.00	36	E 375.01	143	E 705.01	177
D 370.04	28	E 145.00	36	E 376.01	143	E 705.02	177
D 371.00	28	E 147.01	36	E 378.02	144	E 710.02	179
D 371.01	28	E 147.03	37	E 379.02	144	E 720.02	178
D 371.02	28	E 150.00	36	E 380.02	143	E 721.02	178
D 373.00	28	E 150.02	36	E 380.03	143	E 722.02	178
D 503.00	29	E 150.04	36	E 380.04	143	E 730.02	179
D 504.00	29	E 150.06	36	E 381.02	143	E 731.02	179
D 510.00	29	E 150.08	36	E 381.04	143	E 735.02	181
D 510.01	29	E 158.00	37	E 382.02	143	E 740.02	179
D 512.00	29	E 159.00	37	E 382.04	143		
D 512.01	29	E 165.00	145	E 383.02	144		
D 516.00	29	E 170.00	39	E 387.02	168	F 112.00	42
D 516.01	29	E 171.00	39	E 389.02	168	F 113.00	42
D 516.02	29	E 171.01	38	E 391.01	137	F 114.00	42
D 518.00	29	E 171.02	38	E 392.01	137	F 115.00	42
		E 174.00	38	E 430.00	41	F 116.00	42
		E 174.01	38	E 430.01	41	F 117.00	42
E 014.00	30	E 180.00	39	E 430.02	41	F 124.00	42
E 015.00	30	E 182.00	38	E 439.00	41	F 125.00	42
E 016.00	30	E 184.00	40	E 442.00	41	F 126.00	42
E 017.00	30	E 184.01	40	E 444.00	140	F 127.00	42
E 022.00	30	E 186.00	39	E 445.01	140	F 132.00	42
E 023.00	30	E 187.00	40	E 480.00	41	F 133.00	42
E 025.00	30	E 187.01	40	E 481.00	41	F 134.00	42
E 026.00	30	E 189.00	40	E 550.01	149	F 135.00	42
E 030.00	30	E 190.00	35	E 551.01	149	F 138.00	42
E 031.00	30	E 196.00	148	E 555.00	172	F 206.00	43
E 042.00	31	E 198.00	147	E 556.00	172	F 210.00	43
E 043.00	31	E 200.00	144	E 557.02	172	F 215.00	43
E 044.00	31	E 201.00	144	E 557.04	172	F 217.00	43
E 045.00	31	E 202.00	144	E 558.02	173	F 219.00	43
E 050.00	32	E 206.00	145	E 559.02	173	F 221.00	43
E 051.00	32	E 208.00	146	E 560.01	150	F 230.00	44
E 054.00	32	E 210.00	146	E 561.01	150	F 230.01	44
E 055.00	32	E 211.00	146	E 565.02	173	F 230.02	44

Kat. No. Cat. No.	Sayfa. Page.	Kat. No. Cat. No.	Sayfa. Page.	Kat. No. Cat. No.	Sayfa. Page.	Kat. No. Cat. No.	Sayfa. Page.
F 231.00	44	G 011.01	52	G 424.00	55	G 741.00	61
F 231.01	44	G 011.02	52	G 427.00	55	G 750.00	62
F 231.02	44	G 012.00	52	G 427.01	55	G 751.00	62
F 232.00	44	G 013.00	52	G 427.02	55	G 752.00	62
F 285.00	44	G 013.01	52	G 427.03	55	G 753.00	62
F 285.01	44	G 020.00	52	G 428.00	55	G 754.00	62
F 285.02	44	G 020.01	52	G 428.01	55	G 755.00	62
F 290.00	44	G 021.00	52	G 428.02	55	G 756.00	62
F 290.01	44	G 021.01	52	G 428.03	55	G 757.00	62
F 347.00	45	G 022.00	52	G 430.00	57	G 760.00	63
F 347.01	45	G 023.00	52	G 430.01	57	G 766.00	63
F 347.02	45	G 024.00	52	G 430.02	57	G 770.00	64
F 353.00	49	G 024.01	52	G 431.00	57	G 771.00	65
F 355.00	45	G 024.02	52	G 431.01	57	G 780.00	184
F 355.01	45	G 024.03	52	G 431.02	57	G 803.00	3
F 355.02	45	G 024.04	52	G 438.00	56	G 883.00	3
F 356.00	45	G 024.05	52	G 439.00	56	G 884.00	3
F 357.00	45	G 024.06	52	G 440.01	56	G 884.01	3
F 357.01	45	G 026.00	52	G 441.00	56	G 884.02	3
F 360.02	46	G 030.00	52	G 444.00	56		
F 361.02	46	G 030.01	52	G 445.00	56		
F 363.02	46	G 200.00	53	G 448.00	57	H 200.00	64
F 370.00	47	G 201.00	53	G 448.01	57	H 200.01	64
F 370.01	47	G 204.00	53	G 448.02	57	H 200.02	64
F 370.02	47	G 205.00	53	G 449.00	57	H 204.00	65
F 371.00	47	G 206.00	53	G 449.01	57	H 204.01	65
F 371.01	47	G 207.00	53	G 449.02	57	H 810.01	205
F 392.02	48	G 210.00	53	G 690.00	58	H 810,02	205
F 393.00	48	G 211.00	53	G 691.00	58		
F 393.01	48	G 214.00	53	G 692.00	58		
F 394.00	48	G 215.00	53	G 692.01	58	J 010.00	66
F 394.01	48	G 218.00	53	G 693.00	58	J 010.01	66
F 396.00	48	G 219.00	53	G 694.00	58	J 010.02	66
F 397.00	49	G 220.00	53	G 695.00	58	J 012.00	66
F 424.00	50	G 221.00	53	G 696.00	59	J 013.00	66
F 425.00	50	G 226.00	53	G 697.00	59	J 015.00	66
F 434.00	50	G 227.00	53	G 698.00	59	J 018.00	66
F 435.00	50	G 230.00	54	G 700.00	59	J 020.00	66
F 440.00	50	G 231.00	54	G 701.00	59	J 020.01	66
F 441.00	50	G 234.00	54	G 701.01	59	J 020.02	66
F 480.00	51	G 235.00	54	G 710.00	59	J 020.03	66
F 481.00	51	G 240.00	54	G 718.01	60	J 024.00	66
F 482.00	51	G 241.00	54	G 719.01	60	J 030.00	67
F 483.00	51	G 244.00	54	G 721.00	60	J 030.01	67
F 484.00	51	G 245.00	54	G 722.00	60	J 030.02	67
F 485.00	51	G 250.00	54	G 722.01	60	J 030.03	67
F 488.00	51	G 251.00	54	G 723.00	60	J 030.04	67
F 489.00	51	G 254.00	54	G 723.01	60	J 033.01	67
F 542.01	183	G 255.00	54	G 730.00	60	J 033.07	67
F 542.03	183	G 420.00	55	G 730.01	60	J 033.08	67
		G 420.01	55	G 732.00	61	J 033.09	67
G 010.00	52	G 421.00	55	G 733.00	61	J 033.10	67
G 010.01	52	G 421.01	55	G 734.00	61	J 033.11	67
G 010.02	52	G 423.00	55	G 736.00	61	J 033.12	67
G 011.00	52	G 423.01	55	G 740.00	61	J 033.15	67

Kat. No. Cat. No.	Sayfa. Page.	Kat. No. Cat. No.	Sayfa. Page.	Kat. No. Cat. No.	Sayfa. Page.	Kat. No. Cat. No.	Sayfa. Page.
J 033.16	67	J 151.04	199-204	J 162.02	199	J 652.05	135
J 033.17	67	J 151.05	199-204	J 162.03	199	J 652.08	135
J 033.18	67	J 151.06	199-204	J 162.04	199	J 653.05	135
J 033.20	67	J 152.01	199-204	J 162.05	199	J 656.05	135
J 035.00	67	J 152.02	199-204	J 163.01	199	J 658.05	135
J 035.01	67	J 152.03	199-204	J 163.02	199	J 750.01	132
J 035.02	67	J 152.04	199-204	J 163.03	199	J 750.02	132
J 037.00	67	J 152.05	199-204	J 163.04	199	J 750.03	132
J 038.00	67	J 153.01	199-204	J 163.05	199	J 750.04	132
J 038.01	67	J 153.02	199-204	J 164.01	199	J 750.05	132
J 039.00	67	J 153.03	199-204	J 164.02	199	J 750.06	132
J 040.00	67	J 153.04	199-204	J 164.03	199	J 750.07	132
J 040.01	67	J 153.05	199-204	J 164.04	199	J 750.08	132
J 040.02	67	J 154.01	199-204	J 164.05	199	J 750.09	132
J 041.00	67	J 154.02	199-204	J 165.01	199	J 750.10	132
J 063.00	136	J 154.03	199-204	J 165.02	199	J 750.11	132
J 068.03	136	J 154.04	199-204	J 165.03	199	J 750.12	132
J 069.00	67	J 154.05	199-204	J 165.04	199	J 750.13	132
J 095.06	134	J 155.01	199-204	J 165.05	199	J 750.14	132
J 095.07	134	J 155.02	199-204	J 171.01	200	J 750.15	132
J 095.08	134	J 155.03	199-204	J 171.02	200	J 750.16	132
J 095.09	134	J 155.04	199-204	J 171.03	200	J 750.17	132
J 095.10	134	J 155.05	199-204	J 171.04	200	J 750.18	132
J 095.11	134	J 156.01	199-204	J 171.05	200	J 750.19	132
J 095.12	134	J 156.02	199-204	J 171.06	200	J 750.20	132
J 095.13	134	J 156.03	199-204	J 171.07	200	J 750.21	132
J 095.14	134	J 156.04	199-204	J 172.00	200	J 750.22	132
J 095.15	134	J 156.05	199-204	J 172.01	200	J 750.23	132
J 095.16	134	J 157.01	199-204	J 172.02	200	J 750.24	132
J 095.18	134	J 157.02	199-204	J 173.00	200	J 750.25	132
J 095.20	134	J 157.03	199-204	J 346.01	137	J 750.26	132
J 140.01	203	J 157.04	199-204	J 346.02	137	J 751.01	132
J 140.02	203	J 157.05	199-204	J 346.03	137	J 751.02	132
J 140.03	203	J 158.01	199	J 347.01	137	J 751.03	132
J 140.04	203	J 158.02	199	J 347.02	137	J 751.04	132
J 141.01	203	J 158.03	199	J 347.03	137	J 751.05	132
J 141.02	203	J 158.04	199	J 451.00	167	J 751.06	132
J 141.03	203	J 158.05	199	J 451.01	167	J 751.07	132
J 141.04	203	J 159.01	199	J 451.02	167	J 751.08	132
J 142.01	203	J 159.02	199	J 451.03	167	J 751.09	132
J 142.02	203	J 159.03	199	J 451.04	167	J 751.10	132
J 142.03	203	J 159.04	199	J 451.05	167	J 751.11	132
J 142.04	203	J 159.05	199	J 458.00	167	J 751.12	132
J 142.05	203	J 160.01	199	J 480.03	169	J 751.13	132
J 142.06	203	J 160.02	199	J 480.04	169	J 751.14	132
J 142.07	203	J 160.03	199	J 480.05	169	J 790.00	132
J 142.08	203	J 160.04	199	J 480.10	169	J 790.01	132
J 150.03	199-204	J 160.05	199	J 490.00	167	J 792.00	132
J 150.04	199-204	J 161.00	200	J 490.01	167	J 952.00	201
J 150.05	199-204	J 161.01	199	J 490.02	167	J 961.01	183
J 150.06	199-204	J 161.02	199	J 490.03	167		
J 150.07	199-204	J 161.03	199	J 490.04	167		
J 151.01	199-204	J 161.04	199	J 498.08	167	K 221.00	68
J 151.02	199-204	J 161.05	199	J 498.10	167	K 223.00	68
J 151.03	199-204	J 162.01	199	J 650.05	135	K 238.00	68

Kat. No. Cat. No.	Sayfa. Page.	Kat. No. Cat. No.	Sayfa. Page.	Kat. No. Cat. No.	Sayfa. Page.	Kat. No. Cat. No.	Sayfa. Page.
K 238.01	68	K 460.03	74	K 684.03	126	K 758.01	88
K 238.02	68	K 460.04	74	K 700.01	84	K 758.02	88
K 272.00	68	K 461.00	74	K 700.02	84	K 758.03	88
K 274.00	68	K 461.01	74	K 700.03	84	K 758.04	88
K 274.02	68	K 461.02	74	K 701.00	85	K 760.00	89
K 276.00	68	K 490.00	75	K 702.02	85	K 762.00	89
K 276.01	68	K 490.01	75	K 702.03	85	K 764.00	89
K 295.02	168	K 490.02	75	K 705.01	124	K 766.00	89
K 310.00	69	K 491.00	75	K 705.02	124	K 804.01	116
K 311.00	69	K 492.00	76	K 705.03	124	K 804.02	116
K 312.00	69	K 492.01	76	K 705.04	124	K 804.03	116
K 314.00	69	K 494.00	76	K 705.05	124	K 806.01	116
K 315.00	69	K 494.01	76	K 705.06	124	K 807.01	116
K 317.00	69	K 494.02	76	K 705.07	124	K 807.02	116
K 320.00	70	K 520.01	184	K 705.08	124	K 807.03	116
K 320.01	70	K 523.01	183	K 705.09	124	K 809.02	116
K 320.02	70	K 608.00	77	K 705.12	124	K 809.03	116
K 325.00	70	K 608.01	77	K 705.14	124	K 809.04	116
K 325.01	70	K 608.02	77	K 706.01	125	K 809.05	116
K 325.02	70	K 608.03	77	K 706.02	125	K 809.06	116
K 325.03	70	K 610.01	127	K 706.03	125	K 812.00	117
K 327.00	71	K 612.01	127	K 707.00	124	K 812.01	117
K 327.01	71	K 614.01	127	K 709.00	86	K 812.02	117
K 342.00	71	K 614.02	127	K 710.00	86	K 812.03	117
K 348.00	71	K 660.01	78	K 715.01	87	K 812.04	118
K 432.00	72	K 660.02	78	K 715.02	87	K 812.05	118
K 432.01	72	K 660.03	78	K 715.03	87	K 812.06	118
K 432.02	72	K 660.04	78	K 715.04	87	K 812.07	118
K 432.03	72	K 660.05	78	K 715.05	87	K 812.08	118
K 432.04	72	K 660.06	79	K 735.01	129	K 813.01	121
K 433.00	72	K 660.07	79	K 735.08	129	K 814.00	117
K 433.01	72	K 660.08	79	K 735.09	129	K 814.01	117
K 433.02	72	K 660.09	79	K 735.10	129	K 814.02	117
K 433.03	72	K 668.04	80	K 735.11	129	K 814.03	117
K 433.04	72	K 668.05	80	K 735.12	129	K 814.04	118
K 434.00	72	K 668.06	80	K 735.15	129	K 814.05	118
K 434.02	72	K 668.07	81	K 735.16	129	K 814.06	118
K 434.03	72	K 668.08	81	K 735.20	129	K 814.07	118
K 435.00	72	K 670.00	82	K 735.21	129	K 814.08	118
K 435.01	72	K 670.02	82	K 735.22	129	K 817.02	120
K 435.02	72	K 672.00	83	K 735.23	129	K 817.03	120
K 435.03	72	K 673.00	83	K 735.24	129	K 817.04	120
K 436.00	72	K 680.02	126	K 735.25	129	K 819.02	120
K 436.01	72	K 680.04	126	K 735.26	129	K 819.03	120
K 436.02	72	K 682.02	126	K 735.27	129	K 819.04	120
K 436.03	72	K 682.03	126	K 735.30	129	K 825.01	121
K 440.00	73	K 682.04	126	K 742.00	97	K 826.01	121
K 442.00	73	K 682.05	126	K 752.00	88	K 830.01	122
K 444.00	73	K 682.06	126	K 752.01	88	K 830.05	122
K 444.01	73	K 683.02	126	K 752.02	88	K 832.01	122
K 444.02	73	K 683.03	126	K 754.00	88	K 832.05	122
K 444.03	73	K 683.04	126	K 756.00	88	K 832.08	122
K 460.00	74	K 683.05	126	K 756.01	88	K 841.00	119
K 460.01	74	K 683.06	126	K 756.02	88	K 841.01	119
K 460.02	74	K 684.02	126	K 758.00	88	K 841.02	119

Kat. No. Cat. No.	Sayfa. Page.	Kat. No. Cat. No.	Sayfa. Page.	Kat. No. Cat. No.	Sayfa. Page.	Kat. No. Cat. No.	Sayfa. Page.
K 841.03	119	L 527.01	182	L 605.10	102	L 620.50	107-110
K 841.04	119	L 528.00	93	L 605.20	102-103	L 620.51	107-110
K 841.05	119	L 530.00	94	L 605.22	102-103	L 620.55	107-110
K 841.06	119	L 531.01	94	L 605.25	102-103	L 620.56	107-110
K 841.07	119	L 531.02	94	L 605.27	102-103	L 620.57	107-110
K 841.08	119	L 532.01	95	L 605.28	102-103	L 620.58	107-110
K 843.01	122	L 534.00	95	L 605.30	102-103	L 620.59	107-110
K 844.01	122	L 534.01	95	L 605.33	103	L 620.60	107-110
K 850.01	123	L 534.02	95	L 605.35	103	L 620.62	107-110
K 851.01	123	L 534.03	95	L 605.40	102-103	L 620.64	107-110
K 856.01	123	L 534.20	95	L 608.00	105	L 620.70	111
K 857.01	123	L 560.00	90-91-92	L 608.01	105	L 620.71	111
K 860.01	128	L 560.01	90-92	L 608.04	105	L 620.72	111
K 860.02	128	L 560.02	90-92	L 608.06	105	L 620.75	111
K 860.03	128	L 560.03	90-92	L 608.15	105	L 620.76	111
K 860.04	128	L 560.04	90-92	L 608.17	105	L 620.77	111
K 862.01	128	L 560.05	91-92	L 608.30	105	L 620.80	111
K 863.01	128	L 560.06	91-92	L 608.31	105	L 620.81	111
K 863.02	128	L 560.07	91-92	L 608.50	105	L 630.10	96
K 868.01	128	L 560.10	95	L 608.52	105	L 630.11	96-101
K 868.02	128	L 560.11	95	L 608.54	105	L 630.13	96-101
K 868.03	128	L 560.12	95	L 608.56	105	L 630.15	96
		L 560.13	95	L 608.58	105	L 630.17	96
L 408.00	130	L 580.00	90	L 608.64	105	L 630.19	96
L 409.00	130	L 580.03	90	L 608.66	105	L 630.22	97-101
L 412.00	130	L 580.04	90	L 608.68	105	L 630.23	97-101
L 413.01	130	L 580.05	90	L 610.00	106	L 630.24	97-101
L 417.00	131	L 580.08	91	L 610.02	106	L 630.25	97-101
L 418.00	131	L 580.10	91	L 610.05	106	L 630.27	97-101
L 418.01	131	L 580.11	91	L 610.20	106	L 630.29	97-101
L 418.03	131	L 580.16	91	L 610.25	106	L 630.30	98-101
L 418.04	131	L 580.22	93	L 610.30	106	L 630.31	98-101
L 418.05	131	L 580.23	95	L 610.35	106	L 630.32	98-101
L 500.00	90	L 580.25	94-95	L 620.00	107	L 630.34	98-101
L 501.00	90	L 580.26	94-95	L 620.02	107	L 630.37	98-101
L 501.01	90	L 580.27	94-95	L 620.05	107-108	L 630.38	98
L 502.00	90	L 580.30	95	L 620.08	107-108	L 630.40	98
L 502.01	90	L 580.40	95	L 620.10	107-108	L 630.42	99
L 502.04	90	L 590.00	182	L 620.12	108	L 630.43	99
L 503.01	90	L 590.01	182	L 620.15	107-108	L 630.45	99-101
L 503.02	90	L 600.00	104	L 620.17	107-108	L 630.46	99-101
L 503.03	90	L 600.01	104	L 620.18	107-108	L 630.48	99
L 503.06	90	L 600.10	104	L 620.30	107-109	L 630.49	99
L 503.07	90	L 600.20	104	L 620.31	109	L 630.51	99
L 505.00	91	L 600.40	104	L 620.32	109	L 630.52	99
L 505.01	91	L 600.42	104	L 620.33	109	L 630.53	99
L 506.00	91	L 600.44	104	L 620.35	107-109	L 630.54	99
L 506.01	91	L 600.46	104	L 620.36	107-109	L 630.60	100-101
L 506.04	91	L 600.48	104	L 620.37	107-109	L 630.62	100-101
L 508.00	91	L 602.00	104	L 620.40	109	L 630.64	100-101
L 508.01	91	L 602.01	104	L 620.41	109	L 630.65	100
L 521.00	182	L 605.00	102	L 620.42	109	L 630.66	100
L 523.00	182	L 605.01	102	L 620.45	107-110	L 630.68	100
L 525.00	93	L 605.02	102	L 620.47	107-110	L 630.69	100
L 525.01	182	L 605.03	102	L 620.48	107-110	L 630.70	100

Kat. No. Cat. No.	Sayfa. Page.	Kat. No. Cat. No.	Sayfa. Page.	Kat. No. Cat. No.	Sayfa. Page.	Kat. No. Cat. No.	Sayfa. Page.
L 630.72	100-101	N 502.08	162	N 534.19	164	R 770.00	161
L 630.74	100	N 502.09	162	N 534.21	164	R 770.01	161
L 630.77	100-101	N 502.10	162	N 540.16	164	R 772.00	161
L 630.80	101	N 502.11	162	N 540.20	164	R 774.00	161
L 630.81	101	N 510.06	162	N 540.23	164	R 795.00	161
L 630.83	101	N 510.08	162	N 540.27	164	R 796.00	161
L 630.84	101	N 510.10	162	N 540.31	164	R 830.02	159
L 750.01	115	N 510.12	162	N 540.36	164	R 830.05	159
L 752.01	112	N 510.14	162	N 540.41	164	R 842.05	136
L 754.01	112	N 520.04	163	N 550.34	165	S 040.00	184
L 754.02	112	N 520.08	163	N 550.44	165		
L 754.03	112	N 520.09	163	N 552.24	165	T 400.01	134
L 754.04	112	N 520.12	163	N 552.35	165	T 401.01	134
L 760.01	112	N 520.15	163	N 554.24	165	T 408.01	136
L 762.01	113	N 520.19	163	N 554.30	165	T 420.00	152
L 762.02	113	N 520.21	163	N 554.35	165	T 421.00	152
L 762.04	113	N 520.24	163	N 560.05	166	T 425.00	170
L 763.01	113	N 520.27	163	N 565.04	166	T 430.01	180
L 763.02	113	N 520.30	163	N 570.08	166	T 435.01	180
L 763.03	113	N 520.34	163	N 580.02	154	T 436.01	180
L 765.01	113	N 520.38	163	N 581.02	154	T 440.02	181
L 765.02	113	N 525.09	163	N 585.01	154	T 790.00	129
L 765.04	113	N 525.12	163	N 588.02	154	T 791.00	129
L 770.01	112	N 525.15	163	N 590.06	155	T 870.00	183
L 771.01	113	N 525.19	163	N 590.12	155	T 905.05	201
L 771.02	113	N 525.21	163	N 590.18	155	T 905.10	201
L 771.03	113	N 525.27	163	N 595.04	155	T 490.00	184
L 771.04	113	N 525.30	163	N 595.05	155		
L 780.01	114	N 528.08	163	N 595.06	155	X 100.01	190
L 781.01	114	N 528.09	163			X 100.03	190
L 781.05	114	N 528.12	163			X 101.01	190
L 782.01	114	N 528.15	163	R 390.03	136	X 101.03	190
L 782.05	114	N 528.19	163	R 395.03	136	X 102.01	190
L 783.01	114	N 528.21	163	R 700.02	156	X 102.03	190
L 785.01	115	N 528.24	163	R 705.02	156	X 102.05	190
L 785.02	115	N 528.27	163	R 710.01	156	X 103.01	190
L 785.03	115	N 528.30	163	R 710.03	156	X 103.03	190
L 790.01	115	N 528.34	163	R 715.01	157	X 103.05	190
L 790.02	115	N 528.38	163	R 715.02	157	X 104.03	190
L 790.03	115	N 530.07	164	R 717.01	157	X 105.01	190
L 791.01	115	N 530.09	164	R 717.02	157	X 105.03	190
L 791.02	115	N 530.12	164	R 718.01	157	X 106.01	190
		N 530.15	164	R 730.02	158	X 106.03	190
		N 530.19	164	R 730.04	158	X 107.03	190
M 691.01	184	N 530.21	164	R 732.02	158	X 108.01	190
		N 532.07	164	R 734.02	158	X 108.03	190
		N 532.09	164	R 740.02	159	X 108.05	190
N 500.06	162	N 532.12	164	R 742.02	159	X 109.01	190
N 500.07	162	N 532.15	164	R 750.01	160	X 109.03	190
N 500.08	162	N 532.19	164	R 750.03	160	X 110.03	190
N 500.09	162	N 532.21	164	R 752.01	160	X 111.01	190
N 500.10	162	N 534.07	164	R 752.03	160	X 111.03	190
N 500.11	162	N 534.09	164	R 760.05	161	X 111.05	190
N 502.06	162	N 534.12	164	R 762.01	161	X 112.01	190
N 502.07	162	N 534.15	164	R 762.02	161	X 112.03	190

Kat. No. Cat. No.	Sayfa. Page.	Kat. No. Cat. No.	Sayfa. Page.	Kat. No. Cat. No.	Sayfa. Page.	Kat. No. Cat. No.	Sayfa. Page.
X 113.01	190	X 141.02	191	X 160.02	192	X 187.02	194
X 113.03	190	X 141.03	191	X 160.03	192	X 187.04	194
X 114.01	190	X 141.04	191	X 160.04	192	X 189.01	194
X 114.03	190	X 141.05	191	X 161.02	192	X 189.02	194
X 114.05	190	X 142.01	191	X 162.01	192	X 189.03	194
X 115.01	190	X 142.02	191	X 162.02	192	X 189.04	194
X 116.01	190	X 142.03	191	X 162.03	192	X 189.05	194
X 118.01	190	X 142.05	191	X 162.04	192	X 190.02	194
X 119.01	190	X 144.01	191	X 162.05	192	X 192.02	194
X 121.01	190	X 144.02	191	X 163.02	193	X 192.05	194
X 123.01	190	X 144.03	191	X 165.02	193	X 193.02	194
X 123.03	190	X 144.05	191	X 165.05	193	X 195.02	194
X 123.05	190	X 145.01	191	X 166.02	193	X 195.05	194
X 124.01	191	X 145.02	191	X 168.02	193	X 196.02	194
X 124.02	191	X 145.03	191	X 168.05	193	X 198.02	194
X 124.03	191	X 145.05	191	X 169.01	193	X 198.05	194
X 125.01	191	X 146.01	191	X 169.02	193	X 199.02	194
X 125.03	191	X 146.02	191	X 169.04	193	X 201.02	194
X 126.01	191	X 146.03	191	X 171.01	193	X 201.05	194
X 126.02	191	X 146.05	191	X 171.02	193	X 202.02	194
X 126.03	191	X 147.01	191	X 171.03	193	X 204.02	194
X 126.05	191	X 147.02	191	X 171.04	193	X 204.05	194
X 127.01	191	X 147.03	191	X 171.05	193	X 205.03	195
X 127.02	191	X 147.05	191	X 172.02	193	X 207.03	195
X 127.03	191	X 148.02	192	X 172.04	193	X 207.05	195
X 128.01	191	X 148.04	192	X 174.01	193	X 208.02	195
X 128.03	191	X 149.02	192	X 174.02	193	X 210.02	195
X 129.01	191	X 150.01	192	X 174.04	193	X 210.05	195
X 129.02	191	X 150.02	192	X 174.05	193	X 211.02	195
X 129.03	191	X 150.03	192	X 175.02	193	X 213.02	195
X 129.05	191	X 150.04	192	X 175.04	193	X 213.05	195
X 130.01	191	X 150.05	192	X 177.01	193	X 214.03	195
X 130.02	191	X 151.02	192	X 177.02	193	X 215.03	195
X 130.03	191	X 151.04	192	X 177.03	193	X 216.03	195
X 131.01	191	X 152.02	192	X 177.04	193	X 216.05	195
X 131.03	191	X 153.01	192	X 177.05	193	X 217.01	195
X 132.01	191	X 153.02	192	X 178.01	193	X 220.03	196
X 132.02	191	X 153.03	192	X 178.02	193	X 222.01	196
X 132.03	191	X 153.04	192	X 178.04	193	X 222.02	196
X 132.05	191	X 153.05	192	X 180.01	193	X 222.03	196
X 133.02	191	X 154.02	192	X 180.02	193	X 222.04	196
X 133.05	191	X 154.04	192	X 180.03	193	X 222.05	196
X 134.02	191	X 155.02	192	X 180.04	193	X 223.02	196
X 135.01	191	X 156.01	192	X 180.05	193	X 225.01	196
X 135.02	191	X 156.02	192	X 181.01	194	X 225.02	196
X 135.03	191	X 156.03	192	X 181.02	194	X 225.03	196
X 135.05	191	X 156.04	192	X 181.04	194	X 225.04	196
X 136.01	191	X 156.05	192	X 183.01	194	X 225.05	196
X 136.03	191	X 157.02	192	X 183.02	194	X 183.02	194
X 138.01	191	X 157.04	192	X 183.03	194	X 183.03	194
X 138.02	191	X 159.01	192	X 183.04	194	X 183.04	194
X 138.03	191	X 159.02	192	X 183.05	194	X 183.05	194
X 138.05	191	X 159.03	192	X 184.02	194	X 184.02	194
X 139.02	191	X 159.04	192	X 186.02	194	X 186.02	194
X 141.01	191	X 159.05	192	X 186.04	194	X 186.04	194

Kat. No. Cat. No.	Sayfa. Page.	Kat. No. Cat. No.	Sayfa. Page.	Kat. No. Cat. No.	Sayfa. Page.	Kat. No. Cat. No.	Sayfa. Page.
X 187.02	194	X 515.01	195	X 707.01	198	Y 111.26	208
X 187.04	194	X 518.02	195	X 707.02	198	Y 112.10	209
X 189.01	194	X 520.02	195	X 750.00	197	Y 112.13	209
X 189.02	194	X 520.05	195	X 751.01	198	Y 112.15	209
X 189.03	194	X 521.01	195	X 751.02	198	Y 112.20	209
X 189.04	194	X 521.03	195			Y 112.26	209
X 189.05	194	X 523.01	195			Y 113.10	209
X 189.04	194	X 523.03	195	Y 095.00	224	Y 113.13	209
X 189.05	194	X 523.05	195	Y 095.01	223-224	Y 113.15	209
X 226.02	196	X 524.01	196	Y 095.02	224	Y 113.20	209
X 228.01	196	X 524.03	196	Y 095.03	224	Y 113.26	209
X 228.02	196	X 526.01	196	Y 095.04	219-221	Y 115.15	226
X 228.03	196	X 526.03	196	Y 095.05	219-221	Y 120.10	208
X 228.04	196	X 526.05	196	Y 095.06	219	Y 120.13	208
X 228.05	196	X 527.01	197	Y 095.07	211-219	Y 120.15	208
X 229.02	196	X 527.03	197	Y 095.08	211-219	Y 120.20	208
X 231.01	196	X 529.01	197	Y 095.09	211	Y 120.26	208
X 231.02	196	X 529.03	197	Y 095.10	211	Y 121.10	208
X 231.03	196	X 529.05	197	Y 100.01	210	Y 121.13	208
X 231.04	196	X 530.01	197	Y 100.02	210	Y 121.15	208
X 231.05	196	X 530.03	197	Y 100.03	210	Y 121.20	208
X 232.01	196	X 532.01	197	Y 100.04	210	Y 121.26	208
X 234.01	196	X 532.03	197	Y 100.05	210	Y 122.10	209
X 234.02	196	X 532.05	197	Y 100.06	210	Y 122.13	209
X 234.03	196	X 533.01	197	Y 102.01	226	Y 122.15	209
X 234.05	196	X 535.01	197	Y 102.02	226	Y 122.20	209
X 235.01	196	X 535.03	197	Y 102.03	226	Y 122.26	209
X 237.01	196	X 535.05	197	Y 102.04	226	Y 123.10	209
X 237.02	196	X 536.01	197	Y 102.05	226	Y 123.13	209
X 237.03	196	X 536.03	197	Y 102.06	226	Y 123.15	209
X 237.05	196	X 538.01	197	Y 103.01	210	Y 123.20	209
X 238.01	196	X 538.03	197	Y 103.02	210	Y 123.26	209
X 240.01	196	X 538.05	197	Y 103.03	210	Y 125.15	226
X 240.02	196	X 615.02	197	Y 103.04	210	Y 130.10	208
X 240.03	196	X 617.02	197	Y 103.05	210	Y 130.13	208
X 240.05	196	X 617.05	197	Y 103.06	210	Y 130.15	208
X 500.01	192	X 690.01	189	Y 105.10	210	Y 130.20	208
X 500.03	192	X 690.02	189	Y 105.13	210	Y 130.26	208
X 502.01	192	X 690.03	189	Y 105.15	210	Y 131.10	208
X 502.03	192	X 690.04	189	Y 105.20	210	Y 131.13	208
X 502.05	192	X 691.01	189	Y 105.26	210	Y 131.15	208
X 503.01	192	X 691.02	189	Y 106.10	210	Y 131.20	208
X 503.03	192	X 691.03	189	Y 106.13	210	Y 131.26	208
X 505.01	192	X 691.04	189	Y 106.15	210	Y 132.10	209
X 505.03	192	X 700.00	198	Y 106.20	210	Y 132.13	209
X 505.05	192	X 700.01	198	Y 106.26	210	Y 132.15	209
X 506.01	192	X 700.02	198	Y 110.10	132-133-208	Y 132.20	209
X 506.03	192	X 701.01	198	Y 110.13	133-208	Y 132.26	209
X 507.01	192	X 701.02	198	Y 110.15	133-208	Y 133.10	209
X 507.03	192	X 702.01	198	Y 110.20	133-208	Y 133.13	209
X 508.01	192	X 702.02	198	Y 110.26	133-208	Y 133.15	209
X 508.03	192	X 705.01	198	Y 111.10	208	Y 133.20	209
X 508.05	192	X 705.02	198	Y 111.13	208	Y 133.26	209
X 509.01	193	X 706.01	198	Y 111.15	208	Y 135.15	226
X 512.01	193	X 706.02	198	Y 111.20	101-208	Y 140.10	208

Kat. No. Cat. No.	Sayfa. Page.	Kat. No. Cat. No.	Sayfa. Page.	Kat. No. Cat. No.	Sayfa. Page.	Kat. No. Cat. No.	Sayfa. Page.
Y 140.13	208	Y 163.20	209	Y 223.15	213	Y 300.01	218
Y 140.15	208	Y 163.26	209	Y 230.10	212	Y 300.02	218
Y 140.20	208	Y 165.15	226	Y 230.13	212	Y 300.03	218
Y 140.26	208	Y 190.03	211	Y 230.15	212	Y 300.04	218
Y 141.10	208	Y 190.05	211	Y 231.10	212	Y 300.05	218
Y 141.13	208	Y 190.07	211	Y 231.13	212	Y 300.06	218
Y 141.15	208	Y 190.10	211	Y 231.15	212	Y 302.01	226
Y 141.20	208	Y 191.03	133-211	Y 232.10	213	Y 302.02	226
Y 141.26	208	Y 191.05	101-132	Y 232.13	213	Y 302.03	226
Y 142.10	209	Y 191.05	133- 211	Y 232.15	213	Y 302.04	226
Y 142.13	209	Y 191.07	133-211	Y 233.10	213	Y 302.05	226
Y 142.15	209	Y 191.10	133-211	Y 233.13	213	Y 302.06	226
Y 142.20	209	Y 193.00	133-211	Y 233.15	213	Y 303.01	218
Y 142.26	209	Y 195.00	211	Y 240.10	212	Y 303.02	218
Y 143.10	209	Y 200.01	214	Y 240.13	212	Y 303.03	218
Y 143.13	209	Y 200.02	214	Y 240.15	212	Y 303.04	218
Y 143.15	209	Y 200.03	214	Y 241.10	212	Y 303.05	218
Y 143.20	209	Y 200.04	214	Y 241.13	212	Y 303.06	218
Y 143.26	209	Y 200.05	214	Y 241.15	212	Y 304.01	221
Y 145.15	226	Y 200.06	214	Y 242.10	213	Y 304.02	221
Y 150.10	208	Y 203.01	214	Y 242.13	213	Y 304.03	221
Y 150.13	208	Y 203.02	214	Y 242.15	213	Y 304.04	221
Y 150.15	208	Y 203.03	214	Y 243.10	213	Y 304.05	221
Y 150.20	208	Y 203.04	214	Y 243.13	213	Y 305.05	221
Y 150.26	208	Y 203.05	214	Y 243.15	213	Y 305.08	221
Y 151.10	208	Y 203.06	214	Y 250.10	212	Y 305.10	218-226
Y 151.13	208	Y 205.10	214	Y 250.13	212	Y 305.13	218
Y 151.15	208	Y 205.13	214	Y 250.15	212	Y 305.15	218-226
Y 152.15	209	Y 205.15	214	Y 251.10	212	Y 305.20	218
Y 152.20	209	Y 206.10	214	Y 251.13	212	Y 305.26	218
Y 152.26	209	Y 206.13	214	Y 251.15	212	Y 306.08	221
Y 153.10	209	Y 206.15	214	Y 252.10	213	Y 306.10	218
Y 153.13	209	Y 210.10	212	Y 252.13	213	Y 306.13	218
Y 153.15	209	Y 210.13	212	Y 252.15	213	Y 306.15	218
Y 153.20	209	Y 210.15	212	Y 253.10	213	Y 306.20	218
Y 153.26	209	Y 211.10	212	Y 253.13	213	Y 306.26	218
Y 155.15	226	Y 211.13	212	Y 253.15	213	Y 310.05	220
Y 160.10	208	Y 211.15	212	Y 260.10	212	Y 310.08	220
Y 160.13	208	Y 212.10	213	Y 260.13	212	Y 310.10	132-133-216
Y 160.15	208	Y 212.13	213	Y 260.15	212	Y 310.13	133-216
Y 160.20	208	Y 212.15	213	Y 261.10	212	Y 310.15	133-216
Y 160.26	208	Y 213.10	213	Y 261.13	212	Y 310.20	133-216
Y 161.10	208	Y 213.13	213	Y 261.15	212	Y 310.26	133-216
Y 161.13	208	Y 213.15	213	Y 262.10	213	Y 311.08	220
Y 161.15	208	Y 220.10	212	Y 262.13	213	Y 311.10	216
Y 161.20	208	Y 220.13	212	Y 262.15	213	Y 311.13	216
Y 161.26	208	Y 220.15	212	Y 263.10	213	Y 311.15	216
Y 162.10	209	Y 221.10	212	Y 263.13	213	Y 311.20	216
Y 162.13	209	Y 221.13	212	Y 263.15	213	Y 311.26	216
Y 162.15	209	Y 221.15	212	Y 290.03	215	Y 312.10	217
Y 162.20	209	Y 222.10	213	Y 290.05	215	Y 312.13	217
Y 162.26	209	Y 222.13	213	Y 290.07	215	Y 312.15	217
Y 163.10	209	Y 222.15	213	Y 290.10	215	Y 312.20	217
Y 163.13	209	Y 223.10	213	Y 293.03	215	Y 312.26	217
Y 163.15	209	Y 223.13	213	Y 295.00	215	Y 313.10	217

Kat. No. Cat. No.	Sayfa. Page.	Kat. No. Cat. No.	Sayfa. Page.	Kat. No. Cat. No.	Sayfa. Page.	Kat. No. Cat. No.	Sayfa. Page.
Y 313.13	217	Y 335.15	226	Y 360.26	216	Y 440.04	222
Y 313.15	217	Y 340.05	220	Y 361.10	216	Y 440.07	222
Y 313.20	217	Y 340.08	220	Y 361.13	216	Y 440.10	222
Y 313.26	217	Y 340.10	216	Y 361.15	216	Y 441.04	222
Y 315.10	226	Y 340.13	216	Y 361.20	216	Y 441.07	222
Y 315.15	226	Y 340.15	216	Y 361.26	216	Y 441.10	222
Y 320.05	220	Y 340.20	216	Y 362.10	217	Y 450.04	222
Y 320.08	220	Y 340.26	216	Y 362.13	217	Y 450.07	222
Y 320.10	216	Y 341.08	220	Y 362.15	217	Y 450.10	222
Y 320.13	216	Y 341.10	216	Y 362.20	217	Y 451.04	222
Y 320.15	216	Y 341.13	216	Y 362.26	217	Y 451.07	222
Y 320.20	216	Y 341.15	216	Y 363.10	217	Y 451.10	222
Y 320.26	216	Y 341.20	216	Y 363.13	217	Y 495.00	223
Y 321.08	220	Y 341.26	216	Y 363.15	217	Y 500.01	224
Y 321.10	216	Y 342.10	217	Y 363.20	217	Y 506.04	224
Y 321.13	216	Y 342.13	217	Y 363.26	217	Y 506.06	224
Y 321.15	216	Y 342.15	217	Y 365.10	226	Y 506.13	224
Y 321.20	216	Y 342.20	217	Y 365.15	226	Y 600.01	225
Y 321.26	216	Y 342.26	217	Y 390.03	133-219-221	Y 600.02	225
Y 322.10	217	Y 343.10	217	Y 390.05	132-133	Y 610.06	225
Y 322.13	217	Y 343.13	217	Y 390.05	219-221	Y 612.07	225
Y 322.15	217	Y 343.15	217	Y 390.07	133-219	Y 620.06	225
Y 322.20	217	Y 343.20	217	Y 390.10	133-219	Y 622.07	225
Y 322.26	217	Y 343.26	217	Y 393.00	133-219-221	Y 630.06	225
Y 323.10	217	Y 345.10	226	Y 395.00	219	Y 632.07	225
Y 323.13	217	Y 345.15	226	Y 400.01	223	Y 640.06	225
Y 323.15	217	Y 350.05	220	Y 400.02	223	Y 642.07	225
Y 323.20	217	Y 350.08	220	Y 400.03	223	Y 650.06	225
Y 323.26	217	Y 350.10	216	Y 400.04	223	Y 652.07	225
Y 325.10	226	Y 350.13	216	Y 400.05	223	Y 800.00	228
Y 325.15	226	Y 350.15	216	Y 405.04	223	Y 800.01	228
Y 330.05	220	Y 350.20	216	Y 405.07	223	Y 801.00	228
Y 330.08	220	Y 350.26	216	Y 405.10	223	Y 802.00	228
Y 330.10	216	Y 351.08	220	Y 406.04	223	Y 802.01	228
Y 330.13	216	Y 351.10	216	Y 406.07	223	Y 804.00	228
Y 330.15	216	Y 351.13	216	Y 406.10	223	Y 804.01	228
Y 330.20	216	Y 351.15	216	Y 410.04	222	Y 809.00	228
Y 330.26	216	Y 351.20	216	Y 410.07	222	Y 809.01	228
Y 331.08	220	Y 351.26	216	Y 410.10	222	Y 810.00	228
Y 331.10	216	Y 352.10	217	Y 410.30	222	Y 812.00	228
Y 331.13	216	Y 352.13	217	Y 411.04	222	Y 819.00	228
Y 331.15	216	Y 352.15	217	Y 411.07	222	Y 820.01	228
Y 331.20	216	Y 352.20	217	Y 411.10	222	Y 820.02	228
Y 331.26	216	Y 352.26	217	Y 420.04	222	Y 820.03	228
Y 332.10	217	Y 353.10	217	Y 420.07	222	Y 820.04	228
Y 332.13	217	Y 353.13	217	Y 420.10	222	Y 820.05	228
Y 332.15	217	Y 353.15	217	Y 421.04	222	Y 820.06	228
Y 332.20	217	Y 353.20	217	Y 421.07	222	Y 829.00	228
Y 332.26	217	Y 353.26	217	Y 421.10	222	Y 830.00	229
Y 333.10	217	Y 355.10	226	Y 430.04	222	Y 830.01	229
Y 333.13	217	Y 355.15	226	Y 430.07	222	Y 831.05	229
Y 333.15	217	Y 360.10	216	Y 430.10	222	Y 831.13	229
Y 333.20	217	Y 360.13	216	Y 431.04	222	Y 831.22	229
Y 333.26	217	Y 360.15	216	Y 431.07	222	Y 831.46	229
Y 335.10	226	Y 360.20	216	Y 431.10	222	Y 840.00	229

Kat. No. Cat. No.	Sayfa. Page.	Kat. No. Cat. No.	Sayfa. Page.
Y 841.00	133-229	Z 301.06	202
Y 841.01	133-229	Z 302.02	202
Y 842.00	133-229	Z 303.01	202
Y 842.01	229	Z 303.02	202
Y 845.00	229	Z 303.03	202
Y 847.00	229	Z 303.04	202
Y 849.00	229	Z 303.05	202
Y 850.00	223	Z 303.06	202
Y 851.00	221	Z 304.01	202
Y 880.00	227	Z 304.02	202
Y 880.01	227	Z 304.03	202
Y 880.02	227	Z 304.04	202
Y 880.03	227	Z 304.05	202
Y 880.04	227	Z 304.06	202
Y 890.00	230	Z 305.02	202
Y 891.00	230	Z 309.00	187
Z 001.00	185		
Z 002.00	185		
Z 003.00	185		
Z 004.00	185		
Z 005.00	185		
Z 006.00	185		
Z 009.00	185		
Z 010.00	185		
Z 012.00	185		
Z 015.00	185		
Z 015.01	185		
Z 015.02	185		
Z 016.00	185		
Z 016.01	185		
Z 016.02	185		
Z 040.00	186		
Z 041.00	186		
Z 043.00	186		
Z 043.01	186		
Z 044.00	186		
Z 044.01	186		
Z 044.02	186		
Z 045.00	186		
Z 046.00	187		
Z 048.00	187		
Z 050.00	187		
Z 050.01	187		
Z 050.02	187		
Z 060.00	187		
Z 065.00	187		
Z 095.00	185		
Z 096.00	185		
Z 097.00	185		
Z 300.01	202		
Z 300.02	202		
Z 300.03	202		
Z 300.04	202		



BAHADIR TIBBİ ALETLER SANAYİ VE TİCARET A.Ş.
BAHADIR MEDICAL EQUIPMENT INDUSTRY AND TRADE CO.
Organize Sanayi 55300 / Kutlukent / SAMSUN / TURKEY
Tel : +90 (362) 266 70 00 (PBX) Fax : +90 (362) 266 70 05
Url: www.bahadir.com E-mail: info@bahadir.com.tr